

Discontinuation Notice of E5EN series (For china area only)

Product Discontinuation

Basic-type Digital Temperature Controller



Model E5EN series



Recommended Replacement

Digital Temperature Controller

Model E5EC series
Some models have no replacements.

[Discontinuation date]

The end of March, 2017

[Caution on recommended replacement]

When replacing models, Sysway Protocol is rendered unavailable.

There is a change in the terminals from M3.5 to M3, and the number of terminals in one array from 10 to 12. There is no big change in the terminal arrangement.

The temperature sensor with M4 terminals cannot be connected directly to E5EC. You need to attach new crimp terminals.

Draw out function is not provided. If draw out function is needed, please contact your sales representative.

When replacing models, be sure that communications with RS-232C is unavailable.

When using communications with RS-232C, be sure to connect with interface converter K3SC series.

[Difference from discontinued product]

Recommended replacement Model	Body Color	Dimensions	Wire connection	Mounting Dimensions	Characteristics	Operation ratings	Operation methods
Model E5EC series	*	--	--	*	--	*	*

** : Compatible

* : The change is a little/Almost compatible

-- : Not compatible

- : No corresponding specification

E5EC does not support the specification of E5EN-Y□□□ (long-life relay output).

E5EC does not support the specification of E5EN-□□P□ (power supply for ES1B).

E5EC does not support the specification of E5EN-□□□-W (body color: silver).



The recommended replacement has the body color black.

[Product Discontinuation and recommended replacement]

Product discontinuation	Recommended replacement
E5EN-RQ3T-N	E5EC-QR4ASM-000
E5EN-RQ3BT-N	E5EC-QR4ASM-010
E5EN-R3HT-W-N	E5EC-RX4ASM-010
E5EN-R3HT-N	E5EC-RX4ASM-010
E5EN-R3HTD-N	E5EC-RX4DSM-010
E5EN-R3HL-N	E5EC-RX4ASM-010
E5EN-R3HHT-N	E5EC-RX4ASM-009
E5EN-R3HHBT-W-N	E5EC-RX4ASM-009
E5EN-R3HHBT-N	E5EC-RX4ASM-009
E5EN-R3HBT-W-N	E5EC-RX4ASM-010
E5EN-R3HBT-N	E5EC-RX4ASM-010
E5EN-R3HBTD-W-N	E5EC-RX4DSM-010
E5EN-R3HBTD-N	E5EC-RX4DSM-010
E5EN-R3HBL-N	E5EC-RX4ASM-010
E5EN-R3H03T-W-FLK-N	E5EC-RX4ASM-008
E5EN-R3H03T-FLK-N	E5EC-RX4ASM-008
E5EN-R3H03TD-FLK-N	E5EC-RX4DSM-008
E5EN-R3H01T-W-FLK-N	E5EC-RX4ASM-008 Use it with the interface convertor model K3SC-10 connected.
E5EN-R3H01T-FLK-N	E5EC-RX4ASM-008 Use it with the interface convertor model K3SC-10 connected.
E5EN-R3H01TD-FLK-N	E5EC-RX4DSM-008 Use it with the interface convertor model K3SC-10 connected.
E5EN-R3FT-N	E5EC-RX4ASM-011
E5EN-R3FL-N	E5EC-RX4ASM-011
E5EN-R1T-W-N	E5EC-RX2ASM-000
E5EN-R1T-N	E5EC-RX2ASM-000
E5EN-QQ3T-N	E5EC-QQ4ASM-000
E5EN-QQ3BT-N	E5EC-QQ4ASM-010
E5EN-Q3HT-W-N	E5EC-QX4ASM-010
E5EN-Q3HT-N	E5EC-QX4ASM-010
E5EN-Q3HTD-N	E5EC-QX4DSM-010
E5EN-Q3HL-N	E5EC-QX4ASM-010
E5EN-Q3HHT-N	E5EC-QX4ASM-009
E5EN-Q3HHBT-W-N	E5EC-QX4ASM-009
E5EN-Q3HHBT-N	E5EC-QX4ASM-009
E5EN-Q3HHBBT-N	E5EC-QX4ASM-009 Alternative replacement: E5EC-QX4ASM-010
E5EN-Q3HHBBL-N	E5EC-QX4ASM-009 Alternative replacement: E5EC-QX4ASM-010
E5EN-Q3HBT-W-N	E5EC-QX4ASM-010
E5EN-Q3HBT-N	E5EC-QX4ASM-010
E5EN-Q3HBTD-W-N	E5EC-QX4DSM-010
E5EN-Q3HBTD-N	E5EC-QX4DSM-010
E5EN-Q3HBL-N	E5EC-QX4ASM-010
E5EN-Q3H03T-W-FLK-N	E5EC-QX4ASM-008
E5EN-Q3H03T-FLK-N	E5EC-QX4ASM-008
E5EN-Q3H03TD-FLK-N	E5EC-QX4DSM-008

Product discontinuation	Recommended replacement
E5EN-Q3H01T-W-FLK-N	E5EC-QX4ASM-008 Use it with the interface convertor model K3SC-10 connected.
E5EN-Q3H01T-FLK-N	E5EC-QX4ASM-008 Use it with the interface convertor model K3SC-10 connected.
E5EN-Q3H01TD-FLK-N	E5EC-QX4DSM-008 Use it with the interface convertor model K3SC-10 connected.
E5EN-Q1T-W-N	E5EC-QX2ASM-000
E5EN-Q1T-N	E5EC-QX2ASM-000
E5EN-Q1TD-N	E5EC-QX2DSM-000
E5EN-CQ3BT-N	E5EC-QX4ASM-010
E5EN-C3T-W-N	E5EC-CX4ASM-000
E5EN-C3T-N	E5EC-CX4ASM-000
E5EN-C3TD-N	E5EC-CX4DSM-000
E5EN-C3L-N	E5EC-CX4ASM-000
E5EN-C3BT-W-N	E5EC-CX4ASM-005
E5EN-C3BT-N	E5EC-CX4ASM-005
E5EN-C3BTD-W-N	E5EC-CX4DSM-005
E5EN-C3BTD-N	E5EC-CX4DSM-005
E5EN-C3BL-N	E5EC-CX4ASM-005
E5EN-C3BBT-N	E5EC-CX4ASM-005
E5EN-C3BBL-N	E5EC-CX4ASM-005
E5EN-C3BBFT-N	E5EC-CX4ASM-013
E5EN-C3BBFL-N	E5EC-CX4ASM-013
E5EN-C303T-W-FLK-N	E5EC-CX4ASM-004
E5EN-C303T-FLK-N	E5EC-CX4ASM-004
E5EN-C303TD-FLK-N	E5EC-CX4DSM-004
E5EN-C301T-W-FLK-N	E5EC-CX4ASM-004 Use it with the interface convertor model K3SC-10 connected.
E5EN-C301T-FLK-N	E5EC-CX4ASM-004 Use it with the interface convertor model K3SC-10 connected.
E5EN-C301TD-FLK-N	E5EC-CX4DSM-004 Use it with the interface convertor model K3SC-10 connected.
E5EN-C1T-W-N	E5EC-CX2ASM-000
E5EN-C1T-N	E5EC-CX2ASM-000
E5EN-RY3T-N	No recommended replacement
E5EN-RY3BT-N	No recommended replacement
E5EN-RY3BL-N	No recommended replacement
E5EN-R3PT-N	No recommended replacement
E5EN-R3PBT-N	No recommended replacement
E5EN-QY3T-N	No recommended replacement
E5EN-QY3BT-N	No recommended replacement
E5EN-QY3BL-N	No recommended replacement
E5EN-Q3PT-N	No recommended replacement
E5EN-Q3PBT-N	No recommended replacement
E5EN-CY3T-N	No recommended replacement
E5EN-CY3BT-N	No recommended replacement
E5EN-CY3BL-N	No recommended replacement

[Body color]

<p>Product discontinuation Model E5EN series</p>	<p>Recommendable replacement Model E5EC series</p>
<p>Housing color black silver</p> <p>Appearance and height of characters</p>  <p>Height of characters PV: 11.8 mm, SV: 8.1 mm, MV: 5.8 mm</p> <p>Indicator color: PV in red (color switches to green and orange), SV in green, MV in yellow</p>	<p>Housing color black only</p> <p>Appearance and height of characters</p>  <p>Height of characters PV: 18 mm, SV: 11 mm, MV: 7.8 mm</p> <p>Indicator color: PV in white, SV in green, MV in yellow</p>

[Wire connection]

Product discontinuation
Model E5EN series

Terminal arrangement

- 100 to 240 VAC
- 24 VAC/VDC (no polarity)

Control output 1

Relay output
250 VAC, 5A
(resistive load)
Voltage output
(for driving SSR)
12 VDC, 40 mA
Current output
0 to 20 mA DC
4 to 20 mA DC
Load: 600 Ω max.

Control output 2

Voltage output
(for driving SSR)
12 VDC, 21 mA
Long-life relay output
250 VAC, 3 A
(resistive load)

**Auxiliary output
1, 2, 3**

Relay outputs
250 VAC, 3 A
(resistive load)

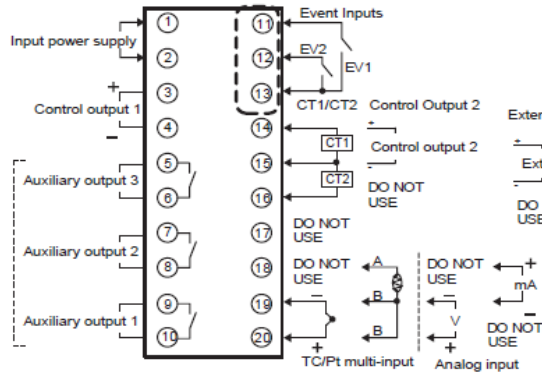

Communications		
E53-EN01 RS-232C	E53-EN03 RS-485	E53-AKB Event inputs
⑪—SD	⑪—B (+)	⑪—EV
⑫—RD	⑫—A (-)	⑫—EV
⑬—SG	⑬—DO NOT USE	⑬—CT1/CT2

External Power Supply
External power supply
12 VDC, 20 mA
DO NOT USE

A heater burnout alarm, heater short alarm, heater overcurrent alarm, or input alarm is sent to the output to which the alarm 1 function is assigned.

Wiring connection

Attach a crimp terminal as a terminal.
Use an M3.5 crimp terminal of the following shape.

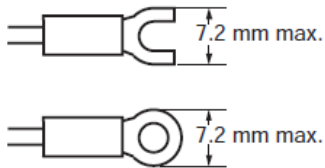

**Recommended replacement
Model E5EC series**

Terminal arrangement

The terminal numbers and crimp terminal sizes differ from those of E5EN.

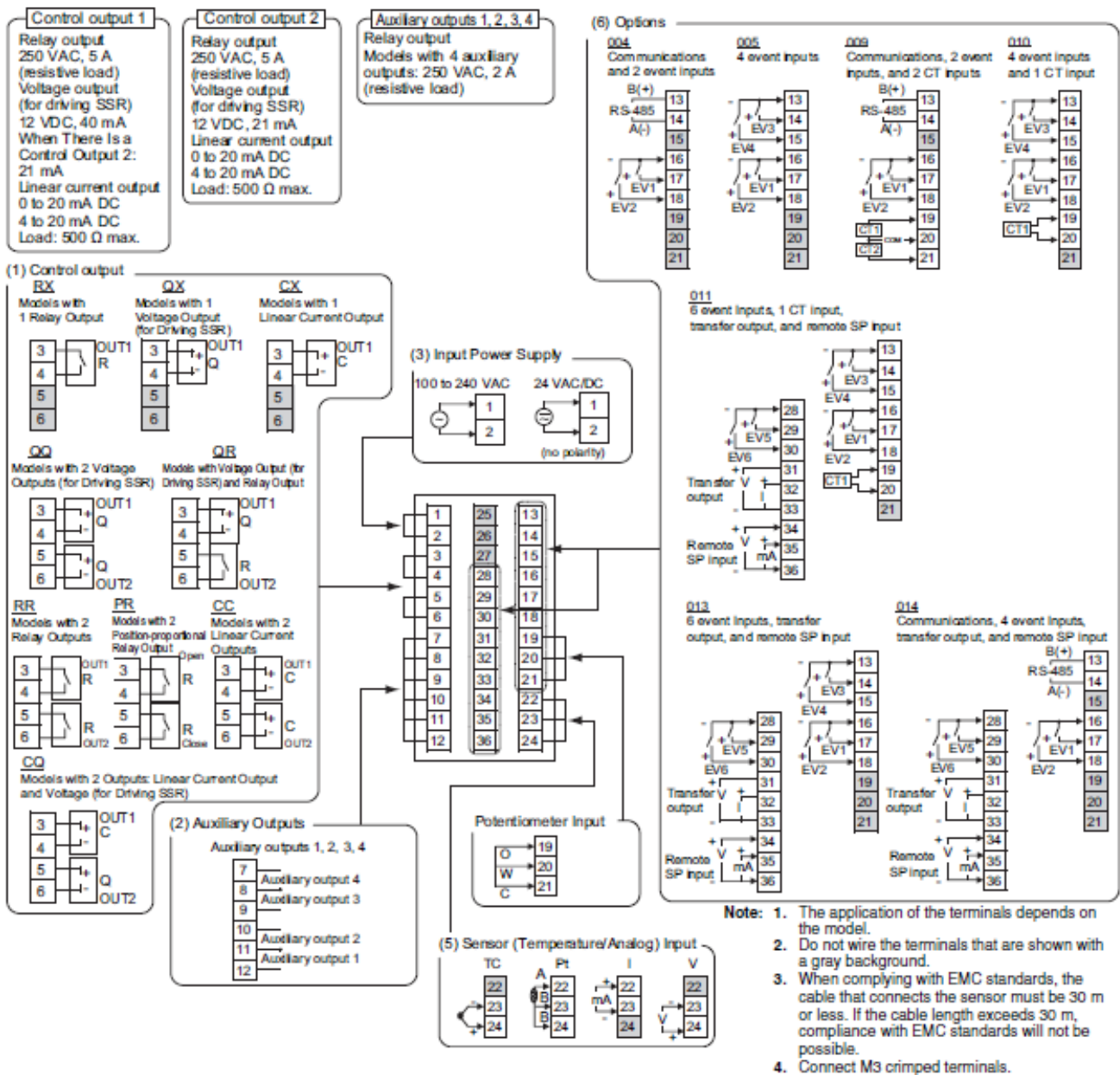

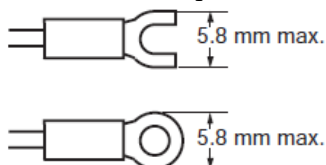

Wiring connection

Attach a crimp terminal as a terminal.
Use an M3 crimp terminal of the following shape.



[Mounting dimensions]

<p>Product discontinuation Model E5EN series</p>	<p>Recommendable replacement Model E5EC series</p>
<div data-bbox="311 331 622 891" data-label="Image"> </div> <div data-bbox="172 900 670 1411" data-label="Image"> </div> <div data-bbox="151 1451 794 1572" data-label="Text"> <p>Waterproof Packing (Accessory) Mounting Bracket (Accessory) Terminal Cover (E53-COV16) (Accessory)</p> <p>Crimp terminal size: M3.5</p> </div> <div data-bbox="183 1617 678 1747" data-label="Text"> <p>Depth: 79.2 mm Weight: approx. 260 g (Body only) Possible to mount closely side-by-side. Possible to have draw-out replacement.</p> </div> <div data-bbox="124 1803 459 1870" data-label="Text"> <p>Mounting Bracket (Two Adapters provided)</p> </div> <div data-bbox="207 1870 542 2049" data-label="Image"> </div>	<div data-bbox="901 273 1388 336" data-label="Text"> <p>There is no change in the panel cutout dimensions.</p> </div> <div data-bbox="997 347 1308 900" data-label="Image"> </div> <div data-bbox="1061 936 1412 1444" data-label="Image"> </div> <div data-bbox="901 1451 1316 1534" data-label="Text"> <p>Waterproof Packing (Accessory) Mounting Adapter (Accessory)</p> </div> <div data-bbox="901 1617 1444 1747" data-label="Text"> <p>Depth: 60 mm Weight: approx. 210 g (Body only) Possible to mount closely side-by-side. Not possible to have draw-out replacement</p> </div> <div data-bbox="845 1803 1292 1870" data-label="Text"> <p>Mounting Adapter Y92F-51 (Two Adapters provided)</p> </div> <div data-bbox="917 1892 1189 2049" data-label="Image"> </div>

<p align="center">Product discontinuation Model E5EN series</p>	<p align="center">Recommendable replacement Model E5EC series</p>
<p>Waterproof Packing Y92S-P5 (for DIN48 × 96)</p> 	<p>Waterproof Packing Y92S-P9 (for DIN48 × 96)</p> 

[Ratings]

Item		Product discontinuation Model E5EN series	Recommended replacement Model E5EC series
Power consumption		100 to 240 VAC: 10 VA 24 VAC/VDC: 5.5 VA (24 VAC)/4 W (24 VDC)	Models with option selection of 000: 6.6 VA max. at 100 to 240 VAC, and 4.1 VA max. at 24 VAC or 2.3 W max. at 24 VDC All other models: 8.3 VA max. at 100 to 240 VAC, and 5.5 VA max. at 24 VAC or 3.2 W max. at 24 VDC
Input impedance		Current input: 150 Ω max., Voltage input: 1 MΩ minimum.	Current input: 150 Ω max., Voltage input: 1 MΩ minimum.
Control outputs	Relay output	SPST-NO, 250 VAC, 5 A (resistive load), Electrical life: 100,000 operations, Minimum applicable load: 5 V, 10 mA	SPST-NO, 250 VAC, 5 A (resistive load), Electrical life: 100,000 operations, Minimum applicable load: 5 V, 10 mA (reference value)
	Voltage output (for driving SSR)	Output voltage: 12 VDC ±15% (PNP), Max. load current: 40 mA, With short-circuit protection circuit: Max. Load current of 21 mA for control output 2	Output voltage: 12 VDC ±20% (PNP), Max. load current: 40 mA, With short-circuit protection circuit (The maximum load current is 21 mA for models with two control outputs.)
	Current output	4 to 20 mA DC/0 to 20 mA DC, Load: 600 Ω max., Resolution: approx. 10,000	4 to 20 mA DC/0 to 20 mA DC, Load: 500Ω max., Resolution: approx. 10,000
	Long-life relay output	SPST-NO, 250 VAC, 3 A (resistive load), Electrical life: 1,000,000 operations, Load power supply voltage: 75 to 250 VAC (DC loads cannot be connected.), Minimum applicable load: 5 V, 10 mA, Leakage current: 5 mA max. (250 VAC, 60 Hz)	—
Auxiliary output	Number of outputs	3	4
	Output specifications	Relay output: SPST-NO, 250 VAC, 3 A (resistive load), Electrical life: 100,000 operations, Minimum applicable load: 5 V, 10 mA	SPST-NO. relay outputs, 250 VAC, Models with 4 outputs: 2 A (resistive load), Electrical life: 100,000 operations, Minimum applicable load: 10 mA at 5 V (reference value)
Event input	Number of inputs	2	2, 4 or 6 (depends on model)
	External contact input specification	Contact input: ON: 1 kΩ max., OFF: 100 kΩ minimum.	Contact input: ON: 1 kΩ max., OFF: 100 kΩ minimum.
		Non-contact input: ON: Residual voltage: 1.5 V max., OFF: Leakage current: 0.1 mA max.	Non-contact input: ON: Residual voltage: 1.5 V max., OFF: Leakage current: 0.1 mA max.
		Current flow: Approx. 7 mA per contact	Current flow: Approx. 7 mA per contact
External power supply for ES1B		12 VDC ±10%, 20 mA, short-circuit protection circuit provided	—
Remote SP input		—	Current input: 4 to 20 mA DC or 0 to 20 mA DC (input impedance: 150 Ω max.) Voltage input: 1 to 5 V, 0 to 5 V, or 0 to 10 V (input impedance: 1 MΩ minimum.)
Potentiometer input		—	100 Ω to 10 kΩ
Indication method		11-segment digital display and individual indicators (7-segments displays also possible) Character height: E5EN: PV: 11.8 mm, SV: 8.1 mm, MV: 5.8 mm Indicator color: PV in red (color switches to green and orange), SV in green, MV in yellow	11-segment digital display and individual indicators Character height: E5EC: PV: 18.0 mm, SV: 11.0 mm, MV: 7.8 mm Indicator color: PV in white, SV in green, MV in yellow
Multi SP function		Up to four set points (SP0 to SP3) can be saved and selected using event inputs, key operations, or serial communications.	Up to eight set points (SP0 to SP7) can be saved and selected using the event inputs, key operations, or serial communications.

<p>Other functions (change points)</p>	<p>—</p>	<p>Functions to be deleted Detecting heater overcurrent, Counting control output ON/OFF, Automatic adjustment of cooling coefficient, Switching indicator colors, Switching indicator characters</p> <p>Functions to be added Robust tuning, Moving average of inputs, Setting indicator luminance</p>
---	----------	--

[Characteristics]

Item	Product discontinuation Model E5EN series	Recommended replacement Model E5EC series
Input sampling cycle	250 ms	50 ms
Integral time (I)	0 to 3999 s (in units of 1 s)	Standard, heating/cooling, or Position-proportional (Close): 0 to 9999 s (in units of 1 s), 0.0 to 999.9 s (in units of 0.1 s) Position-proportional (Floating): 1 to 9999 s (in units of 1 s), 0.1 to 999.9 s (in units of 0.1 s)
Derivative time (D)	0 to 3999 s (in units of 1 s)	0 to 9999 s (in units of 1 s), 0.0 to 999.9 s (in units of 0.1 s)
Proportional band (P) for cooling	—	Temperature input: 0.1 to 999.9°C or °F (in units of 0.1°C or °F) Analog input: 0.1 to 999.9% FS (in units of 0.1% FS)
Integral time (I) for cooling	—	0 to 9999 s (in units of 1 s), 0.0 to 999.9 s (in units of 0.1 s)
Derivative time (D) for cooling	—	0 to 9999 s (in units of 1 s), 0.0 to 999.9 s (in units of 0.1 s)
Control cycle	0.5, 1 to 99 s (in units of 1 s)	0.1, 0.2, 0.5, 1 to 99 s (in units of 1 s)
Dielectric strength	2,300 VAC, 50 or 60 Hz for 1 min (between terminals with different charge)	3,000 VAC, 50/60 Hz for 1 min between terminals of different charge
Weight	Controller: Approx. 260 g, Mounting Bracket: Approx. 100 g	Controller: Approx. 210 g, Adapter: Approx. 4 g × 2
Setup tool	CX-Thermo version 4.0 or higher	CX-Thermo version 4.5 or higher
Setup Tool port	Provided on the bottom of the E5EN. An E58-CIFQ1 USB-Serial Conversion Cable is required to connect the computer to the E5EN	E5EC top panel: An E58-CIFQ2 USB-Serial Conversion Cable is used to connect to a USB port on the computer. E5EC front panel: An E58-CIFQ2 USB-Serial Conversion Cable and E58-CIFQ2-E Conversion Cable are used together to connect to a USB port on the computer.
Standards	Approved standards	UL 61010-1, CSA C22.2 No. 1010-1
		UL 61010-1, Korean Radio Waves Act (Act 10564)

[Communication performance]

Item	Product discontinuation Model E5EN series	Recommended replacement Model E5EC series
Connection of transmission path	RS-485: Multipoint RS-232C: Point-to-point	RS-485: Multidrop
Communication method	RS-485 (two-wire, half duplex) or RS-232C	RS-485 (two-wire, half duplex)
Protocol	CompoWay/F, Sysway, Modbus	CompoWay/F, Modbus
DTE speed	1200, 2400, 4800, 9600, 19200, 38400, 57600 bps	9600, 19200, 38400, 57600 bps
Error detection	Vertical parity (none, even, odd) Frame check sequence (FCS) with SYSWAY Block check character (BCC) with CompoWay/F or CRC-16 Modbus	Vertical parity (none, even, odd) Block check character (BCC) with CompoWay/F or CRC-16 Modbus
Interface	RS-485, RS-232C	RS-485
Other functions (change points)	—	Function to be added Program-less communications, Compo communications, Copying

[Operation ratings]

Product discontinuation
Model E5EN series

Input range

Thermocouple/Platinum Resistance Thermometer (Universal Inputs)

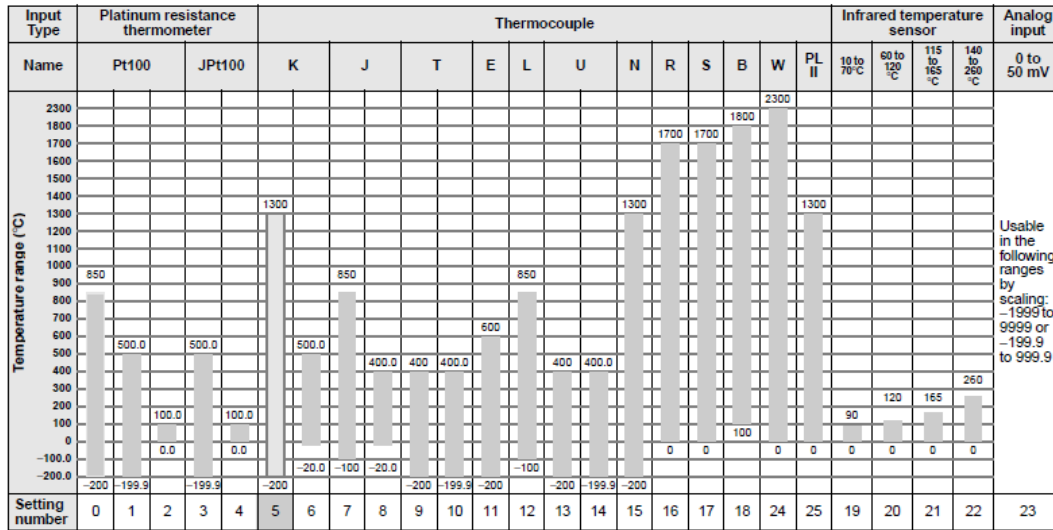

Models with Analog Inputs

Input Type	Current		Voltage		
Input specification	4 to 20mA	0 to 20 mA	1 to 5 V	0 to 5 V	0 to 10 V
Setting range	Usable in the following ranges by scaling: -199.9 to 999.9, -199.9 to 999.9, -19.99 to 99.99 or -1.999 to 9.999				
Setting number	0	1	2	3	4

Shaded settings are the default settings.

Recommended replacement
Model E5EC series

Input range

The set values 19 or higher for input ranges will be changed. Also, analog inputs of 0 to 50 mV range cannot be used.

● Thermocouple/Platinum Resistance Thermometer (Universal inputs)

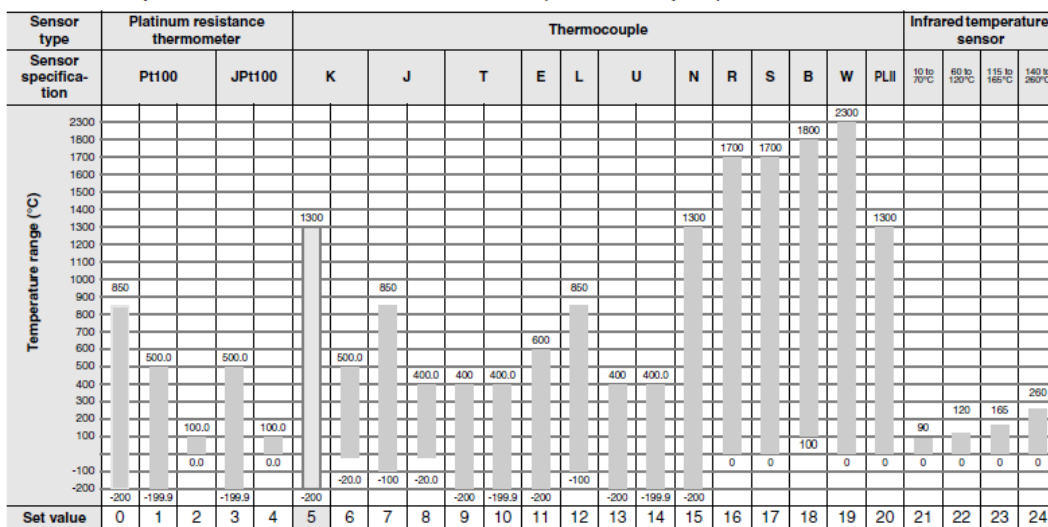

Shaded settings are the default settings.

● Analog input

Input type	Current		Voltage		
Input specification	4 to 20 mA	0 to 20 mA	1 to 5 V	0 to 5 V	0 to 10 V
Setting range	Usable in the following ranges by scaling: -199.9 to 999.9, -199.9 to 999.9, -19.99 to 99.99 or -1.999 to 9.999				
Set value	25	26	27	28	29

Product discontinuation
Model E5EN series

Alarm types

Each alarm can be independently set to one of the following 13 alarm types. The default is 2: *Upper limit*. Auxiliary outputs are allocated for alarms. ON delays and OFF delays (0 to 999 s) can also be specified.

Note: For models with heater burnout, SSR failure, and heater overcurrent detection, alarm 1 will be an OR output of the alarm selected from the following alarm types and the alarms for heater burnout, SSR failure, and heater overcurrent. To output only a heater burnout alarm, SSR failure alarm, and heater overcurrent alarm for alarm 1, set the alarm type to 0 (i.e., no alarm function).

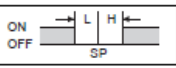
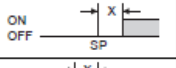
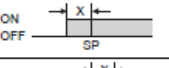
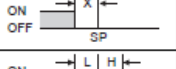
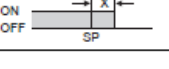
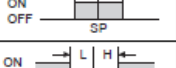
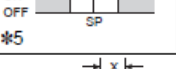
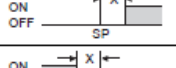
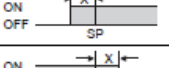
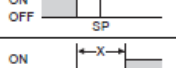
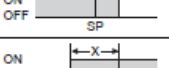
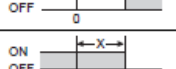
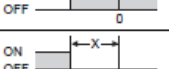
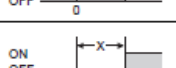
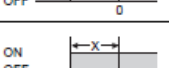
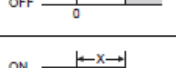
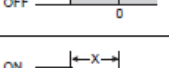
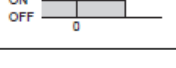
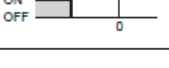
Set value	Alarm type	Alarm output operation	
		When X is positive	When X is negative
0	Alarm function OFF	Output OFF	
1 *1	Upper- and lower-limit	ON OFF 	*2
2	Upper limit	ON OFF 	ON OFF 
3	Lower limit	ON OFF 	ON OFF 
4 *1	Upper- and lower-limit range	ON OFF 	*3
5 *1	Upper- and lower-limit with standby sequence	ON OFF 	*4
6	Upper-limit with standby sequence	ON OFF 	ON OFF 
7	Lower-limit with standby sequence	ON OFF 	ON OFF 
8	Absolute-value upper-limit	ON OFF 	ON OFF 
9	Absolute-value lower-limit	ON OFF 	ON OFF 
10	Absolute-value upper-limit with standby sequence	ON OFF 	ON OFF 
11	Absolute-value lower-limit with standby sequence	ON OFF 	ON OFF 
12	LBA (for alarm 1 only)	---	
13	PV change rate alarm	---	

*1. With set values 1, 4 and 5, the upper and lower limit values can be set independently for each alarm type, and are expressed as "L" and "H."

*2. Set value: 1, Upper- and lower-limit alarm

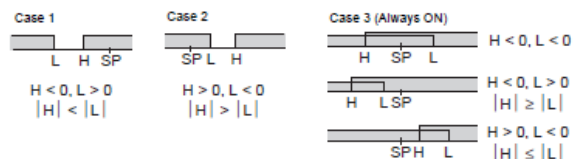

*3. Set value: 4, Upper- and lower-limit range

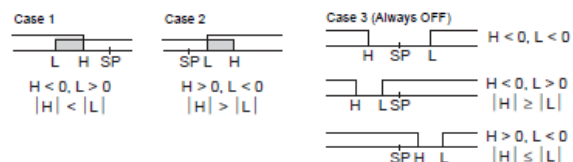

*4. Set value: 5, Upper- and lower-limit with standby sequence
For Upper- and Lower-Limit Alarm Described Above

- Case 1 and 2
Always OFF when the upper-limit and lower-limit hysteresis overlaps.

- Case 3: Always OFF

*5. Set value: 5, Upper- and lower-limit with standby sequence
Always OFF when the upper-limit and lower-limit hysteresis overlaps.

**Recommended replacement
Model E5EC series**

Alarm types







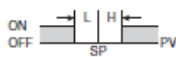
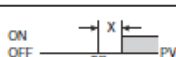
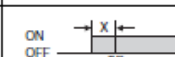
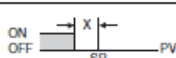

The set values 14 and higher were newly added for the alarm types.

Each alarm can be independently set to one of the following 19 alarm types. The default is 2: Upper limit. (see note.)

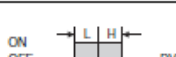
Auxiliary outputs are allocated for alarms. ON delays and OFF delays (0 to 999 s) can also be specified.

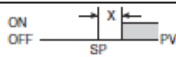
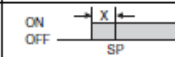
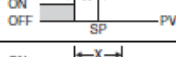
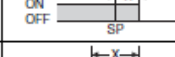
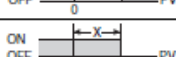
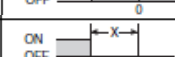
Note: In the default settings for models with HB or HS alarms, alarm 1 is set to a heater alarm (HA) and the Alarm Type 1 parameter is not displayed.

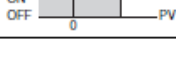
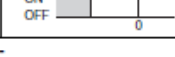
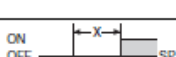
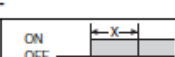
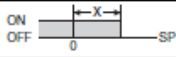
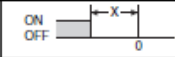
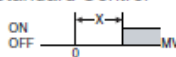
To use alarm 1, set the output assignment to alarm 1.

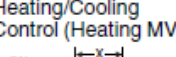
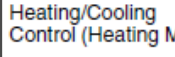
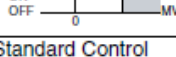
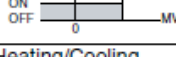
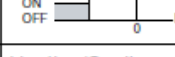
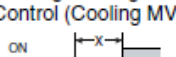
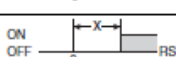
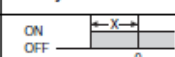
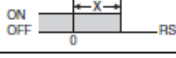
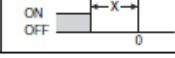
Set value	Alarm type	Alarm output operation		Description of function
		When alarm value X is positive	When alarm value X is negative	
0	Alarm function OFF	Output OFF		No alarm
1	Upper- and lower-limit *1		*2	Set the upward deviation in the set point for the alarm upper limit (H) and the lower deviation in the set point for the alarm lower limit (L). The alarm is ON when the PV is outside this deviation range.
2 (default)	Upper-limit			Set the upward deviation in the set point by setting the alarm value (X). The alarm is ON when the PV is higher than the SP by the deviation or more.
3	Lower-limit			Set the downward deviation in the set point by setting the alarm value (X). The alarm is ON when the PV is lower than the SP by the deviation or more.
4	Upper- and lower-limit range *1		*3	Set the upward deviation in the set point for the alarm upper limit (H) and the lower deviation in the set point for the alarm lower limit (L). The alarm is ON when the PV is inside this deviation range.
5	Upper- and lower-limit with standby sequence *1		*4	A standby sequence is added to the upper- and lower-limit alarm (1). *6
6	Upper-limit with standby sequence			A standby sequence is added to the upper-limit alarm (2). *6
7	Lower-limit with standby sequence			A standby sequence is added to the lower-limit alarm (3). *6
8	Absolute-value upper-limit			The alarm will turn ON if the process value is larger than the alarm value (X) regardless of the set point.
9	Absolute-value lower-limit			The alarm will turn ON if the process value is smaller than the alarm value (X) regardless of the set point.
10	Absolute-value upper-limit with standby sequence			A standby sequence is added to the absolute-value upper-limit alarm (8). *6
11	Absolute-value lower-limit with standby sequence			A standby sequence is added to the absolute-value lower-limit alarm (9). *6
12	LBA (alarm 1 type only)	-		*7
13	PV change rate alarm	-		*8
14	SP absolute-value upper-limit alarm			This alarm type turns ON the alarm when the set point (SP) is higher than the alarm value (X).
15	SP absolute-value lower-limit alarm			This alarm type turns ON the alarm when the set point (SP) is lower than the alarm value (X).
16	MV absolute-value upper-limit alarm *9	Standard Control 	Standard Control 	This alarm type turns ON the alarm when the manipulated variable (MV) is higher than the alarm value (X).
		Heating/Cooling Control (Heating MV) 	Heating/Cooling Control (Heating MV) Always ON	
17	MV absolute-value lower-limit alarm *9	Standard Control 	Standard Control 	This alarm type turns ON the alarm when the manipulated variable (MV) is lower than the alarm value (X).
		Heating/Cooling Control (Cooling MV) 	Heating/Cooling Control (Cooling MV) Always ON	
18	RSP absolute-value upper-limit alarm *10			This alarm type turns ON the alarm when the remote SP (RSP) is higher than the alarm value (X).
19	RSP absolute-value lower-limit alarm *10			This alarm type turns ON the alarm when the remote SP (RSP) is lower than the alarm value (X).

- *1 With set values 1, 4 and 5, the upper and lower limit values can be set independently for each alarm type, and are expressed as "L" and "H."
- *2 Set value: 1, Upper- and lower-limit alarm
 - Case 1

H<0, L>0
|H| < |L|
 - Case 2

H>0, L<0
|H| > |L|
 - Case 3 (Always ON)

H<0, L>0
|H| > |L|
- *3 Set value: 4, Upper- and lower-limit range
 - Case 1

H<0, L>0
|H| < |L|
 - Case 2

H>0, L<0
|H| > |L|
 - Case 3 (Always OFF)

H<0, L>0
|H| > |L|
- *4 Set value: 5, Upper- and lower-limit with standby sequence
 - For Upper- and Lower-Limit Alarm Described Above *2
 - Case 1 and 2
Always OFF when the upper-limit and lower-limit hysteresis overlaps.
 - Case 3: Always OFF
- *5 Set value: 5, Upper- and lower-limit with standby sequence
Always OFF when the upper-limit and lower-limit hysteresis overlaps.
- *6 Refer to the *E5EC Digital Temperature Controllers User's Manual* (Cat. No. H174) for information on the operation of the standby sequence.
- *7 Refer to the *E5EC Digital Temperature Controllers User's Manual* (Cat. No. H174) for information on the loop burnout alarm (LBA).
- *8 Refer to the *E5EC Digital Temperature Controllers User's Manual* (Cat. No. H174) for information on the PV change rate alarm.
- *9 When heating/cooling control is performed, the MV absolute upper limit alarm functions only for the heating operation and the MV absolute lower limit alarm functions only for the cooling operation.
- *10 This value is displayed only when a remote SP input is used. It functions in both Local SP Mode and Remote SP Mode.
Remote SP input is supported only for the E5CC.

[Operation methods]

**Product discontinuation
Model E5EN series**

- Mode key Press this key to change the contents of the display. Press this button for 1 s or longer for reverse scroll.
- Level key Use this key to change levels:
 - Press the key and the key together for at least 3 seconds to switch to protect level.
 - Function key/Auto/Manual key Press this function key to operate the function set with the PF Setting.

- No.1 display Process value or set data symbol
- No.2 display Set point, set data read-out value or changed input value
- No. 3 display MV, Soak Time Remain, and Multi-SP.
- Up and Down keys Use the keys to change the values displayed on the No.2 display. Each press of key increments or advances the values displayed on the No.2 display. Each press of key decrements or returns the values displayed on the No.2 display.

**Recommended replacement
Model E5EC series**

- °C / °F : temperature unit The temperature unit is displayed when the displayed value is a temperature. Either or is displayed according to the set value of the temperature unit.
- Shift key (PF key) The default PF Setting parameter is for shifting the digit. This is a function key. When it is pressed, the function set for the PF Setting parameter will operate.
- Front-panel Setup Tool port This port is used to connect the Controller to a computer to use the Setup Tool.
- Level key Use this key to change levels:

- No.1 display Process value or set data type
- No.2 display Set point, set data read-out value or changed input value
- No. 3 display MV, Soak Time Remain, and Multi-SP.
- Up and Down keys Each press of key increments or advances the values displayed on the No.2 display. Each press of key decrements or returns the values displayed on the No.2 display.
- Mode key Press this key to change the contents of the display. Press this button for 1 s or longer for reverse scroll.
- Press the key and the key together for at least 3 seconds to switch to protect level.

Specifications and prices in this product news are as of the issue date and are subject to change without notice. Only main changes in specifications are described in this document. Please be sure to read the relevant catalogs, datasheets, product specifications, instructions, and manuals for precautions and necessary information when using products.