

# mitsubishi

Type SW0D5C-ACT-E ActiveX Communication Support Tool

---

## Operating Manual



Mitsubishi Programmable Logic Controller

# • SAFETY PRECAUTIONS •

(Always read these instructions before using this equipment.)

Before using this product, please read this manual and the relevant manuals introduced in this manual carefully and pay full attention to safety to handle the product correctly.

The instructions given in this manual are concerned with this product. For the safety instructions of the programmable controller system, please read the CPU module user's manual.

In this manual, the safety instructions are ranked as "DANGER" and "CAUTION".



Indicates that incorrect handling may cause hazardous conditions, resulting in death or severe injury.



Indicates that incorrect handling may cause hazardous conditions, resulting in medium or slight personal injury or physical damage.

Note that the  CAUTION level may lead to a serious consequence according to the circumstances. Always follow the instructions of both levels because they are important to personal safety.

Please save this manual to make it accessible when required and always forward it to the end user.

## [Design Instructions]

### **DANGER**

- When performing data changes or status control from the peripheral device to the running PLC, configure up an interlock circuit outside the PLC system to ensure that the whole system will operate safely.

In addition, predetermine corrective actions for the system so that you can take measures against any communication error caused by a cable connection fault or the like in online operations performed from the peripheral device to the PLC.

### **CAUTION**

- Read the manual carefully before performing the online operations (especially forced output and operating status change) which will be executed with the peripheral device connected to the running CPU module.

Not doing so can damage the machine or cause an accident due to misoperation.

REVISIONS

\* The manual number is given on the bottom left of the back cover.

Print Date	* Manual Number	Revision
Apr., 2000	SH (NA)-080077-A	First edition

Japanese Manual Version SH-080079-A

This manual confers no industrial property rights or any rights of any other kind, nor does it confer any patent licenses. Mitsubishi Electric Corporation cannot be held responsible for any problems involving industrial property rights which may occur as a result of using the contents noted in this manual.

© 2000 MITSUBISHI ELECTRIC CORPORATION

## Operating Instructions

- (1) When using Windows NT 4.0  
When using Windows NT 4.0, ACT may be installed and used only on the administrator's authority.
- (2) About Ethernet communication, computer link communication and CPU COM communication on Windows 95
  - (a) Making Ethernet communication using UDP/IP on Windows 95 of the version older than OSR2 will cause a memory leak. When performing continuous operation on Windows 95, use Windows 95 OSR2 or later.
  - (b) On Windows 95, communication using the COM port, e.g. computer link communication or CPU COM communication, will cause a memory leak. Therefore, do not perform continuous operation.
- (3) About overwrite installation  
When performing overwrite installation, install the software in the folder where it had already been installed.
- (4) Precautions for performing installation and uninstallation on a dual boot machine where two different operating systems are installed in a single IBM-PC/AT compatible personal computer  

On a dual boot machine having Windows NT 4.0 (hereafter referred to as OS1) and Windows 95/98 (hereafter referred to as OS2), note the following points when ACT was installed on OS1 first and ACT was then installed over the same folder on OS2.

  - (a) If ACT is uninstalled first on the OS2 side, uninstallation does not delete the control DLLs and ACT folders, and they remain within the IBM-PC/AT compatible.  
To delete the control DLLs and ACT folders, perform uninstallation also on the OS1 side.
  - (b) If ACT is uninstalled first on the OS1 side, the control DLLs and ACT folders are deleted.  
In this case, ACT may not operate properly or cannot be uninstalled on the OS2 side. Install ACT again on the OS2 side to operate ACT properly or uninstall it on the OS2 side.
- (5) About the number of licenses  
The number of licenses is preset to ACT.  
Installation decreases the number of licenses by 1.  
Conversely, uninstallation increases the number of licenses by 1.  
Therefore, when deleting ACT, always uninstall it.  
Note that the number of licenses will not increase if the folders and files are deleted on Explorer or the like.
- (6) About start menu  
When you have uninstalled ACT, the item may remain in the start menu.  
In that case, restart the IBM-PC/AT compatible personal computer.

- (7) About the resume and other functions of personal computer  
A communications error may occur if communications are made with the PLC CPU after setting the resume function, suspend setting, power-saving function and/or standby mode of the personal computer.  
Therefore, do not set the above functions when making communications with the PLC CPU.
- (8) About transmission speed  
As the transmission speed of the QCPU, you can set 9600bps, 19200bps, 38400bps, 57600bps or 115200bps.  
For the QnACPU of version 9707B or later, you can set the transmission speed of 9600bps, 19200bps or 38400bps.  
For the QnACPU of other versions, you can set 9600bps or 19200bps.  
The transmission speeds of the ACPUs (except A2USHCPU-S1), FXCPU and motion controller CPU are fixed to 9600bps. (The A2USHCPU-S1 may be set to 19200bps.)
- (9) About use of the Q4ARCPU  
(a) When using the Q4ARCPU, you cannot use UDP/IP of Ethernet communication.  
(b) The duplexing function cannot be used.
- (10) Restrictions on use of the FXCPU  
(a) For the index registers (Z, V) of the FXCPU, data cannot be written to 2 or more consecutive points using WriteDeviceBlock(). (Data may be written to only one point.)  
(b) When the FXCPU is used, access to the TN devices (timer present values) or CN devices (counter present values) is not permitted if the device numbers specified are split across 199 or earlier and 200 or later.
- (11) About clock data of the PLC CPU  
(a) For the ACPUs (including the motion controller CPU), clock data setting may be made only when the PLC CPU is in the STOP status.  
For the QCPU (Q mode), (A mode), QnACPU and FXCPU, clock data setting may be made if the PLC CPU is in the RUN status.  
(b) For the A0J2HCPU, A2CCPU and A2CJCPU, setting cannot be made as they do not have the clock function.  
(c) For the ACPUs, setting can be made independently of whether the clock setting special relay "M9028" is ON or OFF. (Note that the special relay "M9028" turns OFF after execution.)  
For the QCPU (Q mode), (A mode) and QnACPU, setting can be made independently of whether the clock setting device "SM1028" is ON or OFF.  
(d) Among the FXCPUs, setting may be made for only the FX1N (clock built-in), FX1S (clock built-in), FX2N (clock built-in), FX2NC (clock built-in), FX2 (when RTC cassette is fitted) and FX2C (when RTC cassette is fitted).  
(e) Note that an error for transfer time will be produced in clock setting.

- (12) About simultaneous use of ACT and GPPW  
When using GPPW and ACT together for the same E71 module to make Ethernet communication, make the following settings.
- (a) Set the protocol of the communication setting wizard screen to "UDP/IP".
  - (b) Set "SW2" of the communications setting switches of the E71 module to OFF (binary).
- (13) About simultaneous access to Ethernet module  
For Ethernet communication in which access to the same module will be made simultaneously from multiple IBM-PC/AT compatibles, make the following settings.
- (a) Set the protocol of the communication setting wizard screen to "UDP/IP".
  - (b) Set "SW2" of the communications setting switches of the Ethernet module to OFF (binary).
- (14) About target existence check starting interval\*1 of Ethernet module  
If close processing (Close) is executed from the IBM-PC/AT compatible, the Ethernet module may not perform close processing (Close).  
One of its causes is the open cable.  
If open processing (Open) is executed from the IBM-PC/AT compatible with the Ethernet module not performing close processing (Close), open processing (Open) from the IBM-PC/AT compatible is not terminated normally until the Ethernet module makes a target existence check and executes close processing (Close).  
If you want to terminate open processing (Open) early from the IBM-PC/AT compatible, shorten the target existence check starting interval setting of the Ethernet module.  
(The target existence check starting interval setting of the Ethernet module defaults to 10 minutes.)  
\*1: It can be set for the E71 of AJ71E71-S3 or later.
- (15) Software version of CC-Link master/local module  
As the CC-Link master/local module used in CC-Link communication or CC-Link G4 communication, use the module of software version "N" or later.  
The module of software version "M" or earlier will not operate properly.
- (16) Software version of CC-Link G4 module  
As the CC-Link G4 module used in CC-Link G4 communication, use the module of software version "D" or later.  
The module of software version "C" or earlier will not operate properly.
- (17) About relaying from the MELSECNET/10 loaded station  
When the module is loaded to the AnNCP or AnACPU, it is recognized as a MELSECNET(II) module.  
When the connected station is the AnNCP or AnACPU, set the relayed network as MELSECNET(II).  
In addition, set the station number to "0" when making access to the control station.

(18) About computer link communication

- (a) If the connected station CPU is the AnUCPU and the computer link module is the UC24 for computer link connection, remote operation will result in an error when access is made to the AnNCPU, AnACPU or QnACPU via the MELSECNET/10.
- (b) On any computer link modules other than the UC24 and C24, remote "PAUSE" operation will result in an error for all connections.
- (c) For the QC24, note that the illegal case of specifying the first I/O number of a nonexisting module and reading/writing U\*\*\G\*\* will not return an error if the software version of the module is "k" or earlier.
- (d) In any connection form (direct coupling, relaying) where the target station of the UC24 or C24 is the QnACPU, an error is returned if clock data read/write is executed.

(19) Precautions for USB communication

Frequently disconnecting/reconnecting the USB cable or resetting or powering ON/OFF the PLC CPU during communications with the PLC CPU may cause a communications error which cannot be recovered.

If it is not recovered, completely disconnect the USB cable once and then reconnect it after 5 or more seconds have elapsed.

(If this error occurs at the initial communication after the above operation, the function will be performed properly in and after the second communications.)

(20) Precautions for ladder logic test communication

When running a user program, make sure that the ladder logic test function (LLT) and GPPW have started.

In addition, do not terminate the ladder logic test function (LLT) and GPPW while the user program is running.

If you do so, you will not be able to terminate the user program normally.

(21) About forced termination of processes during communication

If communication is being made with the same type of control open for multiple processes, forcing one process to be terminated by Task Manager or the like may stop the other processes at the communication function execution area.

(22) About the sample sequence programs

The sample sequence programs attached to ACT assume that only an IBM-PC/AT compatible personal computer and Ethernet modules exist in the network.

Depending on your system configuration and parameter settings, the programs must be modified. Make corrections to make the programs optimum for your system.

Also, use the sample sequence programs on your own responsibility.

## INTRODUCTION

Thank you for choosing Type SW0D5C-ACT ActiveX Communication Support Tool.  
Before using the product, please read this manual carefully to use Type SW0D5C-ACT ActiveX Communication Support Tool to its optimum.

## CONTENTS

SAFETY PRECAUTIONS.....	A- 1
REVISIONS .....	A- 2
Operating Instructions .....	A- 3
CONTENTS.....	A- 7
About Manuals .....	A-10
How to Use This Manual.....	A-11
Abbreviations and Terms in This Manual .....	A-12
Meanings and Definitions of Terms .....	A-14
<b>1 OVERVIEW</b>	<b>1- 1 to 1- 4</b>
1.1 Features .....	1- 1
<b>2 SYSTEM CONFIGURATIONS</b>	<b>2- 1 to 2-12</b>
2.1 System Configuration List.....	2- 1
2.1.1 When using Windows NT Workstation 4.0.....	2- 1
2.1.2 When using Windows 95 .....	2- 2
2.1.3 When using Windows 98 .....	2- 3
2.2 System Configuration for Use of Each Connection Form.....	2- 4
2.2.1 System configurations.....	2- 4
2.2.2 Details of the communication forms .....	2- 5
2.3 Operating Environment.....	2-11
2.4 Usable PLC CPUs .....	2-11
<b>3 OPERATION PROCEDURES</b>	<b>3- 1 to 3- 4</b>
3.1 Selecting the Development Type.....	3- 1
3.2 User Application Creating Procedures .....	3- 2
3.2.1 When using VB.....	3- 2
3.2.2 When using VC++ .....	3- 3
3.3 PLC Monitor Utility Operating Procedure .....	3- 4



<b>4 OPERATIONS COMMON TO UTILITIES</b>	<b>4- 1 to 4- 2</b>
4.1 Starting the Utility .....	4- 1
4.2 Exiting the Utility.....	4- 1
4.3 Confirming the Version .....	4- 2
<b>5 UTILITY OPERATIONS</b>	<b>5- 1 to 5-20</b>
5.1 Communication Setup Utility.....	5- 1
5.1.1 Operations on target setting screen .....	5- 2
5.1.2 Operations on list view screen.....	5- 3
5.1.3 Operations on connection test screen.....	5- 4
5.1.4 Operations on file import screen.....	5- 5
5.1.5 Operations on file export screen.....	5- 6
5.1.6 Operations on communication setting wizard screens .....	5- 7
5.2 PLC Monitor Utility .....	5-11
5.2.1 Operations on transfer setting screen .....	5-11
5.2.2 Operations on device batch screen.....	5-13
5.2.3 Operations on buffer memory screen.....	5-15
5.2.4 Operation on entry device screen.....	5-17
5.2.5 Operations on device write screen .....	5-19
5.2.6 Operations on clock setting screen .....	5-20
<b>6 COMMUNICATION SETTING EXAMPLES OF THE UTILITY SETTING TYPE</b>	<b>6- 1 to 6-62</b>
6.1 Computer Link Communication .....	6- 1
6.1.1 Switch settings of computer link modules .....	6- 1
6.1.2 Accessing procedure.....	6- 6
6.2 Ethernet Communication .....	6-12
6.2.1 Switch settings of Ethernet modules .....	6-12
6.2.2 Accessing procedure.....	6-13
6.3 CPU COM Communication.....	6-28
6.3.1 Accessing procedure.....	6-28
6.4 CPU USB Communication.....	6-32
6.4.1 Accessing procedure.....	6-32
6.5 MELSECNET/10 Communication .....	6-36
6.5.1 Accessing procedure.....	6-36
6.6 CC-Link Communication.....	6-41
6.6.1 Accessing procedure.....	6-41
6.7 CC-Link G4 Communication.....	6-46
6.7.1 Switch settings of CC-Link G4 module.....	6-46
6.7.2 Accessing procedure.....	6-47
6.8 CPU Board Communication .....	6-54
6.8.1 Accessing procedure.....	6-54
6.9 Ladder Logic Test Communication.....	6-60
6.9.1 Accessing procedure.....	6-60

8 ACCESSIBLE DEVICES AND RANGES	8- 1 to 8-28
---------------------------------	--------------

8.1 Precautions for Device Access .....	8- 1
8.2 For Computer Link Communication.....	8- 2
8.2.1 Accessible devices .....	8- 2
8.2.2 Accessible ranges .....	8- 4
8.3 For Ethernet Communication.....	8- 6
8.3.1 Accessible devices .....	8- 6
8.3.2 Accessible ranges .....	8- 8
8.4 For CPU COM Communication .....	8-10
8.4.1 Accessible devices .....	8-10
8.4.2 Accessible ranges .....	8-12
8.5 For CPU USB Communication .....	8-14
8.5.1 Accessible devices .....	8-14
8.5.2 Accessible ranges .....	8-16
8.6 For MELSECNET/10 Communication.....	8-17
8.6.1 Accessible devices .....	8-17
8.6.2 Accessible ranges .....	8-19
8.7 For CC-Link Communication .....	8-20
8.7.1 Accessible devices .....	8-20
8.7.2 Accessible ranges .....	8-22
8.8 For CC-Link G4 Communication .....	8-23
8.8.1 Accessible devices .....	8-23
8.8.2 Accessible ranges .....	8-25
8.9 For CPU Board Communication .....	8-26
8.9.1 Accessible devices .....	8-26
8.9.2 Accessible ranges .....	8-28

APPENDIX	Appendix- 1 to Appendix- 2
----------	----------------------------

Appendix 1 Concept of the Routing Parameters.....	Appendix- 1
---	-------------

## About Manuals

The following lists the manuals for this software package.  
Refer to the following table when ordering manuals.

### Related Manuals

Manual Name	Manual Number (Model Code)
Type SW0D5C-ACT-E ActiveX Communication Support Tool Operating Manual (Startup) Provides procedures for installing and uninstalling SW0D5C-ACT-E and for browsing the operating manual. (Packed with the product)	IB-0800112 (13J982)
Type SW0D5C-ACT-E ActiveX Communication Support Tool Programming Manual Provides the programming procedures, detailed explanations and error codes of the ActiveX controls. (Optionally available)	SH-080078 (13JF62)
Type A70BDE-J71QLP23/A70BDE-J71QLP23GE/A70BDE-J71QBR13/A70BDE-J71QLR23 MELSECNET/10 Interface Board User's Manual(For SW3DNF-MNET10) Describes the features, specifications, part names and setting of the MELSECNET/10 board, and the installation, uninstallation and others of the driver. (Packed with the product)	IB-0800035 (13JL93)
Type A80BDE-J61BT11 CC-Link System Master/Local Interface Board User's Manual (For SW3DNF-CCLINK) Describes the features, specifications, part names and setting of the CC-Link master board, and the installation, uninstallation and others of the driver. (Packed with the product)	IB-0800110 (13JR14)
Type A80BDE-J61BT13 CC-Link Interface Board User's Manual (For SW3DNF-CCLINK) Describes the features, specifications, part names and setting of the CC-Link local board, and the installation, uninstallation and others of the driver. (Packed with the product)	IB-0800036 (13JL94)
Type A80BDE-A2USH-S1 PLC CPU Board User's Manual (For SW0DNF-ANU-B) Describes the features, specifications, part names and setting of the CPU board, and the installation, uninstallation and others of the driver. (Packed with the product)	IB-0800087 (13JR08)

Note: Type SW0D5C-ACT-E ActiveX Communication Support Tool Programming Manual is contained in the CD-ROM together with the software package as a set.

When you want to purchase the manual alone, it is optionally available as the printed matter of the manual number (Model code) in the above table.

## How to Use This Manual

"HOW TO USE THIS MANUAL" is given purpose-by-purpose for use of ACT. Refer to the following outlines and use this manual.

- (1) To know the features (Section 1.1)  
Section 1.1 gives the features.
- (2) To know the system configurations (Sections 2.1, 2.2)  
The system configurations using ACT are provided.
- (3) To know the ACT operating environment and usable PLC CPUs (Sections 2.3, 2.4)  
Section 2.3 gives the operating environment of ACT and Section 2.4 indicates usable PLC CPUs.
- (4) To know the ACT operating procedures (Chapter 3)  
Chapter 3 provides the operation procedures of ACT.
- (5) To know how to operate the utilities (Chapters 4, 5)  
Chapter 4 describes operations common to the utilities, and Chapter 5 explains how to operate the utilities.  
Read these chapters when using the utilities.
- (6) To know the communication setting examples of the utility setting type (Chapter 6)  
Chapter 6 gives the setting example of each communication path using the utility setting type.
- (7) To know the communication setting examples of the program setting type (Chapter 7)  
Chapter 7 provides the setting example of each communication path using the program setting type.
- (8) To know the accessible devices and ranges (Chapter 8)  
Chapter 8 contains the accessible devices and accessible ranges.

## Abbreviations and Terms in This Manual

Unless otherwise specified, the following generic terms and abbreviations are used in this manual to describe Type SW0D5C-ACT-E ActiveX Communication Support Tool.

Generic Term/Abbreviation	Description
ACT	Abbreviation of Type SW0D5C-ACT-E ActiveX Communication Support Tool
Windows NT 4.0	Abbreviation of Microsoft Windows NT Workstation 4.0 (English version)
Windows 95	Abbreviation of Microsoft Windows 95 (English version)
Windows 98	Abbreviation of Microsoft Windows 98 (English version)
Windows	Generic term of Windows 95, Windows 98 and Windows NT Workstation 4.0
VB	Abbreviation of Microsoft Visual Basic 6.0 (English version)
VC++	Abbreviation of Microsoft Visual C++ 6.0 (English version)
IBM-PC/AT compatible	Abbreviation of the IBM PC/AT or its compatible personal computer
GPPW	Abbreviation of Type SW□D5C-GPPW-E/SW□D5F-GPPW-E GPP function software package
Ladder logic test function (LLT)	Abbreviation of Type SW□D5C-LLT-E/SW□D5F-LLT-E ladder logic test tool function software package
MELSECNET/10 board	Abbreviation of Type A70BDE-J71QLP23/A70BDE-J71QLP23GE/A70BDE-J71QBR13/A70BDE-J71QLR23 MELSECNET/10 interface board
CC-Link board	Abbreviation of Type A80BDE-J61BT11 CC-Link system master/local interface board and Type A80BDE-J61BT13 CC-Link interface board
CPU board	Abbreviation of Type A80BDE-A2USH-S1 PLC CPU board
AnNCPU	Generic term of the A0J2HCPU, A1SCPU, A1SCPU-S1, A1SCPUC24-R2, A1SHCPU, A1SJCPU, A1SJHCPU, A1NCPU, A2CCPU, A2CCPUC24, A2CCPUC24-PRF, A2CJCPU, A2NCPU, A2NCPU-S1, A2SCPU, A2SCPU-S1, A2SHCPU, A2SHCPU-S1, A3NCPU and A1FXCPU
AnACPU	Generic term of the A2ACPU, A2ACPU-S1, A2ACPUP21/R21, A2ACPUP21-S1, A3ACPU and A3ACPUP21/R21
AnUCPU	Generic term of the A2UCPU, A2UCPU-S1, A2USCPU, A2USCPU-S1, A2ASCPU, A2ASCPU-S1, A2ASCPU-S30, A2USHCPU-S1, A3UCPU and A4UCPU
QnACPU	Generic term of the Q2ACPU, Q2ACPU-S1, Q2ASCPU, Q2ASCPU-S1, Q2ASHCPU, Q2ASHCPU-S1, Q3ACPU, Q4ACPU and Q4ARCPU
ACPU	Generic term of the AnNCPU, AnACPU and AnUCPU
QCPU (A mode)	Generic term of the Q02CPU-A, Q02HCPU-A and Q06HCPU-A
QCPU (Q mode)	Generic term of the Q02CPU, Q02HCPU, Q06HCPU, Q12HCPU and Q25HCPU
QCPU	Generic term of the QCPU (Q mode) and QCPU (A mode)
FXCPU	Generic term of the FX0, FX0s, FX0N, FX1, FX1N, FX1s, FX2, FX2c, FX2N and FX2NC series
Motion controller CPU	Generic term of the A171SHCPU, A172SHCPU, A173UHCPU, A173UHCPU-S1, A273UHCPU and A273UHCPU-S3
PLC CPU	Generic term of the QCPU, QnACPU, ACPU, FXCPU and motion controller CPU
C24	Generic term of the A1SCPUC24-R2, A1SJ71C24-PRF, A1SJ71C24-R2, A1SJ71C24-R4, A2CCPUC24, A2CCPUC24-PRF, AJ71C24-S6 and AJ71C24-S8
UC24	Generic term of the AJ71UC24, A1SJ71UC24-R2, A1SJ71UC24-R4 and A1SJ71UC24-PRF
QC24	Generic term of the AJ71QC24, AJ71QC24-R2, AJ71QC24-R4, A1SJ71QC24-R2 and A1SJ71QC24-R2
QC24N	Generic term of the AJ71QC24N, AJ71QC24N-R2, AJ71QC24N-R4, A1SJ71QC24N and A1SJ71QC24N-R2
QC24(N)	Generic term of the QC24 and QC24N
Q series-compatible C24	Generic term of the QJ71C24 and QJ71C24-R2

Generic Term/Abbreviation	Description
Computer link module	Generic term of the C24, UC24, QC24(N) and Q series-compatible C24
E71	Generic term of the AJ71E71, AJ71E71-S3, A1SJ71E71-B2, A1SJ71E71-B5, A1SJ71E71-B2-S3 and A1SJ71E71-B5-S3
QE71	Generic term of the AJ71QE71, AJ71QE71-B5, A1SJ71QE71-B2 and A1SJ71QE71-B5
Q series-compatible E71	Generic term of the QJ71E71 and QJ71E71-B2
Ethernet module	Generic term of the E71, QE71 and Q series-compatible E71
CC-Link G4 module	Abbreviation of Type AJ65BT-G4 GPP function peripheral connection module
Computer link communication	Abbreviation of communication made with the PLC CPU using the computer link module
Ethernet communication	Abbreviation of communication made with the PLC CPU using the Ethernet module
CPU COM communication	Abbreviation of communication made by connecting the IBM-PC/AT compatible to the RS-232C or RS-422 connector of the PLC CPU
CPU USB communication	Abbreviation of communication made by connecting the IBM-PC/AT compatible to the USB connector of the QCPU (Q mode)
MELSECNET/10 communication	Abbreviation of communication made with the PLC CPU using the MELSECNET/10 board
CC-Link communication	Abbreviation of communication made with the PLC CPU using the CC-Link board
CC-Link G4 communication	Abbreviation of communication made with the PLC CPU using the CC-Link G4 module
CPU board communication	Abbreviation of communication made with the PLC CPU using the CPU board
Ladder logic test communication	Abbreviation of communication made with the ladder logic test function (LLT)
Utility setting type	Abbreviation of user program creation using the communication settings utility
Program setting type	Abbreviation of user program creation without using the communication settings utility
ACT controls	Generic term of the ActiveX controls offered by ACT

Microsoft Windows, Microsoft Windows NT, Microsoft Visual Basic and Microsoft Visual C++ are either trademarks or registered trademarks of Microsoft Corporation in the United States and/or other countries. Ethernet is the registered trademark of Xerox Corporation. Other company and product names herein may be either trademarks or registered trademarks of their respective owners.

## Meanings and Definitions of Terms

The terms used in this manual have the following meanings and definitions.

### (1) Logical station number

The connection target information necessary to open the communication line is combined into one data using the communication setup utility, and that data is provided with a logical number.

This number may be used with the utility setting type only.

(Example) For CPU COM communication

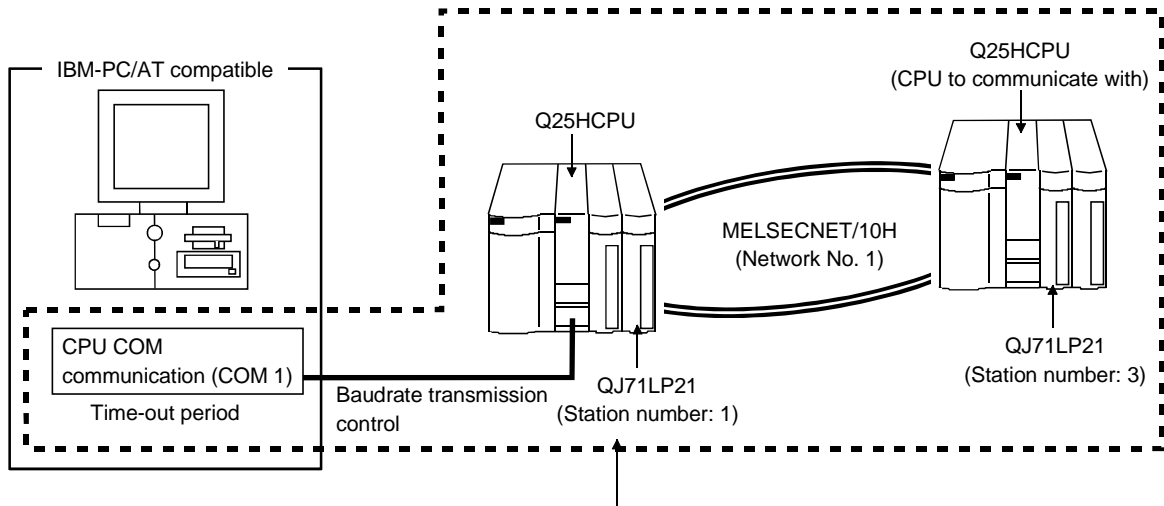

Target information up to CPU to communicate with is combined into one data, to which logical station number is assigned.

### (2) Utility setting type

The communication setup utility (logical station number) is used to create a user program.

In the user program, the communication line can be connected easily by simply specifying the logical station number set on the communication setting wizard.

### (3) Program setting type

A user program is created without using the communication setup utility.

Make ACT control settings for the corresponding communication in the user program or on the property page of VB or VC++.

The properties necessary to be set depend on the ACT control.

1 OVERVIEW

ACT is a tool designed to implement communication from an IBM-PC/AT compatible personal computer to the PLC without any knowledge of communication protocols and modules.

Use of common functions has made it extremely easy to develop serial communication and Ethernet communication programs which had been troublesome and complex.

1.1 Features

ACT has the following features.

(1) Support of a wide range of communication paths for PLC

A wide range of communication paths to the PLC are supported to enable the user to configure up a system as desired.

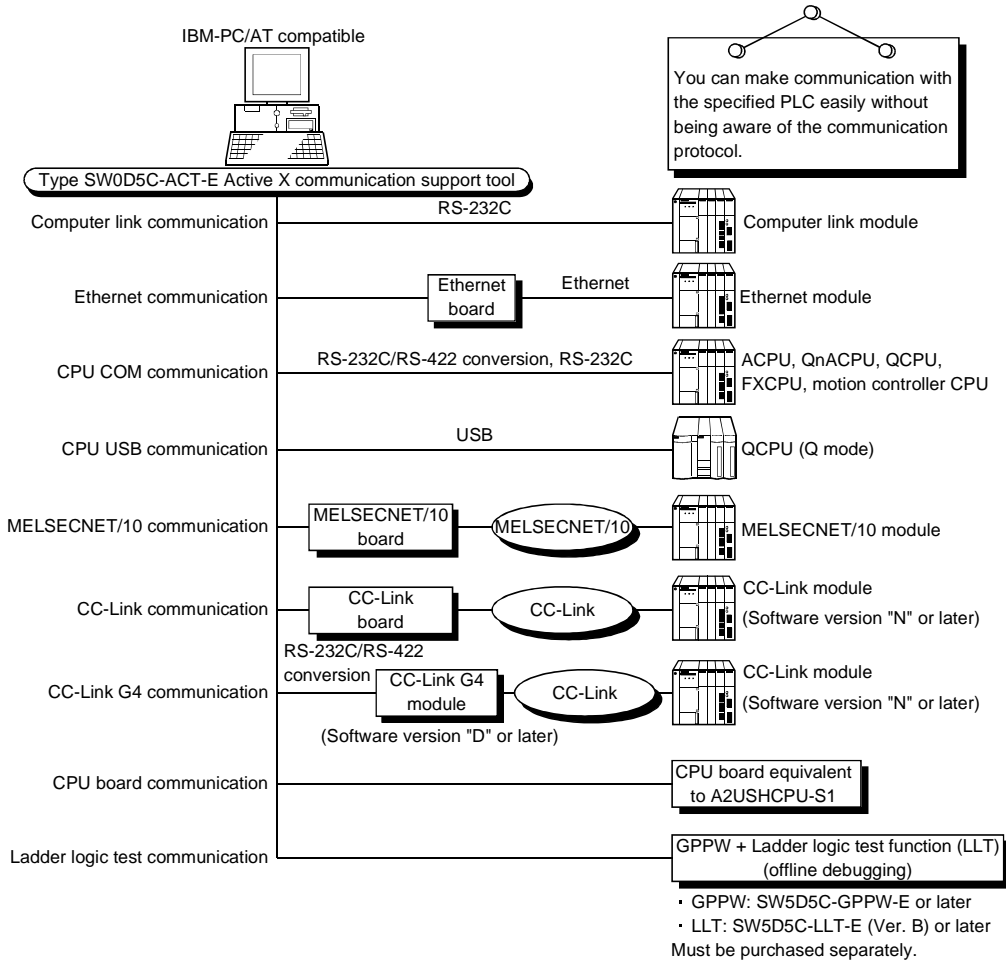



- (2) **Substantial improvement in user's development efficiency**  
 ACT comes with the wizard type communication setup utility.  
 By simply making interactive settings on the screen, the user can achieve communication settings to access the PLC CPU to communicate with.  
 Once the communication settings have been made, access can be made by merely specifying the logical station number of the PLC stored on the communication setup utility.

- (3) **Save and read of communication settings**  
 ACT has the functions to save and read the communication settings made on the communication setup utility.

You can move the set data easily from the IBM-PC/AT compatible used for development to the actually used IBM-PC/AT compatible.

Note: ACT must have been installed in both the IBM-PC/AT compatible used for development and the actually used IBM-PC/AT compatible.

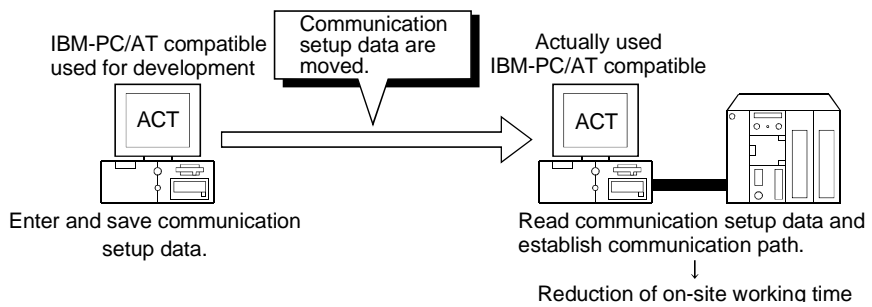

- (4) **Device monitor function**  
 Utilizing the PLC monitor utility enables you to monitor the status of the specified device and change its data.

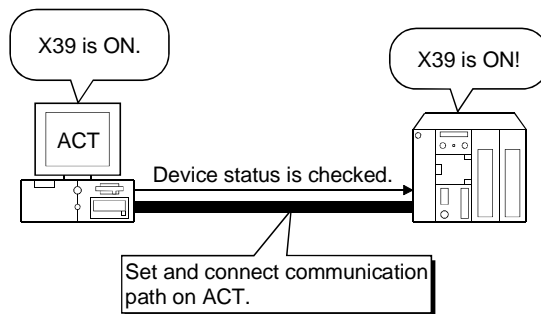

- (5) **Access to buffer memory of special function module**  
 Access can be made to not only the devices of the PLC CPU but also the buffer memory of a special function module.

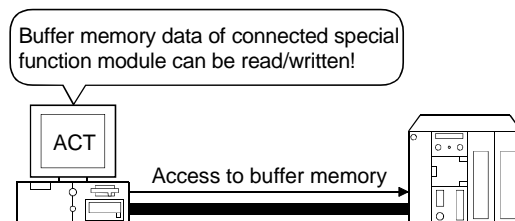

(6) Read/write of PLC CPU clock data

You can read and write the clock data of the PLC CPU connected to the IBM-PC/AT compatible.

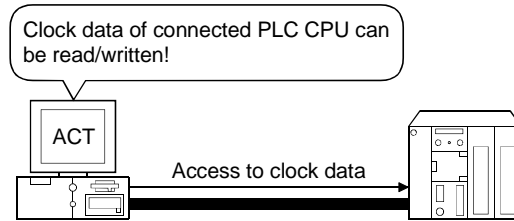

(7) Multithread communication

Access to the same communication path can be made from multiple threads at the same time.

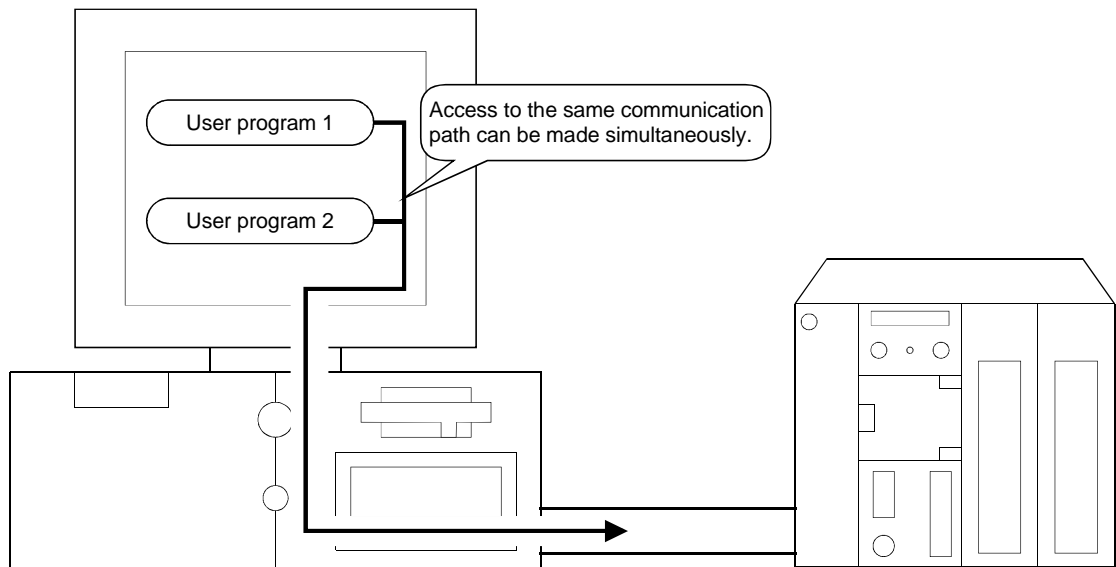

(8) Ladder logic test function (LLT) for offline debugging

By using GPPW and ladder logic test function (LLT), you can perform debugging on a single IBM-PC/AT compatible without connecting the PLC.

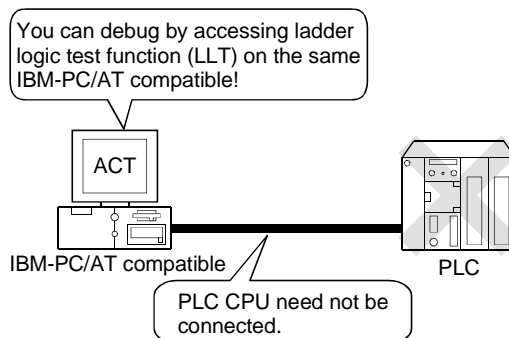

**POINT**

GPPW and ladder logic test function (LLT) are separately required to use the ladder logic test function (LLT).



## 2 SYSTEM CONFIGURATIONS

This chapter describes the system configurations, operating environment and usable CPUs of ACT.

### 2.1 System Configuration List

This section lists the systems that may be configured for each operating system.

#### 2.1.1 When using Windows NT Workstation 4.0

The following table lists the systems that may be configured for use of Windows NT Workstation 4.0.

Item	Description
Computer link communication	○
Ethernet communication	○
CPU COM communication	○
CPU USB communication	× *1
MELSECNET/10 communication	○
Usable board	MELSECNET/10 board
Usable driver	SW2DNF-MNET10, SW3DNF-MNET10
CC-Link communication	○
Usable board	CC-Link board
Usable driver	SW2DNF-CCLINK, SW3DNF-CCLINK
CC-Link G4 communication	○
CPU board communication	○
Usable board	CPU board
Usable driver	SW0DNF-ANU-B
Ladder logic test communication	○

○: Configurable ×: Not configurable

\*1: Does not support the used OS.

POINT
Use GPPW and LLT of the following version or later when making ladder logic test communication.
• GPPW: SW5D5C-GPPW-E
• LLT: SW5D5C-LLT-E (version B or later)

## 2.1.2 When using Windows 95

The following table lists the systems that may be configured for use of Windows 95.

Item	Description
Computer link communication	○
Ethernet communication	○
CPU COM communication	○
CPU USB communication	× *1
MELSECNET/10 communication	○
Usable board	MELSECNET/10 board
Usable driver	SW2DNF-MNET10, SW3DNF-MNET10
CC-Link communication	○
Usable board	CC-Link board
Usable driver	SW2DNF-CCLINK, SW3DNF-CCLINK
CC-Link G4 communication	○
CPU board communication	× *2
Ladder logic test communication	○

○: Configurable ×: Not configurable

\*1: Does not support the used OS.

\*2: The driver is incompatible.

POINT
<p>(1) On Windows 95, a memory leak will occur if any of the following communications is made using the COM port. Therefore, do not perform continuous operation.</p> <ul style="list-style-type: none"> <li>• Computer link communication</li> <li>• CPU COM communication</li> <li>• CC-Link G4 communication</li> </ul> <p>(2) Use GPPW and LLT of the following version or later when making ladder logic test communication.</p> <ul style="list-style-type: none"> <li>• GPPW: SW5D5C-GPPW-E</li> <li>• LLT: SW5D5C-LLT-E (version B or later)</li> </ul>

## 2.1.3 When using Windows 98

The following table lists the systems that may be configured for use of Windows 98.

Item	Description
Computer link communication	○
Ethernet communication	○
CPU COM communication	○
CPU USB communication	○
MELSECNET/10 communication	○
Usable board	MELSECNET/10 board
Usable driver	SW2DNF-MNET10, SW3DNF-MNET10
CC-Link communication	○
Usable board	CC-Link board
Usable driver	SW2DNF-CCLINK, SW3DNF-CCLINK
CC-Link G4 communication	○
CPU board communication	× *2
Ladder logic test communication	○

○: Configurable ×: Not configurable

\*1: Does not support the used OS.

\*2: The driver is incompatible.

**POINT**

Use GPPW and LLT of the following version or later when making ladder logic test communication.

- GPPW: SW5D5C-GPPW-E
- LLT: SW5D5C-LLT-E (version B or later)

2.2 System Configuration for Use of Each Connection Form

This section provides the system configurations for use of ACT on a communication form basis.

2.2.1 System configurations

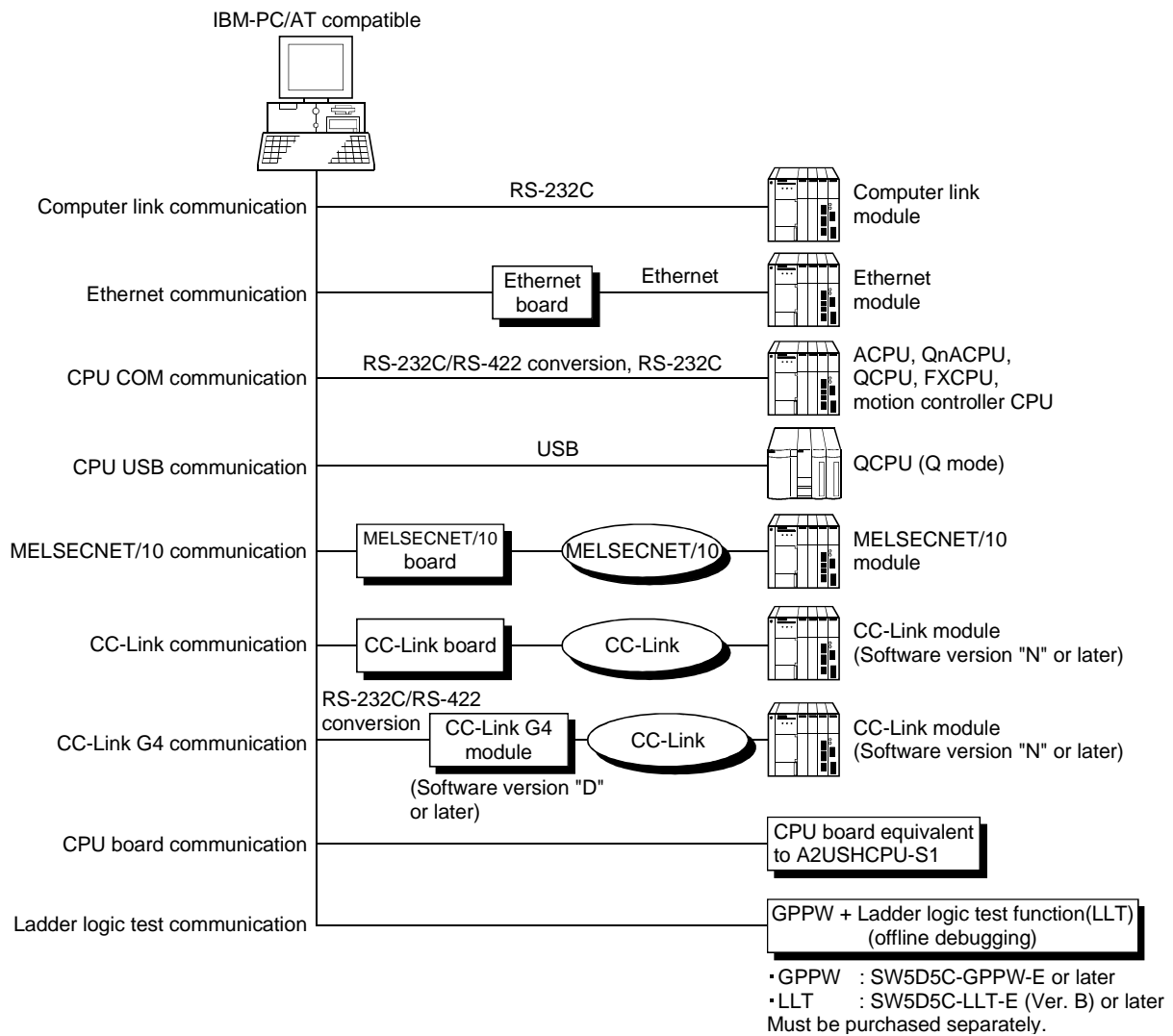

2.2.2 Details of the communication forms

The table at top right of each communication format explanation indicates whether the communication format can be made up when the OSs are used.

Win NT	Win 95	Win 98
○	×	×

○: Configurable ×: Not configurable

(1) Computer link communication

Win NT	Win 95	Win 98
○	○	○

For the way to make connection to the computer link module, read the manual of your computer link module.

(a) Precaution

Computer link communication made on Windows 95 will cause a memory leak. Therefore do not perform continuous operation.

(b) Usable modules

1) Any of the following computer link modules may be used to access the PLC ACPU.

	Usable Modules
C24	A1SCPUC24-R2*1, A1SJ71C24-PRF*2, A1SJ71C24-R2*2, A1SJ71C24-R4*2, A2CCPUC24*4, A2CCPUC24-PRF*3, AJ71C24-S6, AJ71C24-S8
UC24	AJ71UC24, A1SJ71UC24-R2, A1SJ71UC24-R4, A1SJ71UC24-PRF
QC24(N)	AJ71QC24, AJ71QC24-R2, AJ71QC24-R4, A1SJ71QC24, A1SJ71QC24-R2, AJ71QC24N, AJ71QC24N-R2, AJ71QC24N-R4, A1SJ71QC24N, A1SJ71QC24N-R2
Q series-compatible C24	QJ71C24, QJ71C24-R2

\*1: Handled as equivalent to the UC24.

\*2: Modules of software version "M" or later are handled as equivalent to the UC24.

\*3: Modules of software version "K" or later are handled as equivalent to the UC24.



2) About connection of usable modules

When a computer link module is used to make access from the IBM-PC/AT compatible to the PLC CPU, note that three are restrictions on the modules connectable directly to the IBM-PC/AT compatible.

If the module cannot be connected directly to the IBM-PC/AT compatible, it may be used as the "n"th module of multidropping.

Type	Interface	1:1 Connection	Multidropping	
			First module	"n"th module
A2CCPUC24	RS-232C	○	○	×
	RS-422	×	×	×
	RS-422/485	×	×	○
A2CCPUC24-PRF	RS-232C	○	○	×
	RS-422	×	×	×
	RS-422/485	×	×	○
AJ71C24-S6	RS-232C	○	○	×
	RS-422	×	×	○
AJ71C24-S8	RS-232C	○	○	×
	RS-422	×	×	○
A1SCPUC24-R2	RS-232C	○	○	×
A1SJ71C24-PRF	RS-232C	○	○	×
A1SJ71C24-R2	RS-232C	○	○	×
A1SJ71C24-R4	RS-422/485	×	×	○
AJ71UC24	RS-232C	○	○	×
	RS-422/485	×	×	○
A1SJ71UC24-R2	RS-232C	○	○	×
A1SJ71UC24-R4	RS-422/485	×	×	○
A1SJ71UC24-PRF	RS-232C	○	○	×
AJ71QC24	RS-232C	○	○	×
	RS-422/485	×	×	○
AJ71QC24-R2	RS-232C	○	×	×
	RS-232C	×	×	×
AJ71QC24-R4	RS-422	×	×	×
	RS-422/485	×	×	○
A1SJ71QC24	RS-232C	○	○	×
	RS-422/485	×	×	○
A1SJ71QC24-R2	RS-232C	○	×	×
	RS-232C	×	×	×
AJ71QC24N	RS-232C	○	○	×
	RS-422/485	×	×	○
AJ71QC24N-R2	RS-232C	○	×	×
	RS-232C	×	×	×
AJ71QC24N-R4	RS-422	×	×	×
	RS-422/485	×	×	○
A1SJ71QC24N	RS-232C	○	○	×
	RS-422/485	×	×	○
A1SJ71QC24N-R2	RS-232C	○	×	×
	RS-232C	×	×	×
QJ71C24	RS-232	○	○	×
	RS-422/485	×	×	○
QJ71C24-R2	RS-232	○	×	×
	RS-232	×	×	×

(c) Switch settings of the computer link module

For the switch settings for use of ACT, refer to "Section 6.1.1 Switch settings of computer link modules".

(d) Cable for connection

For the connection cable, refer to the manual of your computer link module.

(2) Ethernet communication

Win NT	Win 95	Win 98
○	○	○

For the way to make connection to the Ethernet module, read the manual of your Ethernet module.

(a) Precaution

The accessible range for Ethernet communication is the same segment only. Access cannot be made beyond the router and gateway.

(b) Usable modules

Any of the following Ethernet modules may be used to access the PLC CPU.

	Usable Modules
E71 *1	AJ71E71, AJ71E71-S3, A1SJ71E71-B2, A1SJ71E71-B5, A1SJ71E71B2-S3, A1SJ71E71B5-S3
QE71 *2	AJ71QE71, AJ71QE71-B5, A1SJ71QE71-B2, A1SJ71QE71-B5
Q series-compatible C24	QJ71E71, QJ71E71-B2

\*1: Accessible as equivalent to the AnACPU when fitted to the AnUCPU.

\*2: An error will occur if monitoring via QnA Ethernet and monitoring via other communication path are executed for the same CPU simultaneously.

(c) Switch settings of the Ethernet module

For the switch settings for use of ACT, refer to "Section 6.2.1 Switch settings of Ethernet modules".

(3) CPU COM communication

Win NT	Win 95	Win 98
○	○	○

(a) Precaution

CPU COM communication made on Windows 95 will cause a memory leak. Therefore do not perform continuous operation.

(b) Cables for connection



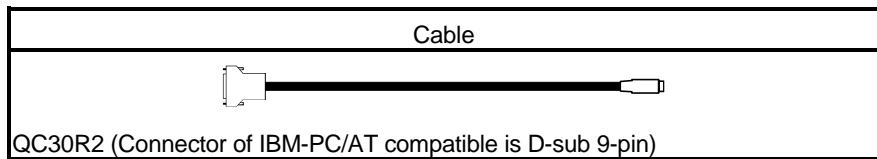

1) Cable for connection of QCPU

The following cable is needed to make communications between the IBM-PC/AT compatible and QCPU.



2) Cables for connection of ACPU, QnACPU or FXCPU

The following cables are needed to make communications between the IBM-PC/AT compatible and ACPU, QnACPU or FXCPU.

IBM-PC/AT Compatible Side (RS-232C Cable)	RS-232C/RS422 Converter	PLC Side (RS-422 Cable)
 F2-232CAB-1*1 (When connector of IBM-PC/AT compatible is D-sub 9-pin)	 FX-232AW(C)	<p>For ACPU, QnACPU or FX1/FX2/FX2cCPU</p> <div style="text-align: center;">                       FX-422CAB (0.3m/0.98feet)                      FX-422CAB-150 (1.5m/4.92feet)                 </div> <hr/> <p>For FX0/FX0s/FX0N/FX1N/FX1S/FX2N/FX2NcCPU</p> <div style="text-align: center;">                       FX-422CAB0 (1.5m/4.92feet)                 </div>

\*1: How to identify compatible product of F2-232CAB-1 cable  
 Check the indication on the type label attached to the cable.

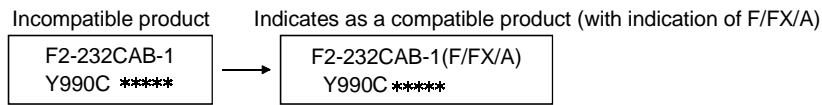

3) Cables for connection of motion controller CPU

For communications between the IBM-PC/AT compatible and motion controller CPU, use the cables as indicated in 2).

(4) CPU USB communication

Win NT	Win 95	Win 98
×	×	○

CPU USB communication can be made only when the QCPU (Q mode) is used.

(a) About the USB cable (QCPU (Q mode) compatible)

- 1) Usable when Windows 98 and USB driver have been installed.
- 2) Unusable with Windows 95 or Windows NT Workstation 4.0.
- 3) When the USB cable is used, only one PLC CPU may be connected.
- 4) Use the USB cable which conforms to the USB Standard Rev. 1.1.
- 5) Refer to "Operating Instructions" for the precautions for and restrictions on use of the USB cable to make communications.

(5) MELSECNET/10 communication

Win NT	Win 95	Win 98
○	○	○

(a) Precautions

- 1) The communication driver used must be SW2DNF-MNET10/SW3DNF-MNET10.  
 Any other communication driver cannot be used.
- 2) To access the QCPU (Q mode), use SW3DNF-MNET10.  
 Using SW2DNF-MNET10 allows access only to the ACPU, QnACPU or QCPU (A mode).

(6) CC-Link communication

Win NT	Win 95	Win 98
○	○	○

(a) Precautions

- 1) The communication driver used must be SW2DNF-CCLINK or SW3DNF-CCLINK.  
 Any other communication driver cannot be used.
- 2) To access the QCPU (Q mode), use the communication drive of SW3DNF-CCLINK and the CC-Link card of software version "W" or later.  
 Using SW2DNF-CCLINK and the CC-Link card of software version "V" or earlier allows access only to the ACPU, QnACPU or QCPU (A mode).
- 3) The CC-Link master station module used should be of software version "N" or later.

(7) CC-Link G4 communication

Win NT	Win 95	Win 98
○	○	○

(a) Precautions

- 1) Computer link communication made on Windows 95 will cause a memory leak. Therefore do not perform continuous operation.
- 2) The CC-Link G4 module used should be of software version "D" or later.
- 3) The CC-Link master station module used should be of software version "N" or later.

(b) Switch settings of the CC-Link G4 module

For the switch settings for use of ACT, refer to "Section 6.7.1 Switch settings of CC-Link G4 module".

(c) About cables

Communications between the IBM-PC/AT compatible and CC-Link G4 module require the RS-232C/RS-422 conversion cables as used in CPU COM communication.

For more information, refer to "(3) 2) Cables for connection of ACPU, QnACPU or FXCPU".

(8) CPU board communication

Win NT	Win 95	Win 98
○	×	×

(a) Precautions

- 1) Use the SW0DNF-ANU-B communication driver.
- 2) Access to the QCPU (Q mode) and FXCPU cannot be made.

(9) Ladder logic test communication

Win NT	Win 95	Win 98
○	○	○

When making ladder logic test communication, use GPPW and logic test function (LLT) of the following versions or later.

- GPPW : SW5D5C-GPPW-E
- LLT : SW5D5C-LLT-E (version B or later)

<b>POINT</b>	GPPW and logic test function (LLT) must be purchased separately.
--------------	--

## 2.3 Operating Environment

The operating environment of ACT is indicated below.

Item	Contents
IBM-PC/AT compatible personal computer	Pentium 133MHz or faster based personal computers that are compatible with Windows operating system *1
Operating system (OS)	Windows 95/Windows 98 or Windows NT Workstation 4.0 (English version) *2
Required memory	32MB or more
Required hard disk space	30MB or more
Disk drive	3.5inch (1.44MB) floppy disk drive required CD-ROM drive (if using CD-ROM media)
Monitor	Resolution 800×600 pixels or higher
Programming language *3	Visual Basic 6.0 (English version), Visual C++ 6.0 (English version)

\*1: You cannot use the multiprocessor-compatible personal computer since its driver is incompatible.

\*2: Service Pack 3 or higher is required for use of Windows NT Workstation 4.0.

\*3: The user programs created in the English environment are usable only in the English environment.

## 2.4 Usable PLC CPUs

The usable PLC CPUs are given below.

	PLC CPU Types
ACPU	A0J2HCPU, A1SCPU, A1SCPU-S1, A1SCPUC24-R2, A1SHCPU, A1SJCPU, A1SJHCPU, A1NCP, A2CCPU, A2CCPUC24, A2CCPUC24-PRF, A2CJCPU, A2NCP, A2NCP-S1, A2SCPU, A2SCPU-S1, A2SHCPU, A2SHCPU-S1, A3NCP, A1FXCPU, A2ACPU, A2ACPU-S1, A2ACPUP21/R21, A2ACPUP21/R21-S1, A3ACPU, A3ACPUP21/R21, A2UCPU, A2UCPU-S1, A2USCPU, A2USCPU-S1, A2ASCPU, A2ASCPU-S1, A2ASCPU-S30, A2USHCPU-S1, A3UCPU, A4UCPU
QnACPU	Q2ACPU, Q2ACPU-S1, Q2ASCPU, Q2ASCPU-S1, Q2ASHCPU, Q2ASHCPU-S1, Q3ACPU, Q4ACPU, Q4ARCPU
QCPU (A mode)	Q02CPU-A, Q02HCPU-A, Q06HCPU-A
QCPU (Q mode)	Q02CPU, Q02HCPU, Q06HCPU, Q12HCPU, Q25HCPU
FXCPU	FX0, FX0S, FX0N, FX1, FX1N, FX1S, FX2, FX2c, FX2N, FX2NC series
Motion controller CPU	A171SHCPU, A172SHCPU, A173UHCPU, A173UHCPU-S1, A273UHCPU, A273UHCPU-S3



## 3 OPERATION PROCEDURES

This chapter explains the selection of the ACT development type and the procedures for creating user applications.

### 3.1 Selecting the Development Type

When using ACT to create user applications, choose the utility setting type or program setting type before creating a user application.

The utility setting type and program setting type will be described.

#### (1) Utility setting type

Make communication settings using the communication setting wizard.

Using the communication setup utility enables you to create a user program without being aware of the complicated parameters of any communication.

In the user program, the communication line can be connected by simply setting the logical station number set on the communication setting wizard to the ACT control property or into a user program.

#### (2) Program setting type

A user program is created without using the communication setup utility.

Make ACT control settings for the corresponding communication in the user program or on the property page of VB or VC++.

The properties necessary to be set depend on the ACT control.

#### (3) Comparison

The following table compares the utility setting type and program setting type.

Setting Type Item	Utility Setting Type	Program Setting Type
Feature	Communication settings can be made easily using the communication setting wizard. In program creation, communication can be made by merely making the setting (logical station number) on the communication setting wizard. (The number of development processes can be reduced.)	All communication settings can be made in the user program. Communication settings can be changed flexibly in the user program.
Used ACT control	ActEasyIF	ACT control for corresponding communication
Whether communication setup utility is used or not	Used.	Not used.
How to connect PLC monitor utility	Choose the logical station number.	Change the settings every time you make connection. (Use the wizard)



3.2 User Application Creating Procedures

3.2.1 When using VB

The following creation procedures assumes use of VB.

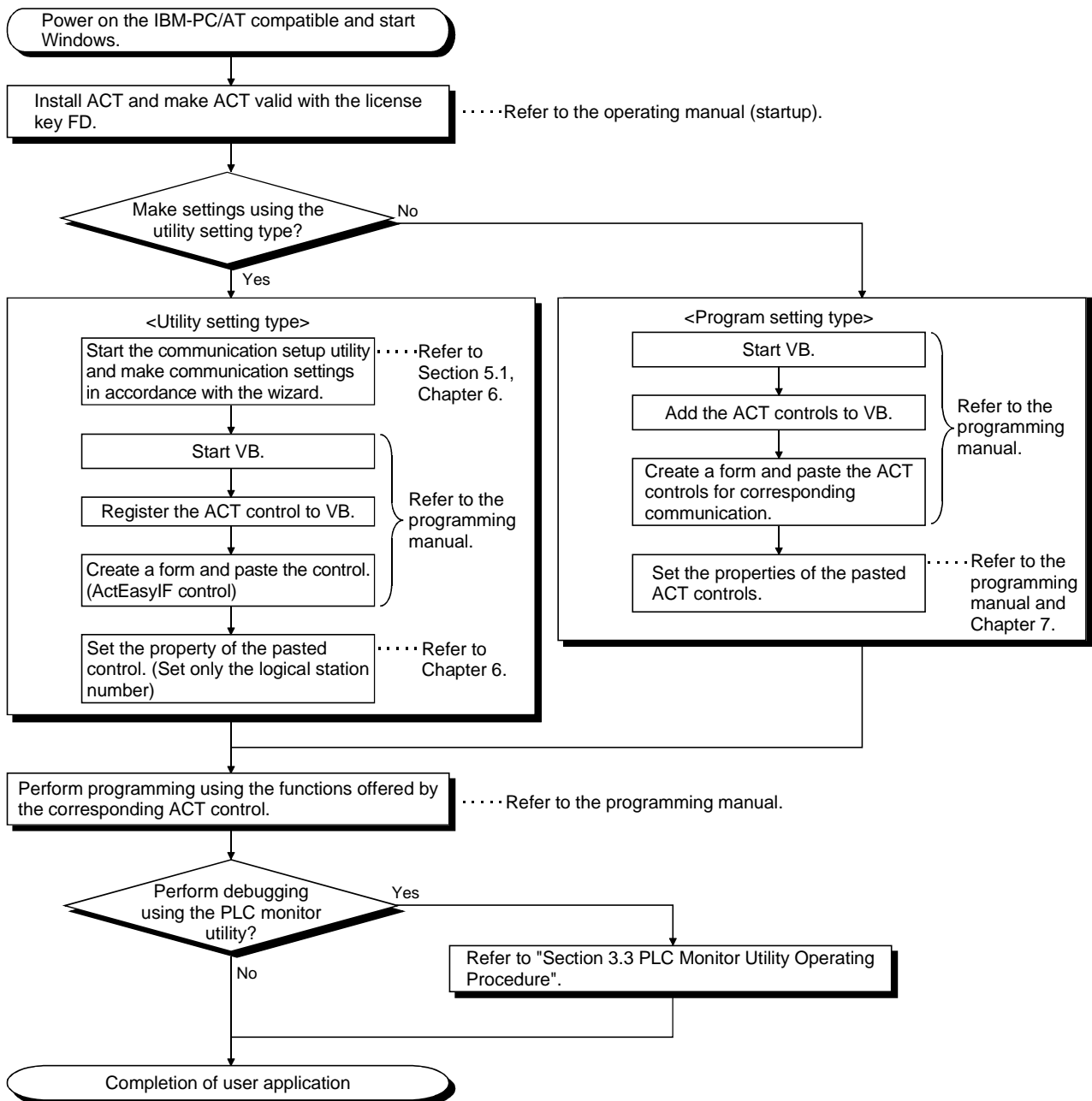

3.2.2 When using VC++

The following creation procedures assumes use of VC++.

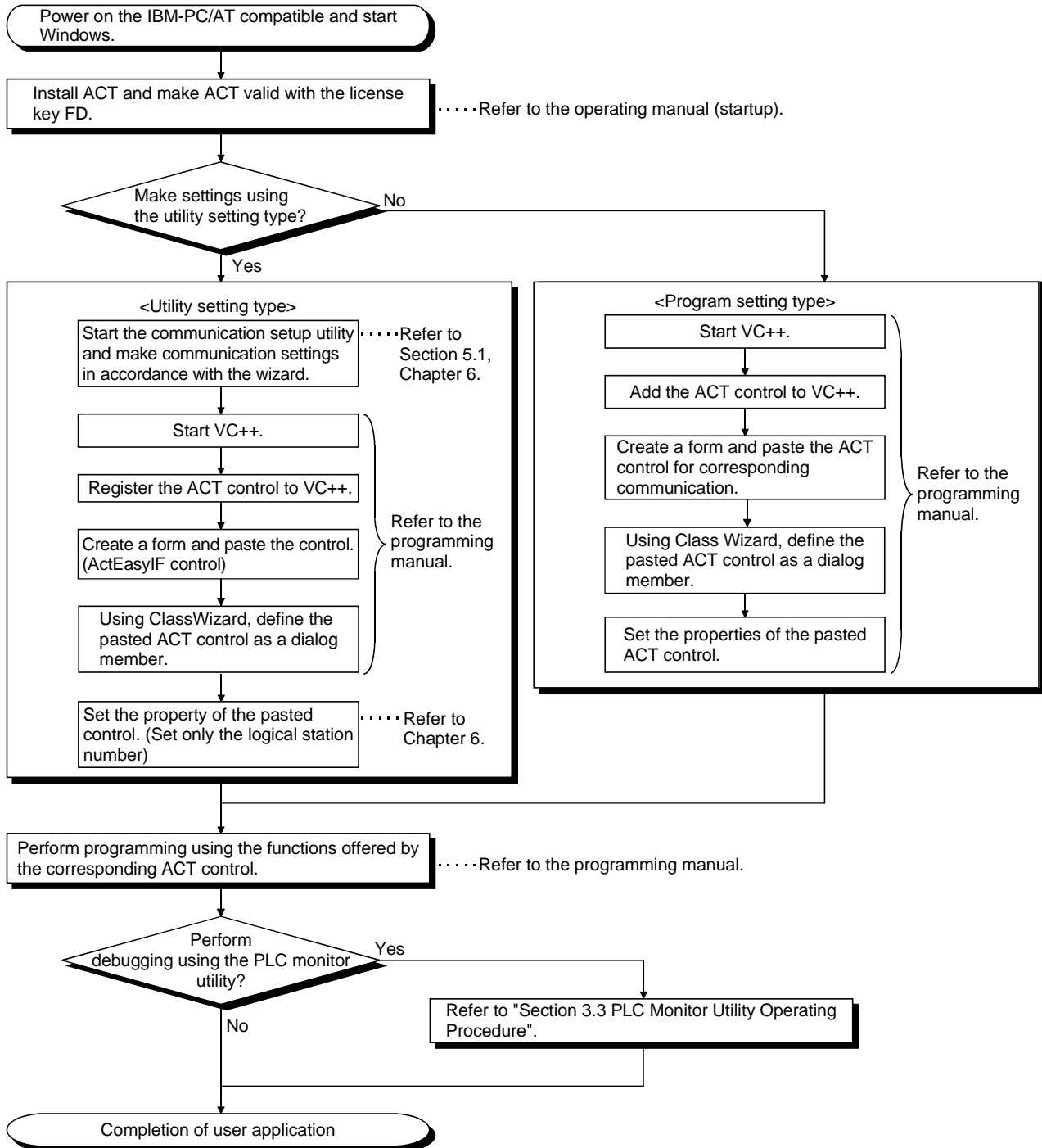

3.3 PLC Monitor Utility Operating Procedure

The following is the PLC monitor utility operating procedure.

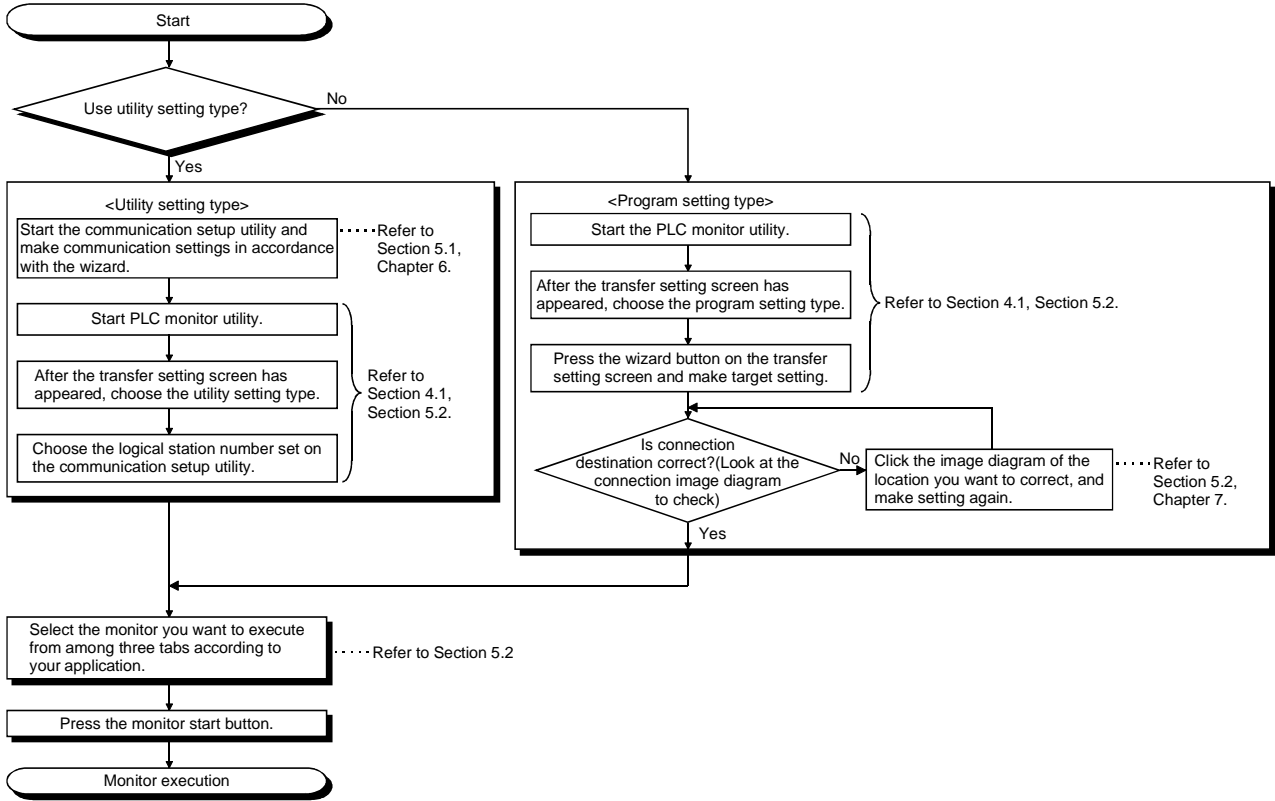

## 4 OPERATIONS COMMON TO UTILITIES

This chapter explains the operations common to the utilities.

### 4.1 Starting the Utility

Each utility can be started by clicking the corresponding icon in the [Start]-[Melsec Application]-[ActiveX Communication Support Tool] menu.

For the registered icons, refer to the operating manual (startup).

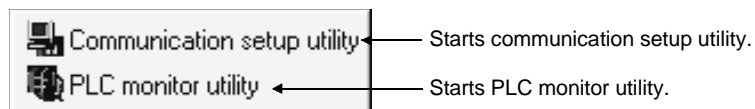

### 4.2 Exiting the Utility

To exit each utility, click the **Exit** button at bottom right of the screen. As the dialog box appears, click the **Yes** button to exit the utility.

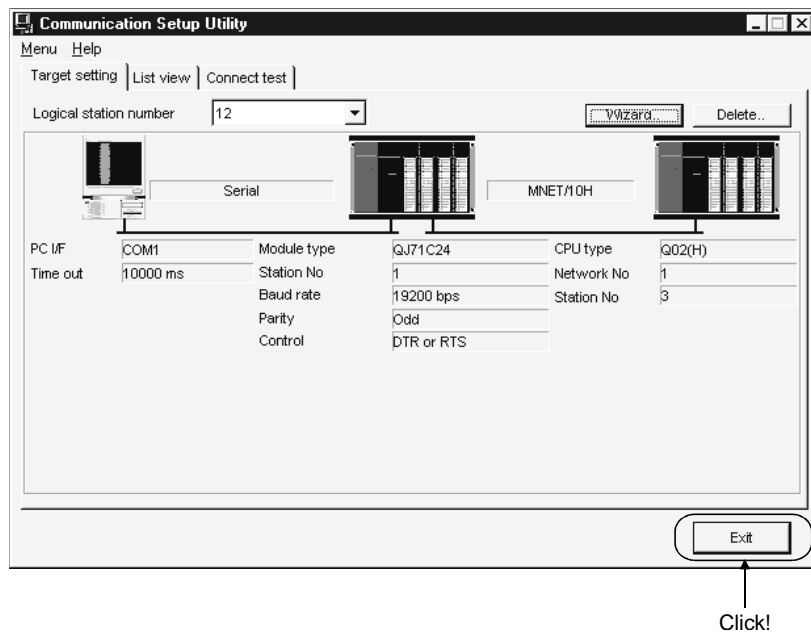

### 4.3 Confirming the Version

To confirm the version of each utility, click the [Help]-[About] menu.

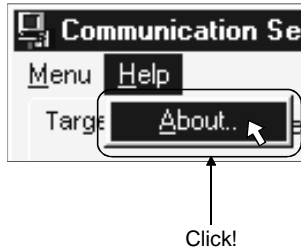

## 5 UTILITY OPERATIONS

This chapter provides how to operate the communication setup utility and PLC monitor utility.

<b>POINT</b>
Refer to "CHAPTER 6 COMMUNICATION SETTING EXAMPLES OF THE UTILITY SETTING TYPE" for communication setting examples using the communication setup utility.

### 5.1 Communication Setup Utility

This section describes how to operate and set the communication setup utility used to make communication with the utility setting type.

5.1.1 Operations on target setting screen

This screen is used to display the setting details of the logical station number set on the communication setting wizard and to edit the logical station number.

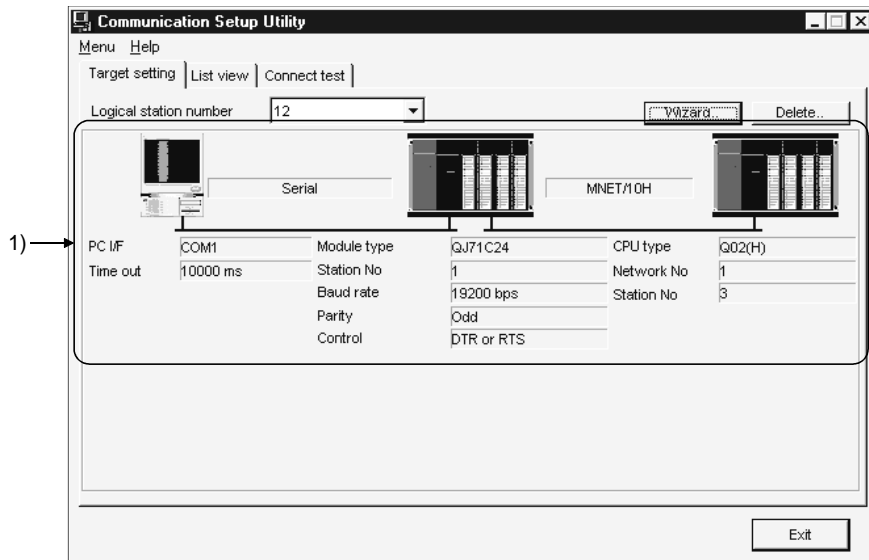

Item	Description
Logical station number	Choosing the logical station number set on the communication setting wizard shows 1) (Connection image diagram).
<b>Wizard</b>	Used to start the communication setting wizard and set the logical station number.
<b>Delete</b>	Used to delete the preset logical station number.
1) (Connection image diagram)	Shows the connection image diagram of the logical station number set on the communication setting wizard. Clicking any sketch (personal computer, PLC CPU) in the connection image diagram starts the communication setting wizard, enabling you to change the settings.

**REMARK**

For details of the communication setting wizard, refer to "Section 5.1.6 Operations on the communication setting wizard screen".

5.1.2 Operations on list view screen

This screen is used to list the logical station numbers registered, edit the logical station number, and list the properties necessary for the program setting type.

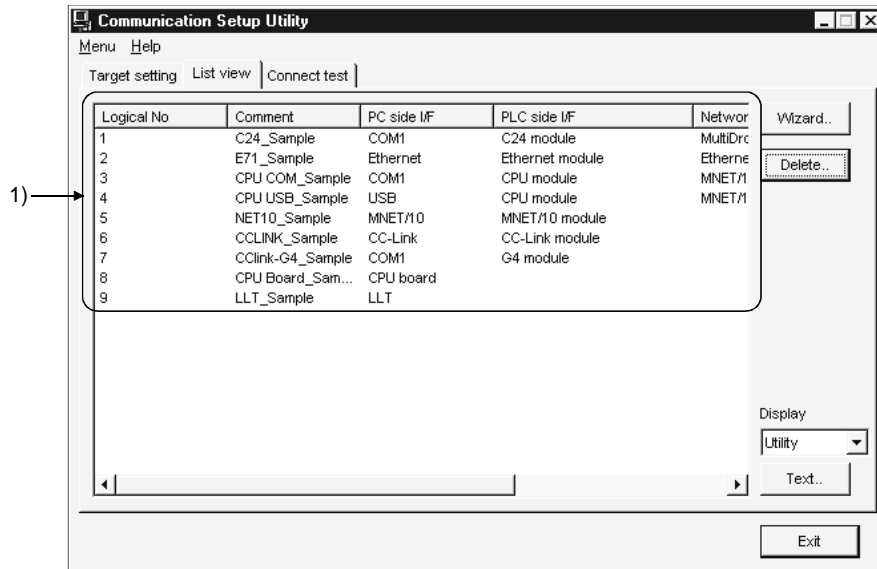

Item	Description
1) (Property list)	Shows the settings of the registered logical station numbers. Double-clicking the logical station number starts the communication setting wizard.
Wizard	Used to start the communication setting wizard and set the logical station number.
Delete	Used to delete the preset logical station number.
Display	Utility ..... Shows the settings made for the logical station numbers in 1) (Property list). Program..... Shows the property list necessary for setting with the program setting type in 1) (Property list).
Text	1) Used to save the settings of 1) (Property file) into a file in the txt format.

**REMARK**

For details of the communication setting wizard, refer to "Section 5.1.6 Operations on the communication setting wizard screen".



5.1.3 Operations on connection test screen

This screen is used to conduct a communication test on the logical station number registered.

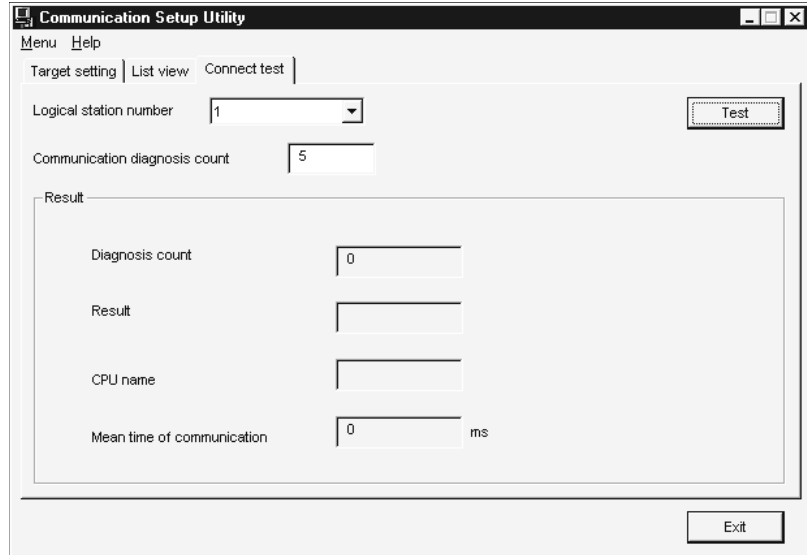

Item	Description	
Logical station number	Choose the logical station number on which a communication test will be made.	
Communication diagnosis count	Set how many times the communication test will be repeated. (Setting range: 1 to 32767, default value: 5)	
Test (Cancel)	Used to start (stop) the communication test.	
Result	Shows the result of the communication test.	
	Item	Description
	Diagnosis count	Shows the number of connections made during the communication test.
	Result	Shows the test result. An error code appears at error occurrence.
	Mean time of communication	Shows the average time taken until one communication test is established. (Unit: ms)

5.1.4 Operations on file import screen

This screen is used to reflect on the IBM-PC/AT compatible the file settings that was saved using the file export function indicated in Section 5.1.5.

(1) Selected menu item

Choose the [Menu]-[Import file] on the menu bar.

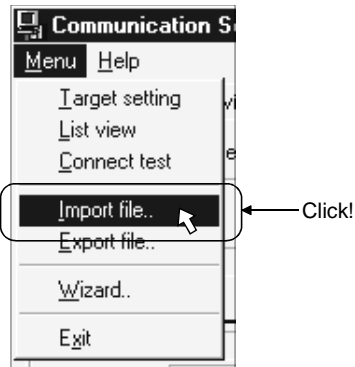

(2) Dialog box

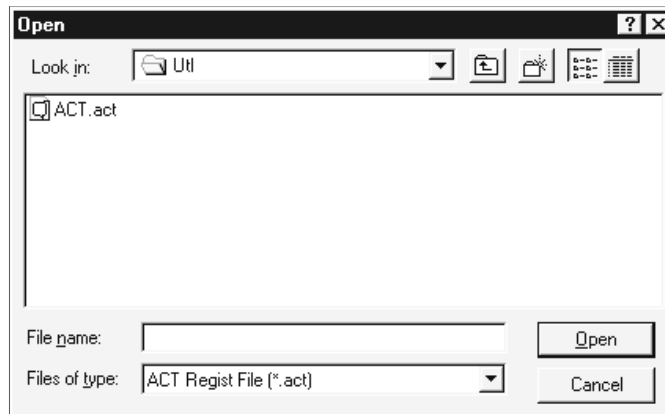

Item	Description
Look in	Specify the place where the file to be imported exists.
File name	Enter the file name to be imported.
Files of type	Set the type of the file to be imported.
Open	Used to execute import.
Cancel	Used to cancel importing the file.

5.1.5 Operations on file export screen

This screen is used to save in a file the communication settings made on the IBM-PC/AT compatible. (The file where the settings were saved is called the ACT registered file.)

This screen is used to make communication settings when you uninstall ACT or to reflect the same settings on another IBM-PC/AT compatible.

(1) Selected menu item

Choose the [Menu]-[Export file] on the menu bar.

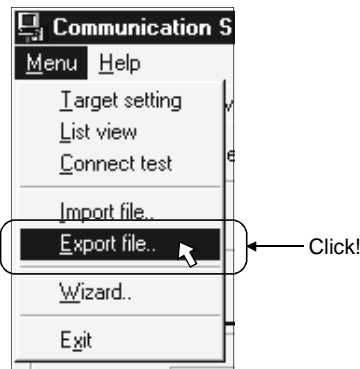

(2) Dialog box

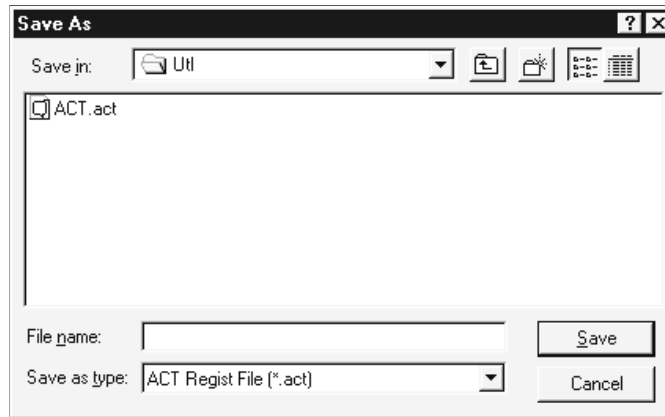

Item	Description
Save in	Specify the place where the file will be exported.
File name	Enter the file name to be saved.
Save as type	Set the type of the file to be saved.
Save	Used to export the file.
Cancel	Used to cancel exporting the file.

5.1.6 Operations on communication setting wizard screens

These screens are used to set the logical station number necessary to make communication with the utility setting type.

(1) Outline of the communication setting wizard

The logical station number necessary to make communication with the utility setting type is set in the wizard format.

The places and descriptions of the settings made on the communication setting wizard screens will be given below.

For the wizard screen settings, refer to "(3) Explanation of the communication setting wizard screens".

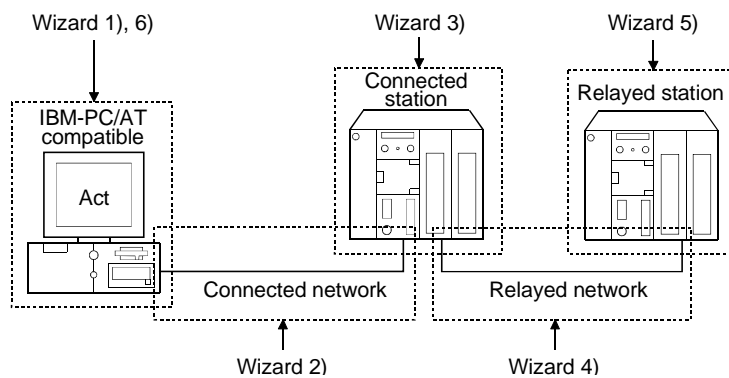

Screen Name	Description
Wizard 1)	Used to set the logical station number.
Wizard 2)	Used to set the connected network between the IBM-PC/AT compatible and connected station (PLC CPU and module).
Wizard 3)	Used to set the connected station (PLC CPU and module).
Wizard 4)	Used to set the relayed network between the connected station (PLC CPU and module) and relayed station (PLC CPU and module).
Wizard 5)	Used to set the relayed station PLC CPU.
Wizard 6)	Used to comment the logical station number.

(2) Starting procedure

Choose the [Menu]-[Wizard] on the menu bar.

(You can also start by clicking the **Wizard** button displayed on the utility screen.)

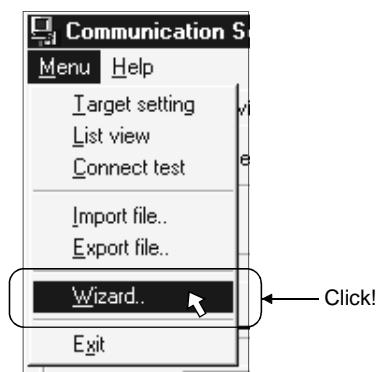

### (3) Explanation of the communication setting wizard screens

Communication setting wizard screens are shown from wizard 1) to wizard 6) in this order.

Explanation will be made in the order of the displayed communication setting wizard screens.

#### POINT

- (1) The displays or available setting items of the communication setting wizard screens change with the communication settings.  
Set all available setting items being displayed.
- (2) Some of the communication setting wizard screens may not appear depending on the settings.
- (3) If you repeat starting the communication setting wizard limitlessly, a memory shortage error may occur.  
This fault is attributable to MS-IME95 or MS-IME97 of Microsoft Corporation. If the memory shortage error has occurred, change MS-IME95 or MS-IME97 for MS-IME2000.

Start the communication setting wizard.



#### Wizard 1)

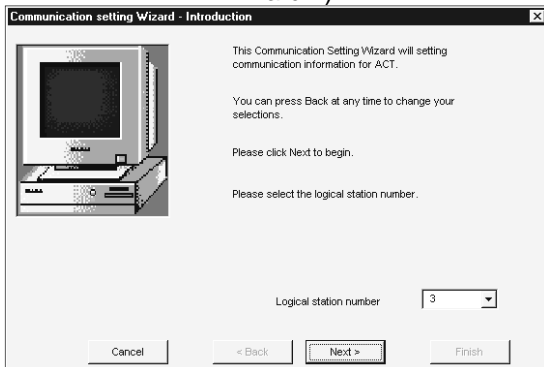

(To the next page)

- 1) Type or choose the logical station number and click the **Next>** button.

(From the preceding page)



Wizard 2)

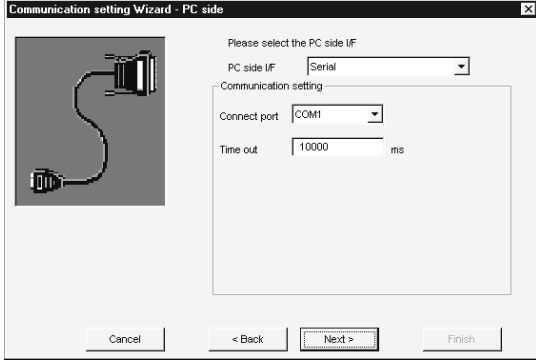

2) Choose the "PC side I/F" to communicate with.

The items shown in "Communication setting" change with the setting made in "PC side I/F".

Set all available setting items and click the **Next>** button.

The choices corresponding to the communications in "PC side I/F" are indicated below.

Setting Item	Communication Name
Serial	Computer link communication, CPU COM communication, CPU USB communication, CC-Link G4 communication
MELSECNET/10 board	MELSECNET/10 communication
CC-Link board	CC-Link communication
Ethernet board	Ethernet communication
CPU board	CPU board communication
LLT	Ladder logic test communication

Wizard 3)

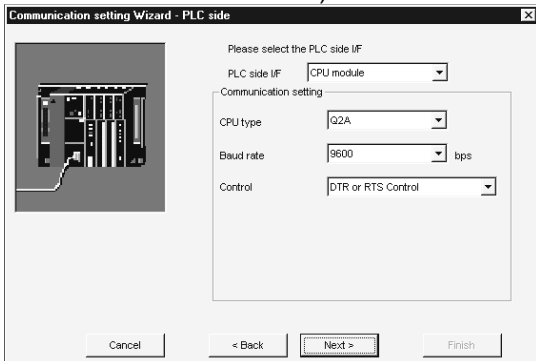

3) Wizard 3) differs in available setting items depending on the settings on Wizard 2).

Set all available setting items and click the **Next>** button.

Wizard 4)

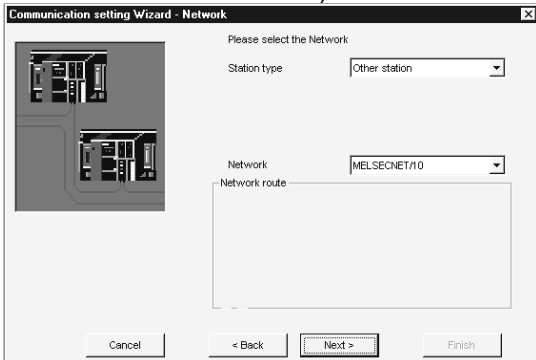

4) Wizard 4) differs in available setting items depending on the settings on Wizard 2) and Wizard 3).

Set all available setting items and click the **Next>** button.

(To the next page)

(From the preceding page)



Wizard 5)

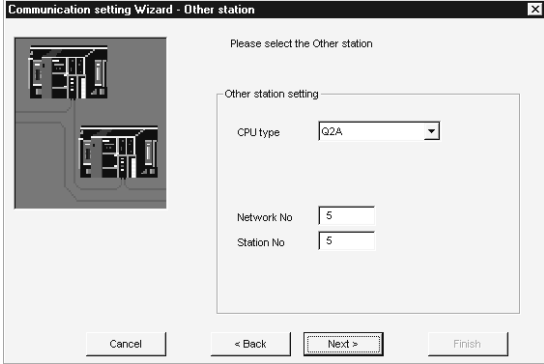

5) Wizard 5) differs in available setting items depending on the settings on Wizard 2), Wizard 3) and Wizard 4). Set all available setting items and click the **Next>** button.



Wizard 6)

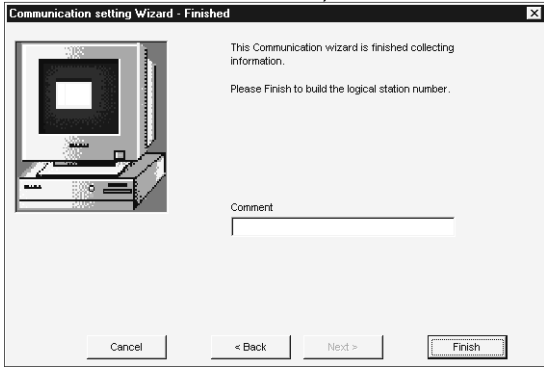

6) Comment the logical station number that was set. A comment may be entered using up to 32 characters. Enter a comment and click the **Finish** button. When you do not need a comment, click the **Finish** button without entering it.



(Registration complete)

When the registration of the logical station number is completed on the communication setting wizard, the settings are displayed on the target setting screen.

<Before registration>



<After registration>

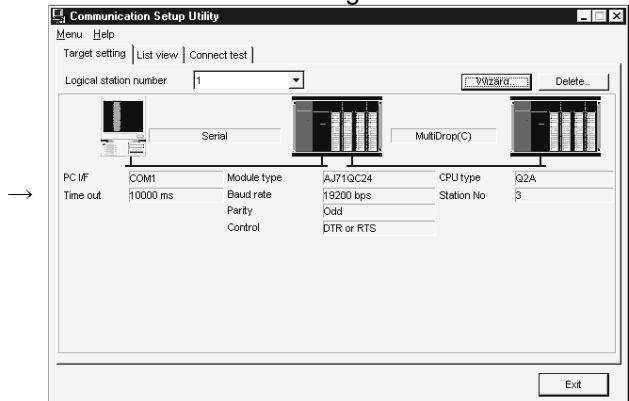

5.2 PLC Monitor Utility

This section explains how to operate and set the PLC monitor utility.

5.2.1 Operations on transfer setting screen

This screen is used to set connection from the IBM-PC/AT compatible to the PLC CPU.

(1) Selected menu item

Choose [Online]-[Transfer setting] on the menu bar.

(This screen also appears when the PLC monitor utility is started.)

(2) Dialog box

(a) When choosing the utility setting type

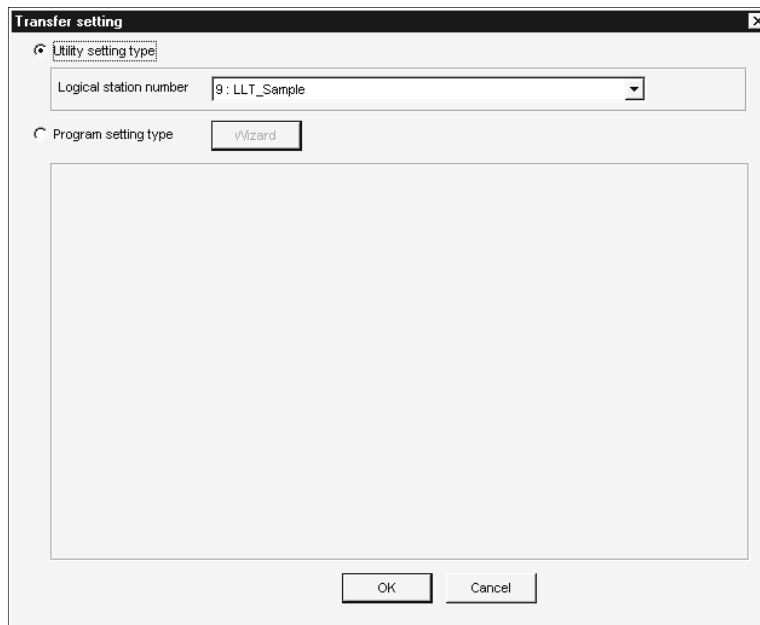

Item	Description
Utility setting type	Choose when using the logical station number set on the communication setup utility to make transfer setting.
Logical station number	Choose the logical station number set on the communication setup utility.

**POINT**

Before specifying the logical station number, confirm that the settings of the logical station number, such as the CPU type and station number, are correct on the communication setup utility.



(b) When choosing the program setting type

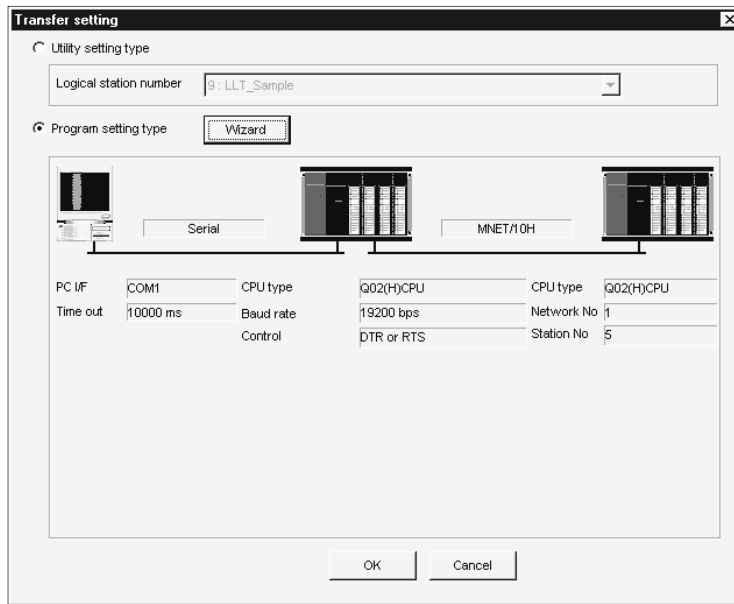

Item	Description
Program setting type	Choose when the program setting type is used to create programs.
Wizard	Used to start the communication setting wizard and make transfer setting.

**POINT**

When the program setting type is selected, clicking the PLC or personal computer sketch enables you to change the details of the transfer setting.

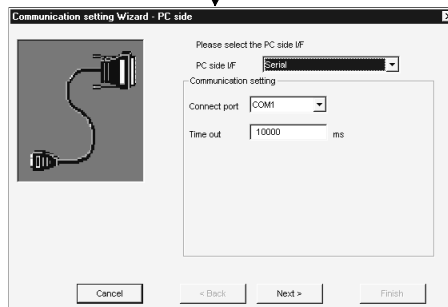
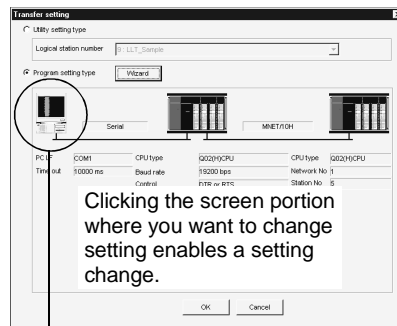

5.2.2 Operations on device batch screen

This screen is used to monitor only the specified one type of devices.

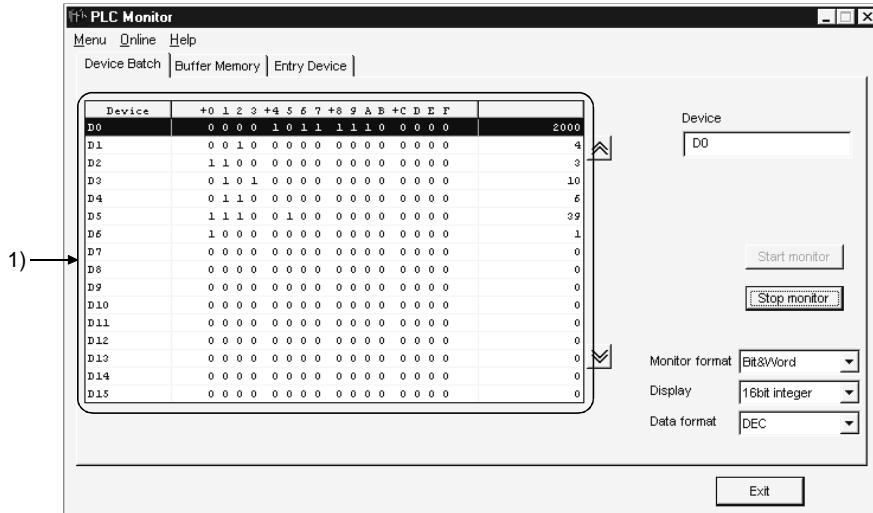

Item	Description										
Device	Enter the device name to be batch-monitored.										
<input type="button" value="Start monitor"/> <input type="button" value="Stop monitor"/>	Used to start (stop) monitor.										
Monitor format	Set the monitor format. (Default: Bit & Word) <table border="1" style="width: 100%;"> <thead> <tr> <th>Item</th> <th>Description</th> </tr> </thead> <tbody> <tr> <td>Bit &amp; Word</td> <td>Sets the monitor screen to the bit and word display.</td> </tr> <tr> <td>Bit</td> <td>Sets the monitor screen to the bit display only.</td> </tr> <tr> <td>Word</td> <td>Sets the monitor screen to the word display only.</td> </tr> </tbody> </table>	Item	Description	Bit & Word	Sets the monitor screen to the bit and word display.	Bit	Sets the monitor screen to the bit display only.	Word	Sets the monitor screen to the word display only.		
Item	Description										
Bit & Word	Sets the monitor screen to the bit and word display.										
Bit	Sets the monitor screen to the bit display only.										
Word	Sets the monitor screen to the word display only.										
Display	Set the display format of the device values to be displayed when the monitor format is "Bit & Word" or "Word". (Default: 16 bit integer) <table border="1" style="width: 100%;"> <thead> <tr> <th>Item</th> <th>Description</th> </tr> </thead> <tbody> <tr> <td>16 bit integer</td> <td>Sets to the 16-bit integer display.</td> </tr> <tr> <td>32 bit integer</td> <td>Sets to the 32-bit integer display.</td> </tr> <tr> <td>Real number</td> <td>Sets to the real number display.</td> </tr> <tr> <td>ASCII character</td> <td>Sets to the ASCII character string display.</td> </tr> </tbody> </table>	Item	Description	16 bit integer	Sets to the 16-bit integer display.	32 bit integer	Sets to the 32-bit integer display.	Real number	Sets to the real number display.	ASCII character	Sets to the ASCII character string display.
Item	Description										
16 bit integer	Sets to the 16-bit integer display.										
32 bit integer	Sets to the 32-bit integer display.										
Real number	Sets to the real number display.										
ASCII character	Sets to the ASCII character string display.										
Data format	Set the radix when the display is "16 bit integer" or "32 bit integer". (Default: DEC) <table border="1" style="width: 100%;"> <thead> <tr> <th>Item</th> <th>Description</th> </tr> </thead> <tbody> <tr> <td>DEC</td> <td>Sets to the decimal display.</td> </tr> <tr> <td>HEX</td> <td>Sets to the hexadecimal display.</td> </tr> </tbody> </table>	Item	Description	DEC	Sets to the decimal display.	HEX	Sets to the hexadecimal display.				
Item	Description										
DEC	Sets to the decimal display.										
HEX	Sets to the hexadecimal display.										

Item	Description
1) (Monitor screen)	Shows the device statuses. Clicking the device name shows the device write screen. For details of the device write screen, refer to "Section 5.2.5 Operations on device write screen".

**POINT**

- (1) For the bit device statuses, 1 indicates an ON status and 0 an OFF status.
- (2) Bit devices are monitored in units of 16 points.  
If any device outside the range supported by the PLC CPU is included in the 16 points, its value is displayed "0".
- (3) Specifying the device memory in the U\*\G\* format enables the buffer memory to be monitored.
- (4) When monitoring the set values of the timers and counters, indirectly specify the data registers.
- (5) For the X and Y devices of the FXCPU, type their device numbers in octal.
- (6) For the C devices of the FXCPU, C0 to C199 (16 bit) and C200 and later (32 bit) are displayed separately.
- (7) Devices cannot be monitored if the connection destination is not established.
- (8) During monitoring, you cannot make transfer setting.
- (9) During monitoring, "\*" flickers under the scroll button.

5.2.3 Operations on buffer memory screen

This screen is used to monitor only the specified one type of buffer memory.

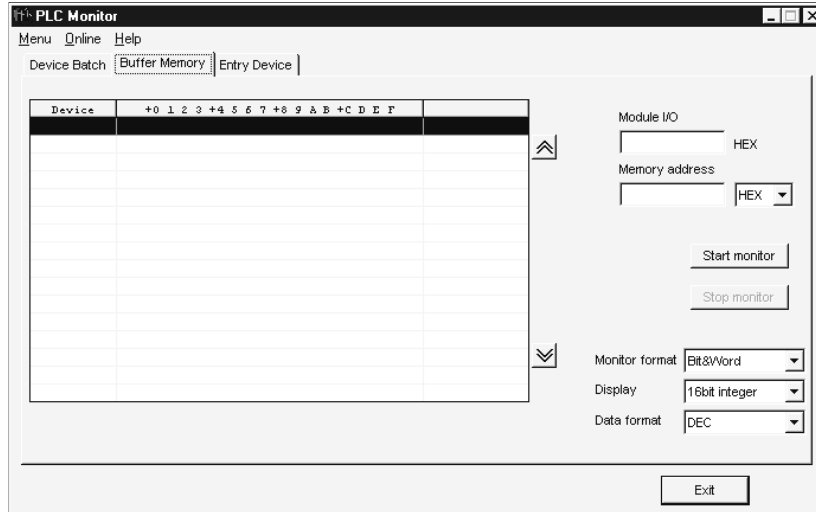

Item	Description										
Module I/O	Type the first address of the module to be monitored.										
Memory address	Enter the address of the buffer memory to be monitored in hexadecimal or decimal.										
Start monitor Stop monitor	Used to start (stop) monitor.										
Monitor format	Set the monitor format. (Default: Bit & Word) <table border="1" style="margin-left: 20px;"> <thead> <tr> <th>Item</th> <th>Description</th> </tr> </thead> <tbody> <tr> <td>Bit &amp; Word</td> <td>Sets the monitor screen to the bit and word display.</td> </tr> <tr> <td>Bit</td> <td>Sets the monitor screen to the bit display only.</td> </tr> <tr> <td>Word</td> <td>Sets the monitor screen to the word display only.</td> </tr> </tbody> </table>	Item	Description	Bit & Word	Sets the monitor screen to the bit and word display.	Bit	Sets the monitor screen to the bit display only.	Word	Sets the monitor screen to the word display only.		
Item	Description										
Bit & Word	Sets the monitor screen to the bit and word display.										
Bit	Sets the monitor screen to the bit display only.										
Word	Sets the monitor screen to the word display only.										
Display	Set the display format of the device values to be displayed when the monitor format is "Bit & Word" or "Word". (Default: 16 bit integer) <table border="1" style="margin-left: 20px;"> <thead> <tr> <th>Item</th> <th>Description</th> </tr> </thead> <tbody> <tr> <td>16 bit integer</td> <td>Sets to the 16-bit integer display.</td> </tr> <tr> <td>32 bit integer</td> <td>Sets to the 32-bit integer display.</td> </tr> <tr> <td>Real number</td> <td>Sets to the real number display.</td> </tr> <tr> <td>ASCII character</td> <td>Sets to the ASCII character string display.</td> </tr> </tbody> </table>	Item	Description	16 bit integer	Sets to the 16-bit integer display.	32 bit integer	Sets to the 32-bit integer display.	Real number	Sets to the real number display.	ASCII character	Sets to the ASCII character string display.
Item	Description										
16 bit integer	Sets to the 16-bit integer display.										
32 bit integer	Sets to the 32-bit integer display.										
Real number	Sets to the real number display.										
ASCII character	Sets to the ASCII character string display.										
Data format	Set the radix when the display is "16 bit integer" or "32 bit integer". (Default: DEC) <table border="1" style="margin-left: 20px;"> <thead> <tr> <th>Item</th> <th>Description</th> </tr> </thead> <tbody> <tr> <td>DEC</td> <td>Sets to the decimal display.</td> </tr> <tr> <td>HEX</td> <td>Sets to the hexadecimal display.</td> </tr> </tbody> </table>	Item	Description	DEC	Sets to the decimal display.	HEX	Sets to the hexadecimal display.				
Item	Description										
DEC	Sets to the decimal display.										
HEX	Sets to the hexadecimal display.										
1) (Monitor screen)	Shows the buffer memory status.										

**POINT**

- (1) For the bit device statuses, 1 indicates an ON status and 0 an OFF status.
- (2) For access to the FXCPU, enter the block number of the special expansion equipment into Module I/O.
- (3) Devices cannot be monitored if the connection destination is not established.
- (4) During monitoring, you cannot make transfer setting.
- (5) During monitoring, "\*" flickers under the scroll button.

5.2.4 Operation on entry device screen

This screen is used to monitor the specified devices on a single screen at the same time.

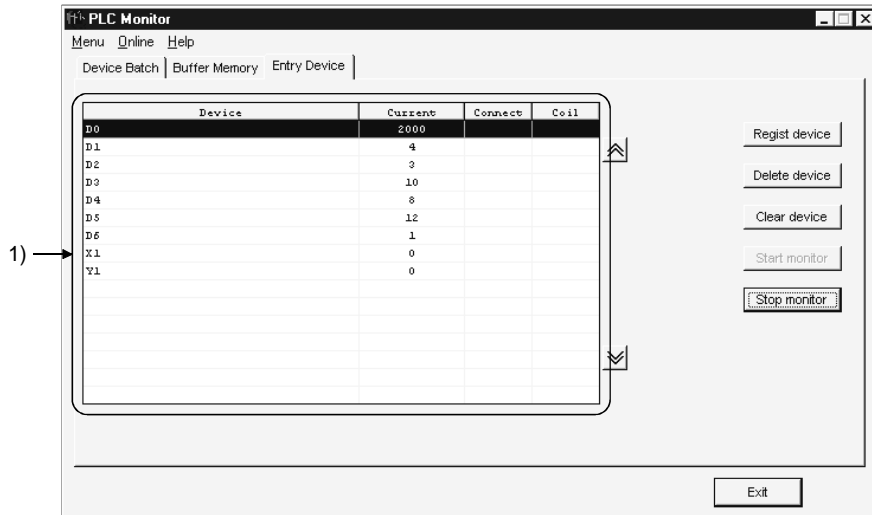

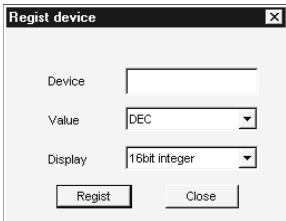
Item	Description																															
<b>Regist device</b>	<p>Used to register the device to be monitored.</p> <p>Clicking the <b>Regist device</b> button shows the following screen.</p> <table border="1" data-bbox="758 1048 1430 1709"> <thead> <tr> <th>Item</th> <th>Description</th> </tr> </thead> <tbody> <tr> <td>Device</td> <td>Type the device to be registered.</td> </tr> <tr> <td rowspan="3">Value</td> <td>Set the value to be entered when a word device is specified. (Default: DEC)</td> </tr> <tr> <td> <table border="1"> <thead> <tr> <th>Item</th> <th>Description</th> </tr> </thead> <tbody> <tr> <td>DEC</td> <td>Sets to decimal.</td> </tr> <tr> <td>HEX</td> <td>Sets to hexadecimal.</td> </tr> </tbody> </table> </td> </tr> <tr> <td>Display</td> <td>Set the display format when a word device is specified. (Default: 16 bit integer)</td> </tr> <tr> <td rowspan="4">Display</td> <td> <table border="1"> <thead> <tr> <th>Item</th> <th>Description</th> </tr> </thead> <tbody> <tr> <td>16 bit integer</td> <td>Sets to the 16-bit integer display.</td> </tr> <tr> <td>32 bit integer</td> <td>Sets to the 32-bit integer display.</td> </tr> <tr> <td>Real number</td> <td>Sets to the real number display.</td> </tr> <tr> <td>ASCII character</td> <td>Sets to the ASCII character string display.</td> </tr> </tbody> </table> </td> </tr> <tr> <td><b>Regist</b></td> <td>Used to register the device.</td> </tr> <tr> <td><b>Close</b></td> <td>Used to close the dialog box.</td> </tr> </tbody> </table> 	Item	Description	Device	Type the device to be registered.	Value	Set the value to be entered when a word device is specified. (Default: DEC)	<table border="1"> <thead> <tr> <th>Item</th> <th>Description</th> </tr> </thead> <tbody> <tr> <td>DEC</td> <td>Sets to decimal.</td> </tr> <tr> <td>HEX</td> <td>Sets to hexadecimal.</td> </tr> </tbody> </table>	Item	Description	DEC	Sets to decimal.	HEX	Sets to hexadecimal.	Display	Set the display format when a word device is specified. (Default: 16 bit integer)	Display	<table border="1"> <thead> <tr> <th>Item</th> <th>Description</th> </tr> </thead> <tbody> <tr> <td>16 bit integer</td> <td>Sets to the 16-bit integer display.</td> </tr> <tr> <td>32 bit integer</td> <td>Sets to the 32-bit integer display.</td> </tr> <tr> <td>Real number</td> <td>Sets to the real number display.</td> </tr> <tr> <td>ASCII character</td> <td>Sets to the ASCII character string display.</td> </tr> </tbody> </table>	Item	Description	16 bit integer	Sets to the 16-bit integer display.	32 bit integer	Sets to the 32-bit integer display.	Real number	Sets to the real number display.	ASCII character	Sets to the ASCII character string display.	<b>Regist</b>	Used to register the device.	<b>Close</b>	Used to close the dialog box.
Item	Description																															
Device	Type the device to be registered.																															
Value	Set the value to be entered when a word device is specified. (Default: DEC)																															
	<table border="1"> <thead> <tr> <th>Item</th> <th>Description</th> </tr> </thead> <tbody> <tr> <td>DEC</td> <td>Sets to decimal.</td> </tr> <tr> <td>HEX</td> <td>Sets to hexadecimal.</td> </tr> </tbody> </table>	Item	Description	DEC	Sets to decimal.	HEX	Sets to hexadecimal.																									
	Item	Description																														
DEC	Sets to decimal.																															
HEX	Sets to hexadecimal.																															
Display	Set the display format when a word device is specified. (Default: 16 bit integer)																															
Display	<table border="1"> <thead> <tr> <th>Item</th> <th>Description</th> </tr> </thead> <tbody> <tr> <td>16 bit integer</td> <td>Sets to the 16-bit integer display.</td> </tr> <tr> <td>32 bit integer</td> <td>Sets to the 32-bit integer display.</td> </tr> <tr> <td>Real number</td> <td>Sets to the real number display.</td> </tr> <tr> <td>ASCII character</td> <td>Sets to the ASCII character string display.</td> </tr> </tbody> </table>	Item	Description	16 bit integer	Sets to the 16-bit integer display.	32 bit integer	Sets to the 32-bit integer display.	Real number	Sets to the real number display.	ASCII character	Sets to the ASCII character string display.																					
	Item	Description																														
	16 bit integer	Sets to the 16-bit integer display.																														
	32 bit integer	Sets to the 32-bit integer display.																														
Real number	Sets to the real number display.																															
ASCII character	Sets to the ASCII character string display.																															
<b>Regist</b>	Used to register the device.																															
<b>Close</b>	Used to close the dialog box.																															
<b>Delete device</b>	Used to delete the device to be monitored.																															
<b>Clear device</b>	Used to delete all devices registered in device entry monitor from the monitor screen.																															
<b>Start monitor</b>	Used to start (stop) monitor.																															
<b>Stop monitor</b>																																
1) (Monitor screen)	<p>Shows the device statuses.</p> <p>Clicking the device name shows the device write screen.</p> <p>For details of the device write screen, refer to "Section 5.2.5 Operations on device write screen".</p>																															

POINT
-------

- |   |
|---|
| <ul style="list-style-type: none"><li>(1) When monitoring the set values of the timers and counters, indirectly specify the data registers.</li><li>(2) Devices cannot be monitored if the connection destination is not established.</li><li>(3) During monitoring, you cannot make transfer setting.</li><li>(4) During monitoring, "*" flickers under the scroll button.</li></ul> |
|---|

5.2.5 Operations on device write screen

This screen is used to change the ON/OFF of a bit device or the present value of a word device or buffer memory.

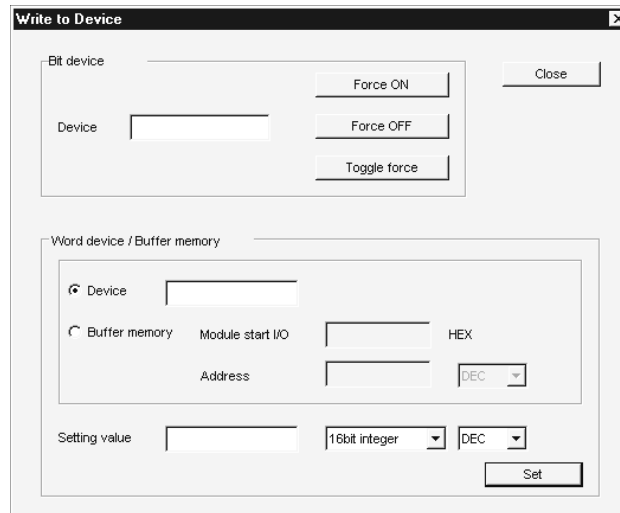

Item		Description								
Bit device	Device	Enter the device name.								
	<input type="button" value="Force ON"/>	Used to forcibly change the specified device to the ON status.								
	<input type="button" value="Force OFF"/>	Used to forcibly change the specified device to the OFF status.								
	<input type="button" value="Toggle force"/>	Used to forcibly change the specified device from the ON to OFF status or from the OFF to ON status.								
Word device/Buffer memory	Device	Choosing "Device" enables you to enter the word device to which write will be performed.								
	Buffer memory	Choosing "Buffer memory" enables you to enter the module's first I/O and buffer memory address.								
	Setting value	Type the value to be written. The input range is as indicated below.								
	<table border="1"> <thead> <tr> <th>Item</th> <th>Description</th> </tr> </thead> <tbody> <tr> <td>16 bit integer</td> <td>-32768 to 32767</td> </tr> <tr> <td>32 bit integer</td> <td>-2147483648 to 2147483647</td> </tr> <tr> <td>Real number</td> <td>1.175494351e-38 to 3.402823466e+33 Number of valid digits: 13 digits (max. 13 characters displayed)</td> </tr> </tbody> </table>		Item	Description	16 bit integer	-32768 to 32767	32 bit integer	-2147483648 to 2147483647	Real number	1.175494351e-38 to 3.402823466e+33 Number of valid digits: 13 digits (max. 13 characters displayed)
	Item	Description								
16 bit integer	-32768 to 32767									
32 bit integer	-2147483648 to 2147483647									
Real number	1.175494351e-38 to 3.402823466e+33 Number of valid digits: 13 digits (max. 13 characters displayed)									
<input type="button" value="Set"/>	Used to write the set data.									



5.2.6 Operations on clock setting screen

This screen is used to read or change the clock data of the PLC.

(1) Selected menu item

Choose [Online]-[Time setting] on the menu bar.

(2) Dialog box

The screen provided for explanation is the one displayed when the QCPU (Q mode) is connected.



Item	Description
PC Time	Shows the time of the personal computer. (Write disabled)
PLC Time	Shows the time of the PLC.
<b>Regist</b>	Used to write the "PLC Time" information to the PLC CPU.
<b>Close</b>	Used to close the clock setting screen.

<b>POINT</b>	Clock setting cannot be made for ladder logic test communication. Only the personal computer time is displayed.
--------------	--

## 6 COMMUNICATION SETTING EXAMPLES OF THE UTILITY SETTING TYPE

This chapter explains the setting procedure and setting example of each communication path when the utility setting type is used for programming.

## 6.1 Computer Link Communication

This section provides the computer link communication procedure and its setting example using the utility setting type.

## 6.1.1 Switch settings of computer link modules

This section gives the switch settings of computer link modules for use of ACT. The following sketches are used to explain each module.

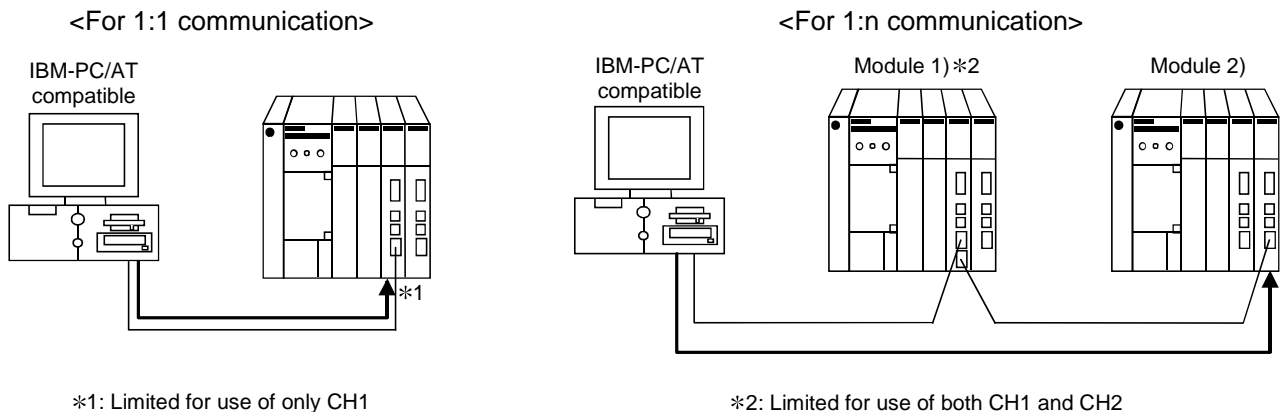

<b>POINT</b>
When using ACT, the settings other than "As set by user" in the tables are fixed as given in the tables.

(1) C24, UC24

Switch *1		Settings				
		For 1:1 communication		For 1:n communication		
				Module 1)	Module 2)	
Mode setting switch		1 (format 1)	A (format 1)	5 (format 1)		
Station number setting switches		0	As set by user			
Transmission specifications setting switches	Main channel setting	OFF(RS-232C)	OFF(RS-232C)	OFF(RS-422)		
	Data bit setting	As set by user	As set by user *2			
	Transmission speed setting	As set by user	As set by user *2			
	Parity bit yes/no setting	As set by user	As set by user *2			
	Stop bit setting	As set by user	As set by user *2			
	Sum check yes/no setting	As set by user	As set by user *2			
	Online change enable/disable setting	As set by user				
	Computer link/multidrop setting	ON (computer link)	ON (computer link)	ON (computer link)		

\*1: For switch numbers, refer to the computer link module manual.

\*2: Make the same settings to Module 1 and Module 2.

(2) QC24(N)

Switch (Switch Number)		Settings					
		For 1:1 communication		For 1:n communication			
				Module 1)		Module 2)	
		CH1 side	CH2 side	CH1 side	CH2 side	CH1 side	CH2 side
Mode setting switch		5(format 5)		0 or 5 (format 5)	5(format 5)	5(format 5)	
Station number setting switches		0		As set by user			
Transmission specifications setting switches	Operation setting switch (SW01)	OFF (independent operation)		OFF (independent operation)	ON or OFF *1	OFF (independent operation)	
	Data bit setting (SW02)	As set by user		As set by user *2			
	Parity bit yes/no setting (SW03)	As set by user		As set by user *2			
	Even parity/odd parity setting (SW04)	As set by user		As set by user *2			
	Stop bit setting (SW05)	As set by user		As set by user *2			
	Sum check yes/no setting (SW06)	As set by user		As set by user *2			
	Online change enable/disable setting (SW07)	As set by user					
	Setting change enable/disable setting (SW08)	As set by user		As set by user *2			
	Transmission speed setting (SW09 to SW12)	As set by user		As set by user *2			
— (SW13 to SW15)		All OFF					

\*1: Set to ON if the CH1 side mode setting switch setting is 0 or to OFF if the setting is 5 (format 5).

\*2: Make the same settings to Module 1 and Module 2.

(3) Q series-compatible C24  
 (a) For 1:1 communication

Item	Settings		Set Value
	b15 to b8	b7 to b0	
Switch 1	CH1 communication speed	CH1 transmission setting * 1	0000H
Switch 2	—	CH1 communications protocol	0000H
Switch 3	CH2 communication speed	CH2 transmission setting * 1	0000H*2
Switch 4	—	CH2 communications protocol	0000H*2
Switch 5	Module station number		0000H

\*1: Settings of CH1 and CH2 are indicated below.

\*2: When using CH2, enter any value set by the user.

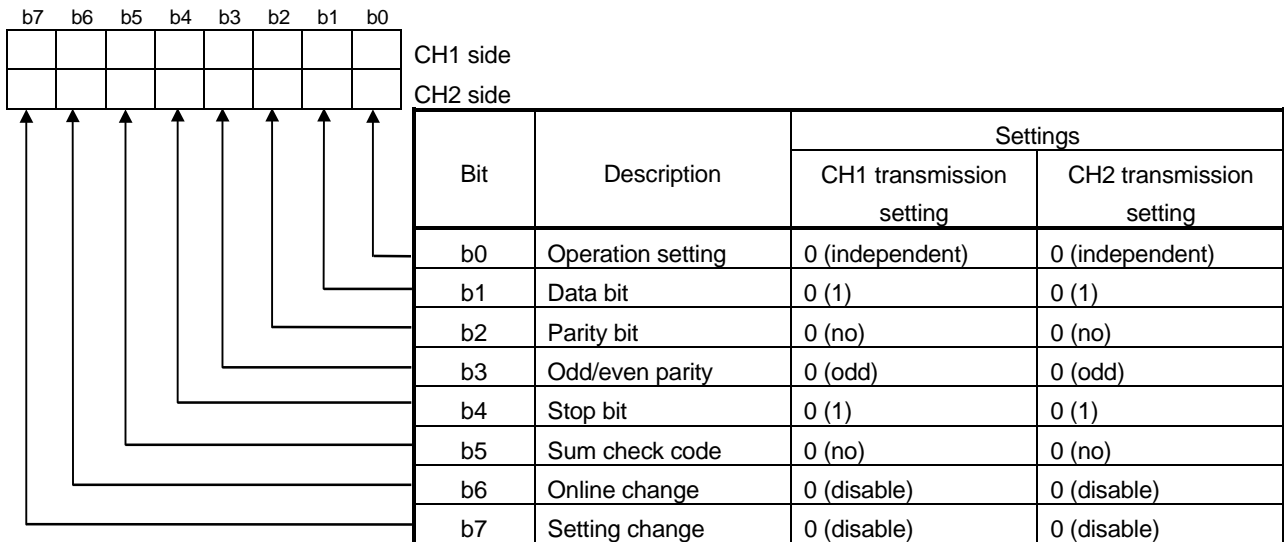

(b) For 1:n communication

Module 1)

Item	Settings		Set Value	
	b15 to b8	b7 to b0	Synchronous operation	Independent operation
Switch 1	CH1 communication speed	CH1 transmission setting* 1	0726H	0726H
Switch 2	—	CH1 communications protocol	0008H	0000H
Switch 3	CH2 communication speed	CH2 transmission setting* 1	0727H	0726H
Switch 4	—	CH2 communications protocol	0000H	0005H
Switch 5	Module station number		As set by user	0000H

\* 1: Settings of CH1 and CH2 are indicated below.

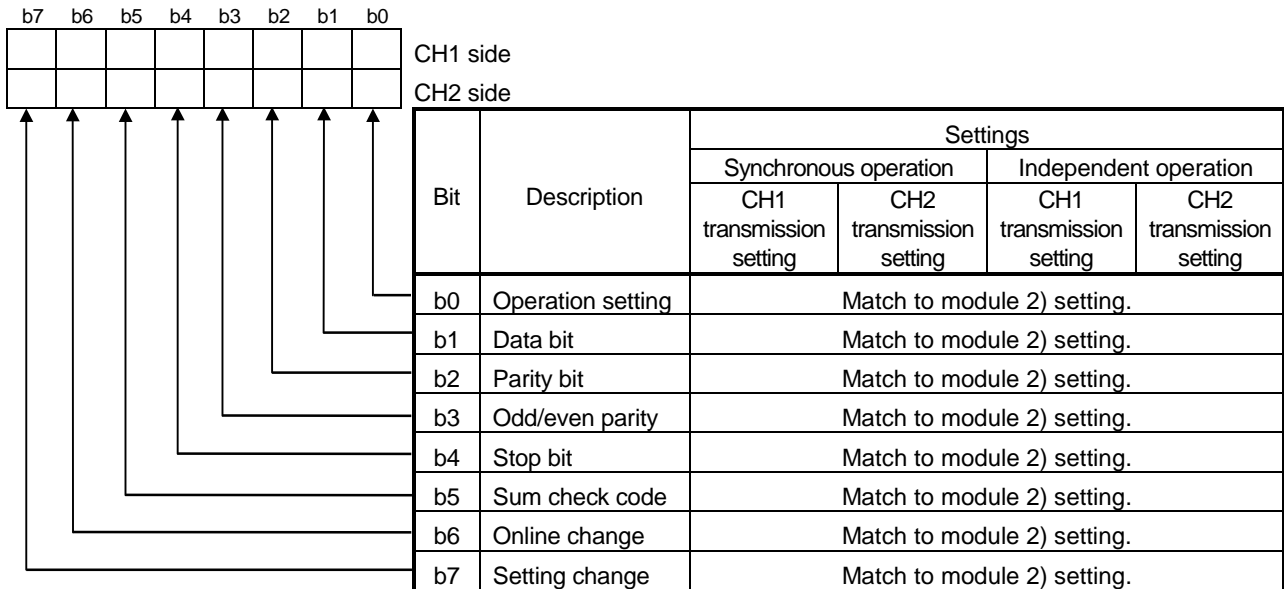

Module 2)

Item	Settings		Set Value	
	b15 to b8	b7 to b0	Synchronous operation	Independent operation
Switch 1	CH1 communication speed	CH1 transmission setting*1	0726H	0726H
Switch 2	—	CH1 communications protocol	0008H	0000H
Switch 3	CH2 communication speed	CH2 transmission setting*1	0727H	0726H
Switch 4	—	CH2 communications protocol	0000H	0005H
Switch 5	Module station number		As set by user	

\*1: Settings of CH1 and CH2 are indicated below.

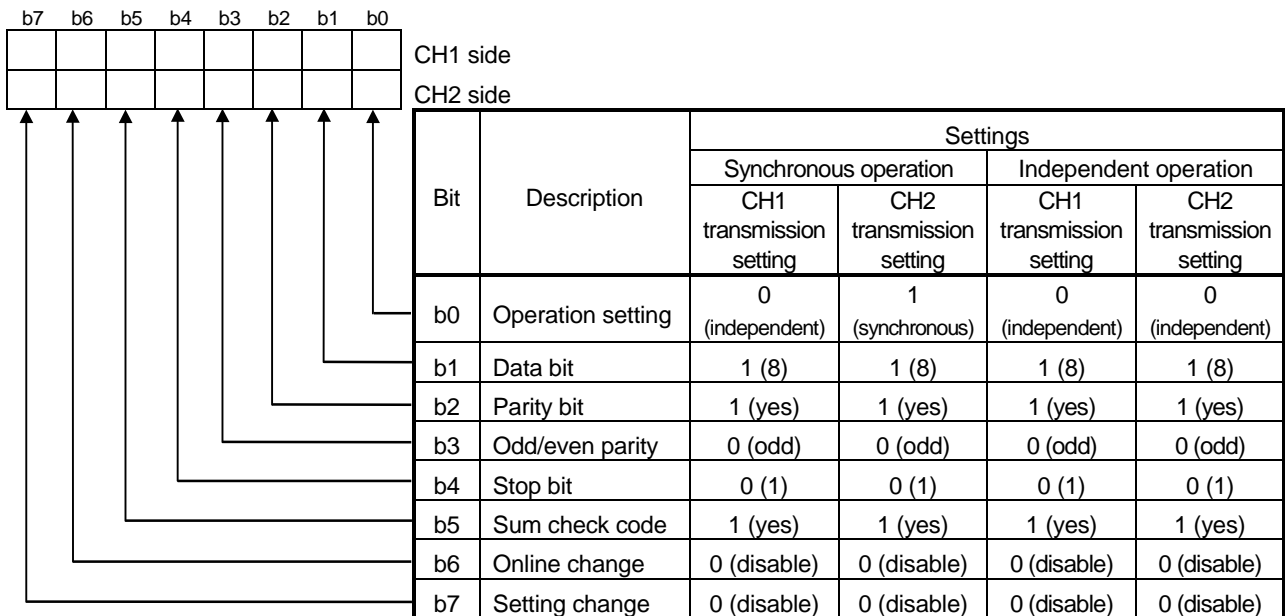

6.1.2 Accessing procedure

The procedure for making access to the PLC CPU using computer link communication will be explained in the following order.

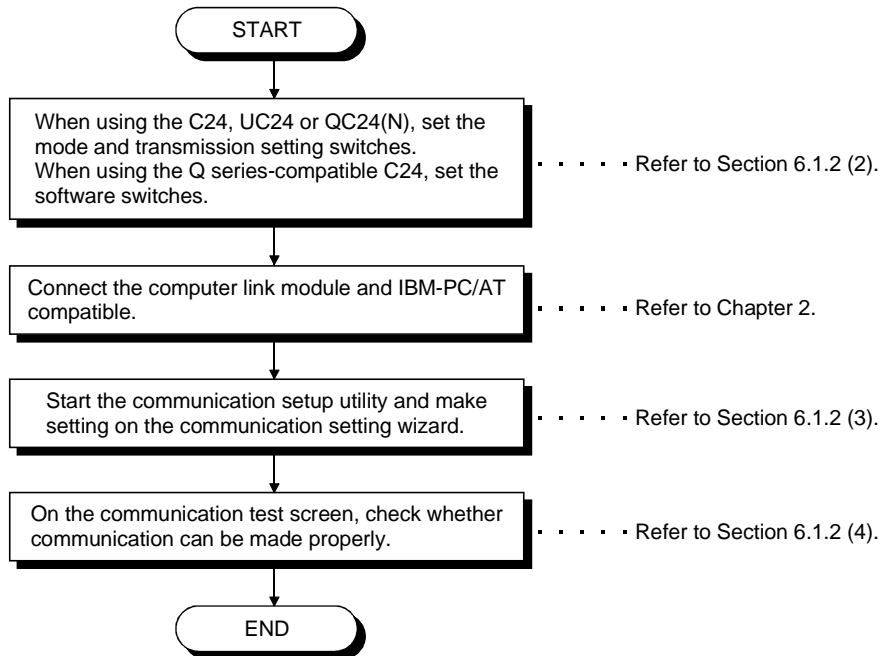

(1) System examples

The following system examples are used in this section.

The explanation given in "(3) Setting the logical station number (Setting on communication setting wizard)" and later uses the system example for 1:n communication.

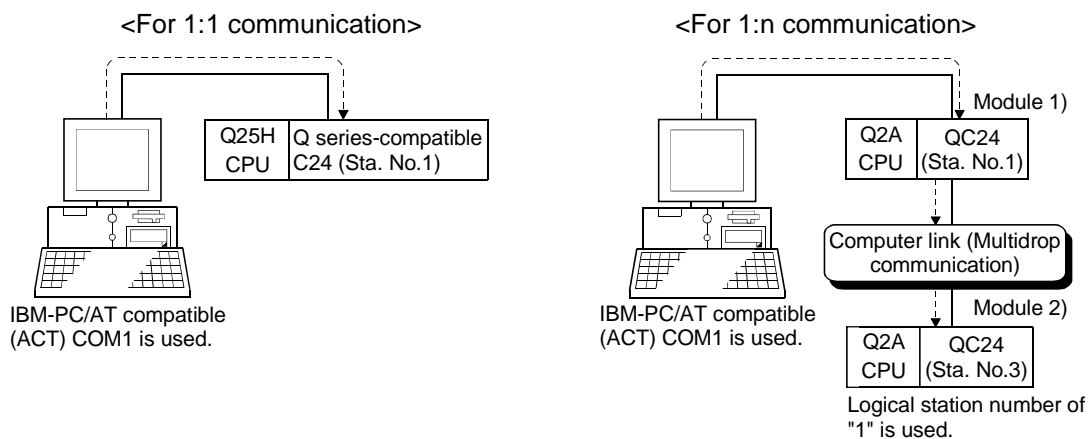

(2) Making the switch settings of the computer link module  
 (a) For 1:1 communication

Item	Settings		Set Value
	b15 to b8	b7 to b0	
Switch 1	CH1 communication speed	CH1 transmission setting * 1	0000H
Switch 2	—	CH1 communications protocol	0000H
Switch 3	CH2 communication speed	CH2 transmission setting * 1	0000H
Switch 4	—	CH2 communications protocol	0000H
Switch 5	Module station number		0000H

\*1: Settings of CH1 and CH2 are indicated below.

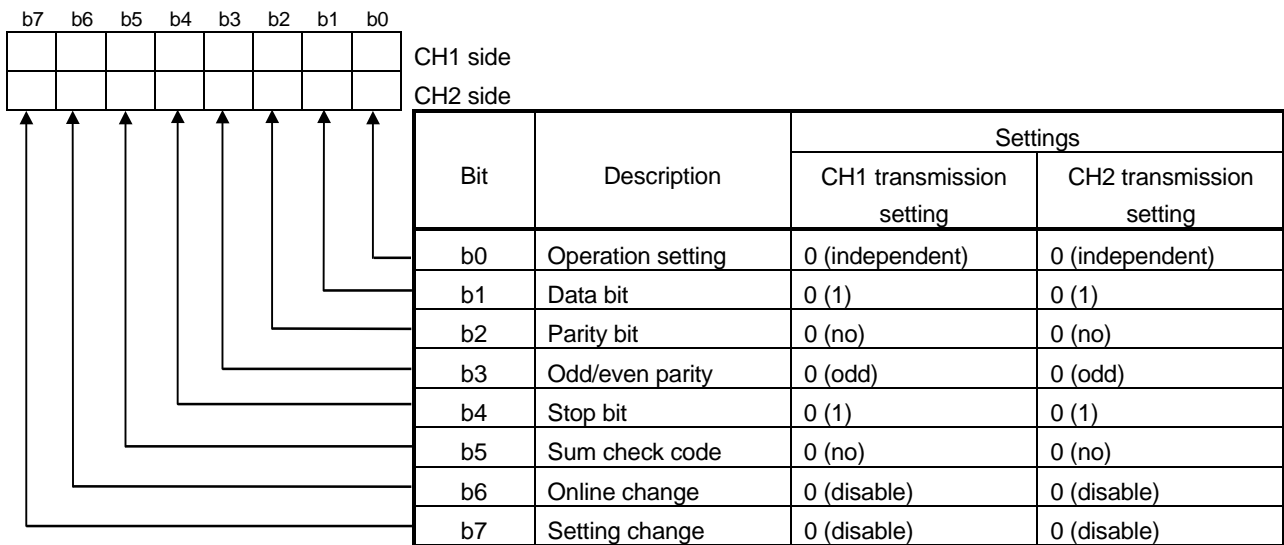



(b) For 1:n communication

Switch (Switch Number)		Settings																				
		Module 1)		Module 2)																		
		CH1 side	CH2 side	CH1 side	CH2 side																	
Mode setting switch		0	5 (format 5)	5 (format 5)																		
Station number setting switches		1		3																		
Transmission specifications setting switches	Operation setting switch (SW01)	OFF (independent operation)	ON (synchronous operation)	OFF (independent operation)																		
	Data bit setting (SW02)	ON (8 bit)		ON (8 bit)																		
	Parity bit yes/no setting (SW03)	ON (yes)		ON (yes)																		
	Even parity/odd parity setting (SW04)	OFF (odd)		OFF (odd)																		
	Stop bit setting (SW05)	OFF (1 bit)		OFF (1 bit)																		
	Sum check yes/no setting (SW06)	ON (yes)		ON (yes)																		
	Online change enable/disable setting (SW07)	ON (enable)		ON (enable)																		
	Setting change enable/disable setting (SW08)	OFF (disable)		OFF (disable)																		
	Transmission speed setting (SW09 to SW12)	19200bps		19200bps																		
		<table border="1"> <thead> <tr> <th>SW</th> <th>Setting</th> </tr> </thead> <tbody> <tr> <td>SW09</td> <td>OFF</td> </tr> <tr> <td>SW10</td> <td>ON</td> </tr> <tr> <td>SW11</td> <td>ON</td> </tr> <tr> <td>SW12</td> <td>OFF</td> </tr> </tbody> </table>	SW	Setting	SW09	OFF	SW10	ON	SW11	ON	SW12	OFF	<table border="1"> <thead> <tr> <th>SW</th> <th>Setting</th> </tr> </thead> <tbody> <tr> <td>SW09</td> <td>OFF</td> </tr> <tr> <td>SW10</td> <td>ON</td> </tr> <tr> <td>SW11</td> <td>ON</td> </tr> <tr> <td>SW12</td> <td>OFF</td> </tr> </tbody> </table>	SW	Setting	SW09	OFF	SW10	ON	SW11	ON	SW12
SW	Setting																					
SW09	OFF																					
SW10	ON																					
SW11	ON																					
SW12	OFF																					
SW	Setting																					
SW09	OFF																					
SW10	ON																					
SW11	ON																					
SW12	OFF																					
	— (SW13 to SW15)	All OFF		All OFF																		

(3) Setting the logical station number (Setting on communication setting wizard)

Logical station number setting will be described using the system example for 1:n communication.

1) Start the communication setup utility and choose the communication setting wizard.

2) Type "1" in Logical station number and click the **Next>** button.

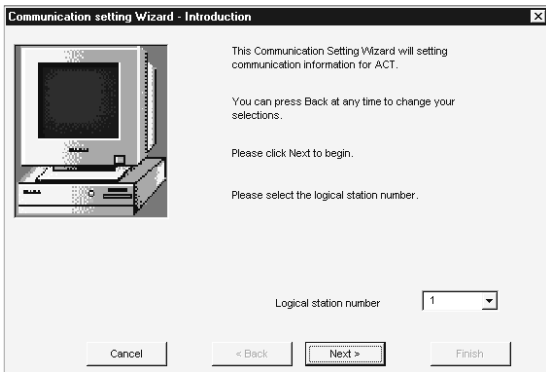

3) Make settings as indicated below and click the **Next>** button.

PC side I/F : Serial  
 Connect port : COM1  
 Time out : 10000

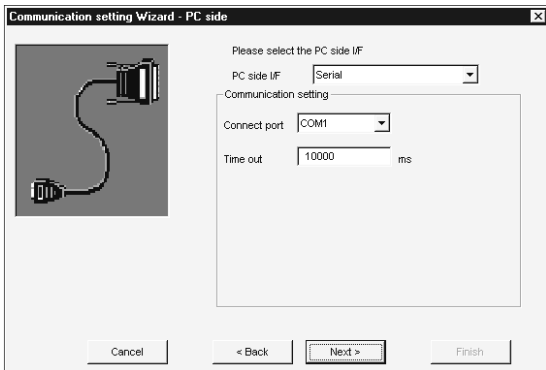

4) Make settings as indicated below and click the **Next>** button.

PLC side I/F : C24 module  
 Module type : AJ71QC24  
 Station No : 1  
 Baud rate : 19200  
 Parity : Odd  
 Control : DTR or RTS Control

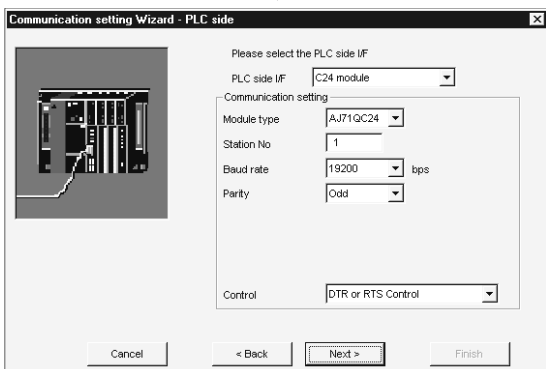

(To the next page)

(From the preceding page)

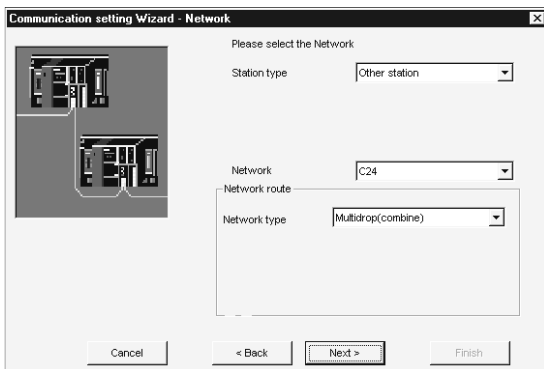

5) Make settings as indicated below and click the **Next>** button.

Station type : Other station  
Network route : C24  
Network type : Multidrop(combine)

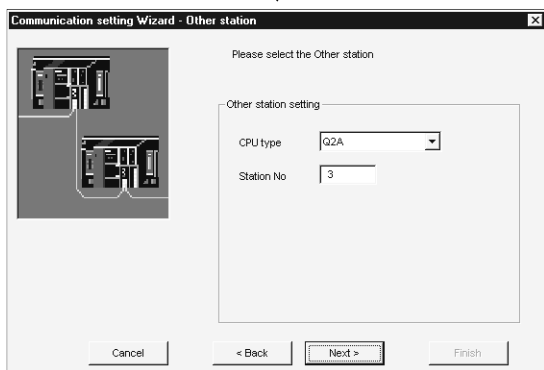

6) Make settings as indicated below and click the **Next>** button.

CPU type : Q2A  
Station No : 3

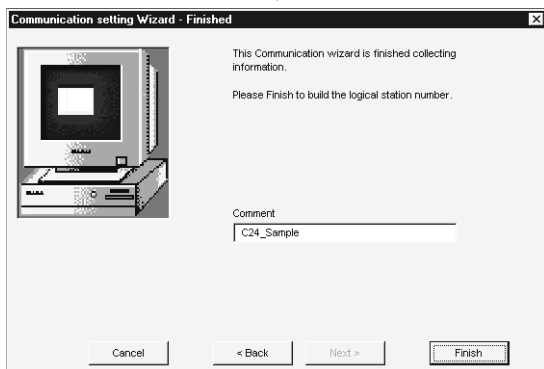

7) Enter a comment and click the **Finish** button.

(Registration complete)

(4) Checking the logical station number settings (Conducting a communication test)

Using the logical station number set in (3), check whether the computer link communication settings are correct or not.

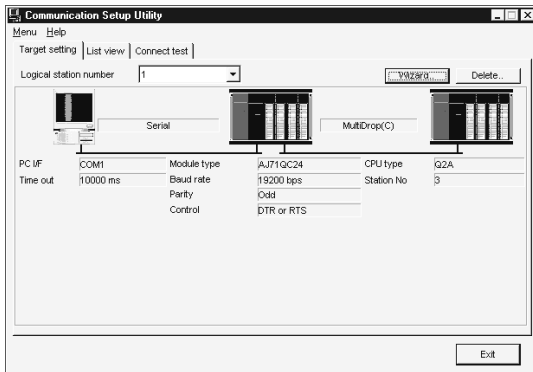

- 1) Display the target setting screen and choose the logical station number "1".  
Check whether the logical station number settings are correct or not.

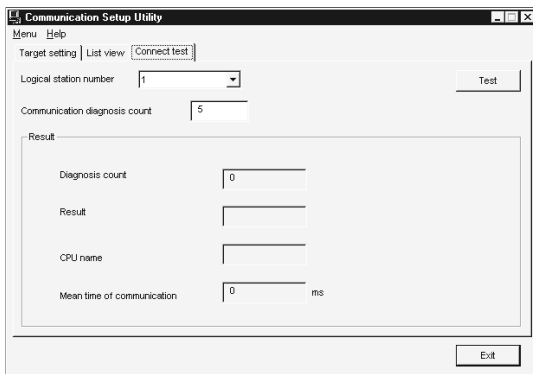

- 2) Show the connection test screen and set the logical station number "1".

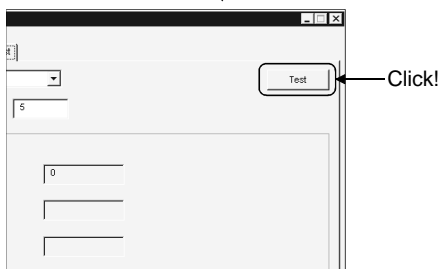

- 3) Click the **Test** button to check that communication is being made properly.  
If an error occurred, check the error code and remove the error. The error code appears in Result. (At normal termination, "0x00000000" appears in Result.)  
Refer to the programming manual for error code details.

(Communication test complete)

- 4) Through the above steps, you could confirm that the logical station number settings were correct.  
Using the set logical station number, you can create user programs and collect device information using the PLC monitor utility.

## 6.2 Ethernet Communication

This section provides the Ethernet communication procedure and its setting example using the utility setting type.

### 6.2.1 Switch settings of Ethernet modules

This section gives the switch settings of Ethernet modules for use of ACT.

#### POINT

When using ACT, the settings other than "As set by user" in the tables are fixed as given in the tables.

#### (1) Q series-compatible E71

Set the Q series-compatible E71 in "MNET/10H Ethernet module count setting" of GPPW.

#### (2) QE71

Switch (Switch Number)		Setting	
		TCP/IP	UDP/IP
Operation mode setting switch		0 (online)	0 (online)
Communications condition setting switches	Line processing selection for TCP time-out error (SW1)	OFF	OFF
	Data code setting (SW2)	ON (ASCII code)	As set by user
	Automatic start mode setting (SW3)	OFF	OFF or ON* 1
	— (SW4 to SW6)	All OFF	All OFF
	CPU communications timing setting (SW7)	ON	ON
	Initial timing setting (SW8)	OFF	OFF

\*1: Set to "ON" when parameter setting was made on GPPW or the like, or to "OFF" when a sequence program is used for setting.

#### (3) E71

Switch * 1		Setting	
		TCP/IP	UDP/IP
Operation mode setting switch		0 (online)	0 (online)
Communications condition setting switches	Line processing selection for TCP time-out error	OFF	OFF
	Data code setting	ON (ASCII code)	OFF (binary code)
	CPU communications timing setting	ON	ON
	Initial timing setting	OFF	OFF

\*1: For switch numbers, refer to the E71 module manual.

6.2.2 Accessing procedure

The procedure for making access to the PLC CPU using Ethernet communication will be explained in the following order.

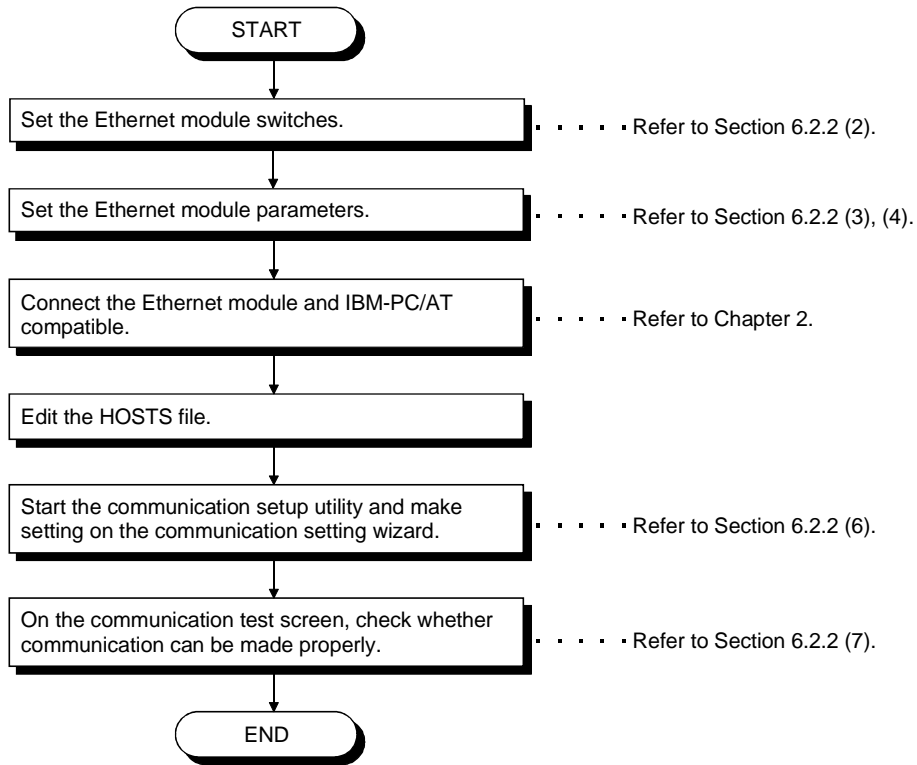

(1) System examples

The following system examples are used in this section.

The explanation given in "(6) Setting the logical station number (Setting on communication setting wizard)" and later uses the system example for Q series-compatible E71.

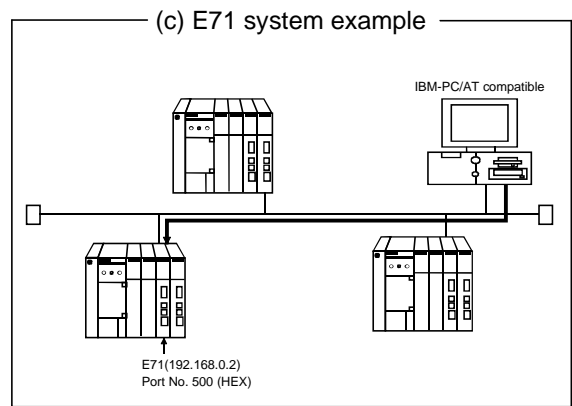
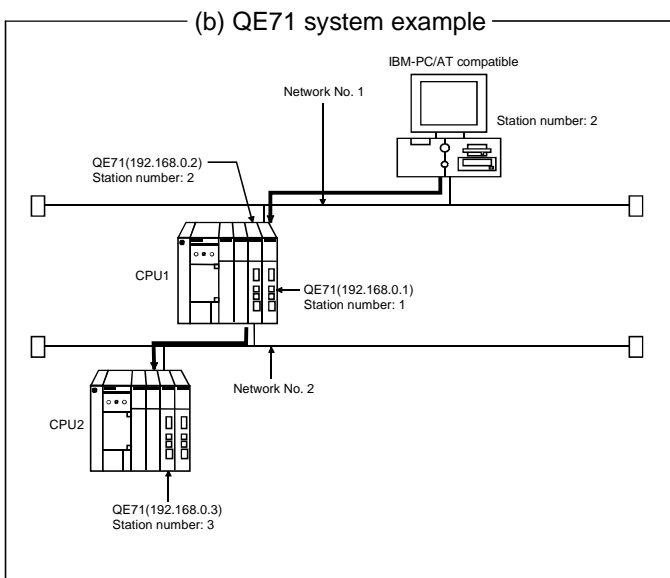
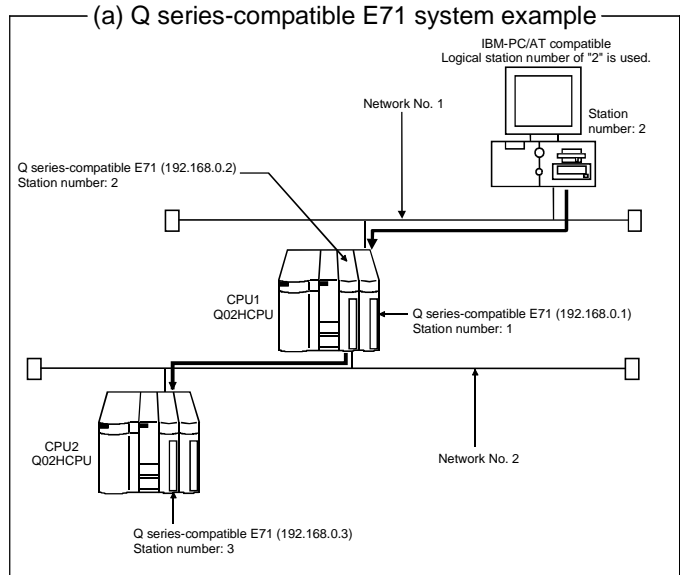

## (2) Making the switch settings of the Ethernet modules

## (a) Q series-compatible E71

Set the Q series-compatible E71 in "MNET/10H Ethernet module count setting" of GPPW.

## (b) QE71

Switch (Switch Number)		Setting	
		TCP/IP	UDP/IP
Operation mode setting switch		0 (online)	0 (online)
Communications condition setting switches	Line processing selection for TCP time-out error (SW1)	OFF	OFF
	Data code setting (SW2)	ON (ASCII code)	OFF (binary code)
	Automatic start mode setting (SW3)	OFF	ON
	— (SW4 to SW6)	All OFF	All OFF
	CPU communications timing setting (SW7)	ON	ON
Initial timing setting (SW8)		OFF	OFF

## (c) E71

Switch *1		Setting	
		TCP/IP	UDP/IP
Operation mode setting switch		0 (online)	0 (online)
Communications condition setting switches	Line processing selection for TCP time-out error	OFF	OFF
	Data code setting	ON (ASCII code)	OFF (binary code)
	CPU communications timing setting	ON	ON
	Initial timing setting	OFF	OFF

\*1: For switch numbers, refer to the E71 module manual.



(3) Making parameter setting

Parameter setting may either be made from the network parameter "MELSECNET/ETHERNET setting screen" of GPPW or from a sequence program.

The network parameters of GPPW must be used to set the Q series-compatible E71 (TCP/IP) or QE71 (UDP/IP), or a sequence program used to set the QE71 (TCP/IP) or E71 (TCP/IP, UDP/IP).

(a) Q series-compatible E71

In the network parameters, set the network type, first I/O No., network No., station number, mode and operational settings.

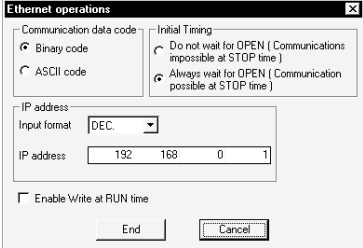
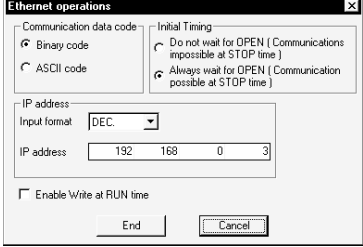
CPU to Be Set	Setting Screen Example																																																
CPU1	<p style="text-align: center;"><b>Ethernet parameters</b></p> <table border="1" style="width: 100%; border-collapse: collapse;"> <thead> <tr> <th></th> <th style="text-align: center;">Module 1</th> <th style="text-align: center;">Module 2</th> </tr> </thead> <tbody> <tr> <td>Network type</td> <td style="text-align: center;">Ethernet</td> <td style="text-align: center;">Ethernet</td> </tr> <tr> <td>Starting I/O No.</td> <td style="text-align: center;">0000</td> <td style="text-align: center;">0000</td> </tr> <tr> <td>Network No.</td> <td style="text-align: center;">2</td> <td style="text-align: center;">1</td> </tr> <tr> <td>Total stations</td> <td></td> <td></td> </tr> <tr> <td>Group No.</td> <td style="text-align: center;">0</td> <td style="text-align: center;">0</td> </tr> <tr> <td>Station No.</td> <td style="text-align: center;">2</td> <td style="text-align: center;">1</td> </tr> <tr> <td>Mode</td> <td style="text-align: center;">On line</td> <td style="text-align: center;">On line</td> </tr> <tr> <td></td> <td style="text-align: center;">Operational settings</td> <td style="text-align: center;">Operational settings</td> </tr> <tr> <td></td> <td style="text-align: center;">Initial settings</td> <td style="text-align: center;">Initial settings</td> </tr> <tr> <td></td> <td style="text-align: center;">Open settings</td> <td style="text-align: center;">Open settings</td> </tr> <tr> <td></td> <td style="text-align: center;">Routing information</td> <td style="text-align: center;">Routing information</td> </tr> <tr> <td></td> <td style="text-align: center;">MNET/110 routing information</td> <td style="text-align: center;">MNET/110 routing information</td> </tr> <tr> <td></td> <td style="text-align: center;">FTP Parameters</td> <td style="text-align: center;">FTP Parameters</td> </tr> <tr> <td></td> <td style="text-align: center;">E-mail settings</td> <td style="text-align: center;">E-mail settings</td> </tr> <tr> <td></td> <td style="text-align: center;">Interrupt settings</td> <td style="text-align: center;">Interrupt settings</td> </tr> </tbody> </table>		Module 1	Module 2	Network type	Ethernet	Ethernet	Starting I/O No.	0000	0000	Network No.	2	1	Total stations			Group No.	0	0	Station No.	2	1	Mode	On line	On line		Operational settings	Operational settings		Initial settings	Initial settings		Open settings	Open settings		Routing information	Routing information		MNET/110 routing information	MNET/110 routing information		FTP Parameters	FTP Parameters		E-mail settings	E-mail settings		Interrupt settings	Interrupt settings
		Module 1	Module 2																																														
Network type	Ethernet	Ethernet																																															
Starting I/O No.	0000	0000																																															
Network No.	2	1																																															
Total stations																																																	
Group No.	0	0																																															
Station No.	2	1																																															
Mode	On line	On line																																															
	Operational settings	Operational settings																																															
	Initial settings	Initial settings																																															
	Open settings	Open settings																																															
	Routing information	Routing information																																															
	MNET/110 routing information	MNET/110 routing information																																															
	FTP Parameters	FTP Parameters																																															
	E-mail settings	E-mail settings																																															
	Interrupt settings	Interrupt settings																																															
<p style="text-align: center;"><b>Operational settings</b></p> 																																																	
CPU2	<p style="text-align: center;"><b>Ethernet parameters</b></p> <table border="1" style="width: 100%; border-collapse: collapse;"> <thead> <tr> <th></th> <th style="text-align: center;">Module 1</th> <th style="text-align: center;">Module 2</th> </tr> </thead> <tbody> <tr> <td>Network type</td> <td style="text-align: center;">Ethernet</td> <td style="text-align: center;">None</td> </tr> <tr> <td>Starting I/O No.</td> <td style="text-align: center;">0000</td> <td></td> </tr> <tr> <td>Network No.</td> <td style="text-align: center;">2</td> <td></td> </tr> <tr> <td>Total stations</td> <td></td> <td></td> </tr> <tr> <td>Group No.</td> <td style="text-align: center;">0</td> <td></td> </tr> <tr> <td>Station No.</td> <td style="text-align: center;">3</td> <td></td> </tr> <tr> <td>Mode</td> <td style="text-align: center;">On line</td> <td></td> </tr> <tr> <td></td> <td style="text-align: center;">Operational settings</td> <td></td> </tr> <tr> <td></td> <td style="text-align: center;">Initial settings</td> <td></td> </tr> <tr> <td></td> <td style="text-align: center;">Open settings</td> <td></td> </tr> <tr> <td></td> <td style="text-align: center;">Routing information</td> <td></td> </tr> <tr> <td></td> <td style="text-align: center;">MNET/110 routing information</td> <td></td> </tr> <tr> <td></td> <td style="text-align: center;">FTP Parameters</td> <td></td> </tr> <tr> <td></td> <td style="text-align: center;">E-mail settings</td> <td></td> </tr> <tr> <td></td> <td style="text-align: center;">Interrupt settings</td> <td></td> </tr> </tbody> </table>		Module 1	Module 2	Network type	Ethernet	None	Starting I/O No.	0000		Network No.	2		Total stations			Group No.	0		Station No.	3		Mode	On line			Operational settings			Initial settings			Open settings			Routing information			MNET/110 routing information			FTP Parameters			E-mail settings			Interrupt settings	
		Module 1	Module 2																																														
Network type	Ethernet	None																																															
Starting I/O No.	0000																																																
Network No.	2																																																
Total stations																																																	
Group No.	0																																																
Station No.	3																																																
Mode	On line																																																
	Operational settings																																																
	Initial settings																																																
	Open settings																																																
	Routing information																																																
	MNET/110 routing information																																																
	FTP Parameters																																																
	E-mail settings																																																
	Interrupt settings																																																
<p style="text-align: center;"><b>Operational settings</b></p> 																																																	

(b) QE71  
1) For TCP/IP

The QE71 requires an initial processing and communication line open processing sequence program for use of TCP/IP.

The sequence program example is given below.

Setting Item	Set Value
TCP/IP open system	8000H (TCP, fixed buffer send)
QE71's IP address	192.168.0.2

Setting Item	Set Value
QE71's port number	500H

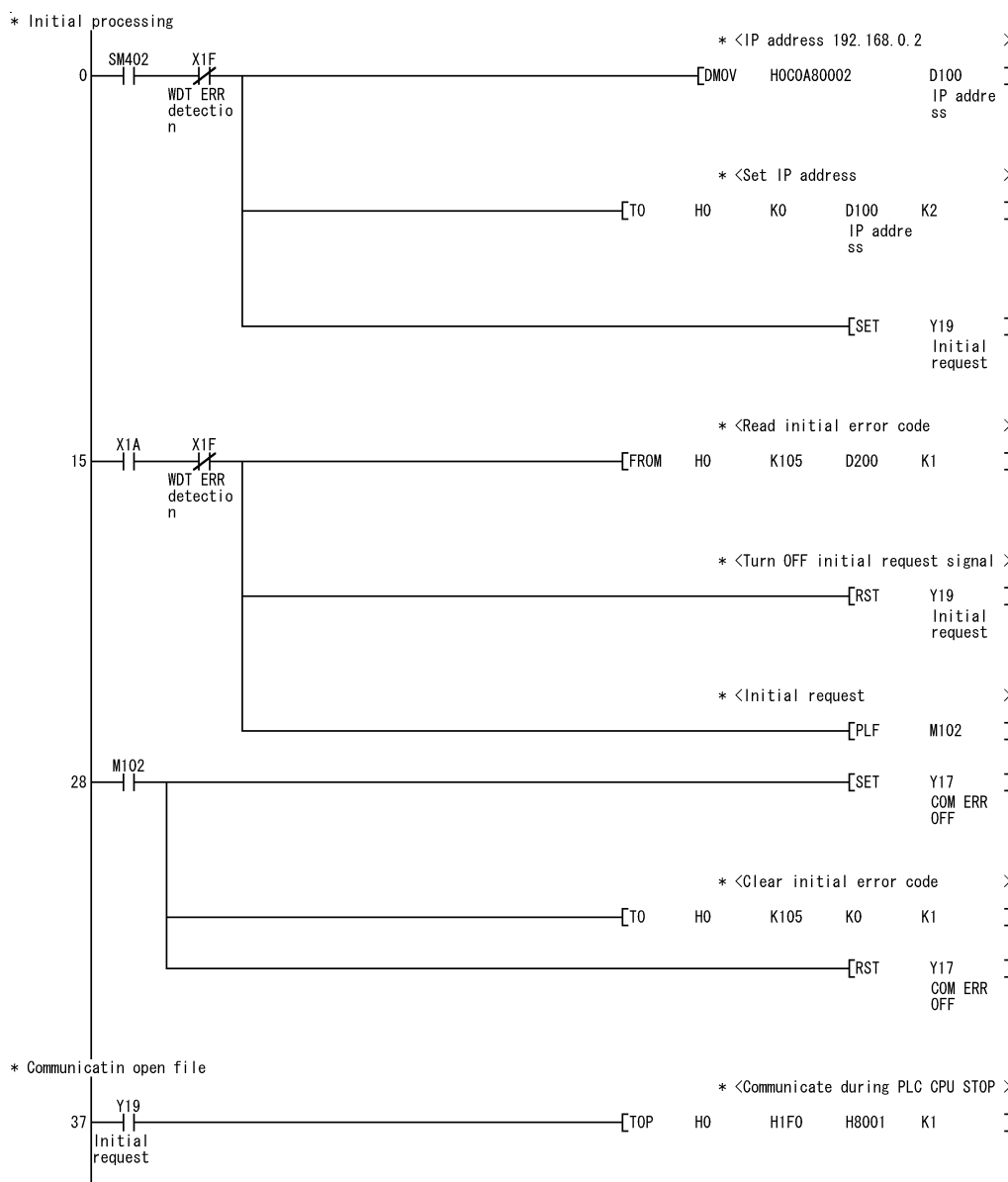

↓  
(To the next page)

(From the preceding page)

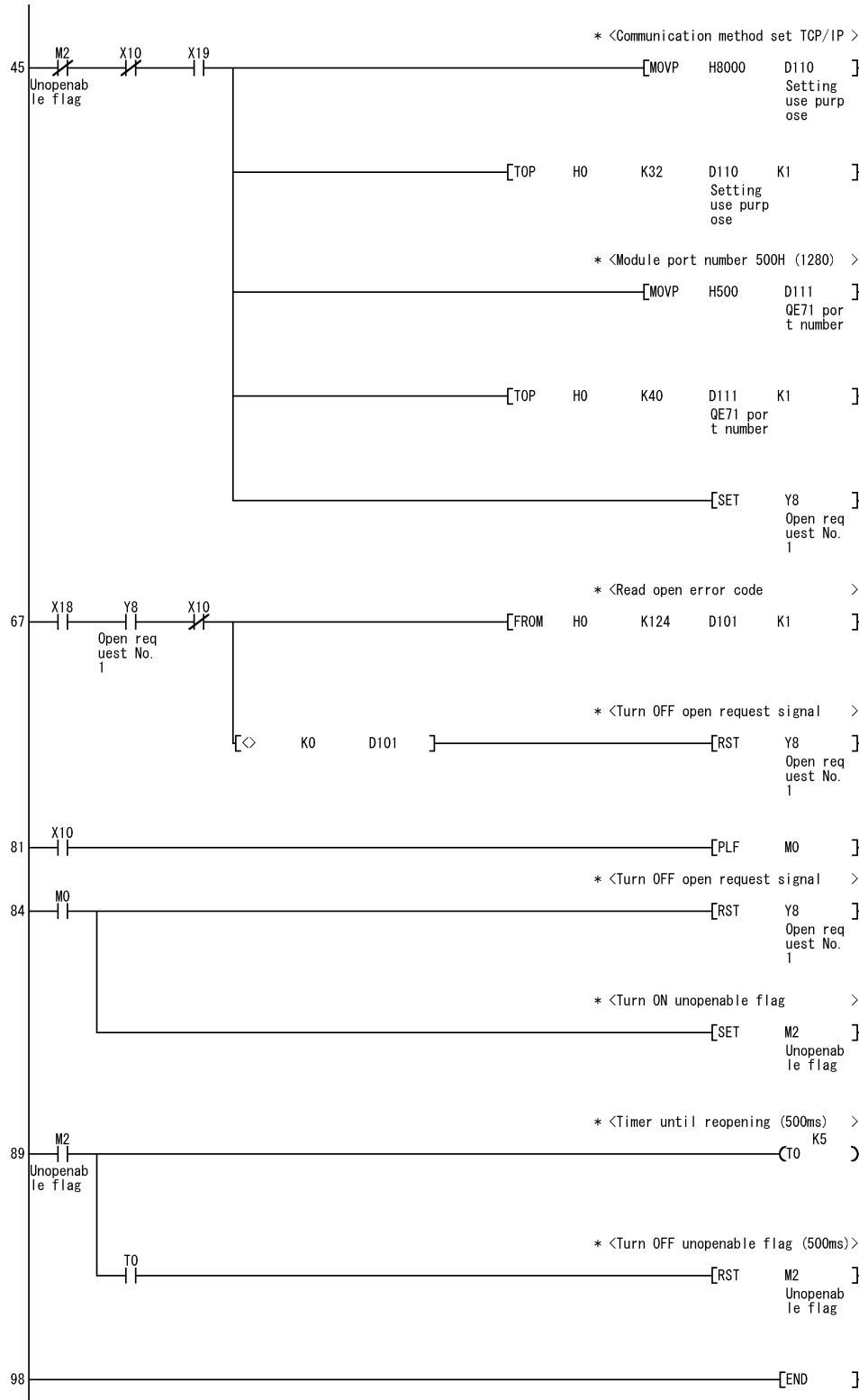

2) For UDP/IP

For the QE71, set the network type, first I/O No., network No., group No., station number and IP address on the Ethernet parameter setting screen of GPPW when using UDP/IP.

CPU to Be Set	Setting Screen Example																																	
<p style="text-align: center;">CPU1</p>	<p style="text-align: center;"><b>Ethernet parameters</b></p> <table border="1" style="width: 100%; border-collapse: collapse;"> <thead> <tr> <th></th> <th style="text-align: center;">Module No.1</th> <th style="text-align: center;">Module No.2</th> </tr> </thead> <tbody> <tr> <td>Network type</td> <td style="text-align: center;">Ethernet</td> <td style="text-align: center;">Ethernet</td> </tr> <tr> <td>Start I/O No.</td> <td style="text-align: center;">0040</td> <td style="text-align: center;">0060</td> </tr> <tr> <td>Network No.</td> <td style="text-align: center;">2</td> <td style="text-align: center;">1</td> </tr> <tr> <td>Total stations</td> <td></td> <td></td> </tr> <tr> <td>Group No.</td> <td style="text-align: center;">0</td> <td style="text-align: center;">0</td> </tr> <tr> <td>Station No.</td> <td style="text-align: center;">2</td> <td style="text-align: center;">1</td> </tr> <tr> <td>IP address/DEC</td> <td style="text-align: center;">192.168.0.2</td> <td style="text-align: center;">192.168.0.1</td> </tr> <tr> <td></td> <td style="text-align: center;"><small>MNE I/O routing information</small></td> <td style="text-align: center;"><small>MNE I/O routing information</small></td> </tr> <tr> <td></td> <td style="text-align: center;"><small>FTP Parameters</small></td> <td style="text-align: center;"><small>FTP Parameters</small></td> </tr> <tr> <td></td> <td style="text-align: center;"><small>Routing information</small></td> <td style="text-align: center;"><small>Routing information</small></td> </tr> </tbody> </table>		Module No.1	Module No.2	Network type	Ethernet	Ethernet	Start I/O No.	0040	0060	Network No.	2	1	Total stations			Group No.	0	0	Station No.	2	1	IP address/DEC	192.168.0.2	192.168.0.1		<small>MNE I/O routing information</small>	<small>MNE I/O routing information</small>		<small>FTP Parameters</small>	<small>FTP Parameters</small>		<small>Routing information</small>	<small>Routing information</small>
		Module No.1	Module No.2																															
Network type	Ethernet	Ethernet																																
Start I/O No.	0040	0060																																
Network No.	2	1																																
Total stations																																		
Group No.	0	0																																
Station No.	2	1																																
IP address/DEC	192.168.0.2	192.168.0.1																																
	<small>MNE I/O routing information</small>	<small>MNE I/O routing information</small>																																
	<small>FTP Parameters</small>	<small>FTP Parameters</small>																																
	<small>Routing information</small>	<small>Routing information</small>																																
<p style="text-align: center;"><b>Operational settings</b></p> <div style="border: 1px solid black; padding: 5px; width: fit-content; margin: auto;"> <p><b>IP Address</b> <span style="float: right;">✕</span></p> <p>Input format: DEC. ▾</p> <p>IP address: <input style="width: 40px;" type="text" value="192"/> <input style="width: 40px;" type="text" value="168"/> <input style="width: 40px;" type="text" value="0"/> <input style="width: 40px;" type="text" value="2"/></p> <p style="text-align: center;"> <input type="button" value="OK"/> <input type="button" value="Cancel"/> </p> </div>																																		
<p style="text-align: center;">CPU2</p>	<p style="text-align: center;"><b>Ethernet parameters</b></p> <table border="1" style="width: 100%; border-collapse: collapse;"> <thead> <tr> <th></th> <th style="text-align: center;">Module No.1</th> <th style="text-align: center;">Module No.2</th> </tr> </thead> <tbody> <tr> <td>Network type</td> <td style="text-align: center;">Ethernet</td> <td style="text-align: center;">None</td> </tr> <tr> <td>Start I/O No.</td> <td style="text-align: center;">0040</td> <td></td> </tr> <tr> <td>Network No.</td> <td style="text-align: center;">2</td> <td></td> </tr> <tr> <td>Total stations</td> <td></td> <td></td> </tr> <tr> <td>Group No.</td> <td style="text-align: center;">0</td> <td></td> </tr> <tr> <td>Station No.</td> <td style="text-align: center;">3</td> <td></td> </tr> <tr> <td>IP address/DEC</td> <td style="text-align: center;">192.168.0.3</td> <td></td> </tr> <tr> <td></td> <td style="text-align: center;"><small>MNE I/O routing information</small></td> <td></td> </tr> <tr> <td></td> <td style="text-align: center;"><small>FTP Parameters</small></td> <td></td> </tr> <tr> <td></td> <td style="text-align: center;"><small>Routing information</small></td> <td></td> </tr> </tbody> </table>		Module No.1	Module No.2	Network type	Ethernet	None	Start I/O No.	0040		Network No.	2		Total stations			Group No.	0		Station No.	3		IP address/DEC	192.168.0.3			<small>MNE I/O routing information</small>			<small>FTP Parameters</small>			<small>Routing information</small>	
		Module No.1	Module No.2																															
Network type	Ethernet	None																																
Start I/O No.	0040																																	
Network No.	2																																	
Total stations																																		
Group No.	0																																	
Station No.	3																																	
IP address/DEC	192.168.0.3																																	
	<small>MNE I/O routing information</small>																																	
	<small>FTP Parameters</small>																																	
	<small>Routing information</small>																																	
<p style="text-align: center;"><b>Operational settings</b></p> <div style="border: 1px solid black; padding: 5px; width: fit-content; margin: auto;"> <p><b>IP Address</b> <span style="float: right;">✕</span></p> <p>Input format: DEC. ▾</p> <p>IP address: <input style="width: 40px;" type="text" value="192"/> <input style="width: 40px;" type="text" value="168"/> <input style="width: 40px;" type="text" value="0"/> <input style="width: 40px;" type="text" value="3"/></p> <p style="text-align: center;"> <input type="button" value="OK"/> <input type="button" value="Cancel"/> </p> </div>																																		

(c) E71

The E71 requires an initial processing and communication line open processing sequence program.

The sequence program example is given below.

1) For TCP/IP

Setting Item	Set Value
TCP/IP open system	8000H (TCP, fixed buffer send)
E71's IP address	192.168.0.2

Setting Item	Set Value
E71's port number	500H

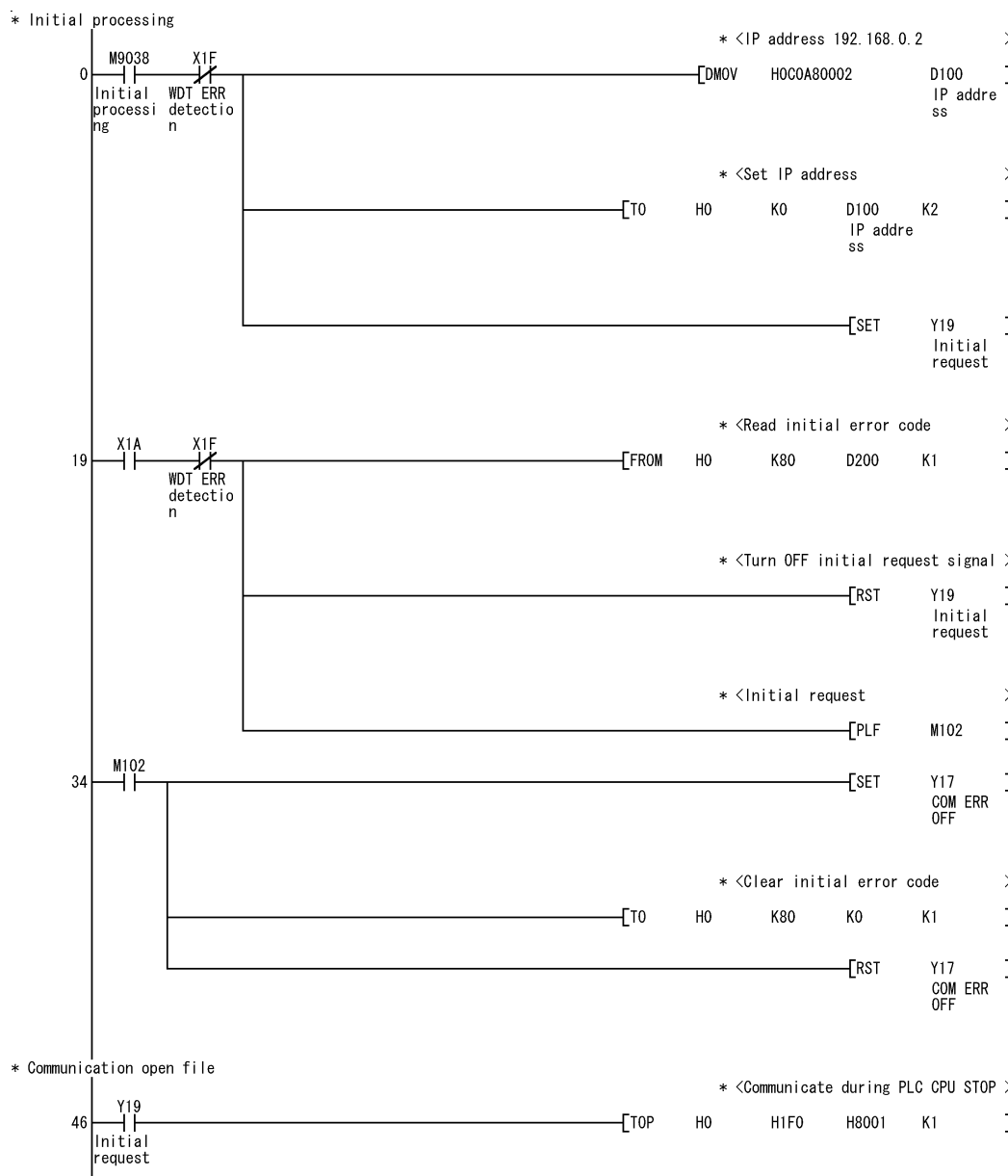

↓  
(To the next page)

(From the preceding page)

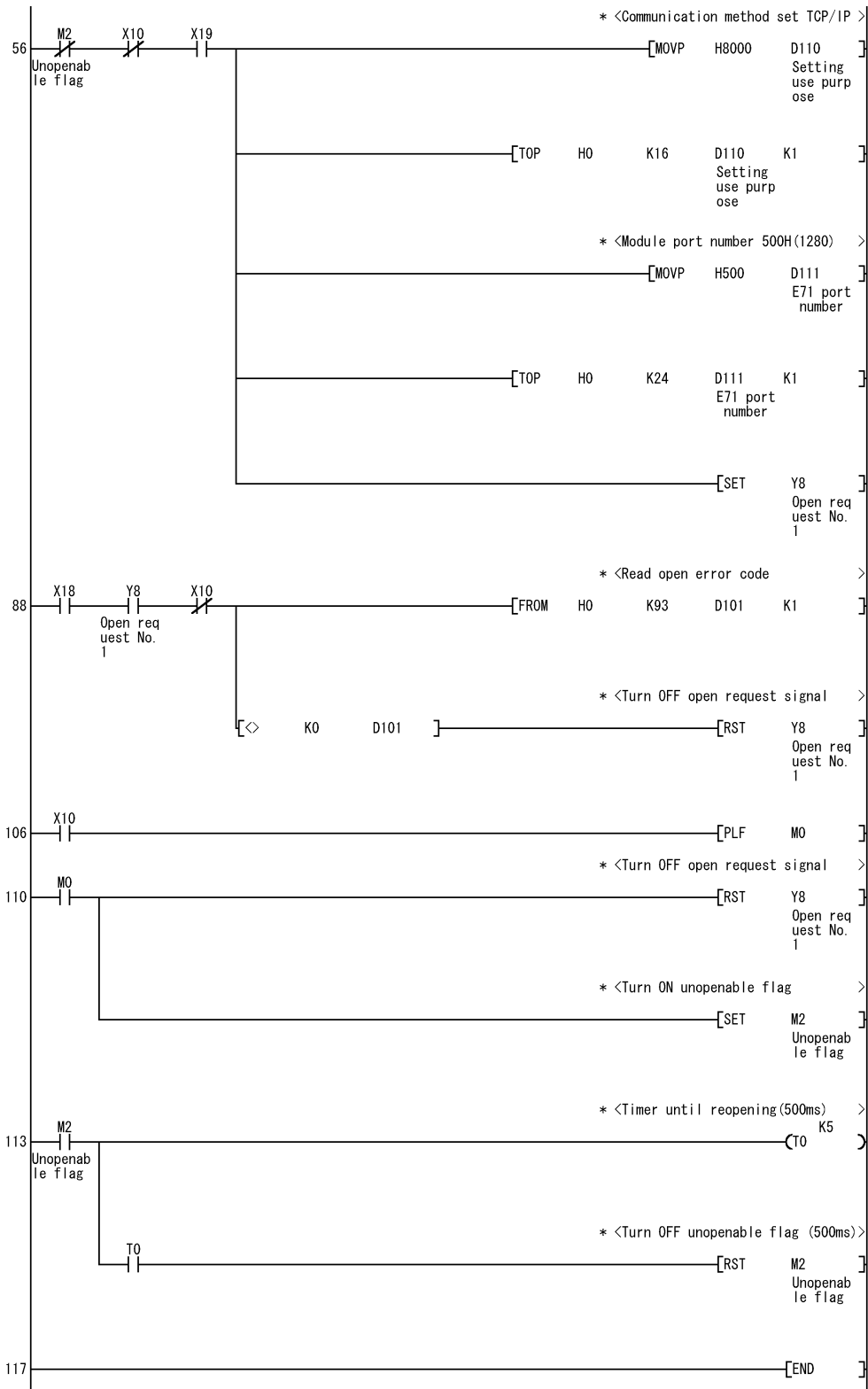

2) For UDP/IP

Setting Item	Set Value
UDP/IP open system	100H (UDP, fixed buffer send)
E71's IP address	192.168.0.2
E71's port number	500H

Setting Item	Set Value
Other node IP address	FFFFFFF
Other node port number	FFFF

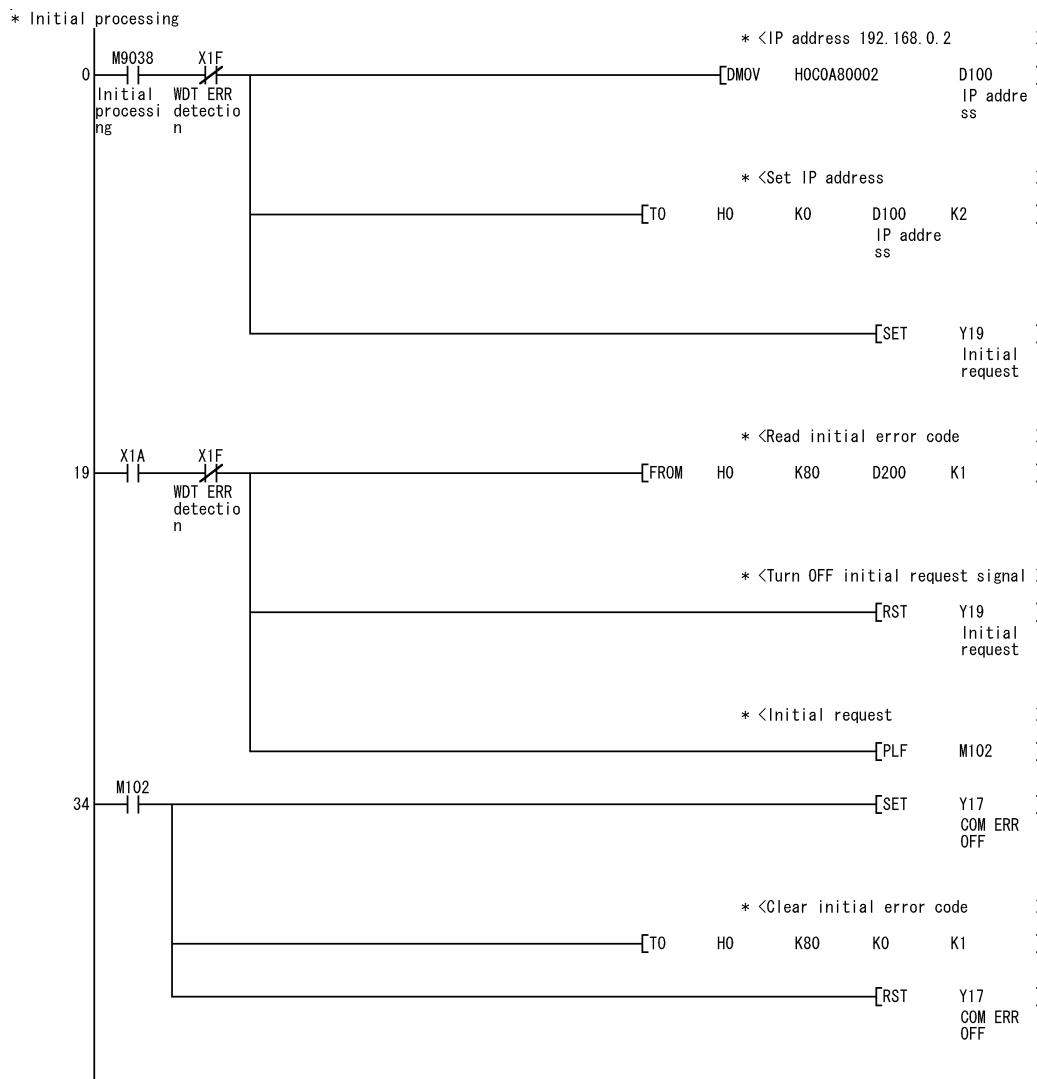

↓  
(To the next page)

(From the preceding page)

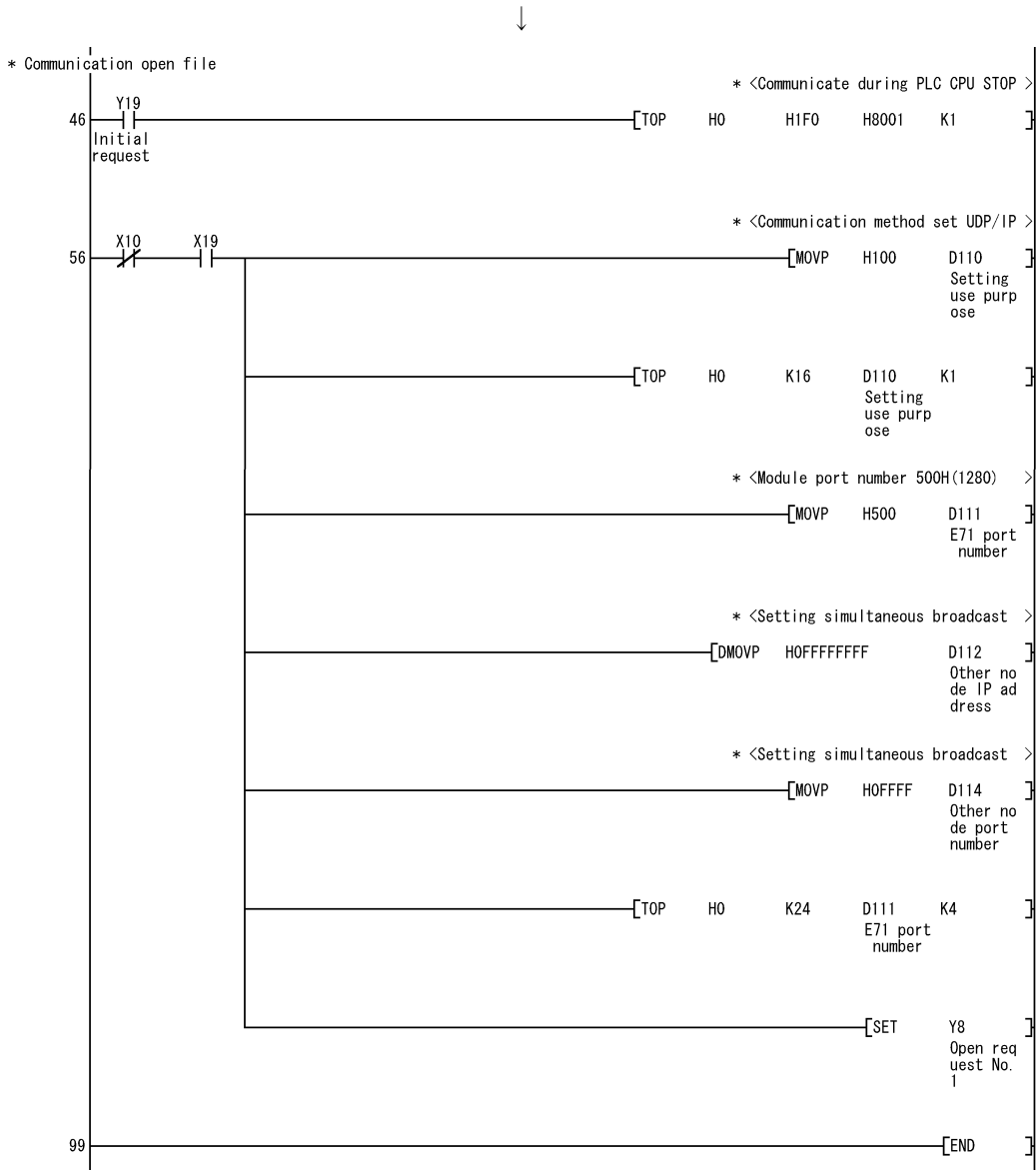

In the communications enabled status, the E71's RUN LED is lit and the RDY LED flickers.



## (4) Making routing parameter setting

## (a) Q series-compatible E71

Set the routing parameters on the Ethernet parameter setting screen of GPPW.  
For the concept of the routing parameters, refer to "Appendix 1 Concept of Routing Parameters".

CPU to Be Set	Setting Screen Example				
CPU1		Target networkNo.	Relay networkNo.	Relay StationNo.	Via StationNo.
	1	1	2	2	
	2	2	1	1	
	3				
CPU2		Target networkNo.	Relay networkNo.	Relay StationNo.	Via StationNo.
	1	1	2	2	
	2				

## (b) QE71

Set the routing parameters on the Ethernet parameter setting screen of GPPW.  
For the concept of the routing parameters, refer to "Appendix 1 Concept of Routing Parameters".

CPU to Be Set	Setting Screen Example				
CPU1		Target networkNo.	Relay networkNo.	Relay StationNo.	Via StationNo.
	1	1	2	2	
	2	2	1	1	
	3				
CPU2		Target networkNo.	Relay networkNo.	Relay StationNo.	Via StationNo.
	1	1	2	2	
	2				

## (5) Making communications check

After completion of preparations for Ethernet communication, execute ping in the MS-DOS mode to check connection before starting communications on ACT.

When normal

```
C:\>ping 192.168.0.2
```

```
Reply from 192.168.0.2:bytes=32 time<10ms TTL=32
```

When abnormal

```
C:\>ping 192.168.0.2
```

```
Request timed out.
```

If ping does not pass through, check module connections and Windows side IP address and other settings.

## (6) Setting the logical station number (Setting on communication setting wizard)

Logical station number setting will be described using the system example for Q series-compatible E71.

1) Start the communication setup utility and choose the communication setting wizard.

2) Type "2" in Logical station number and click the **Next>** button.

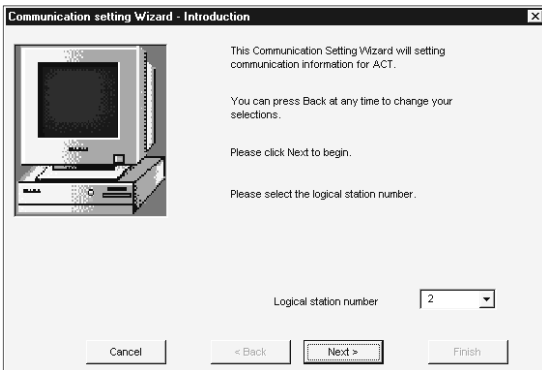

3) Make settings as indicated below and click the **Next>** button.

PC side I/F : Ethernet board  
 Protocol : TCP  
 Network No. : 1  
 Station No. : 2  
 Time out : 10000

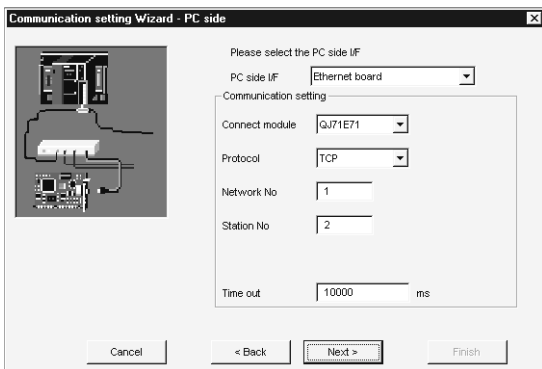

4) Make settings as indicated below and click the **Next>** button.

PLC side I/F : Ethernet unit  
 Module type : QJ71E71  
 Host : 192.168.0.1  
 Station No. : 1

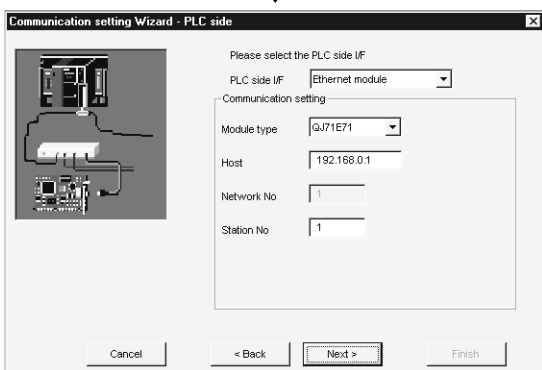

(To the next page)

(From the preceding page)

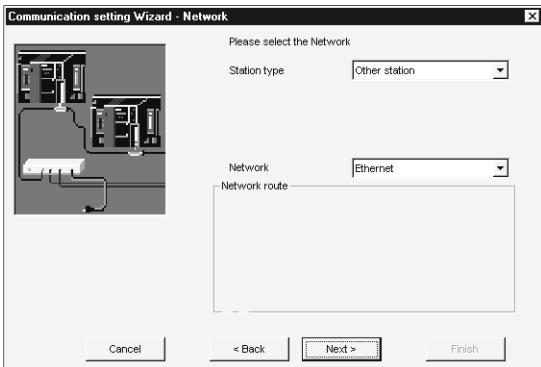

5) Make settings as indicated below and click the **Next>** button.

Station type : Other station  
Network : Ethernet

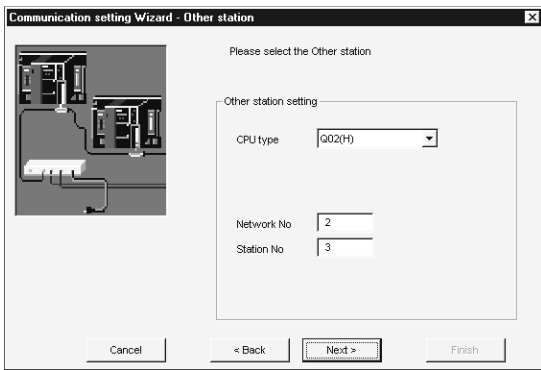

6) Make settings as indicated below and click the **Next>** button.

CPU type : Q02(H)  
Network No. : 2  
Station No. : 3

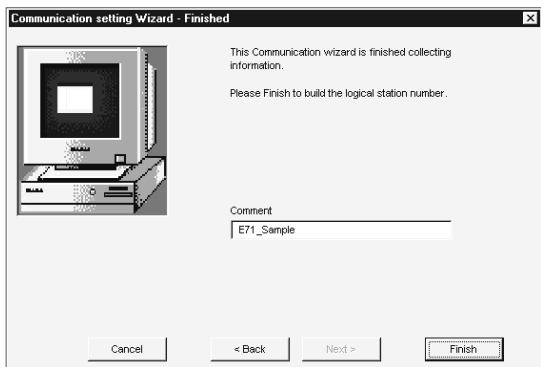

7) Enter a comment and click the **Finish** button.

(Registration complete)

(7) Checking the logical station number settings (Conducting a communication test)

Using the logical station number set in (6), check whether the computer link communication settings are correct or not.

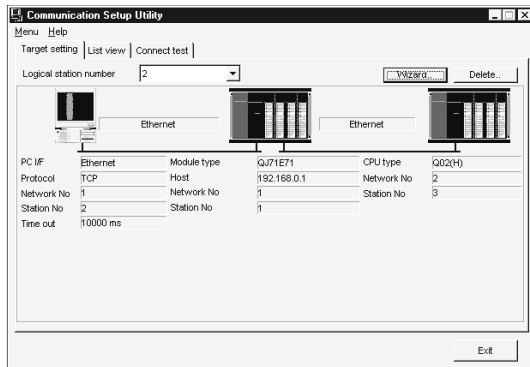

- 1) Display the target setting screen and choose the logical station number "2".  
Check whether the logical station number settings are correct or not.

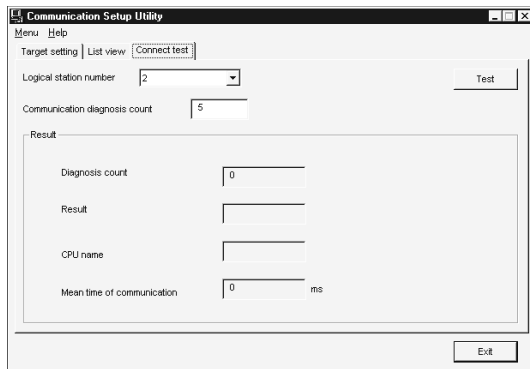

- 2) Show the connection test screen and set the logical station number "2".

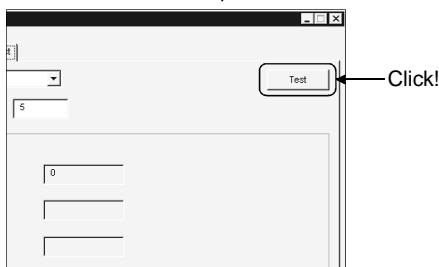

- 3) Click the **Test** button to check that communication is being made properly.  
If an error occurred, check the error code and remove the error. The error code appears in Result. (At normal termination, "0x00000000" appears in Result.)  
Refer to the programming manual for error code details.

(Communication test complete)

- 4) Through the above steps, you could confirm that the logical station number settings were correct.  
Using the set logical station number, you can create user programs and collect device information using the PLC monitor utility.

### 6.3 CPU COM Communication

This section provides the CPU COM communication procedure and its setting example using the utility setting type.

#### 6.3.1 Accessing procedure

The procedure for making access to the PLC CPU using CPU COM communication will be explained in the following order.

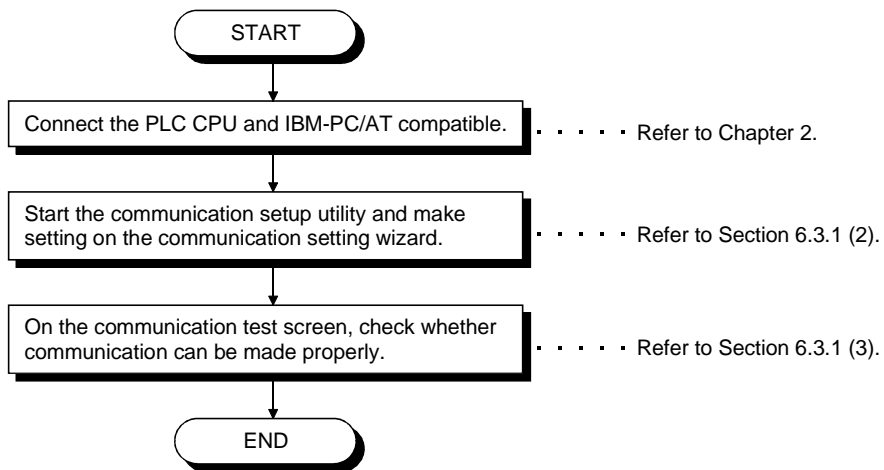

#### (1) System example

The following system example is used in this section.

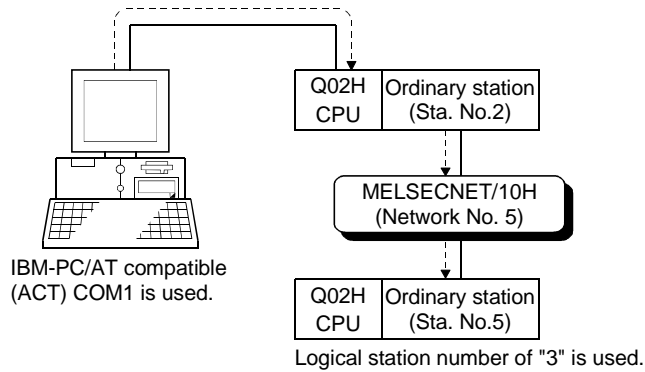

(2) Setting the logical station number (Setting on communication setting wizard)

Logical station number setting will be described using the system example for (1).

1) Start the communication setup utility and choose the communication setting wizard.

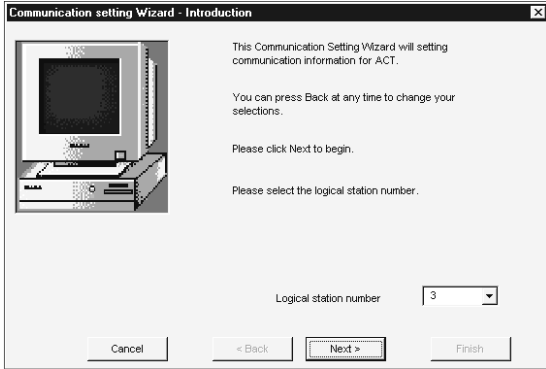

2) Type "3" in Logical station number and click the **Next>** button.

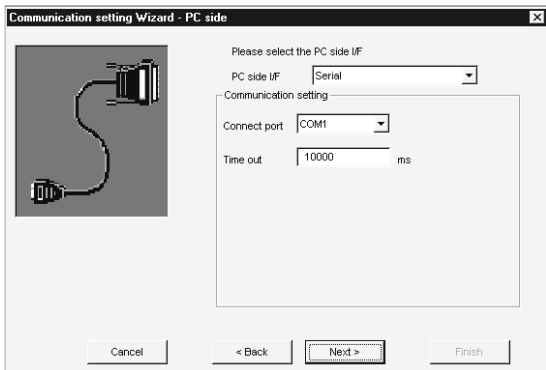

3) Make settings as indicated below and click the **Next>** button.

PC side I/F : Serial  
 Connect port : COM1  
 Time out : 10000

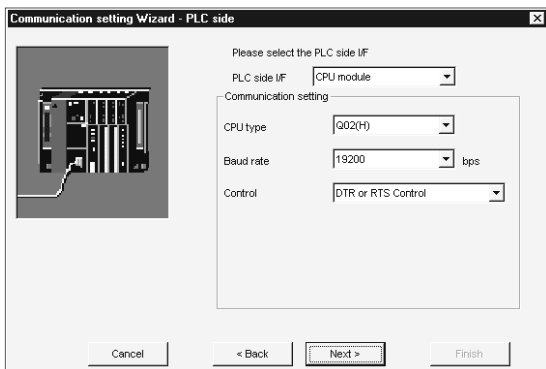

4) Make settings as indicated below and click the **Next>** button.

PLC side I/F : CPU module  
 CPU type : Q02(H)  
 Baud rate : 19200  
 Control : DTR or RTS Control



(To the next page)

(From the preceding page)

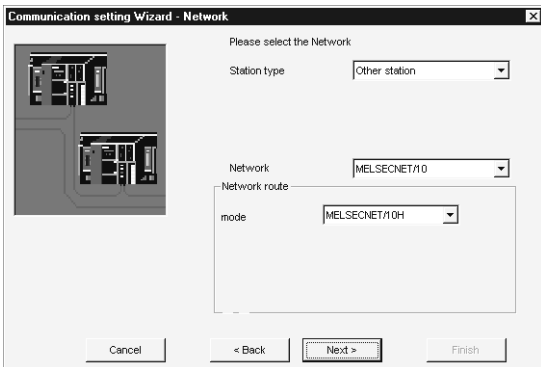

5) Make settings as indicated below and click the **Next>** button.

Station type : Other station  
 Network : MELSECNET/10  
 Mode : MELSECNET/10H

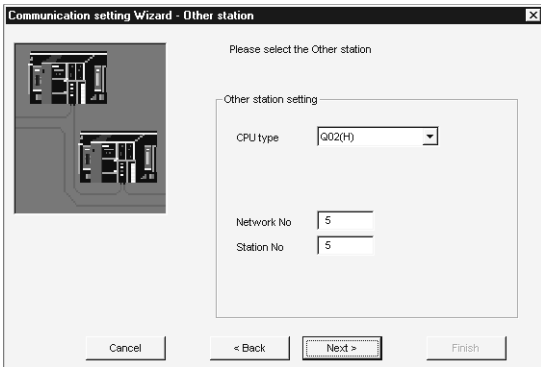

6) Make settings as indicated below and click the **Next>** button.

CPU type : Q02(H)  
 Network No. : 5  
 Station No. : 5

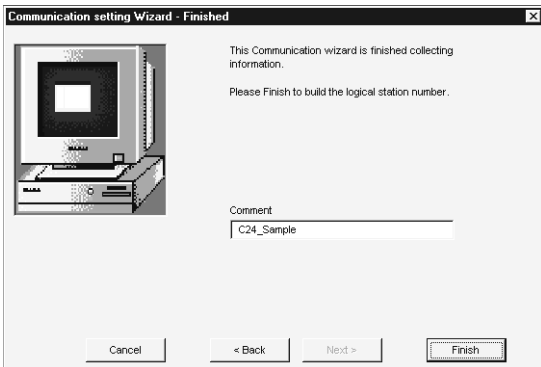

7) Enter a comment and click the **Finish** button.

(Registration complete)

(3) Checking the logical station number settings (Conducting a communication test)

Using the logical station number set in (2), check whether the CPU COM communication settings are correct or not.

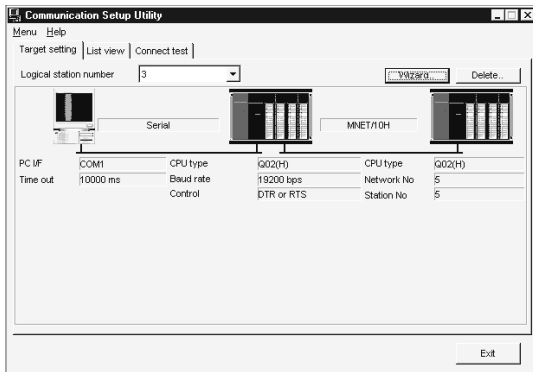

- 1) Display the target setting screen and choose the logical station number "3".  
Check whether the logical station number settings are correct or not.

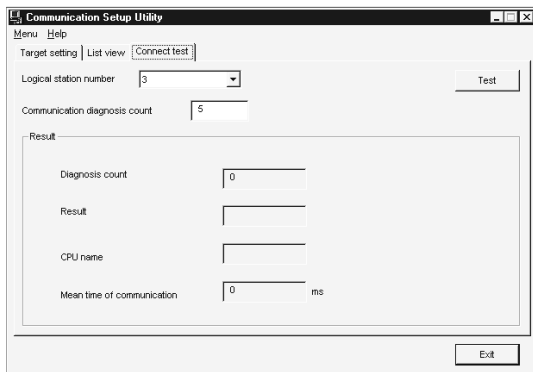

- 2) Show the connection test screen and set the logical station number "3".



- 3) Click the **Test** button to check that communication is being made properly.  
If an error occurred, check the error code and remove the error. The error code appears in Result. (At normal termination, "0x00000000" appears in Result.)  
Refer to the programming manual for error code details.

(Communication test complete)

- 4) Through the above steps, you could confirm that the logical station number settings were correct.  
Using the set logical station number, you can create user programs and collect device information using the PLC monitor utility.



### 6.4 CPU USB Communication

This section provides the CPU USB communication procedure and its setting example using the utility setting type.

#### 6.4.1 Accessing procedure

The procedure for making access to the PLC CPU using CPU USB communication will be explained in the following order.

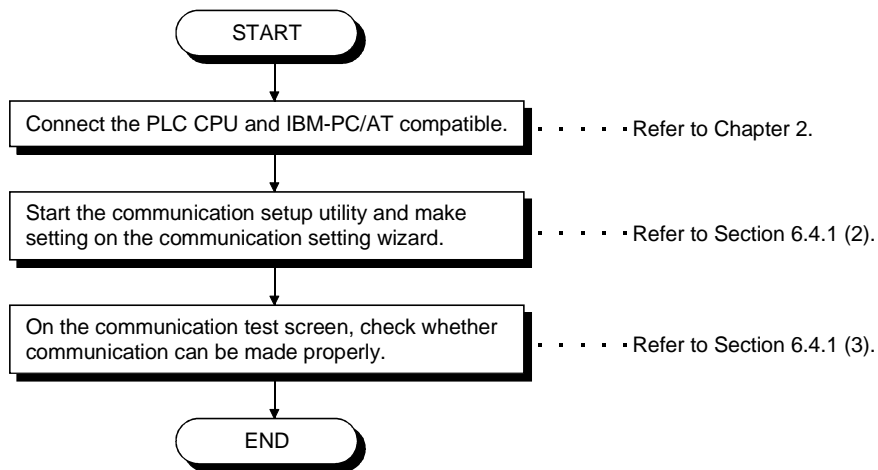

#### (1) System example

The following system example is used in this section.

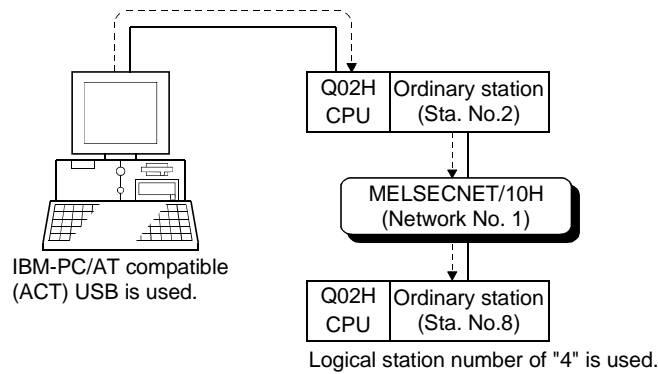

(2) Setting the logical station number (Setting on communication setting wizard)

Logical station number setting will be described using the system example for (1).

1) Start the communication setup utility and choose the communication setting wizard.

2) Type "4" in Logical station number and click the **Next>** button.

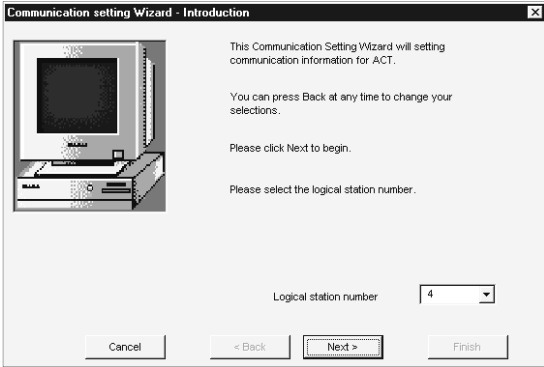

3) Make settings as indicated below and click the **Next>** button.

PC side I/F : Serial  
 Connect port : USB  
 Time out : 10000

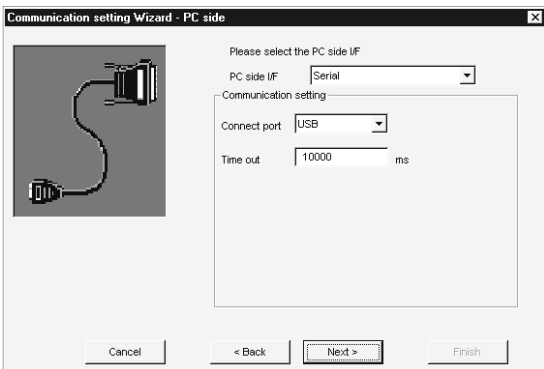

4) Make settings as indicated below and click the **Next>** button.

PLC side I/F : CPU module  
 Cpu type : Q02(H)

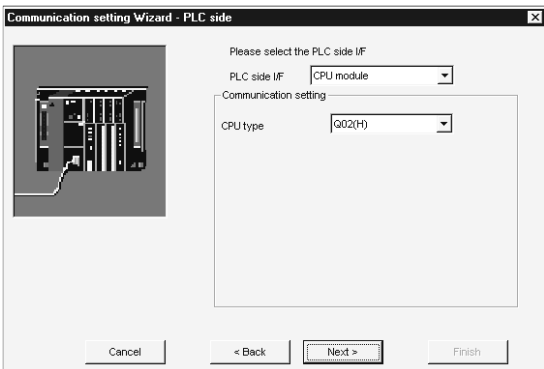

(To the next page)

(From the preceding page)

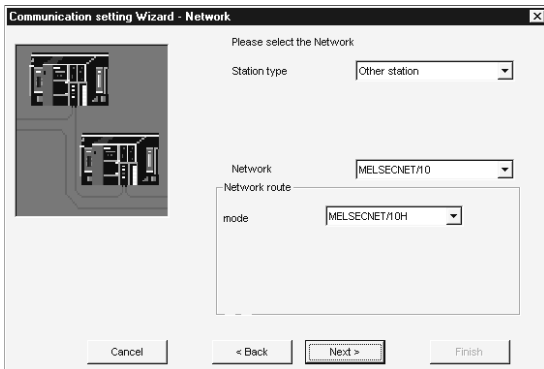

5) Make settings as indicated below and click the **Next>** button.

Station type : Other station  
Network : MELSECNET/10  
Mode : MELSECNET/10H

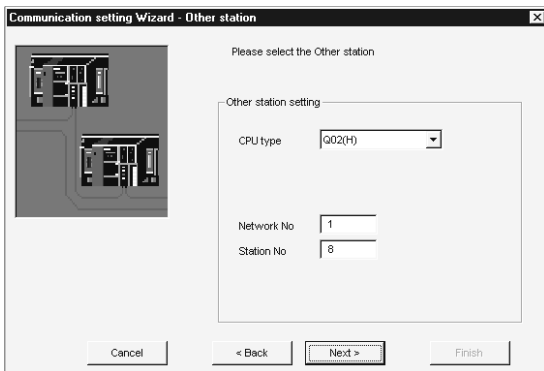

6) Make settings as indicated below and click the **Next>** button.

CPU type : Q02(H)  
Network No. : 1  
Station No. : 8

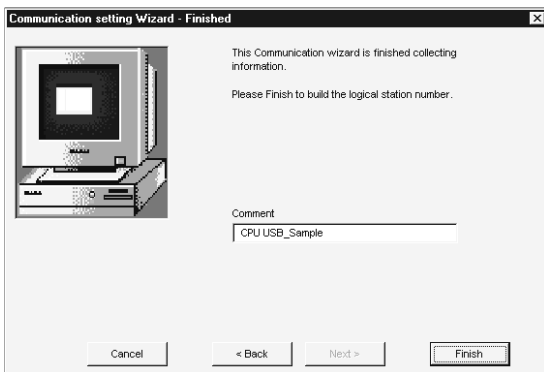

7) Enter a comment and click the **Finish** button.

(Registration complete)

(3) Checking the logical station number settings (Conducting a communication test)

Using the logical station number set in (2), check whether the CPU USB communication settings are correct or not.

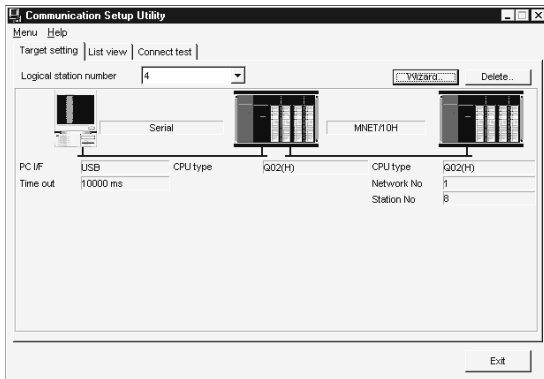

- 1) Display the target setting screen and choose the logical station number "4".  
Check whether the logical station number settings are correct or not.

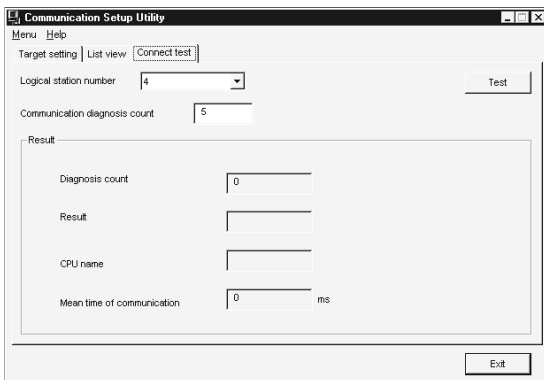

- 2) Show the connection test screen and set the logical station number "4".

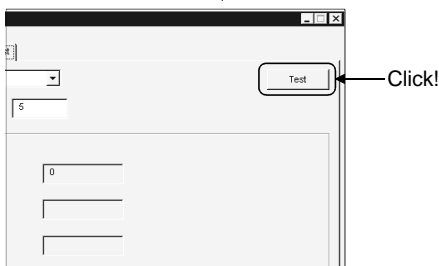

- 3) Click the **Test** button to check that communication is being made properly.  
If an error occurred, check the error code and remove the error. The error code appears in Result. (At normal termination, "0x00000000" appears in Result.)  
Refer to the programming manual for error code details.



(Communication test complete)

- 4) Through the above steps, you could confirm that the logical station number settings were correct.  
Using the set logical station number, you can create user programs and collect device information using the PLC monitor utility.

### 6.5 MELSECNET/10 Communication

This section provides the MELSECNET/10 communication procedure and its setting example using the utility setting type.

#### 6.5.1 Accessing procedure

The procedure for making access to the PLC CPU using MELSECNET/10 communication will be explained in the following order.

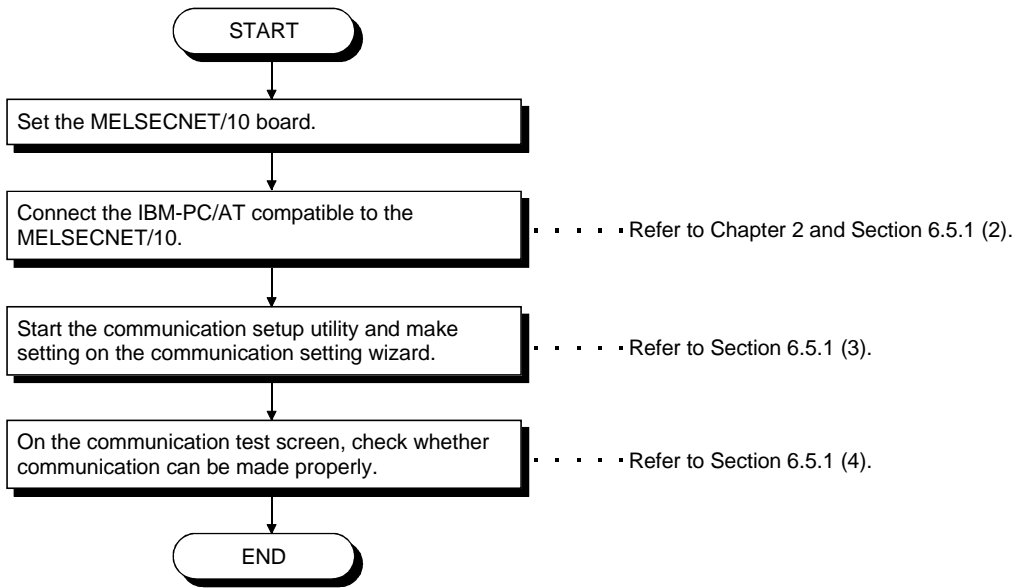

#### (1) System example

The following system example is used in this section.

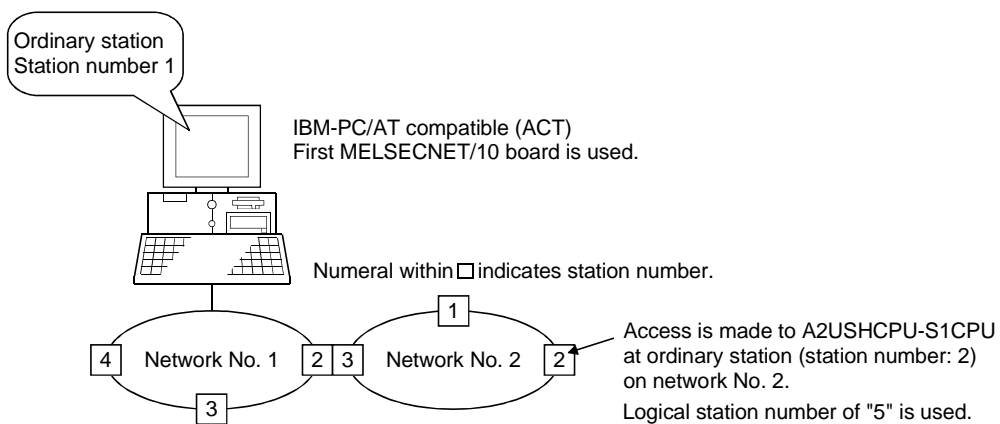

(2) Checking the MELSECNET/10 board

Check whether the IBM-PC/AT compatible is connected properly to the MELSECNET/10.

1) Click [Start]-[Programs]-[Melsec application]-[Communication support (CSKP-E)]-[MELSECNET10 Utility] to start the MELSECNET/10 utility.

2) Click the "Card information" tab and set the channel to "51:MELSECNET10 (1 slot)".  
After that, set the mode to "On-line automatic return" and click the **Routing Param. Setting** button.

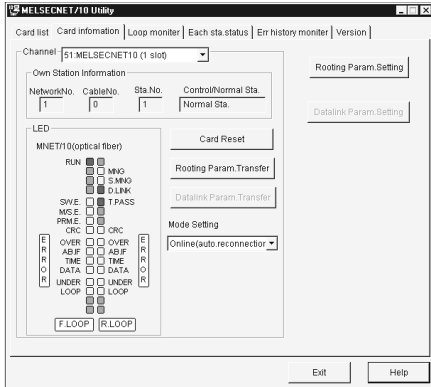

3) Set the routing parameters and click the **Set** button.

Target network No. : 2  
Relay target network No. : 1  
Relay target Sta. No. : 2

After that, click the **OK** button to close the dialog box.

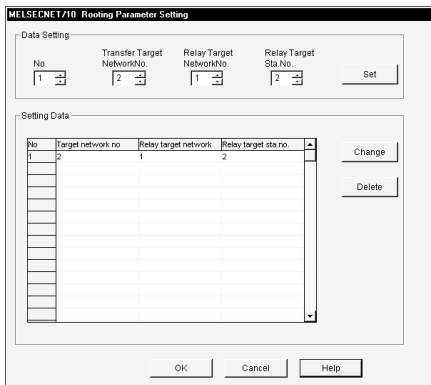

4) Click the **Routing Param. Transfer** button to transfer the routing parameters to the MELSECNET/10 card.

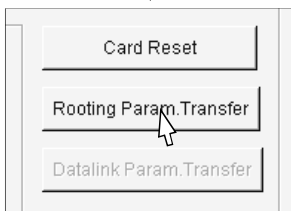

(To the next page)

(From the preceding page)

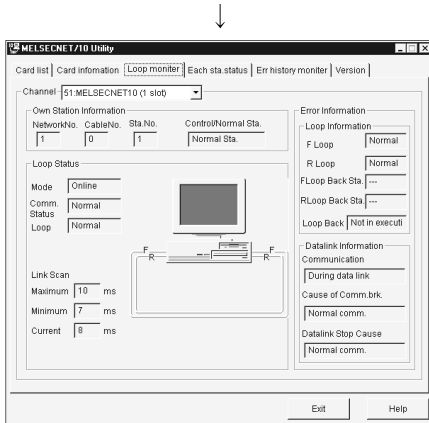

5) Click the "Loop monitor" tab and make sure that the loop is normal.

(Check complete)

6) Click the **Exit** button to exit from the utility.

**(3) Setting the logical station number (Setting on communication setting wizard)**

Logical station number setting will be described using the system example for (1).

1) Start the communication setup utility and choose the communication setting wizard.

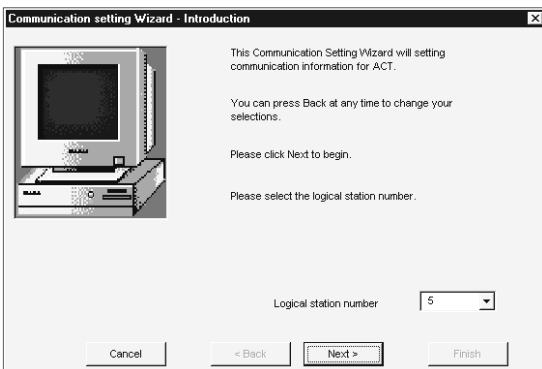

2) Type "5" in Logical station number and click the **Next>** button.

3) Make settings as indicated below and click the **Next>** button.

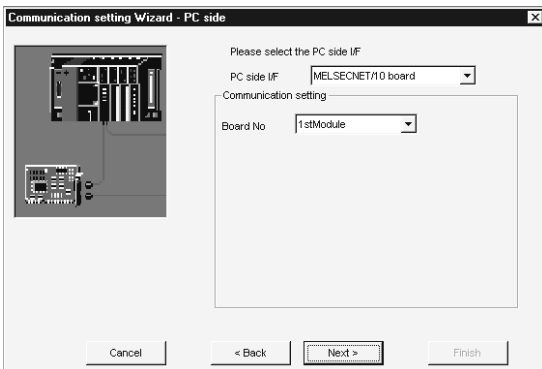

PC side I/F : MELSECNET/10 board  
Board No : 1stModule

(To the next page)

(From the preceding page)

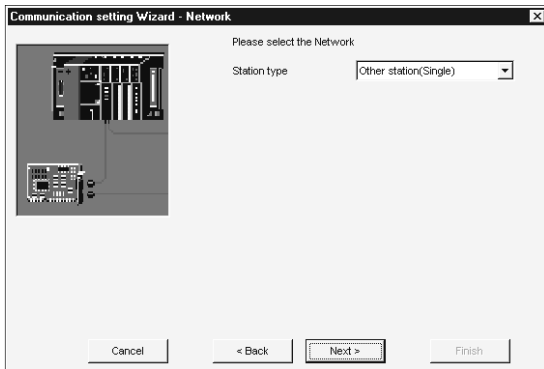

4) Make settings as indicated below and click the **Next>** button.

Station type : Other station(Single)

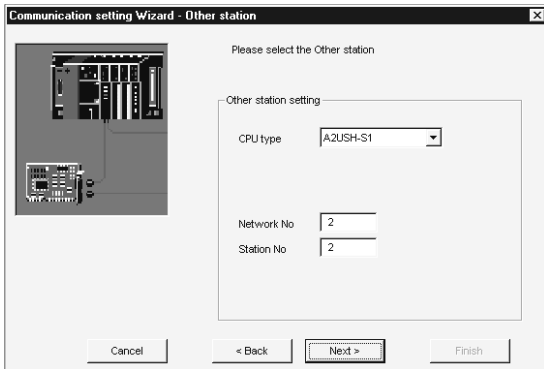

5) Make settings as indicated below and click the **Next>** button.

CPU type : A2USH-S1  
Network No. : 2  
Station No. : 2

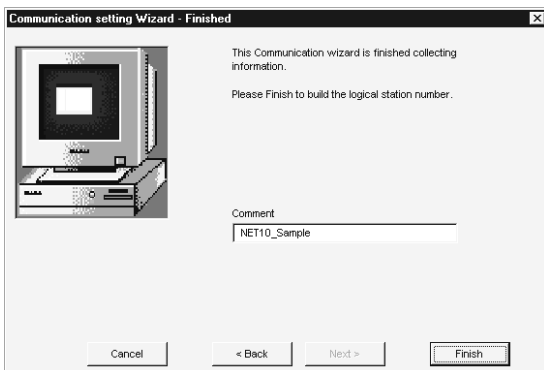

6) Enter a comment and click the **Finish** button.

(Registration complete)



(4) Checking the logical station number settings (Conducting a communication test)

Using the logical station number set in (3), check whether the MELSECNET/10 communication settings are correct or not.

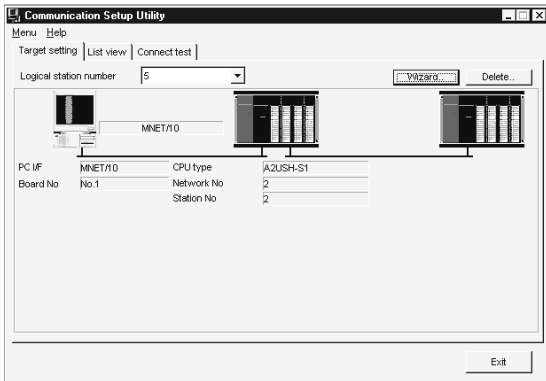

- 1) Display the target setting screen and choose the logical station number "5".  
Check whether the logical station number settings are correct or not.

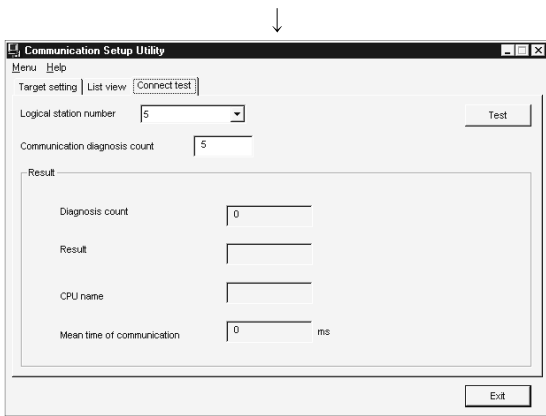

- 2) Show the connection test screen and set the logical station number "5".

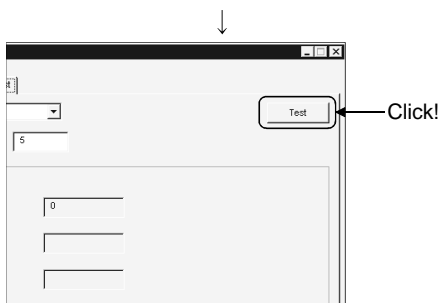

- 3) Click the **Test** button to check that communication is being made properly.  
If an error occurred, check the error code and remove the error. The error code appears in Result. (At normal termination, "0x00000000" appears in Result.)  
Refer to the programming manual for error code details.

(Communication test complete)

- 4) Through the above steps, you could confirm that the logical station number settings were correct.  
Using the set logical station number, you can create user programs and collect device information using the PLC monitor utility.

## 6.6 CC-Link Communication

This section provides the CC-Link communication procedure and its setting example using the utility setting type.

### 6.6.1 Accessing procedure

The procedure for making access to the PLC CPU using CC-Link communication will be explained in the following order.

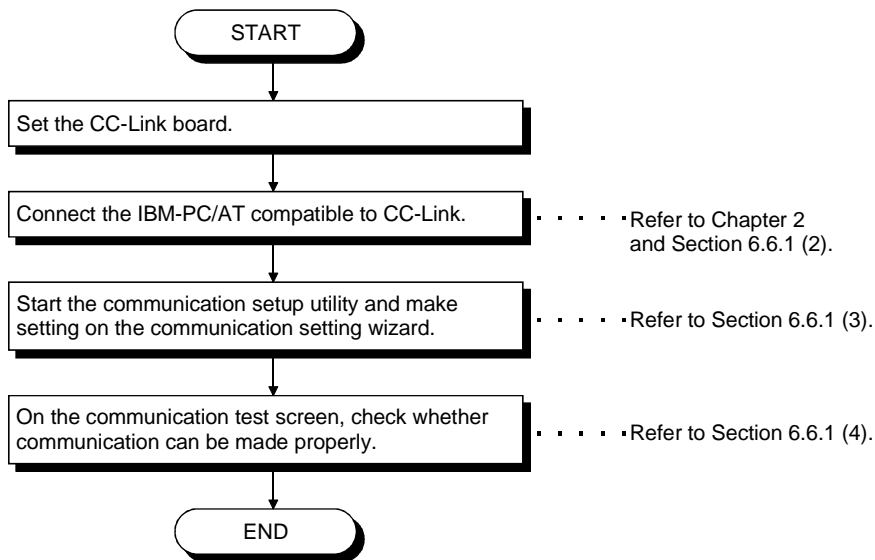

#### (1) System example

The following system example is used in this section.

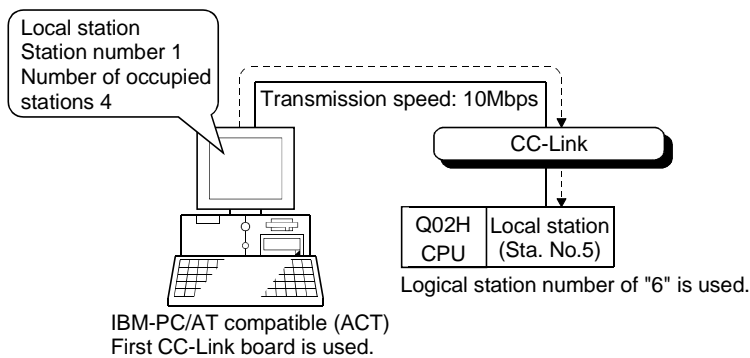

(2) Checking the CC-Link board

Check whether the IBM-PC/AT compatible is connected properly to CC-Link.

- 1) Click [Start]-[Programs]-[Melsec application]-[Communication support (CSKP-E)]-[CC-Link Board Utility] to start the CC-Link utility.

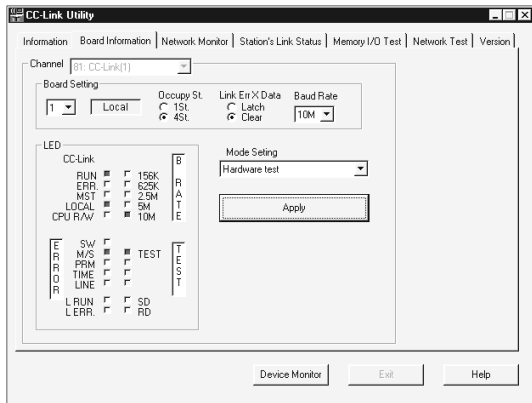

- 2) Click the "Board Information" tab and set the channel to "81:CC-Link (1)", and set the own station.

Station No. : 1  
 Occupy St. : 4 St.  
 Link Err X Data : Clear  
 Baud Rate : 10M

Set the mode to "Hardware test", click the **Apply** button, and check whether the CC-Link card is normal or not.

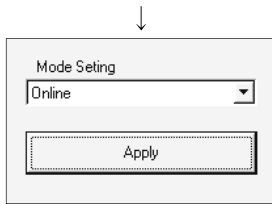

- 3) Set the mode to "Online" and click the **Apply** button.

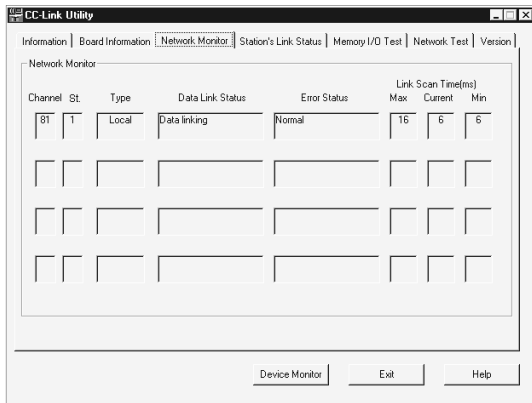

- 4) Click the "Network Monitor" tab and make sure that the loop of the own station is normal.

(Check complete)

- 5) Click the **Exit** button to exit from the utility.

(3) Setting the logical station number (Setting on communication setting wizard)

Logical station number setting will be described using the system example for (1).

1) Start the communication setup utility and choose the communication setting wizard.

2) Type "6" in Logical station number and click the **Next>** button.

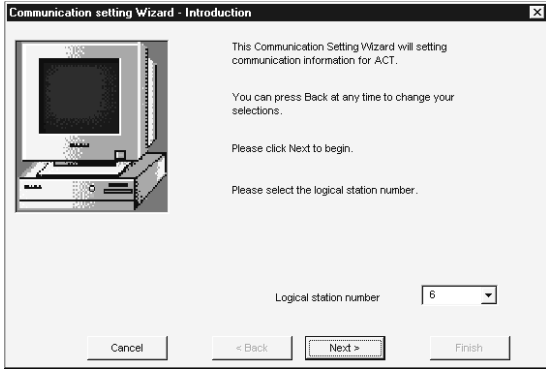

3) Make settings as indicated below and click the **Next>** button.

PC side I/F : CC-Link board  
Board No : 1stUnit

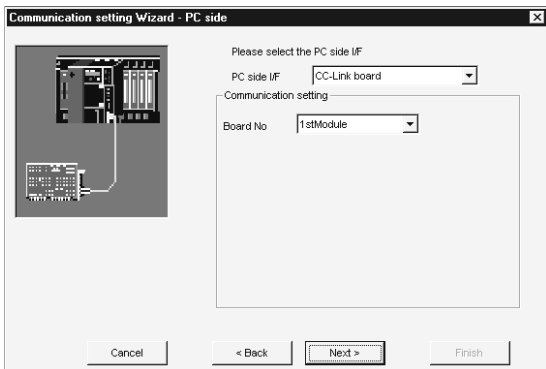

4) Make settings as indicated below and click the **Next>** button.

Station type : Other station(Single)

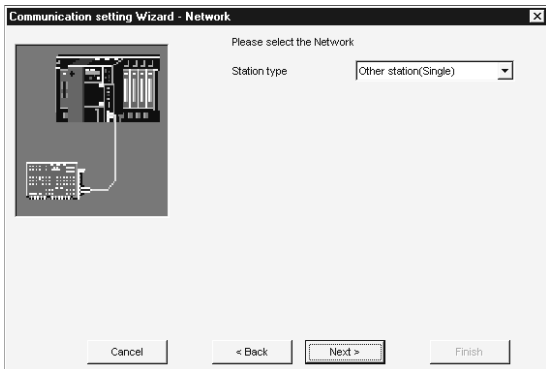

(To the next page)

(From the preceding page)

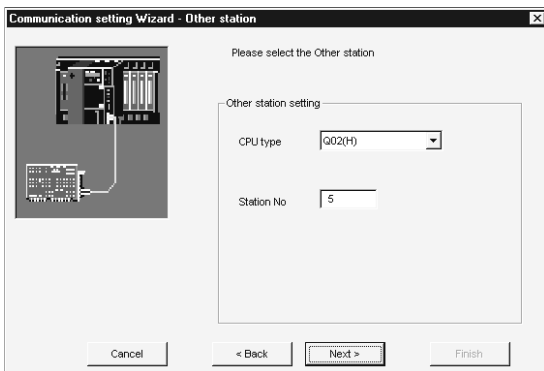

5) Make settings as indicated below and click the **Next>** button.

CPU type : Q02(H)  
Station No : 5

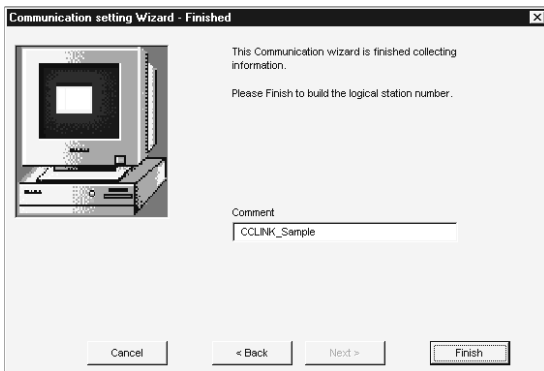

7) Enter a comment and click the **Finish** button.

(Registration complete)

(4) Checking the logical station number settings (Conducting a communication test)

Using the logical station number set in (3), check whether the CC-Link communication settings are correct or not.

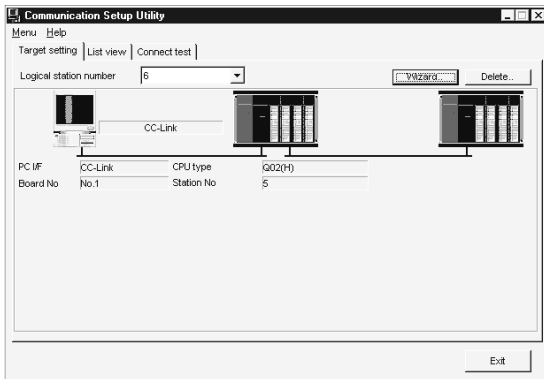

- 1) Display the target setting screen and choose the logical station number "6".  
Check whether the logical station number settings are correct or not.

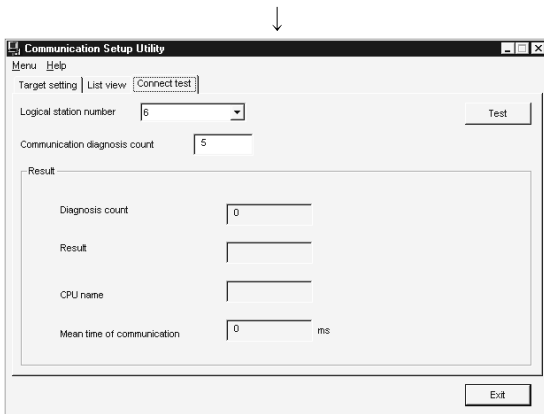

- 2) Show the connection test screen and set the logical station number "6".

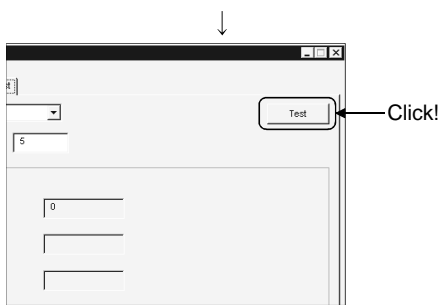

- 3) Click the **Test** button to check that communication is being made properly.  
If an error occurred, check the error code and remove the error. The error code appears in Result. (At normal termination, "0x00000000" appears in Result.)  
Refer to the programming manual for error code details.

(Communication test complete)

- 4) Through the above steps, you could confirm that the logical station number settings were correct.  
Using the set logical station number, you can create user programs and collect device information using the PLC monitor utility.

6.7 CC-Link G4 Communication

This section provides the CC-Link G4 communication procedure and its setting example using the utility setting type.

6.7.1 Switch settings of CC-Link G4 module

This section gives the switch settings of the CC-Link G4 module for use of ACT in the following system configuration.

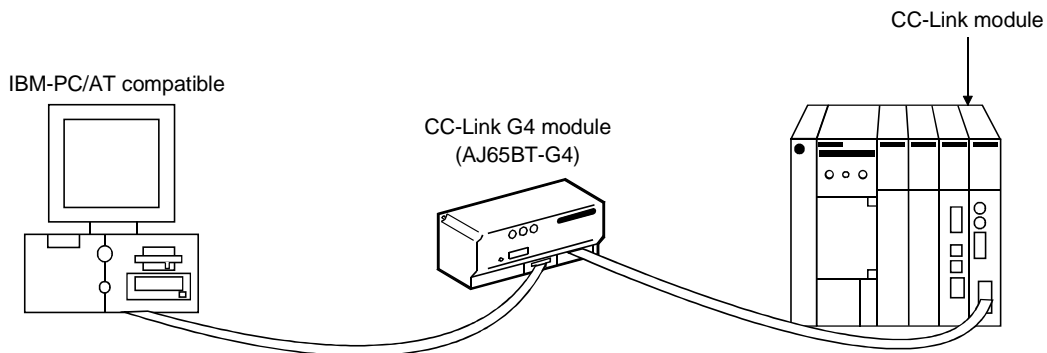

**POINT**  
 When using ACT, the settings other than "As set by user" in the tables are fixed as given in the tables.

Switch (Switch Number)		Setting												
		In QnA mode	In A mode											
Station number setting switches		As set by user												
Data link transmission speed setting switch		As set by user (match to the transmission speed of the CC-Link module)												
Operation setting DIP switches	Operation mode setting (SW1)	ON (QnA mode)	OFF (A mode)											
	Inter-peripheral transmission speed setting (SW2, SW3)	As set by user (Match to the baudrate of ACT)	9600bps <table border="1" style="margin-left: auto; margin-right: auto;"> <tr><th>SW</th><th>Setting</th></tr> <tr><td>SW2</td><td>OFF</td></tr> <tr><td>SW3</td><td>OFF</td></tr> </table>	SW	Setting	SW2	OFF	SW3	OFF					
	SW	Setting												
	SW2	OFF												
	SW3	OFF												
	Parity bit yes/no setting (SW4, SW5)	<table border="1" style="margin-left: auto; margin-right: auto;"> <tr><th>SW</th><th>Setting</th></tr> <tr><td>SW4</td><td>OFF</td></tr> <tr><td>SW5</td><td>OFF</td></tr> </table>	SW	Setting	SW4	OFF	SW5	OFF	<table border="1" style="margin-left: auto; margin-right: auto;"> <tr><th>SW</th><th>Setting</th></tr> <tr><td>SW4</td><td>OFF</td></tr> <tr><td>SW5</td><td>OFF</td></tr> </table>	SW	Setting	SW4	OFF	SW5
SW	Setting													
SW4	OFF													
SW5	OFF													
SW	Setting													
SW4	OFF													
SW5	OFF													
— (SW6)	OFF	OFF												
— (SW7)	OFF	OFF												
Test mode setting (SW8)	OFF (online mode)	OFF (online mode)												

6.7.2 Accessing procedure

The procedure for making access to the PLC CPU using CC-Link G4 communication will be explained in the following order.

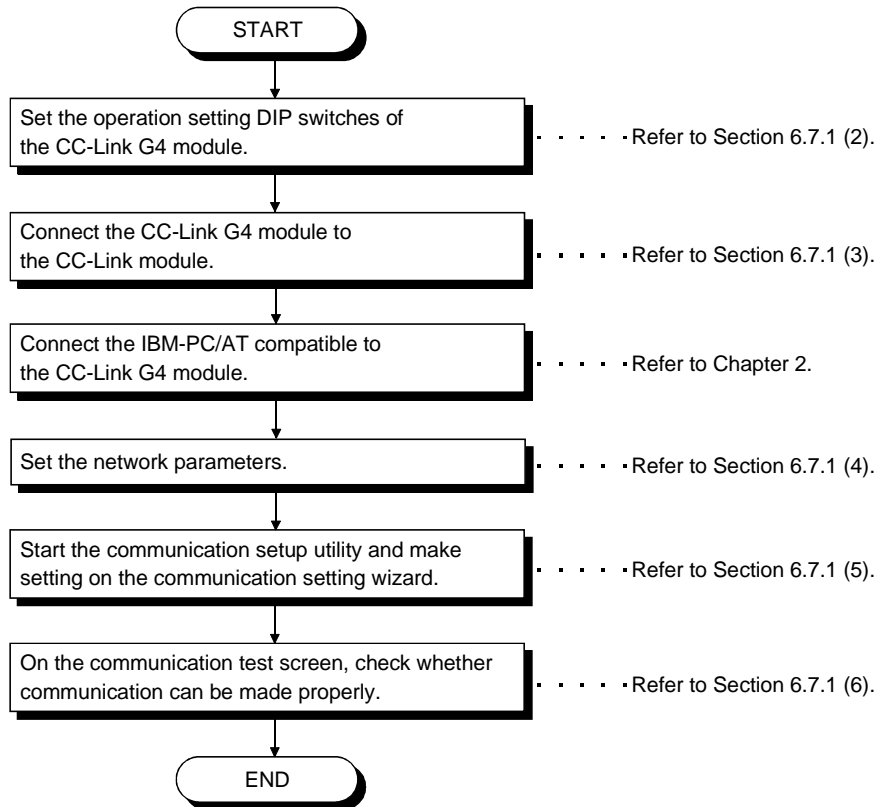

(1) System example

The following system example is used in this section.

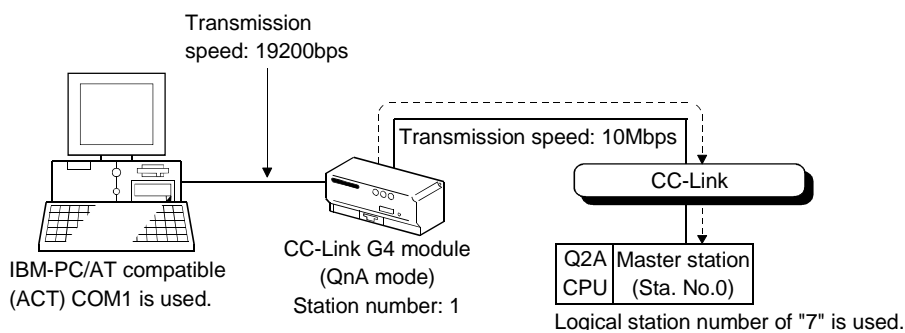



(2) Making switch settings of the CC-Link G4 module

The switch settings of the CC-Link G4 module are indicated below.

Switch (Switch Number)		Setting	
Station number setting switches		01 (station number 1)	
Data link transmission speed setting switch		4 (10Mbps)	
Operation setting DIP switches	Operation mode setting (SW1)	ON (QnA mode)	
	Inter-peripheral transmission speed setting (SW2, SW3)	19200bps	
		SW	Setting
		SW2	ON
	SW3	OFF	
	Parity bit yes/no setting (SW4, SW5)	SW	Setting
SW4		OFF	
SW5		OFF	
— (SW6)	OFF		
— (SW7)	OFF		
Test mode setting (SW8)		OFF (online mode)	

(3) Wiring the CC-Link G4 module

The diagram of wiring the CC-Link G4 module to the CC-Link module is shown below.

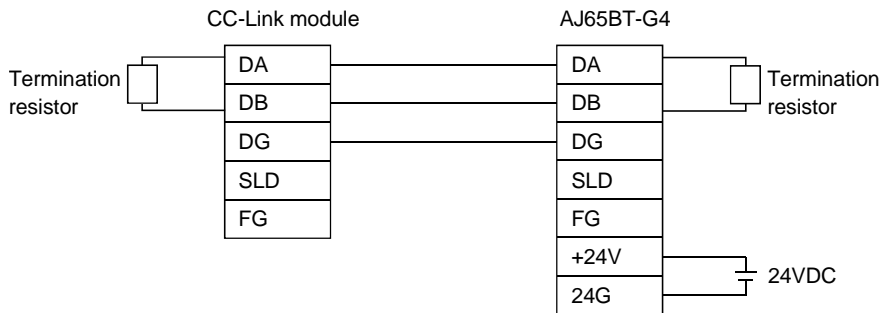

(4) Setting the network parameters

Parameter setting may either be made from the network parameter "CC-Link setting screen" of GPPW or from a sequence program.

**POINT**

When using the CC-Link G4 module in the A mode, set the parameters in accordance with "(b) Making parameter setting in sequence program".

(a) Making parameter setting on CC-Link setting screen

Set the first I/O No., type, total number of modules connected, and station information.

Set other setting items as required.

<CC-Link parameter setting screen>

No. of boards in module  Boards Blank: no setting 0 boards: Set by the sequence program.

	1	2	3	4
Start I/O No.	0000			
Type	Master station			
All connect count	1			
Remote input(RX)				
Remote output(RY)				
Remote register(RW/r)				
Remote register(RW/w)				
Special relay(SB)				
Special register(SW)				
Retry count	3			
Automatic reconnection station count	1			
Wait master station No.	0			
PLC down select	Stop			
Scan mode setting	Asynchronously			
Delay information setting	0			
Station information setting	Station information			

<Station information setting screen>

CC-Link station information. Module 1

StationNo.	Station type	Exclusive station count	Reserve/invalid station select	Intelligent buffer select(word)		
				Send	Receive	Automatic
1/1	Intelligent device station	Exclusive station 1	No setting	64	64	128

Default Check End Cancel

After setting the CC-Link parameters, write them to the PLC CPU.

(b) Making parameter setting in sequence program

The parameter setting items for data link and the sequence program example are given below.

<Parameter setting items>

Address	Item	Description	Set Value
1H	Number of connected modules	Set the number of modules on the remote/local stations connected.	1H
20H	Station information	AJ65BT-G4	2101H

<Sequence program>

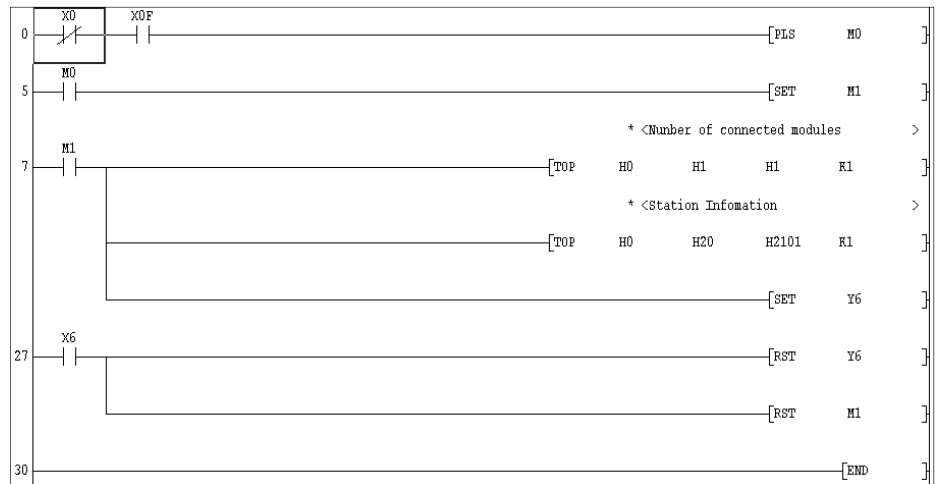

(5) Setting the logical station number (Setting on communication setting wizard)

Logical station number setting will be described using the system example for (1).

1) Start the communication setup utility and choose the communication setting wizard.

2) Type "7" in Logical station number and click the **Next>** button.

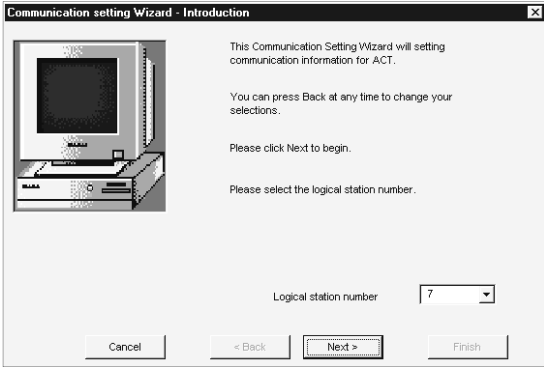

3) Make settings as indicated below and click the **Next>** button.

PC side I/F : Serial  
 Connect port : COM1  
 Time out : 10000

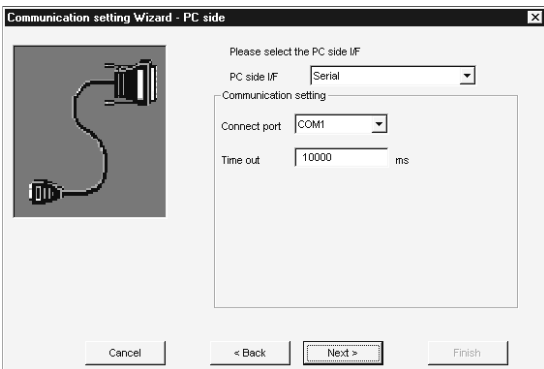

4) Make settings as indicated below and click the **Next>** button.

PLC side I/F : G4 module  
 Mode : QnA  
 Baud rate : 19200  
 Control : DTR or RTS Control

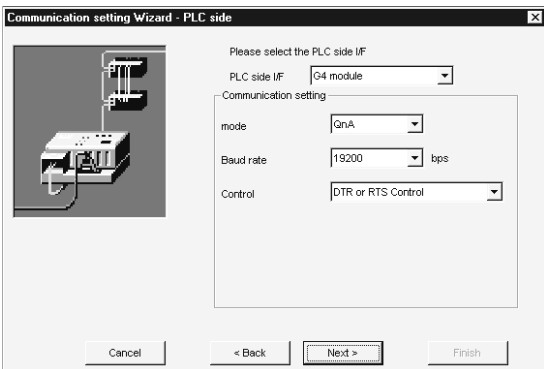

(To the next page)

(From the preceding page)

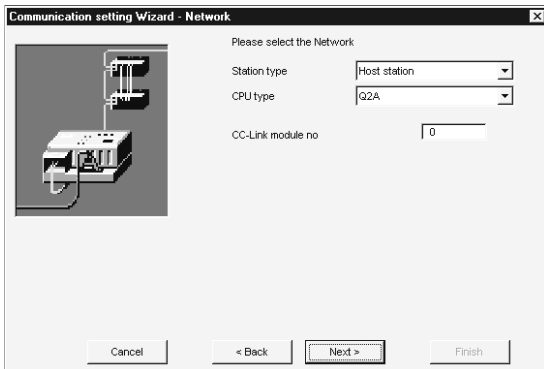

5) Make settings as indicated below and click the **Next>** button.

Station type : Host station  
CPU type : Q2A  
CC-Link module no. : 0

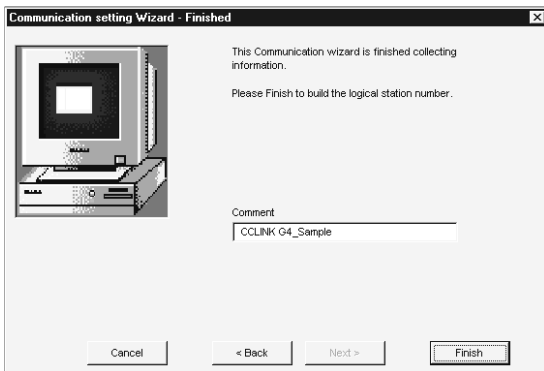

7) Enter a comment and click the **Finish** button.

(Registration complete)

(6) Checking the logical station number settings (Conducting a communication test)

Using the logical station number set in (5), check whether CC-Link G4 communication settings are correct or not.

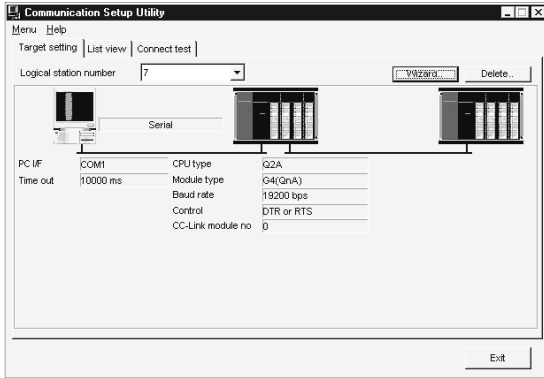

- 1) Display the target setting screen and choose the logical station number "7".  
Check whether the logical station number settings are correct or not.

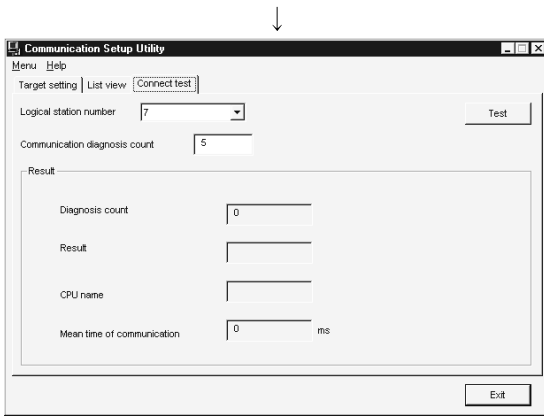

- 2) Show the connection test screen and set the logical station number "7".

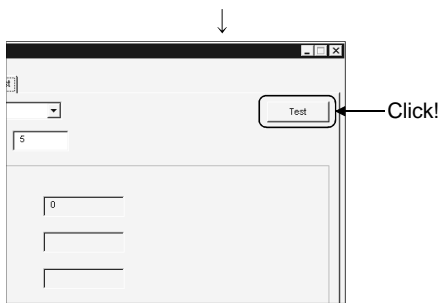

- 3) Click the **Test** button to check that communication is being made properly.  
If an error occurred, check the error code and remove the error. The error code appears in Result. (At normal termination, "0x00000000" appears in Result.)  
Refer to the programming manual for error code details.

(Communication test complete)

- 4) Through the above steps, you could confirm that the logical station number settings were correct.  
Using the set logical station number, you can create user programs and collect device information using the PLC monitor utility.

### 6.8 CPU Board Communication

This section provides the CPU board communication procedure and its setting example using the utility setting type.

#### 6.8.1 Accessing procedure

The procedure for making access to the CPU board using CPU board communication will be explained in the following order.

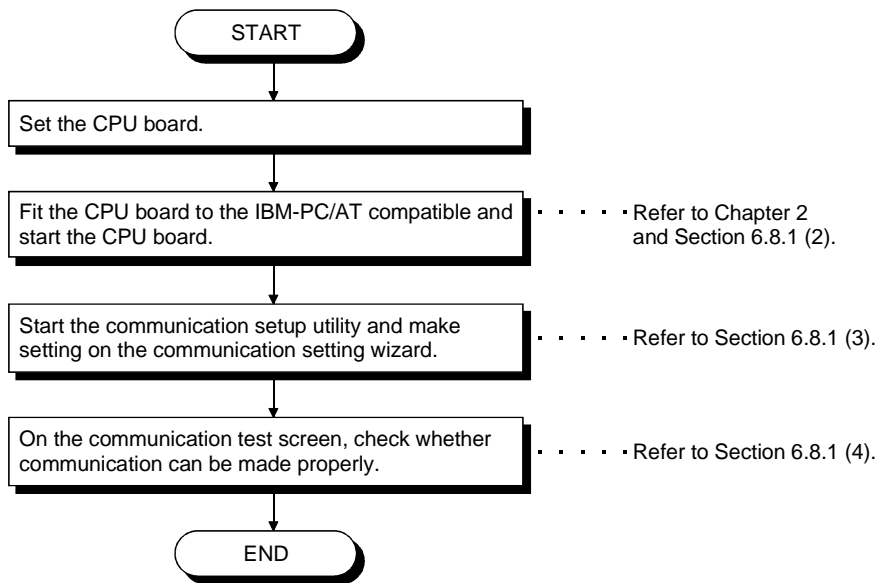

#### (1) System example

The following system example is used in this section.

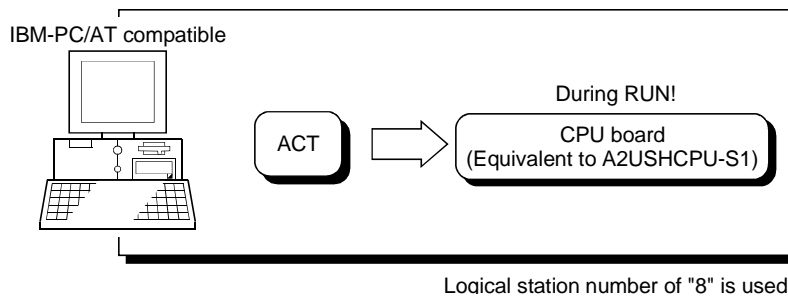

## (2) Checking and starting the CPU board

Check whether the CPU board is connected to the IBM-PC/AT compatible properly and start the CPU board.

- 1) Click [Start]-[Programs]-[Melsec]-[AnU Utility] to start the AnU utility.
- 2) Check whether the CPU board is operating properly.  
Display the memory I/O test screen and click the **Start** button to perform the test any number of times.  
Then, click the **Stop** button to stop the test and make sure that the CPU board is normal.

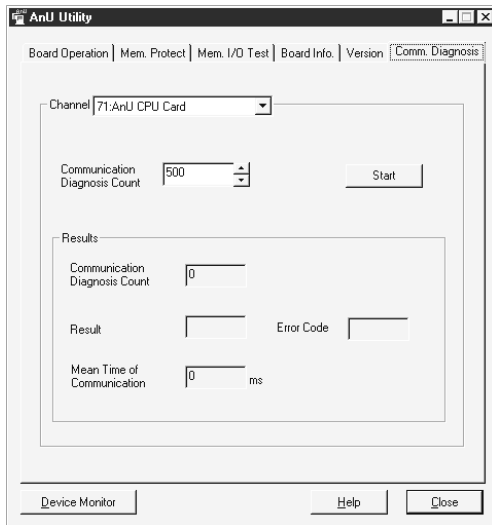
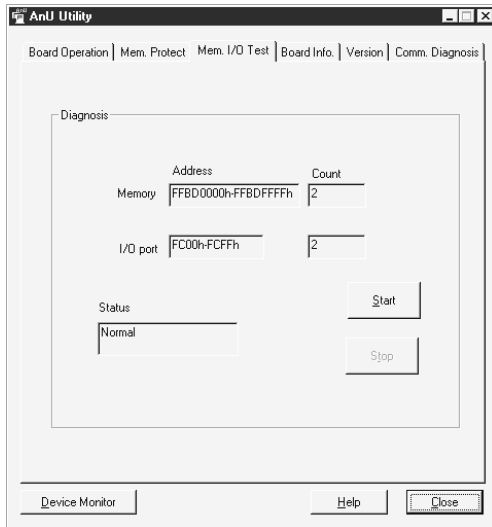

(To the next page)

- 3) Display the communication diagnosis screen and click the **Start** button to make sure that communication is made properly.  
If an error has occurred, check the error code and remove the error. (Refer to the CPU board manual.)



(From the preceding page)

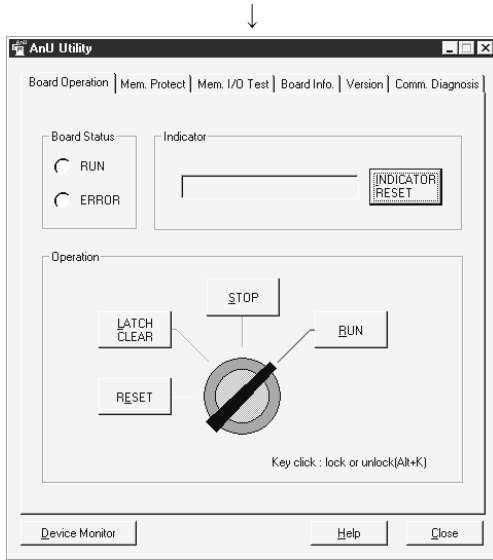

- 4) In this section, you must perform setting to make the CPU board running on the board operation screen since access is made while the CPU board is running. The board operation screen appears.

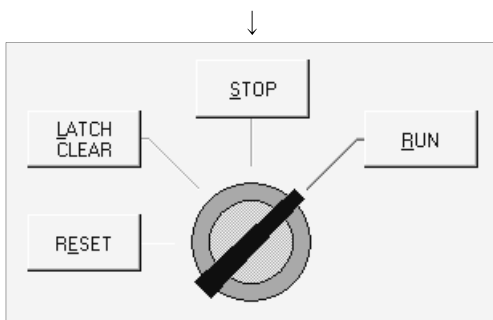

- 5) Click the CPU operation key to choose the unlock status. After choosing the unlock status, click the **RUN** button to make the CPU board running.

(Check complete)

- 6) Click the **Close** button to store the AnU utility into the taskbar.

(3) Setting the logical station number (Setting on communication setting wizard)

Logical station number setting will be described using the system example for (1).

1) Start the communication setup utility and choose the communication setting wizard.

2) Type "8" in Logical station number and click the **Next>** button.

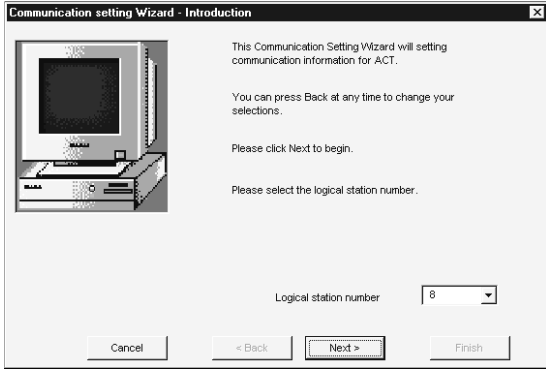

3) Make settings as indicated below and click the **Next>** button.

PC side I/F : CPU board

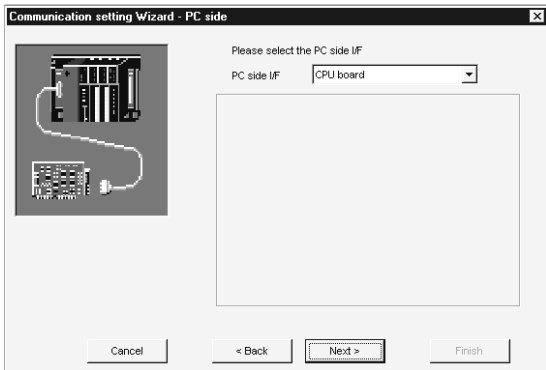

4) Make settings as indicated below and click the **Next>** button.

Station type : Host station

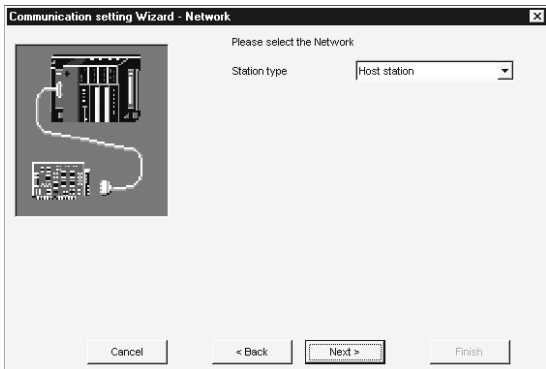

(To the next page)

(From the preceding page)

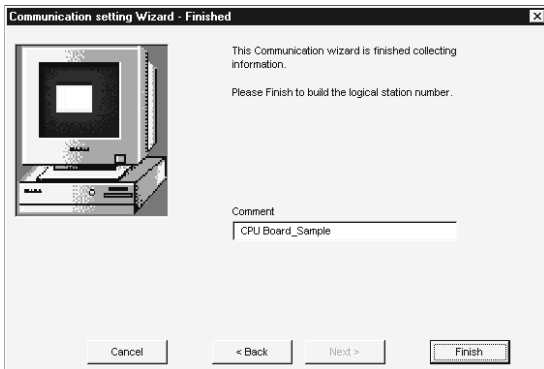

7) Enter a comment and click the **Finish** button.



(Registration complete)

(4) Checking the logical station number settings (Conducting a communication test)

Using the logical station number set in (3), check whether CPU board communication settings are correct or not.

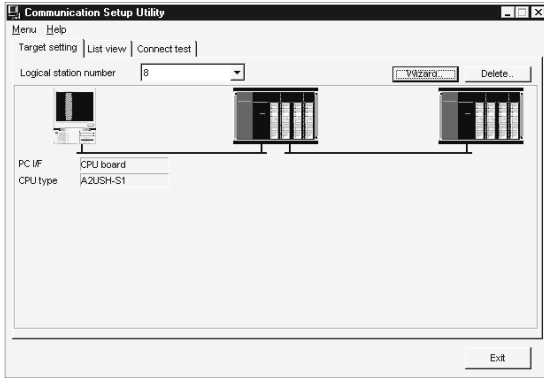

- 1) Display the target setting screen and choose the logical station number "8".  
Check whether the logical station number settings are correct or not.

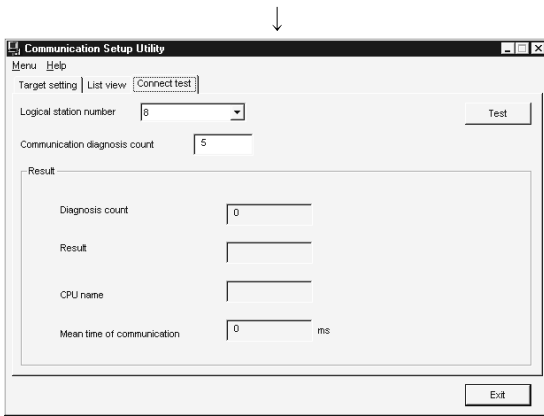

- 2) Show the connection test screen and set the logical station number "8".

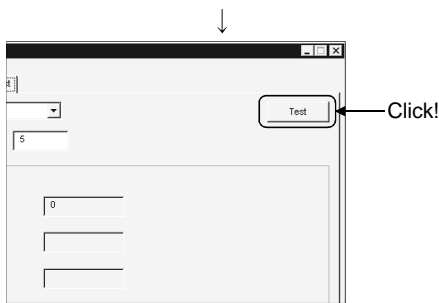

- 3) Click the **Test** button to check that communication is being made properly.  
If an error occurred, check the error code and remove the error. The error code appears in Result. (At normal termination, "0x00000000" appears in Result.)  
Refer to the programming manual for error code details.

(Communication test complete)

- 4) Through the above steps, you could confirm that the logical station number settings were correct.  
Using the set logical station number, you can create user programs and collect device information using the PLC monitor utility.

### 6.9 Ladder Logic Test Communication

This section provides the ladder logic communication procedure and its setting example using the utility setting type.

#### 6.9.1 Accessing procedure

The procedure for making access to the ladder logic test function (LLT) using ladder logic communication will be explained in the following order.

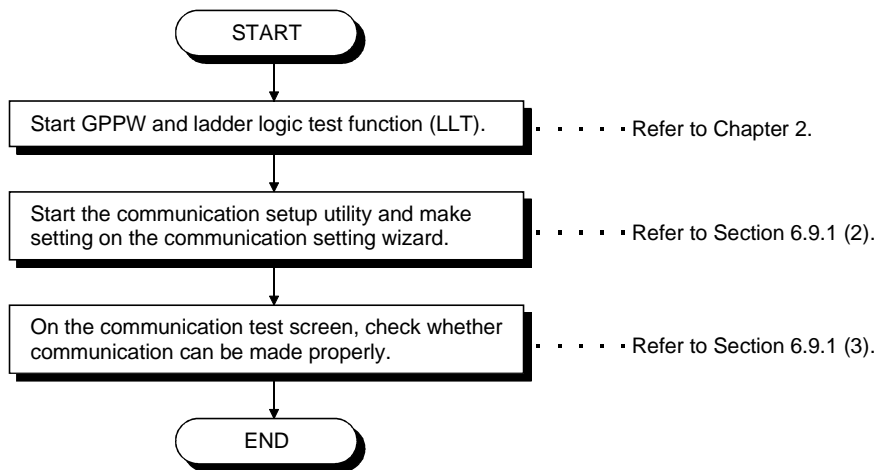

#### (1) System example

The following system example is used in this section.

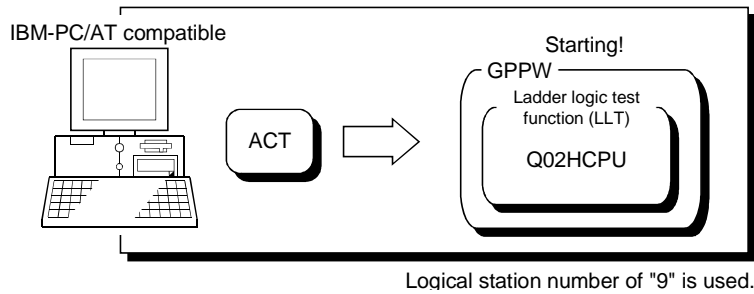

(2) Setting the logical station number (Setting on communication setting wizard)

Logical station number setting will be described using the system example for (1).

1) Start the communication setup utility and choose the communication setting wizard.

2) Type "9" in Logical station number and click the **Next>** button.

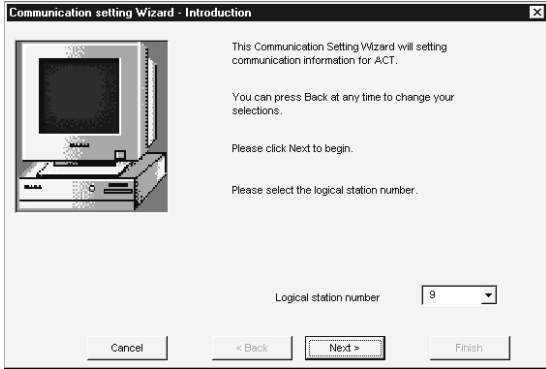

3) Make settings as indicated below and click the **Next>** button.

PC side I/F : LLT  
 CPU type : Q02(H)  
 Time out : 10000

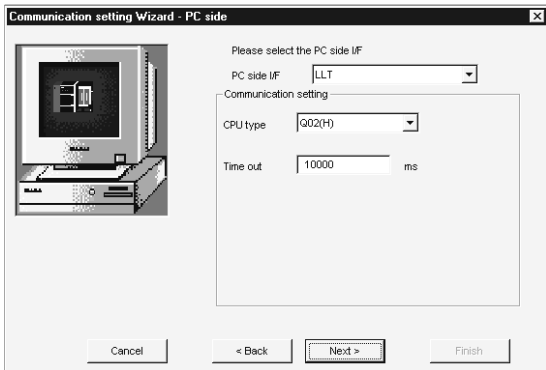

4) Enter a comment and click the **Finish** button.

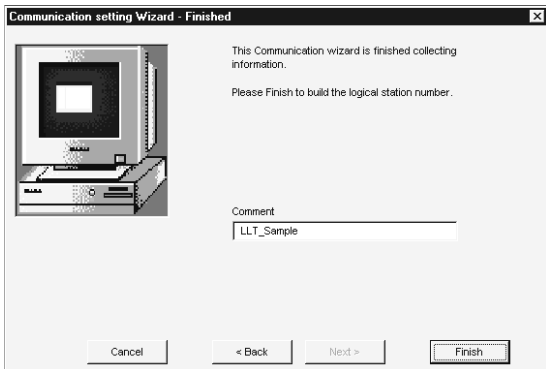

(Registration complete)

(3) Checking the logical station number settings (Conducting a communication test)

Using the logical station number set in (2), check whether ladder logic communication settings are correct or not.

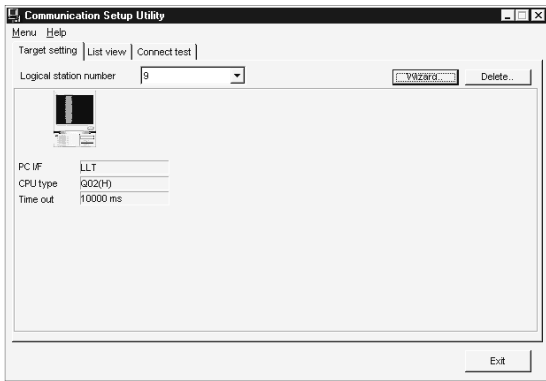

- 1) Display the target setting screen and choose the logical station number "9".  
Check whether the logical station number settings are correct or not.

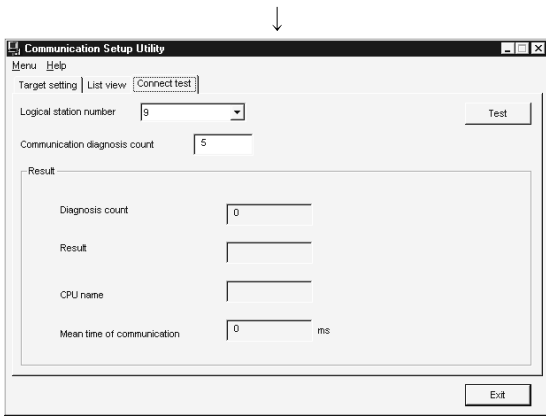

- 2) Show the connection test screen and set the logical station number "9".

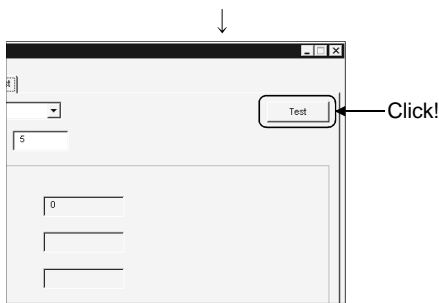

- 3) Click the **Test** button to check that communication is being made properly.  
If an error occurred, check the error code and remove the error. The error code appears in Result. (At normal termination, "0x00000000" appears in Result.)  
Refer to the programming manual for error code details.

(Communication test complete)

- 4) Through the above steps, you could confirm that the logical station number settings were correct.  
Using the set logical station number, you can create user programs and collect device information using the PLC monitor utility.

7 COMMUNICATION SETTING EXAMPLES OF THE PROGRAM SETTING TYPE

To make communication using the program setting type, you must set the properties of the corresponding ACT controls.

For the properties of the corresponding ACT controls, directly enter them in the VB or VC window or change their settings in the user program.

Refer to the ACT programming manual for details of the properties which must be set for the corresponding ACT controls.

**POINT**

Refer to the following sections for the switch settings of the computer link, Ethernet and CC-Link G4 modules for use of ACT.

- Computer link module ..... Section 6.1.1 Switch settings of computer link modules
- Ethernet module ..... Section 6.2.1 Switch settings of Ethernet modules
- CC-Link G4 module ..... Section 6.7.1 Switch settings of CC-Link G4 module

**REMARK**

On ACT, the following property setting method is available for those who are not familiar with property setting.

<Property setting changing procedure>

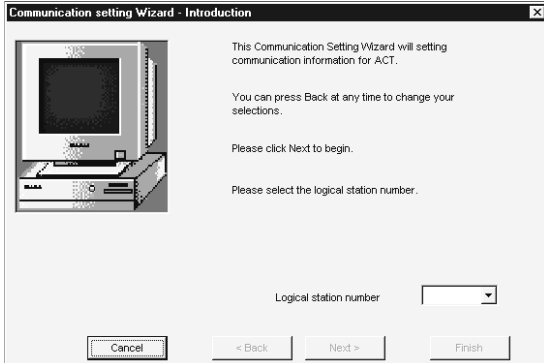

- 1) Specify the communication path where you want to make property setting using the "Communication setting Wizard" on the communication setup utility.

For details of the communication setting wizard, refer to "Section 5.1.6 Operations on the communication setting wizard screen".

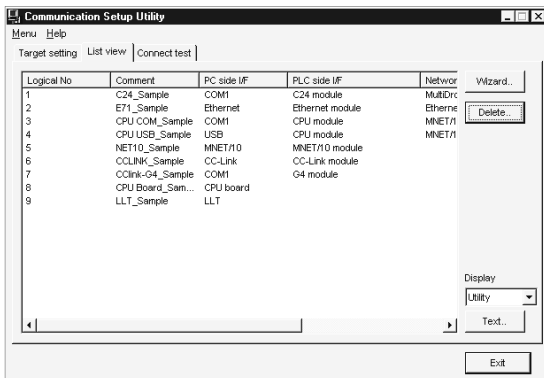

- 2) Display the "List view" screen of the communication setup utility.

For details of the "List view" screen, refer to "Section 5.1.2 Operations on list view screen".

(To the next page)



(From the preceding page)

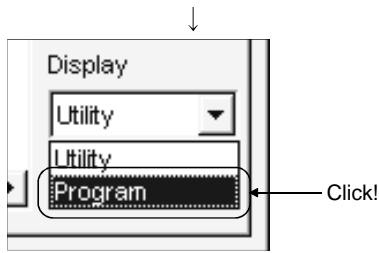

3) Choose "Program" in "Display" on the "List view" screen.

Control names to be used and properties to be set appear.

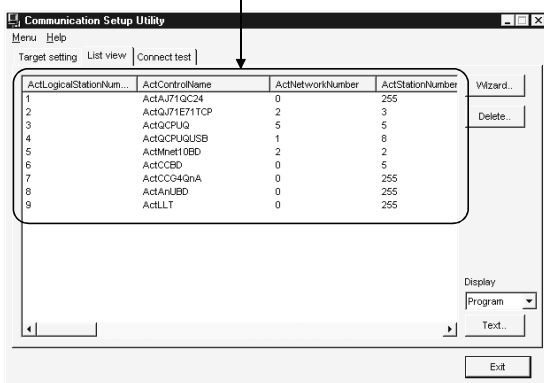

4) Control the scroll bar on the "List view" screen to confirm the properties.

The "List view" screen shows the properties that are needed for setting using the program setting type.

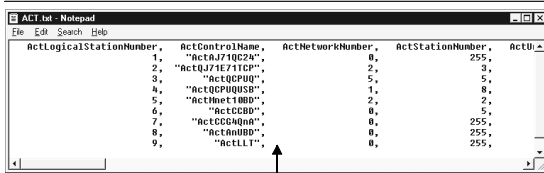

Clicking the **Text** button on the "List view" screen enables you to save the data into a file in the txt format.

Saved into file in txt format.

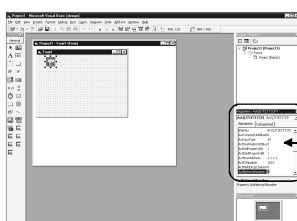

5) When creating a user program, directly enter the confirmed property values into Properties of the property window or change the property setting in the user program. The screen used for explanation uses VB.

## 8 ACCESSIBLE DEVICES AND RANGES

This chapter describes the accessible devices and accessible ranges in each communication form.

### 8.1 Precautions for Device Access

#### (1) About accessible devices

For accessible devices, the devices not given or devices marked × (inaccessible) in the accessible device list indicated in Sections 8.2 and later are not supported by ACT.

Do not specify the inaccessible devices.

#### (2) Precautions for making access to extended file registers

It is possible (depending on the type of memory cassette mounted on the PLC CPU) that no errors will occur even when a device is read and written by specifying a block number which does not exist. In such a case, the data read is not correct. Further, writing to that device may destroy the user memory of the PLC CPU.

Make sure to use the function described here, after fully confirming the kind of memory cassette, details of parameter setting, etc.

For details, refer to the AnACPU and AnUCPU User's Manual.

8.2 For Computer Link Communication

This section provides the accessible devices and accessible ranges for computer link communication.

8.2.1 Accessible devices

The following table indicates the accessible devices for computer link communication.

Device (Device Name)	Access Target							
	A1N	A0J2H A1S(-S1) A1SH(-S1) A1SJH A1SJ A2C(J) A2N(-S1) A2S(-S1) A2SH(-S1) A1FX	A2A(-S1) A2U(-S1) A2US(-S1) A2AS (-S1/-S30) A2USH-S1 Q02(H)-A Q06H-A	A3N A3A A3U	A4U	Q2A(-S1) Q3A Q4A Q4AR Q2AS(-S1) Q2ASH(-S1) Q02(H) Q06H Q12H Q25H	FX <sub>0</sub> FX <sub>0S</sub> FX <sub>0N</sub> FX <sub>1</sub> FX <sub>1N</sub> FX <sub>1S</sub> FX <sub>2</sub> FX <sub>2C</sub> FX <sub>2N</sub> FX <sub>2NC</sub>	A273UH(-S3) A171SH A172SH A173UH (-S1)
Function input (FX)	×	×	×	×	×	○	×	×
Function output (FY)	×	×	×	×	×	○	×	×
Function register (FD)	×	×	×	×	×	○	×	×
Special relay (SM)	○	○	○	○	○	○	×	○
Special register (SD)	○	○	○	○	○	○	×	○
Input relay (X)	○	○	○	○	○	○	×	○
Output relay (Y)	○	○	○	○	○	○	×	○
Internal relay (M)	○	○	○	○	○	○	×	○
Latch relay (L)	○	○	○	○	○	○	×	○
Annunciator (F)	○	○	○	○	○	○	×	○
Edge relay (V)	×	×	×	×	×	○	×	×
Link relay (B)	○	○	○	○	○	○	×	○
Data register (D)	○	○	○	○	○	○	×	○
Link register (W)	○	○	○	○	○	○	×	○
Timer	Contact (TS)	○	○	○	○	○	×	○
	Coil (TC)	○	○	○	○	○	×	○
	Present value (TN)	○	○	○	○	○	×	○
Counter	Contact (CS)	○	○	○	○	○	×	○
	Coil (CC)	○	○	○	○	○	×	○
	Present value (CN)	○	○	○	○	○	×	○
Retentive timer	Contact (SS)	×	×	×	×	○	×	×
	Coil (SC)	×	×	×	×	○	×	×
	Present value (SN)	×	×	×	×	○	×	×
Link special relay (SB)	×	×	×	×	×	○	×	×
Link special register (SW)	×	×	×	×	×	○	×	×
Step relay (S)	○	○	○	○	○	×	×	○
Direct input (DX)	×	×	×	×	×	×	×	×
Direct output (DY)	×	×	×	×	×	×	×	×
Accumulator (A)	○	○	○	○	○	×	×	○
Index register	(Z)	○	○	○	○	○	×	○
	(V)	○	○	○	○	○	×	○
File register	(R)	○	○	○	○	○	×	○
	(ZR)	×	×	×	×	○	×	×
Extended file register (ER *1R)	○	○	○	○	○	×	×	○

Device (Device Name)		Access Target							
		A1N	A0J2H A1S(-S1) A1SH(-S1) A1SJH A1SJ A2C(J) A2N(-S1) A2S(-S1) A2SH(-S1) A1FX	A2A(-S1) A2U(-S1) A2US(-S1) A2AS (-S1/-S30) A2USH-S1 Q02(H)-A Q06H-A	A3N A3A A3U	A4U	Q2A(-S1) Q3A Q4A Q4AR Q2AS(-S1) Q2ASH(-S1) Q02(H) Q06H Q12H Q25H	FX <sub>0</sub> FX <sub>0S</sub> FX <sub>0N</sub> FX <sub>1</sub> FX <sub>1N</sub> FX <sub>1S</sub> FX <sub>2</sub> FX <sub>2C</sub> FX <sub>2N</sub> FX <sub>2NC</sub>	A273UH(-S3) A171SH A172SH A173UH (-S1)
Direct link	Link input (J*\X)	×	×	×	×	×	○	×	×
	Link output (J*\Y)	×	×	×	×	×	○	×	×
	Link relay (J*\B)	×	×	×	×	×	○	×	×
	Link special relay (J*\SB)	×	×	×	×	×	○	×	×
	Link register (J*\W)	×	×	×	×	×	○	×	×
	Link special register (J*\SW)	×	×	×	×	×	○	×	×
Special direct buffer memory (U*\G)		×	×	×	×	×	○	×	×

8.2.2 Accessible ranges

This section indicates the accessible ranges for computer link communication.

(1) Configuration

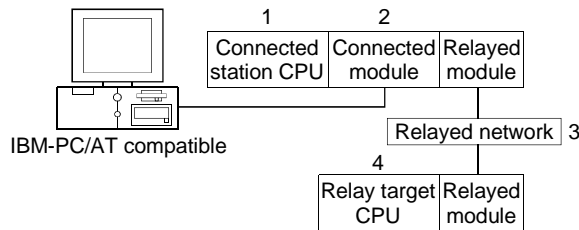

(2) Accessibility list

The following table indicates whether access can be made or not.

The connected station CPUs are all accessible.

Whether the relay target CPU is accessible or not is indicated by ○ (accessible) or × (inaccessible).

Connected Station		3. Relayed Network	4. Relay Target CPU					
1. CPU	2. Connected module (Usable control name)		QCPU		QnACPU	ACPU	FXCPU	Motion controller CPU
			Q mode	A mode				
QCPU (Q mode)	Q series-compatible C24*1 (ActQJ71C24)	MELSECNET/10H	○	×	×	×	×	×
		MELSECNET/10	○	○	○	○	×	○
		MELSECNET(II)	×	×	×	×	×	×
		Ethernet	○ *2	×	○ *2	×	×	×
		Computer link	○	×	○	×	×	×
		CC-Link	○	○	○	○	×	○
		Multidrop (Independent mode)	○	×	○	×	×	×
		Multidrop (Synchronous mode) *1	○	×	×	×	×	×
QnACPU	QC24(N) (ActAJ71QC24)	MELSECNET/10H	×	×	×	×	×	×
		MELSECNET/10	×	×	○	×	×	×
		MELSECNET(II)	×	×	○	×	×	×
		Ethernet	×	×	○ *2	×	×	×
		Computer link	×	×	○	×	×	×
		CC-Link	×	×	○	×	×	×
		Multidrop (Independent mode)	×	×	○	×	×	×
		Multidrop (Synchronous mode)	×	×	○	×	×	×

\*1: Always set the transmission specifications software switch setting "SW6 (sumcheck)" of the Q series-compatible C24 parameters to ON.

\*2: Set the parameter-set values of the target station side QE71 to the network number and station number.

Also set the "MNET/10 routing information" of the QE71 parameter setting.

At that time, specify any of the IP address calculation system, table conversion system and combined system as the "MNET/10 routing system".

Connected Station		3. Relayed Network	4. Relay Target CPU					
1. CPU	2. Connected module (Usable control name)		QCPU		QnACPU	ACPU	FXCPU	Motion controller CPU
			Q mode	A mode				
QCPU (A mode), QnACPU *3, ACPU, motion controller CPU	UC24 (ActAJ71UC24)	MELSECNET/10H	×	×	×	×	×	×
		MELSECNET/10	×	○	○ *3	○	×	○
		MELSECNET(II)	×	○	○ *3	○	×	○
		Ethernet	×	×	×	×	×	×
		Computer link	×	×	×	×	×	×
		CC-Link	×	×	×	×	×	×
		Multidrop	×	○	○ *3	○	×	○
QCPU (A mode), QnACPU *3, ACPU, motion controller CPU	C24 (ActAJ71C24)	MELSECNET/10H	×	×	×	×	×	×
		MELSECNET/10	×	○	○ *3	○	×	○
		MELSECNET(II)	×	○	○ *3	○	×	○
		Ethernet	×	×	×	×	×	×
		Computer link	×	×	×	×	×	×
		CC-Link	×	×	×	×	×	×
		Multidrop	×	○	○ *3	○	×	○

\*3: Operates as the one equivalent to AnACPU.

8.3 For Ethernet Communication

This section provides the accessible devices and accessible ranges for Ethernet communication.

8.3.1 Accessible devices

The following table indicates the accessible devices for Ethernet communication.

Device (Device Name)	Access Target							
	A1N	A0J2H A1S(-S1) A1SH(-S1) A1SJH A1SJ A2C(J) A2N(-S1) A2S(-S1) A2SH(-S1) A1FX	A2A(-S1) A2U(-S1) A2US(-S1) A2AS (-S1/-S30) A2USH-S1 Q02(H)-A Q06H-A	A3N A3A A3U	A4U	Q2A(-S1) Q3A Q4A Q4AR Q2AS(-S1) Q2ASH(-S1) Q02(H) Q06H Q12H Q25H	FX <sub>0</sub> FX <sub>0S</sub> FX <sub>0N</sub> FX <sub>1</sub> FX <sub>1N</sub> FX <sub>1S</sub> FX <sub>2</sub> FX <sub>2C</sub> FX <sub>2N</sub> FX <sub>2NC</sub>	A273UH(-S3) A171SH A172SH A173UH (-S1)
Function input (FX)	×	×	×	×	×	○ *2	×	×
Function output (FY)	×	×	×	×	×	○ *2	×	×
Function register (FD)	×	×	×	×	×	○ *2	×	×
Special relay (SM)	○	○	○	○	○	○	×	○
Special register (SD)	○	○	○	○	○	○	×	○
Input relay (X)	○	○	○	○	○	○	×	○
Output relay (Y)	○	○	○	○	○	○	×	○
Internal relay (M)	○	○	○	○	○	○	×	○
Latch relay (L)	○	○	○	○	○	○	×	○
Annunciator (F)	○	○	○	○	○	○	×	○
Edge relay (V)	×	×	×	×	×	○	×	×
Link relay (B)	○	○	○	○	○	○	×	○
Data register (D)	○	○	○	○	○	○	×	○
Link register (W)	○	○	○	○	○	○	×	○
Timer	Contact (TS)	○	○	○	○	○	×	○
	Coil (TC)	○	○	○	○	○	×	○
	Present value (TN)	○	○	○	○	○	×	○
Counter	Contact (CS)	○	○	○	○	○	×	○
	Coil (CC)	○	○	○	○	○	×	○
	Present value (CN)	○	○	○	○	○	×	○
Retentive timer	Contact (SS)	×	×	×	×	○	×	×
	Coil (SC)	×	×	×	×	○	×	×
	Present value (SN)	×	×	×	×	○	×	×
Link special relay (SB)	×	×	×	×	×	○	×	×
Link special register (SW)	×	×	×	×	×	○	×	×
Step relay (S)	○	○	○	○	○	×	×	○
Direct input (DX)	×	×	×	×	×	×	×	×
Direct output (DY)	×	×	×	×	×	×	×	×
Accumulator (A)	○ *1	○ *1	○ *1	○ *1	○ *1	×	×	○ *1
Index register	(Z)	○ *1	○ *1	○ *1	○ *1	○	×	○ *1
	(V)	○ *1	○ *1	○ *1	○ *1	○ *1	×	○ *1
File register	(R)	○	○	○	○	○	×	○
	(ZR)	×	×	×	×	○	×	×
Extended file register (ER *R)	○	○	○	○	○	×	×	○

\*1: Disabled when E71 (TCP/IP) is used.  
\*2: Disabled when QE71 (TCP/IP) is used.

Device (Device Name)		Access Target							
		A1N	A0J2H A1S(-S1) A1SH(-S1) A1SJH A1SJ A2C(J) A2N(-S1) A2S(-S1) A2SH(-S1) A1FX	A2A(-S1) A2U(-S1) A2US(-S1) A2AS (-S1/-S30) A2USH-S1 Q02(H)-A Q06H-A	A3N A3A A3U	A4U	Q2A(-S1) Q3A Q4A Q4AR Q2AS(-S1) Q2ASH(-S1) Q02(H) Q06H Q12H Q25H	FX <sub>0</sub> FX <sub>0S</sub> FX <sub>0N</sub> FX <sub>1</sub> FX <sub>1N</sub> FX <sub>1S</sub> FX <sub>2</sub> FX <sub>2C</sub> FX <sub>2N</sub> FX <sub>2NC</sub>	A273UH(-S3) A171SH A172SH A173UH (-S1)
Direct link	Link input (J*\X)	×	×	×	×	×	○	×	×
	Link output (J*\Y)	×	×	×	×	×	○	×	×
	Link relay (J*\B)	×	×	×	×	×	○	×	×
	Link special relay (J*\SB)	×	×	×	×	×	○	×	×
	Link register (J*\W)	×	×	×	×	×	○	×	×
	Link special register (J*\SW)	×	×	×	×	×	○	×	×
Special direct buffer memory (U*\G)		×	×	×	×	×	○	×	×



8.3.2 Accessible ranges

This section indicates the accessible ranges for Ethernet communication.

(1) Configuration

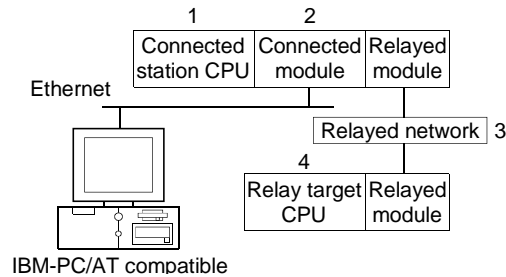

(2) Accessibility list

The following table indicates whether access can be made or not.

The connected station CPUs are all accessible.

Whether the relay target CPU is accessible or not is indicated by ○ (accessible) or × (inaccessible).

**POINT**  
 When using the Q series-compatible E71 or QE71 (when UDP/IP is used), you must set the Ethernet parameters in GPPW parameter setting.

Connected Station		3. Relayed Network	4. Relay Target CPU					
1. CPU	2. Connected module (Usable control name)		QCPU		QnACPU	ACPU	FXCPU	Motion controller CPU
			Q mode	A mode				
QCPU (Q mode)	Q series-compatible E71 (ActQJ7E71TCP)	MELSECNET/10H *1	○	×	×	×	×	×
		MELSECNET/10 *1	○	○	○	○	×	○
		MELSECNET(II)	×	×	×	×	×	×
		Ethernet	○ *2	×	○ *2	×	×	×
		Computer link	○	×	×	×	×	×
		CC-Link	○	×	×	×	×	×
QCPU (Q mode)	Q series-compatible E71 (ActQJ7E71UDP)	MELSECNET/10H *1	○	×	×	×	×	×
		MELSECNET/10 *1	○	○	○	○	×	○
		MELSECNET(II)	×	×	×	×	×	×
		Ethernet	○ *2	×	○ *2	×	×	×
		Computer link	○	×	×	×	×	×
		CC-Link	○	×	×	×	×	×

\*1: On the connected station side (Q series-compatible E71), always specify the station number set in the Ethernet parameter.

\*2: Set the parameter-set values of the target station side QE71 to the network number and station number.

Also set the "MNET/10 routing information" of the QE71 parameter setting.

At that time, specify any of the IP address calculation system, table conversion system and combined system as the "MNET/10 routing system".

Connected Station		3. Relayed Network	4. Relay Target CPU					
1. CPU	2. Connected module (Usable control name)		QCPU		QnACPU	ACPU	FXCPU	Motion controller CPU
			Q mode	A mode				
QnACPU *5	QE71 (ActAJ71QE71TCP)	MELSECNET/10H	×	×	×	×	×	×
		MELSECNET/10	×	×	○ *5	×	×	×
		MELSECNET(II)	×	×	×	×	×	×
		Ethernet	×	×	×	×	×	×
		Computer link	×	×	×	×	×	×
		CC-Link	×	×	×	×	×	×
QnACPU	QE71 (ActAJ71QE71UDP)	MELSECNET/10H	×	×	×	×	×	×
		MELSECNET/10	×	×	○	×	×	×
		MELSECNET(II)	×	×	×	×	×	×
		Ethernet	×	×	○ *2*3	×	×	×
		Computer link	×	×	○ *3	×	×	×
		CC-Link	×	×	×	×	×	×
QCPU (A mode), QnACPU *4, ACPU, motion controller CPU	E71 (ActAJ71E71TCP)	MELSECNET/10H	×	×	×	×	×	×
		MELSECNET/10	×	○	○ *4	○	×	○
		MELSECNET(II)	×	○	○ *4	○	×	○
		Ethernet	×	×	×	×	×	×
		Computer link	×	×	×	×	×	×
		CC-Link	×	×	×	×	×	×
QCPU (A mode), QnACPU *4, ACPU, motion controller CPU	E71 (ActAJ71E71UDP)	MELSECNET/10H	×	×	×	×	×	×
		MELSECNET/10	×	○	○ *4	○	×	○
		MELSECNET(II)	×	○	○ *4	○	×	○
		Ethernet	×	×	×	×	×	×
		Computer link	×	×	×	×	×	×
		CC-Link	×	×	×	×	×	×

\*2: Set the parameter-set values of the target station side QE71 to the network number and station number.

Also set the "MNET/10 routing information" of the QE71 parameter setting.

At that time, specify any of the IP address calculation system, table conversion system and combined system as the "MNET/10 routing system".

\*3: Inaccessible when TCP/IP is selected.

\*4: Operates as the one equivalent to A3ACPU.

\*5: CPU codes acquired are all 0x21.

8.4 For CPU COM Communication

This section provides the accessible devices and accessible ranges for CPU COM communication.

8.4.1 Accessible devices

The following table indicates the accessible devices for CPU COM communication.

Device (Device Name)	Access Target							
	A1N	A0J2H A1S(-S1) A1SH(-S1) A1SJH A1SJ A2C(J) A2N(-S1) A2S(-S1) A2SH(-S1) A1FX	A2A(-S1) A2U(-S1) A2US(-S1) A2AS (-S1/-S30) A2USH-S1 Q02(H)-A Q06H-A	A3N A3A A3U	A4U	Q2A(-S1) Q3A Q4A Q4AR Q2AS(-S1) Q2ASH(-S1) Q02(H) Q06H Q12H Q25H	FX <sub>0</sub> FX <sub>0S</sub> FX <sub>0N</sub> FX <sub>1</sub> FX <sub>1N</sub> FX <sub>1S</sub> FX <sub>2</sub> FX <sub>2C</sub> FX <sub>2N</sub> FX <sub>2NC</sub>	A273UH(-S3) A171SH A172SH A173UH (-S1)
Function input (FX)	×	×	×	×	×	○	×	×
Function output (FY)	×	×	×	×	×	○	×	×
Function register (FD)	×	×	×	×	×	○	×	×
Special relay (SM)	○	○	○	○	○	○	×	○
Special register (SD)	○	○	○	○	○	○	×	○
Input relay (X)	○	○	○	○	○	○	○	○
Output relay (Y)	○	○	○	○	○	○	○	○
Internal relay (M)	○	○	○	○	○	○	○	○
Latch relay (L)	○	○	○	○	○	○	×	○
Annunciator (F)	○	○	○	○	○	○	×	○
Edge relay (V)	×	×	×	×	×	○	×	×
Link relay (B)	○	○	○	○	○	○	×	○
Data register (D)	○	○	○	○	○	○	○	○
Link register (W)	○	○	○	○	○	○	×	○
Timer	Contact (TS)	○	○	○	○	○	○	○
	Coil (TC)	○	○	○	○	○	○	○
	Present value (TN)	○	○	○	○	○	○	○
Counter	Contact (CS)	○	○	○	○	○	○	○
	Coil (CC)	○	○	○	○	○	○	○
	Present value (CN)	○	○	○	○	○	○	○
Retentive timer	Contact (SS)	×	×	×	×	○	×	×
	Coil (SC)	×	×	×	×	○	×	×
	Present value (SN)	×	×	×	×	○	×	×
Link special relay (SB)	×	×	×	×	×	○	×	×
Link special register (SW)	×	×	×	×	×	○	×	×
Step relay (S)	○	○	○	○	○	×	○	○
Direct input (DX)	×	×	×	×	×	×	×	×
Direct output (DY)	×	×	×	×	×	×	×	×
Accumulator (A)	○	○	○	○	○	×	×	○
Index register	(Z)	○	○	○	○	○	○ *1	○
	(V)	○	○	○	○	○	×	○ *1
File register	(R)	○	○	○	○	○	×	○ *2
	(ZR)	×	×	×	×	○	×	×
Extended file register (ER *1R)	○	○	○	○	○	×	×	○

\*1: Data cannot be written to 2 or more consecutive points using WriteDeviceBlock(). (Data may be written to only one point.)

\*2: When specifying the file register, specify the data register (D).

Device (Device Name)		Access Target							
		A1N	A0J2H A1S(-S1) A1SH(-S1) A1SJH A1SJ A2C(J) A2N(-S1) A2S(-S1) A2SH(-S1) A1FX	A2A(-S1) A2U(-S1) A2US(-S1) A2AS (-S1/-S30) A2USH-S1 Q02(H)-A Q06H-A	A3N A3A A3U	A4U	Q2A(-S1) Q3A Q4A Q4AR Q2AS(-S1) Q2ASH(-S1) Q02(H) Q06H Q12H Q25H	FX <sub>0</sub> FX <sub>0S</sub> FX <sub>0N</sub> FX <sub>1</sub> FX <sub>1N</sub> FX <sub>1S</sub> FX <sub>2</sub> FX <sub>2C</sub> FX <sub>2N</sub> FX <sub>2NC</sub>	A273UH(-S3) A171SH A172SH A173UH (-S1)
Direct link	Link input (J*\X)	×	×	×	×	×	○	×	×
	Link output (J*\Y)	×	×	×	×	×	○	×	×
	Link relay (J*\B)	×	×	×	×	×	○	×	×
	Link special relay (J*\SB)	×	×	×	×	×	○	×	×
	Link register (J*\W)	×	×	×	×	×	○	×	×
	Link special register (J*\SW)	×	×	×	×	×	○	×	×
Special direct buffer memory (U*\G)		×	×	×	×	×	○	×	×

8.4.2 Accessible ranges

This section indicates the accessible ranges for CPU COM communication.

(1) Configuration

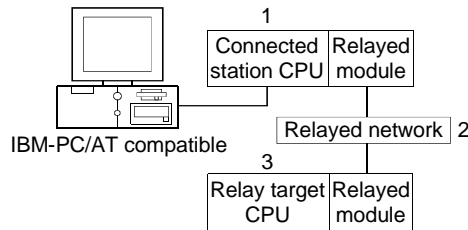

(2) Accessibility list

The following table indicates whether access can be made or not.

The connected station CPUs are all accessible.

Whether the relay target CPU is accessible or not is indicated by ○ (accessible) or × (inaccessible).

1. Connected Station CPU (Usable control name)	2. Relayed Network	3. Relay Target CPU					
		QCPU		QnACPU	ACPU	FXCPU	Motion controller CPU
		Q mode	A mode				
QCPU(Q mode) (ActQCPUQ)	MELSECNET/10H	○	×	×	×	×	×
	MELSECNET/10	○	○	○	○	×	○
	MELSECNET(II)	×	×	×	×	×	×
	Ethernet	○ *1	×	○ *1	×	×	×
	Computer link	○	×	○	×	×	×
	CC-Link	○	○ *2	○ *2	○ *2	×	○ *2
QCPU(A mode) (ActQCPUA)	MELSECNET/10H	×	×	×	×	×	×
	MELSECNET/10	×	○	×	○	×	○
	MELSECNET(II)	×	○	×	○	×	○
	Ethernet	×	×	×	×	×	×
	Computer link	×	×	×	×	×	×
	CC-Link	×	×	×	×	×	×
QnACPU (ActQnACPU)	MELSECNET/10H	×	×	×	×	×	×
	MELSECNET/10	×	×	○	×	×	×
	MELSECNET(II)	×	×	○	×	×	×
	Ethernet	×	×	○ *1	×	×	×
	Computer link	×	×	○	×	×	×
	CC-Link	×	×	×	×	×	×

\* 1: Set the parameter-set values of the target station side Q series-compatible E71 or QE71 to the network number and station number. Also set the "MNET/10 routing information" of the Q series-compatible E71 or QE71 parameter setting. At that time, specify any of the IP address calculation system, table conversion system and combined system as the "MNET/10 routing system".

\* 2: As the relayed station CPU side CC-Link system master/local module, use the module of software version "S" or later.

1. Connected Station CPU (Usable control name)	2. Relayed Network	3. Relay Target CPU					
		QCPU		QnACPU	ACPU	FXCPU	Motion controller CPU
		Q mode	A mode				
ACPU, Motion controller CPU (ActACPU)	MELSECNET/10H	×	×	×	×	×	×
	MELSECNET/10	×	○	×	○	×	○
	MELSECNET(II)	×	○	×	○	×	○
	Ethernet	×	×	×	×	×	×
	Computer link	×	×	×	×	×	×
	CC-Link	×	×	×	×	×	×
FXCPU (ActFXCPU)	MELSECNET/10H	×	×	×	×	×	×
	MELSECNET/10	×	×	×	×	×	×
	MELSECNET(II)	×	×	×	×	×	×
	Ethernet	×	×	×	×	×	×
	Computer link	×	×	×	×	×	×
	CC-Link	×	×	×	×	×	×

8.5 For CPU USB Communication

This section provides the accessible devices and accessible ranges for CPU USB communication.

8.5.1 Accessible devices

The following table indicates the accessible devices for CPU USB communication.

Device (Device Name)	Access Target							
	A1N	A0J2H A1S(-S1) A1SH(-S1) A1SJH A1SJ A2C(J) A2N(-S1) A2S(-S1) A2SH(-S1) A1FX	A2A(-S1) A2U(-S1) A2US(-S1) A2AS (-S1/-S30) A2USH-S1 Q02(H)-A Q06H-A	A3N A3A A3U	A4U	Q2A(-S1) Q3A Q4A Q4AR Q2AS(-S1) Q2ASH(-S1) Q02(H) Q06H Q12H Q25H	FX <sub>0</sub> FX <sub>0S</sub> FX <sub>0N</sub> FX <sub>1</sub> FX <sub>1N</sub> FX <sub>1S</sub> FX <sub>2</sub> FX <sub>2C</sub> FX <sub>2N</sub> FX <sub>2NC</sub>	A273UH(-S3) A171SH A172SH A173UH (-S1)
Function input (FX)	×	×	×	×	×	○	×	×
Function output (FY)	×	×	×	×	×	○	×	×
Function register (FD)	×	×	×	×	×	○	×	×
Special relay (SM)	○	○	○	○	○	○	×	○
Special register (SD)	○	○	○	○	○	○	×	○
Input relay (X)	○	○	○	○	○	○	×	○
Output relay (Y)	○	○	○	○	○	○	×	○
Internal relay (M)	○	○	○	○	○	○	×	○
Latch relay (L)	○	○	○	○	○	○	×	○
Annunciator (F)	○	○	○	○	○	○	×	○
Edge relay (V)	×	×	×	×	×	○	×	×
Link relay (B)	○	○	○	○	○	○	×	○
Data register (D)	○	○	○	○	○	○	×	○
Link register (W)	○	○	○	○	○	○	×	○
Timer	Contact (TS)	○	○	○	○	○	×	○
	Coil (TC)	○	○	○	○	○	×	○
	Present value (TN)	○	○	○	○	○	×	○
Counter	Contact (CS)	○	○	○	○	○	×	○
	Coil (CC)	○	○	○	○	○	×	○
	Present value (CN)	○	○	○	○	○	×	○
Retentive timer	Contact (SS)	×	×	×	×	○	×	×
	Coil (SC)	×	×	×	×	○	×	×
	Present value (SN)	×	×	×	×	○	×	×
Link special relay (SB)	×	×	×	×	×	○	×	×
Link special register (SW)	×	×	×	×	×	○	×	×
Step relay (S)	○	○	○	○	○	×	×	○
Direct input (DX)	×	×	×	×	×	×	×	×
Direct output (DY)	×	×	×	×	×	×	×	×
Accumulator (A)	○	○	○	○	○	×	×	○
Index register	(Z)	○	○	○	○	○	×	○
	(V)	○	○	○	○	○	×	○
File register	(R)	○	○	○	○	○	×	○
	(ZR)	×	×	×	×	○	×	×
Extended file register (ER * \R)	○	○	○	○	○	×	×	○

Device (Device Name)		Access Target							
		A1N	A0J2H A1S(-S1) A1SH(-S1) A1SJH A1SJ A2C(J) A2N(-S1) A2S(-S1) A2SH(-S1) A1FX	A2A(-S1) A2U(-S1) A2US(-S1) A2AS (-S1/-S30) A2USH-S1 Q02(H)-A Q06H-A	A3N A3A A3U	A4U	Q2A(-S1) Q3A Q4A Q4AR Q2AS(-S1) Q2ASH(-S1) Q02(H) Q06H Q12H Q25H	FX <sub>0</sub> FX <sub>0S</sub> FX <sub>0N</sub> FX <sub>1</sub> FX <sub>1N</sub> FX <sub>1S</sub> FX <sub>2</sub> FX <sub>2C</sub> FX <sub>2N</sub> FX <sub>2NC</sub>	A273UH(-S3) A171SH A172SH A173UH (-S1)
Direct link	Link input (J*\X)	×	×	×	×	×	○	×	×
	Link output (J*\Y)	×	×	×	×	×	○	×	×
	Link relay (J*\B)	×	×	×	×	×	○	×	×
	Link special relay (J*\SB)	×	×	×	×	×	○	×	×
	Link register (J*\W)	×	×	×	×	×	○	×	×
	Link special register (J*\SW)	×	×	×	×	×	○	×	×
Special direct buffer memory (U*\G)		×	×	×	×	×	○	×	×



8.5.2 Accessible ranges

This section indicates the accessible ranges for CPU USB communication.

(1) Configuration

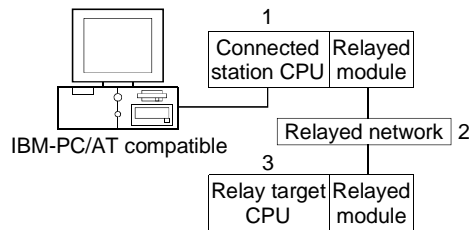

(2) Accessibility list

The following table indicates whether access can be made or not.

The connected station CPUs are all accessible.

Whether the relay target CPU is accessible or not is indicated by ○ (accessible) or × (inaccessible).

1. Connected Station CPU (Usable control name)	2. Relayed Network	3. Relay Target CPU					
		QCPU		QnACPU	ACPU	FXCPU	Motion controller CPU
		Q mode	A mode				
QCPU(Q mode) (ActQCPUQUSB)	MELSECNET/10H	○	×	×	×	×	×
	MELSECNET/10	○	○	○	○	×	○
	MELSECNET(II)	×	×	×	×	×	×
	Ethernet	○ *1	×	○ *1	×	×	×
	Computer link	○	×	○	×	×	×
	CC-Link	○	○ *2	○ *2	○ *2	×	○ *2

\*1: Set the parameter-set values of the target station side Q series-compatible E71 or QE71 to the network number and station number. Also set the "MNET/10 routing information" of the Q series-compatible E71 or QE71 parameter setting. At that time, specify any of the IP address calculation system, table conversion system and combined system as the "MNET/10 routing system".

\*2: As the relayed station CPU side CC-Link system master/local module, use the module of software version "S" or later.

8.6 For MELSECNET/10 Communication

This section provides the accessible devices and accessible ranges for MELSECNET/10 communication.

8.6.1 Accessible devices

The following table indicates the accessible devices for MELSECNET/10 communication.

Device (Device Name)	Access Target								
	A1N	A0J2H A1S(-S1) A1SH(-S1) A1SJH A1SJ A2C(J) A2N(-S1) A2S(-S1) A2SH (-S1) A1FX	A2A(-S1) A2U(-S1) A2US (-S1) A2AS (-S1/-S30) A2USH- S1 Q02(H)-A Q06H-A	A3N A3A A3U	A4U	Q2A(-S1) Q3A Q4A Q4AR Q2AS(-S1) Q2ASH (-S1) Q02(H) Q06H Q12H Q25H	FX <sub>0</sub> FX <sub>0S</sub> FX <sub>0N</sub> FX <sub>1</sub> FX <sub>1N</sub> FX <sub>1S</sub> FX <sub>2</sub> FX <sub>2C</sub> FX <sub>2N</sub> FX <sub>2NC</sub>	A273UH (-S3) A171SH A172SH A173UH (-S1)	Own board
Function input (FX)	×	×	×	×	×	○ *1	×	×	×
Function output (FY)	×	×	×	×	×	○ *1	×	×	×
Function register (FD)	×	×	×	×	×	○ *1	×	×	×
Special relay (SM)	○	○	○	○	○	○ *1	×	○	○
Special register (SD)	○	○	○	○	○	○ *1	×	○	○
Input relay (X)	○	○	○	○	○	○ *1	×	○	○
Output relay (Y)	○	○	○	○	○	○ *1	×	○	○
Internal relay (M)	○	○	○	○	○	○ *1	×	○	×
Latch relay (L)	○	○	○	○	○	○ *1	×	○	×
Annunciator (F)	○	○	○	○	○	○ *1	×	○	×
Edge relay (V)	×	×	×	×	×	○ *1	×	×	×
Link relay (B)	○	○	○	○	○	○ *1	×	○	○
Data register (D)	○	○	○	○	○	○ *1	×	○	×
Link register (W)	○	○	○	○	○	○ *1	×	○	○
Timer	Contact (TS)	○	○	○	○	○ *1	×	○	×
	Coil (TC)	○	○	○	○	○ *1	×	○	×
	Present value (TN)	○	○	○	○	○ *1	×	○	×
Counter	Contact (CS)	○	○	○	○	○ *1	×	○	×
	Coil (CC)	○	○	○	○	○ *1	×	○	×
	Present value (CN)	○	○	○	○	○ *1	×	○	×
Retentive timer	Contact (SS)	×	×	×	×	○ *1	×	×	×
	Coil (SC)	×	×	×	×	○ *1	×	×	×
	Present value (SN)	×	×	×	×	○ *1	×	×	×
Link special relay (SB)	×	×	×	×	×	○ *1	×	○	
Link special register (SW)	×	×	×	×	×	○ *1	×	○	
Step relay (S)	○	○	○	○	○	×	×	○	×
Direct input (DX)	×	×	×	×	×	×	×	×	×
Direct output (DY)	×	×	×	×	×	×	×	×	×
Accumulator (A)	○	○	○	○	○	×	×	○	×
Index register	(Z)	○	○	○	○	○ *1	×	○	×
	(V)	○	○	○	○	×	×	○	×
File register	(R)	○	○	○	○	○ *1	×	○	×
	(ZR)	×	×	×	×	○ *1	×	×	×
Extended file register (ER *R)	○	○	○	○	○	×	×	○	×

\*1: Access to QCPU (Q mode) cannot be made.

Device (Device Name)		Access Target								
		A1N	A0J2H A1S(-S1) A1SH(-S1) A1SJH A1SJ A2C(J) A2N(-S1) A2S(-S1) A2SH (-S1) A1FX	A2A(-S1) A2U(-S1) A2US (-S1) A2AS (-S1/-S30) A2USH- S1 Q02(H)-A Q06H-A	A3N A3A A3U	A4U	Q2A(-S1) Q3A Q4A Q4AR Q2AS(-S1) Q2ASH (-S1) Q02(H) Q06H Q12H Q25H	FX <sub>0</sub> FX <sub>0S</sub> FX <sub>0N</sub> FX <sub>1</sub> FX <sub>1N</sub> FX <sub>1S</sub> FX <sub>2</sub> FX <sub>2C</sub> FX <sub>2N</sub> FX <sub>2NC</sub>	A273UH (-S3) A171SH A172SH A173UH (-S1)	Own board
Direct link	Link input (J*\X)	×	×	×	×	×	○ *1	×	×	×
	Link output (J*\Y)	×	×	×	×	×	○ *1	×	×	×
	Link relay (J*\B)	×	×	×	×	×	○ *1	×	×	×
	Link special relay (J*\SB)	×	×	×	×	×	○ *1	×	×	×
	Link register (J*\W)	×	×	×	×	×	○ *1	×	×	×
	Link special register (J*\SW)	×	×	×	×	×	○ *1	×	×	×
Special direct buffer memory (U*\G)		×	×	×	×	×	○ *1	×	×	×

\* 1: Access to QCPU (Q mode) cannot be made.

8.6.2 Accessible ranges

This section indicates the accessible ranges for MELSECNET/10 communication.

(1) Configuration

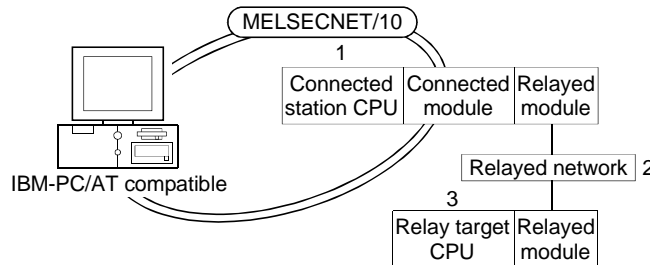

(2) Accessibility list

The following table indicates whether access can be made or not.

The connected station CPUs and own board (MELSECNET/10 board) are all accessible.

Whether the relay target CPU is accessible or not is indicated by ○ (accessible) or × (inaccessible).

1. Connected Station CPU (Usable control name)	2. Relayed Network	3. Relay Target CPU					
		QCPU		QnACPU	ACPU	FXCPU	Motion controller CPU
		Q mode	A mode				
QCPU(Q mode) (ActMnet10BD)	MELSECNET/10H	×	×	×	×	×	×
	MELSECNET/10	○	○	○	○	×	○
	MELSECNET(II)	×	×	×	×	×	×
	Ethernet	○	×	×	×	×	×
	Computer link	○	×	×	×	×	×
	CC-Link	○	×	×	×	×	×
QnACPU * 1, (ActMnet10BD)	MELSECNET/10H	×	×	×	×	×	×
	MELSECNET/10	○	○	○	○	×	○
	MELSECNET(II)	×	×	×	×	×	×
	Ethernet	×	×	○	×	×	×
	Computer link	×	×	○	×	×	×
	CC-Link	×	×	×	×	×	×
QCPU(A mode), ACPU, Motion controller CPU (ActMnet10BD)	MELSECNET/10H	×	×	×	×	×	×
	MELSECNET/10	○	○	○	○	×	○
	MELSECNET(II)	×	×	×	×	×	×
	Ethernet	×	×	×	×	×	×
	Computer link	×	×	×	×	×	×
	CC-Link	×	×	×	×	×	×

\* 1: Operates as the one equivalent to AnACPU.

8.7 For CC-Link Communication

This section provides the accessible devices and accessible ranges for CC-Link communication.

8.7.1 Accessible devices

The following table indicates the accessible devices for CC-Link communication.

(1) For another station access

Device (Device Name)	Access Target							
	A1N	A0J2H A1S(-S1) A1SH(-S1) A1SJH A1SJ A2C(J) A2N(-S1) A2S(-S1) A2SH(-S1) A1FX	A2A(-S1) A2U(-S1) A2US(-S1) A2AS (-S1/-S30) A2USH-S1 Q02(H)-A Q06H-A	A3N A3A A3U	A4U	Q2A(-S1) Q3A Q4A Q4AR Q2AS(-S1) Q2ASH(-S1) Q02(H) Q06H Q12H Q25H	FX <sub>0</sub> FX <sub>0S</sub> FX <sub>0N</sub> FX <sub>1</sub> FX <sub>1N</sub> FX <sub>1S</sub> FX <sub>2</sub> FX <sub>2C</sub> FX <sub>2N</sub> FX <sub>2NC</sub>	A273UH(-S3) A171SH A172SH A173UH (-S1)
Function input (FX)	×	×	×	×	×	○	×	×
Function output (FY)	×	×	×	×	×	○	×	×
Function register (FD)	×	×	×	×	×	○	×	×
Special relay (SM)	○	○	○	○	○	○	×	○
Special register (SD)	○	○	○	○	○	○	×	○
Input relay (X)	○	○	○	○	○	○	×	○
Output relay (Y)	○	○	○	○	○	○	×	○
Internal relay (M)	○	○	○	○	○	○	×	○
Latch relay (L)	○	○	○	○	○	○	×	○
Annunciator (F)	○	○	○	○	○	○	×	○
Edge relay (V)	×	×	×	×	×	○	×	×
Link relay (B)	○	○	○	○	○	○	×	○
Data register (D)	○	○	○	○	○	○	×	○
Link register (W)	○	○	○	○	○	○	×	○
Timer	Contact (TS)	○	○	○	○	○	×	○
	Coil (TC)	○	○	○	○	○	×	○
	Present value (TN)	○	○	○	○	○	×	○
Counter	Contact (CS)	○	○	○	○	○	×	○
	Coil (CC)	○	○	○	○	○	×	○
	Present value (CN)	○	○	○	○	○	×	○
Retentive timer	Contact (SS)	×	×	×	×	○	×	×
	Coil (SC)	×	×	×	×	○	×	×
	Present value (SN)	×	×	×	×	○	×	×
Link special relay (SB)	×	×	×	×	×	○	×	×
Link special register (SW)	×	×	×	×	×	○	×	×
Step relay (S)	○	○	○	○	○	×	×	○
Direct input (DX)	×	×	×	×	×	×	×	×
Direct output (DY)	×	×	×	×	×	×	×	×
Accumulator (A)	○	○	○	○	○	×	×	○
Index register	(Z)	○	○	○	○	○	×	○
	(V)	○	○	○	○	○	×	○
File register	(R)	○	○	○	○	○	×	○
	(ZR)	×	×	×	×	○	×	×
Extended file register (ER * \R)	○	○	○	○	○	×	×	○

Device (Device Name)		Access Target							
		A1N	A0J2H A1S(-S1) A1SH(-S1) A1SJH A1SJ A2C(J) A2N(-S1) A2S(-S1) A2SH(-S1) A1FX	A2A(-S1) A2U(-S1) A2US(-S1) A2AS (-S1/-S30) A2USH-S1 Q02(H)-A Q06H-A	A3N A3A A3U	A4U	Q2A(-S1) Q3A Q4A Q4AR Q2AS(-S1) Q2ASH(-S1) Q02(H) Q06H Q12H Q25H	FX <sub>0</sub> FX <sub>0S</sub> FX <sub>0N</sub> FX <sub>1</sub> FX <sub>1N</sub> FX <sub>1S</sub> FX <sub>2</sub> FX <sub>2C</sub> FX <sub>2N</sub> FX <sub>2NC</sub>	A273UH(-S3) A171SH A172SH A173UH (-S1)
Direct link	Link input (J*\X)	×	×	×	×	×	○	×	×
	Link output (J*\Y)	×	×	×	×	×	○	×	×
	Link relay (J*\B)	×	×	×	×	×	○	×	×
	Link special relay (J*\SB)	×	×	×	×	×	○	×	×
	Link register (J*\W)	×	×	×	×	×	○	×	×
	Link special register (J*\SW)	×	×	×	×	×	○	×	×
Special direct buffer memory (U*\G)	×	×	×	×	×	○	×	×	

(2) For own board access

The following devices are usable only for own board access.

Device	Device Name	Remarks
Special relay	SM	Special relay of own board
Special register	SD	Special register of own board
Link special relay (for CC-Link)	SB	Link special relay of own board
Link special register (for CC-Link)	SW	Link special register of own board
Remote input	X	RX
Remote output	Y	RY
Link register	W	—
Remote register (write area for CC-Link)	WW	RWw
Remote register (read area for CC-Link)	WR	RWr
Buffer memory	ML	Buffer memory of own station CC-Link module
Random access buffer	MC	Random access buffer in buffer memory of own station CC-Link module
Automatic refresh buffer	MF	Automatic refresh buffer of own station CC-Link module

8.7.2 Accessible ranges

This section indicates the accessible ranges for CC-Link communication.

(1) Configuration

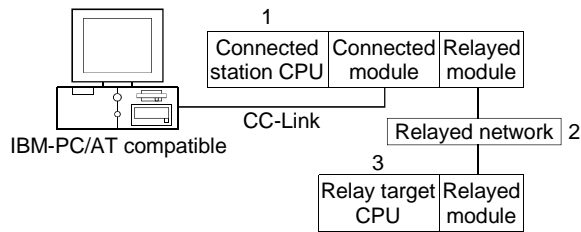

(2) Accessibility list

The following table indicates whether access can be made or not.

The connected station CPUs and own board (CC-Link board) are all accessible. Whether the relay target CPU is accessible or not is indicated by ○ (accessible) or × (inaccessible).

1. Connected Station CPU (Usable control name)	2. Relayed Network	3. Relay Target CPU					
		QCPU		QnACPU	ACPU	FXCPU	Motion controller CPU
		Q mode	A mode				
QCPU(Q mode), (ActCCBD)	MELSECNET/10H	○	×	×	×	×	×
	MELSECNET/10	○	×	×	×	×	×
	MELSECNET(II)	×	×	×	×	×	×
	Ethernet	○	×	×	×	×	×
	Computer link	×	×	×	×	×	×
	CC-Link	×	×	×	×	×	×
QnACPU (ActCCBD)	MELSECNET/10H	×	×	×	×	×	×
	MELSECNET/10	×	×	○	×	×	×
	MELSECNET(II)	×	×	×	×	×	×
	Ethernet	×	×	○	×	×	×
	Computer link	×	×	×	×	×	×
	CC-Link	×	×	×	×	×	×
QCPU(A mode), ACPU, Motion controller CPU (ActCCBD)	MELSECNET/10H	×	×	×	×	×	×
	MELSECNET/10	×	×	×	×	×	×
	MELSECNET(II)	×	×	×	×	×	×
	Ethernet	×	×	×	×	×	×
	Computer link	×	×	×	×	×	×
	CC-Link	×	×	×	×	×	×

8.8 For CC-Link G4 Communication

This section provides the accessible devices and accessible ranges for CC-Link G4 communication.

8.8.1 Accessible devices

The following table indicates the accessible devices for CC-Link G4 communication.

Device (Device Name)	Access Target							
	A1N	A0J2H A1S(-S1) A1SH(-S1) A1SJH A1SJ A2C(J) A2N(-S1) A2S(-S1) A2SH(-S1) A1FX	A2A(-S1) A2U(-S1) A2US(-S1) A2AS (-S1/-S30) A2USH-S1 Q02(H)-A Q06H-A	A3N A3A A3U	A4U	Q2A(-S1) Q3A Q4A Q4AR Q2AS(-S1) Q2ASH(-S1) Q02(H) Q06H Q12H Q25H	FX <sub>0</sub> FX <sub>0S</sub> FX <sub>0N</sub> FX <sub>1</sub> FX <sub>1N</sub> FX <sub>1S</sub> FX <sub>2</sub> FX <sub>2C</sub> FX <sub>2N</sub> FX <sub>2NC</sub>	A273UH(-S3) A171SH A172SH A173UH (-S1)
Function input (FX)	×	×	×	×	×	○ *1	×	×
Function output (FY)	×	×	×	×	×	○ *1	×	×
Function register (FD)	×	×	×	×	×	○ *1	×	×
Special relay (SM)	○	○	○	○	○	○ *1	×	○
Special register (SD)	○	○	○	○	○	○ *1	×	○
Input relay (X)	○	○	○	○	○	○ *1	×	○
Output relay (Y)	○	○	○	○	○	○ *1	×	○
Internal relay (M)	○	○	○	○	○	○ *1	×	○
Latch relay (L)	○	○	○	○	○	○ *1	×	○
Annunciator (F)	○	○	○	○	○	○ *1	×	○
Edge relay (V)	×	×	×	×	×	○ *1	×	×
Link relay (B)	○	○	○	○	○	○ *1	×	○
Data register (D)	○	○	○	○	○	○ *1	×	○
Link register (W)	○	○	○	○	○	○ *1	×	○
Timer	Contact (TS)	○	○	○	○	○ *1	×	○
	Coil (TC)	○	○	○	○	○ *1	×	○
	Present value (TN)	○	○	○	○	○ *1	×	○
Counter	Contact (CS)	○	○	○	○	○ *1	×	○
	Coil (CC)	○	○	○	○	○ *1	×	○
	Present value (CN)	○	○	○	○	○ *1	×	○
Retentive timer	Contact (SS)	×	×	×	×	○ *1	×	×
	Coil (SC)	×	×	×	×	○ *1	×	×
	Present value (SN)	×	×	×	×	○ *1	×	×
Link special relay (SB)	×	×	×	×	×	○ *1	×	×
Link special register (SW)	×	×	×	×	×	○ *1	×	×
Step relay (S)	○	○	○	○	○	×	×	○
Direct input (DX)	×	×	×	×	×	×	×	×
Direct output (DY)	×	×	×	×	×	×	×	×
Accumulator (A)	○	○	○	○	○	×	×	○
Index register	(Z)	○	○	○	○	○ *1	×	○
	(V)	○	○	○	○	×	×	○
File register	(R)	○	○	○	○	○ *1	×	○
	(ZR)	×	×	×	×	○ *1	×	×
Extended file register (ER*1R)	○	○	○	○	○	×	×	○

\*1: Access to QCPU (Q mode) cannot be made.



Device (Device Name)		Access Target							
		A1N	A0J2H A1S(-S1) A1SH(-S1) A1SJH A1SJ A2C(J) A2N(-S1) A2S(-S1) A2SH(-S1) A1FX	A2A(-S1) A2U(-S1) A2US(-S1) A2AS (-S1/-S30) A2USH-S1 Q02(H)-A Q06H-A	A3N A3A A3U	A4U	Q2A(-S1) Q3A Q4A Q4AR Q2AS(-S1) Q2ASH(-S1) Q02(H) Q06H Q12H Q25H	FX <sub>0</sub> FX <sub>0S</sub> FX <sub>0N</sub> FX <sub>1</sub> FX <sub>1N</sub> FX <sub>1S</sub> FX <sub>2</sub> FX <sub>2C</sub> FX <sub>2N</sub> FX <sub>2NC</sub>	A273UH(-S3) A171SH A172SH A173UH (-S1)
Direct link	Link input (J*\X)	×	×	×	×	×	○ *1	×	×
	Link output (J*\Y)	×	×	×	×	×	○ *1	×	×
	Link relay (J*\B)	×	×	×	×	×	○ *1	×	×
	Link special relay (J*\SB)	×	×	×	×	×	○ *1	×	×
	Link register (J*\W)	×	×	×	×	×	○ *1	×	×
	Link special register (J*\SW)	×	×	×	×	×	○ *1	×	×
Special direct buffer memory (U*\G)		×	×	×	×	×	○ *1	×	×

\* 1: Access to QCPU (Q mode) cannot be made.

8.8.2 Accessible ranges

This section indicates the accessible ranges for CC-Link G4 communication.

(1) Configuration

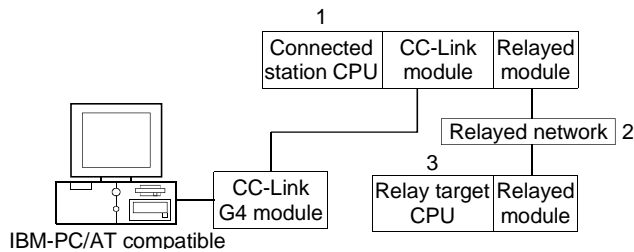

(2) Accessibility list

The following table indicates whether access can be made or not.

The connected station CPUs and own board (CC-Link board) are all accessible. Whether the relay target CPU is accessible or not is indicated by ○ (accessible) or × (inaccessible).

(a) When CC-Link G module is in QnA mode

1. Connected Station CPU (Usable control name)	2. Relayed Network	3. Relay Target CPU					
		QCPU		QnACPU	ACPU	FXCPU	Motion controller CPU
		Q mode	A mode				
QnACPU (ActCCG4QnA)	MELSECNET/10H	×	×	×	×	×	×
	MELSECNET/10	×	×	○	×	×	×
	MELSECNET(II)	×	×	○	×	×	×
	Ethernet	×	×	○	×	×	×
	Computer link	×	×	○	×	×	×
	CC-Link	×	×	×	×	×	×

(b) When CC-Link G module is in A mode

1. Connected Station CPU (Usable control name)	2. Relayed Network	3. Relay Target CPU					
		QCPU		QnACPU	ACPU	FXCPU	Motion controller CPU
		Q mode	A mode				
QCPU(A mode), ACPU, Motion controller CPU (ActCCG4A)	MELSECNET/10H	×	×	×	×	×	×
	MELSECNET/10	×	×	×	×	×	×
	MELSECNET(II)	×	×	×	×	×	×
	Ethernet	×	×	×	×	×	×
	Computer link	×	×	×	×	×	×
	CC-Link	×	×	×	×	×	×

8.9 For CPU Board Communication

This section provides the accessible devices and accessible ranges for CPU board communication.

8.9.1 Accessible devices

The following table indicates the accessible devices for CPU board communication.

Device (Device Name)	Access Target							
	A1N	A0J2H A1S(-S1) A1SH(-S1) A1SJH A1SJ A2C(J) A2N(-S1) A2S(-S1) A2SH(-S1) A1FX	A2A(-S1) A2U(-S1) A2US(-S1) A2AS (-S1/-S30) A2USH-S1 Q02(H)-A Q06H-A	A3N A3A A3U	A4U	Q2A(-S1) Q3A Q4A Q4AR Q2AS(-S1) Q2ASH(-S1) Q02(H) Q06H Q12H Q25H	FX <sub>0</sub> FX <sub>0S</sub> FX <sub>0N</sub> FX <sub>1</sub> FX <sub>1N</sub> FX <sub>1S</sub> FX <sub>2</sub> FX <sub>2C</sub> FX <sub>2N</sub> FX <sub>2NC</sub>	A273UH(-S3) A171SH A172SH A173UH (-S1)
Function input (FX)	×	×	×	×	×	○ *1	×	×
Function output (FY)	×	×	×	×	×	○ *1	×	×
Function register (FD)	×	×	×	×	×	○ *1	×	×
Special relay (SM)	○	○	○	○	○	○ *1	×	○
Special register (SD)	○	○	○	○	○	○ *1	×	○
Input relay (X)	○	○	○	○	○	○ *1	×	○
Output relay (Y)	○	○	○	○	○	○ *1	×	○
Internal relay (M)	○	○	○	○	○	○ *1	×	○
Latch relay (L)	○	○	○	○	○	○ *1	×	○
Annunciator (F)	○	○	○	○	○	○ *1	×	○
Edge relay (V)	×	×	×	×	×	○ *1	×	×
Link relay (B)	○	○	○	○	○	○ *1	×	○
Data register (D)	○	○	○	○	○	○ *1	×	○
Link register (W)	○	○	○	○	○	○ *1	×	○
Timer	Contact (TS)	○	○	○	○	○ *1	×	○
	Coil (TC)	○	○	○	○	○ *1	×	○
	Present value (TN)	○	○	○	○	○ *1	×	○
Counter	Contact (CS)	○	○	○	○	○ *1	×	○
	Coil (CC)	○	○	○	○	○ *1	×	○
	Present value (CN)	○	○	○	○	○ *1	×	○
Retentive timer	Contact (SS)	×	×	×	×	○ *1	×	×
	Coil (SC)	×	×	×	×	○ *1	×	×
	Present value (SN)	×	×	×	×	○ *1	×	×
Link special relay (SB)	×	×	×	×	×	○ *1	×	×
Link special register (SW)	×	×	×	×	×	○ *1	×	×
Step relay (S)	○	○	○	○	○	×	×	○
Direct input (DX)	×	×	×	×	×	×	×	×
Direct output (DY)	×	×	×	×	×	×	×	×
Accumulator (A)	○	○	○	○	○	×	×	○
Index register	(Z)	○	○	○	○	○ *1	×	○
	(V)	○	○	○	○	×	×	○
File register	(R)	○	○	○	○	○ *1	×	○
	(ZR)	×	×	×	×	○ *1	×	×
Extended file register (ER *R)	○	○	○	○	○	×	×	○

\* 1: Access to QCPU (Q mode) cannot be made.

When making access to QnACPU, the range is equivalent to that of AnACPU.

Device (Device Name)		Access Target							
		A1N	A0J2H A1S(-S1) A1SH(-S1) A1SJH A1SJ A2C(J) A2N(-S1) A2S(-S1) A2SH(-S1) A1FX	A2A(-S1) A2U(-S1) A2US(-S1) A2AS (-S1/-S30) A2USH-S1 Q02(H)-A Q06H-A	A3N A3A A3U	A4U	Q2A(-S1) Q3A Q4A Q4AR Q2AS(-S1) Q2ASH(-S1) Q02(H) Q06H Q12H Q25H	FX <sub>0</sub> FX <sub>0S</sub> FX <sub>0N</sub> FX <sub>1</sub> FX <sub>1N</sub> FX <sub>1S</sub> FX <sub>2</sub> FX <sub>2C</sub> FX <sub>2N</sub> FX <sub>2NC</sub>	A273UH(-S3) A171SH A172SH A173UH (-S1)
Direct link	Link input (J*\X)	×	×	×	×	×	○ *1	×	×
	Link output (J*\Y)	×	×	×	×	×	○ *1	×	×
	Link relay (J*\B)	×	×	×	×	×	○ *1	×	×
	Link special relay (J*\SB)	×	×	×	×	×	○ *1	×	×
	Link register (J*\W)	×	×	×	×	×	○ *1	×	×
	Link special register (J*\SW)	×	×	×	×	×	○ *1	×	×
Special direct buffer memory (U*\G)		×	×	×	×	×	○ *1	×	×

\* 1: Access to QCPU (Q mode) cannot be made.

When making access to QnACPU, the range is equivalent to that of AnACPU.

8.9.2 Accessible ranges

This section indicates the accessible ranges for CPU board communication.

(1) Configuration

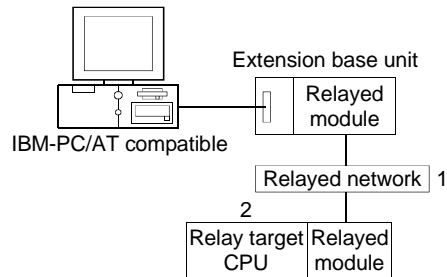

(2) Accessibility list

The following table indicates whether access can be made or not.

The own board (CPU board) is accessible.

Whether the relay target CPU is accessible or not is indicated by ○ (accessible) or × (inaccessible).

Network Board	1. Relayed Network	3. Relay Target CPU					
		QCPU		QnACPU	ACPU	FXCPU	Motion controller CPU
		Q mode	A mode				
CPU board (ActAnUBD)	MELSECNET/10H	×	×	×	×	×	×
	MELSECNET/10	×	○	○ *1	○	×	○
	MELSECNET(II)	×	○	○ *1	○	×	○
	Ethernet	×	×	×	×	×	×
	Computer link	×	×	×	×	×	×
	CC-Link	×	×	×	×	×	×

\* 1: Operates as the one equivalent to AnACPU.

Appendix 1 Concept of the Routing Parameters

The routing function is used by the station of the PLC in a multi-level system to make transient transmission to the station of another network No.

To perform the routing function, the "Routing parameters" must be set to associate the network No.s and stations acting as bridges.

For communication via the MELSECNET II, the routing function cannot be used.

- (1) The routing parameters must be set to the request source and relay station of the PLC.
  - (a) The request source must be set to make access to the request target.
  - (b) The relay station must be set to make access from the request source to the request target and to make access from the request target to the request source.
  - (c) The request target needs no setting.

For example, to make transient transmission from 1Ns3 to 3Ns4 in the following diagram, the routing parameters must be set to the PLC 1Ns3 which makes transient transmission, to the PLCs 1Ns4 and 2Mp1 which serve as bridges, and to the PLCs 2Ns4 and 3Ns5.

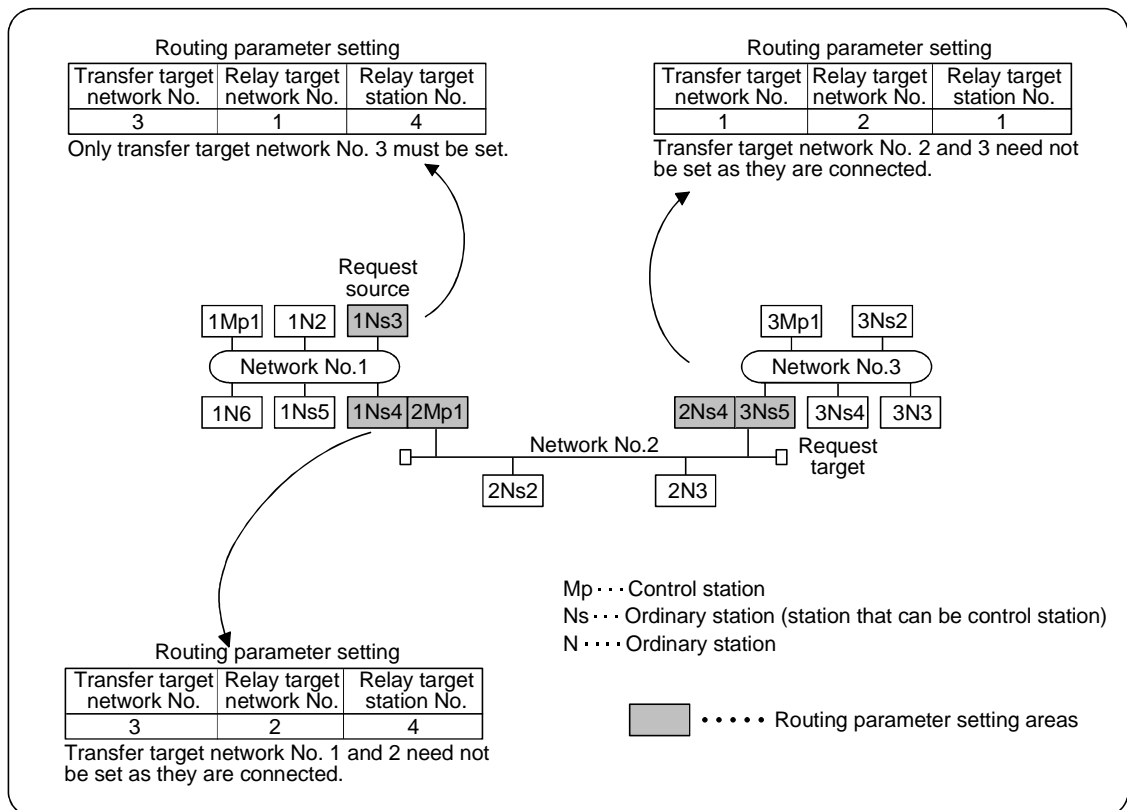

- (2) Up to 16 "transfer target network No.s" can be set to the PLC. 16 different network No.s allow the own station to be a request source or other stations to be accessed via the own station.

(3) Routing parameter setting areas and data

For transient transmission, the routing parameter setting areas depend on the system.

(a) Two-level system

The routing parameters need not be set because transient transmission is made to within the same network.

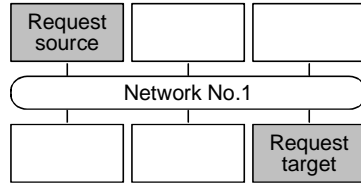

(b) Multi-level 1 (two networks)

Set the routing parameters only to the station of the request source. To the request source, set the data to access the request target (network No. 2).

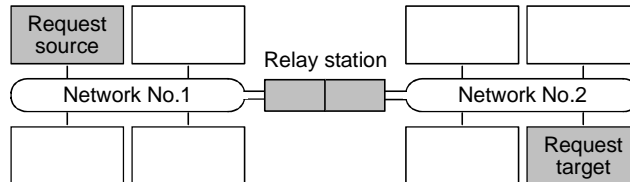

(c) Multi-level 2 (three networks)

Set the routing parameters to the request source and relay stations. To the request source, set the data to access the request target (network No. 3). To the relay station 1), set the data to access the request target (network No. 3). To the relay station 2), set the data to access the request source (network No. 1).

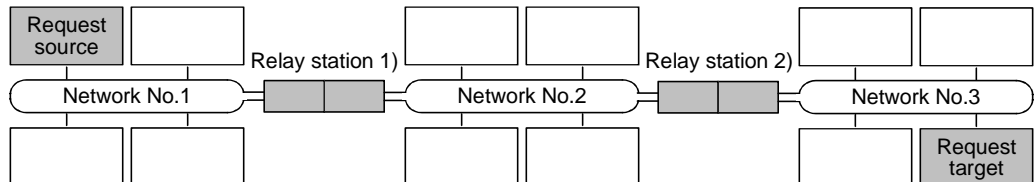

(d) Multi-level 3 (four or more networks)

Set the routing parameters to the request source and relay stations. To the request source, set the data to access the request target (network No. 4). To the relay station 1) (the nearest relay station to the request source), set the data to access the request target (network No. 4). To the relay station 2) (the nearest relay station to the request target), set the data to access the request source (network No. 1). To the relay station 3) (relay station other than 1) and 2)), set the data to access the request target (network No. 4) and request source (network No. 1).

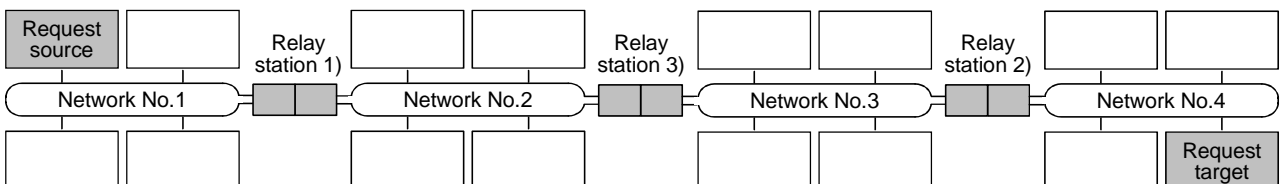

# Type SW0D5C-ACT-E ActiveX Communication Support Tool Operating Manual

MODEL	SW0D5C-ACT-E-O-E
MODEL CODE	13J981
SH(NA)-080077-A(0004)MEE	



HEAD OFFICE : MITSUBISHI DENKI BLDG MARUNOUCHI TOKYO 100-8310 TELEX : J24532 CABLE MELCO TOKYO  
NAGOYA WORKS : 1-14 , YADA-MINAMI 5 , HIGASHI-KU, NAGOYA , JAPAN

When exported from Japan, this manual does not require application to the  
Ministry of International Trade and Industry for service transaction permission.

Specifications subject to change without notice.