

MITSUBISHI

C Controller

Module

User's Manual
(Hardware)

Q06CCPU-V

Thank you for purchasing the Mitsubishi programmable controller MELSEC-Q series.

Prior to use, please read this and relevant manuals thoroughly to fully understand the product.

MELSEC-Q
Mitsubishi Programmable
Controller

MODEL	Q06CCPU-V-U-HW-J
MODEL CODE	13JY49
IB(NA)-0800401-C(0810)MEE	

● SAFETY PRECAUTIONS ●

(Always read these instructions before using this product.)

Before using this product, please read this manual and the relevant manuals introduced in this manual carefully and pay full attention to safety to handle the product correctly.

In this manual, the safety instructions are ranked as "DANGER" and "CAUTION".



DANGER

Indicates that incorrect handling may cause hazardous conditions, resulting in death or severe injury.



CAUTION

Indicates that incorrect handling may cause hazardous conditions, resulting in medium or slight personal injury or physical damage.

Note that the  CAUTION level may lead to a serious consequence according to the circumstances.

Always follow the instructions of both levels because they are important to personal safety.

Please keep this manual in a safe place for future reference and also pass this manual on to the end user.

[DESIGN PRECAUTIONS]

DANGER

- Provide a safety circuit outside the C Controller module to ensure that the entire system will operate safely even if an external power failure or C Controller module failure occurs. Failure to do so could result in accidents due to erroneous output or operation.
 - (1) For an emergency stop circuit, protection circuit and interlock circuit that is designed for incompatible actions such as forward/reverse rotation or for damage prevention such as the upper/lower limit setting in positioning, any of them must be provided outside the C Controller module.
 - (2) When the C Controller module detects the following conditions, it will disable the output (Y) from the user program and writing to buffer memory in the case of both (a) and (b) and turn off all outputs for (b). Whether to hold or clear all the outputs is set by a parameter.
 - (a) The overcurrent protector or overvoltage protector of the power supply module is activated.
 - (b) An error such as a watchdog timer error is detected by the self-diagnostic function of the C Controller module.

If an error occurs in I/O control parts and the C Controller module cannot detect the error, all the outputs may turn ON. Provide a fail-safe circuit or a preventive mechanism outside the C Controller module so that machines will operate safely in such a case. For fail-safe circuit examples, refer to Section 3.2 in this manual.
 - (3) Output could be left on or off when there is a fault in an output module relay or transistor.

So build an external monitoring circuit that will monitor any output signal that could cause serious accidents.
- If load current more than the rating or overcurrent due to a short circuit in the load has flowed in the output module for a long time, it may cause a fire and smoke. Provide an external safety device such as a fuse.
- Create the circuit so that the external power supply will turn on after the C Controller system is powered on. Turning on the external power supply first could result in accidents due to erroneous output or operation.
- For each station's operating status in the event of a each station error, refer to the corresponding each station manual.

Not doing so could result in erroneous output or operation.

[DESIGN PRECAUTIONS]

DANGER

- When controlling a running C Controller module (data modification) by connecting a personal computer to the C Controller module, create an interlock circuit on user programs so that the whole system functions safely all the time. This must be also done when performing any other controls (e.g. operating status change (status control)) or operations instructed from the computer.

In these controls, especially the one performed from an external device to a C Controller module in a remote location, some C Controller side problem may not be resolved immediately due to failure of data communications.

To prevent this, create an interlock circuit on user programs and establish corrective procedures for communication failure between the external device and the C Controller module.

- When setting up the system, do not allow any empty slot on the base unit. If any slot is left empty, be sure to use a blank cover (QG60). Otherwise, in the short circuit test or when an overcurrent or overvoltage is accidentally applied to the external I/O section, internal parts of the module may be fried.

CAUTION

- Do not install the control wires or communication cables together with the main circuit or power wires, or bring them close to each other. Keep a distance of 100 mm (3.94 inch) or more between them. Not doing so could result in malfunctions due to noise.
- When controlling a lamp, heater or solenoid valve using an output module, large current (approximately ten times greater than in normal conditions) may flow when the output is turned ON from OFF. Take preventive measures such as replacing the module with the one having sufficient rated current.

[INSTALLATION PRECAUTIONS]

CAUTION

- Use the C Controller module in an environment that meets the general specifications shown in this manual.
Using this C Controller module in an environment outside the range of the general specifications could result in an electric shock, fire, erroneous operation, and damage to or deterioration of the product.
- While pressing the installation lever located at the bottom of module, insert the module fixing tab into the fixing hole in the base unit until it stops. Then, mount the module with the fixing hole as a supporting point.
Incorrect loading of the module can cause a malfunction, failure or drop.
When using the C Controller module in the environment of frequent vibrations, tighten the module with screws.
Tighten the screws in the specified torque range.
Undertightening can cause a drop, short circuit or malfunction.
Overtightening can cause a drop, short circuit or malfunction due to damage to the screw or module.
- Connect extension cables to the connectors of the base unit and the extension module correctly.
After connection, check them for looseness.
Poor contact could cause an input or output failure.
- Be sure to set the CompactFlash™ card by pressing it into the CompactFlash™ card slot. Confirm it is completely set.
Poor contact may lead to malfunctions.
- Completely turn off the externally supplied power used in the system before mounting or removing the module.
Not doing so could result in damage to the product.
- Do not directly touch the module's conductive parts.
Doing so could cause an operation failure or give damage to the module.

[WIRING PRECAUTIONS]

DANGER

- Completely turn off the externally supplied power used in the system when wiring.
Failure to do so could result in an electric shock or damage to the product.
- Before energizing or operating the system after wiring, be sure attach the terminal cover supplied with the product. Failure to do so could result in an electric shock.

[WIRING PRECAUTIONS]

CAUTION

- Be sure to ground the FG and LG terminals to the protective ground conductor. Not doing so could result in an electric shock or erroneous operation.
- Prevent foreign matter such as dust or wiring debris from entering the module.
Failure to do so could cause fires, damage, or erroneous operation.
- When wiring, check the rated voltage and terminal layout. Connecting a power supply of a different voltage rating or incorrect wiring may result in a fire or failure.
- Connect the Ethernet and/or RS-232 cables to the corresponding connectors of the C Controller module properly.
- Tighten the terminal screws with the specified torque.
If the terminal screws are loose, it could result in short circuits, fire, or erroneous operation.
Tightening them too much may cause drop due to damages to the screws and/or the module, resulting in short circuits or malfunction.
- Be sure to place the communication and power cables into a duct or fasten them using clamps.
Failure to do so may damage the module or cables by pulling a dangling cable inadvertently or cause the module to malfunction due to poor contact.
- When disconnecting the communication and power cables from the module, do not pull a cable part by hand.
For a cable with connectors, hold the connector by hand and disconnect it from the module.
Loosen screws on the part connected to the module before disconnecting a cable. Pulling a cable that is still connected to the module may cause a malfunction or damage the module or the cable.
- Do not connect the outputs of multiple power supply modules in parallel.
Doing so can heat the power supply modules, causing fires or failures.
- Crimp, pressure weld, or solder external connectors properly with the tools specified by the maker. For crimping/pressure welding tools, refer to the user's manual for the I/O module. Incomplete connection may cause a short circuit, fire or malfunction.

[STARTUP AND MAINTENANCE PRECAUTIONS]

DANGER

- Do not touch the terminals while power is on.
Doing so may cause an electric shock.
- Correctly connect the battery.
Also, do not charge, disassemble, heat, place in fire, short circuit, or solder the battery.
Mishandling of the battery can cause overheating or cracks which could result in injury and/or fires.
- Be sure to shut off all phases of the external power supply before retightening the terminal screws and module fixing screws or cleaning.
Failure to do so may result in an electric shock.
If a terminal screw is loose, it may cause a short circuit or malfunction.
If too tight, it may cause damage to the screws and/or module, resulting in an accidental drop of the module, short circuit or malfunctions.
- When controlling a running C Controller module (data modification) by connecting a personal computer to the C Controller module, create an interlock circuit on user programs so that the whole system functions safely all the time.
This must be also done when performing any other controls (e.g. operating status change (status control)) or operations instructed from the computer.
In these controls, especially the one performed from an external device to a C Controller module in a remote location, some C Controller side problem may not be resolved immediately due to failure of data communications.
To prevent this, create an interlock circuit on user programs and establish corrective procedures for communication failure between the external device and the C Controller module.

CAUTION

- Do not disassemble or modify the modules.
Doing so could cause malfunction, erroneous operation, injury, or fire.
- Perform online operations connecting peripheral devices to the running C Controller module (especially program modification, forced output, and operation status change) after reading the manual carefully and fully ensuring the safety. Operation mistakes could cause mechanical damage or accidents.

[STARTUP AND MAINTENANCE PRECAUTIONS]

CAUTION

- Completely turn off the externally supplied power used in the system before mounting or removing the module.
Not doing so could result in module failure or malfunction.
- Do not mount/remove the module onto/from the base unit more than 50 times (IEC 61131-2 compliant), after the first use of the product.
Doing so may cause malfunction.
- Use any radio communication device such as a cellular phone or a PHS phone more than 25cm(9.85 inch) away in all directions of the C Controller module.
Not doing so can cause malfunction.
- Do not drop or give an impact to the battery installed to the module.
Doing so may damage the battery, causing the battery fluid to leak inside the battery.
If the battery is dropped or given an impact, dispose of it without using.
- Before handling the module, touch a grounded metal object to discharge the static electricity from the human body.
Not doing so can cause the module to fail or malfunction.

[DISPOSAL PRECAUTIONS]

CAUTION

- When disposing of this product, treat it as industrial waste.
When disposing of batteries, separate them from other wastes according to the local regulations.(For details of the battery directive in EU member states, refer to the C Controller Module User's Manual.)

[TRANSPORTATION PRECAUTIONS]

CAUTION

- When transporting lithium batteries, make sure to treat them based on the transport regulations.
(Refer to Chapter 7 for details of the relevant models.)

Revisions

*The manual number is noted at the lower right of the top cover.

Print Date	*Manual Number	Revision	
May, 2007	IB(NA)-0800401-A	First edition	
Sep., 2007	IB(NA)-0800401-B	<table border="1"><tr><td>Partially revised</td></tr></table> SAFETY PRECAUTIONS, Section 2.2, Section 3.1, Section 4.2.2, Section 4.3.2, Section 5.2	Partially revised
Partially revised			
Oct., 2008	IB(NA)-0800401-C	<table border="1"><tr><td>Partially revised</td></tr></table> SAFETY PRECAUTIONS, Section 3.1	Partially revised
Partially revised			

This manual confers no industrial property rights or any rights of any other kind, nor does it confer any patent licenses.
Mitsubishi Electric Corporation cannot be held responsible for any problems involving industrial property rights which may occur as a result of using the contents noted in this manual.

© 2007 MITSUBISHI ELECTRIC CORPORATION

CONTENTS

1. OVERVIEW	1
2. SPECIFICATIONS	4
2.1 General Specifications	4
2.2 Performance Specifications.....	6
3. MOUNTING AND INSTALLATION	8
3.1 Handling Precautions	8
3.2 Fail-safe Circuit	10
4. PARTS NAMES AND FUNCTIONS	19
4.1 Parts Names and Functions	19
4.2 LED indicator specifications	20
4.2.1 In normal operation mode (When the MODE LED is lit "green").....	21
4.2.2 In hardware self-diagnostic operation mode (When the MODE LED is lit "orange").....	22
4.3 Switch Operation	23
4.3.1 RUN/STOP/MODE switch operation.....	23
4.3.2 RESET/SELECT switch operation	24
5. EXTERNAL WIRING	26
5.1 10BASE-T/100BASE-TX Connection.....	26
5.2 RS-232 Connection	28
6. EXTERNAL DIMENSIONS	30
7. TRANSPORTATION PRECAUTIONS.....	31
7.1 Applicable model	31
7.2 Transportation guidelines	31

About Manuals

The following manuals are also related to this product.
If necessary, please place an order referring to the table below.

Related Manuals

Manual name	Manual Number (Model code)
C Controller Module User's Manual This manual explains the features, specifications, functions and troubleshooting of the C Controller module. (Sold separately)	SH-080720ENG (13JZ05)
QCPU (Q mode) CPU Module User's Manual (Hardware) This manual provides the specifications and other information of power supply modules, base units and I/O modules. (Sold separately)	IB-0800061 (13JL96)
QCPU User's Manual (Hardware Design, Maintenance and Inspection) This manual provides the specifications of the CPU modules, power supply modules, base units, extension cables, memory cards and others. (Sold separately)	SH-080483ENG (13JR73)

1. OVERVIEW

(1) About this manual

The C Controller module installation and wiring to other devices are described in this manual.

This manual explains the C Controller module.

Refer to the QCPU (Q mode) CPU Module User's Manual (Hardware) for the details of the C Controller system listed below. When referring to the manual, read the "CPU module" as the "C Controller module", and the "Programmable controller" as the "C Controller system".

Item	Reference to related manual
Checking power supply module specifications	Section 2.3
Checking base unit specifications	Section 2.4
Conforming the C Controller system to the EMC and Low Voltage Directives	Chapter 3*1
Mounting the module	Section 4.1
Wiring the power supply module	Section 4.3
Checking part names of power supply module	Section 4.7
Checking I/O module specifications and connection methods	Chapter 5

*1 To conform the C Controller module to the EMC Directive, it must satisfy the criteria for the noise immunity standards of the Ethernet and RS-232 cables.

(a) Ethernet cable

Use shielded twisted pair cables as the twisted pair cables connected to the 10BASE-T/100BASE-TX interface connectors for the C Controller module. For the shielded twisted pair cables, strip part of the outer cover and earth the exposed shield section to the ground on the widest contact surface as shown in the following.

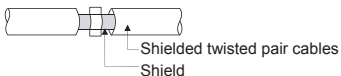

(b) RS-232 cable

For the RS-232 cable to be pulled out of the control panel, always earth the shield section of the shielded cable as shown below.

- 1) Earth the shield of the shielded cable as near the C Controller module as possible taking care so that the earthed cables are not induced electromagnetically by the cable to be earthed.
- 2) Take appropriate measures so that the shield section of the shielded cable from which the outer cover was partly removed for exposure is earthed to the control panel on an increased contact surface.

A clamp may also be used as shown in the following.

In this case, however, apply a cover to the inner surface of the control panel which comes in contact with the clamp when painting.

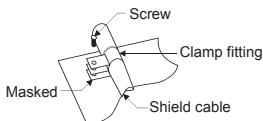
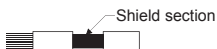

Recommended clamp fitting: Mitsubishi AD75CK

- Note) The method of earthing by soldering a wire onto the shield section of the shielded cable as shown below is not recommended. The high frequency impedance will increase and the shield will be ineffective.

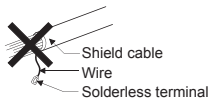

(2) Included parts

The following tables list the parts included with the C Controller module.

Product Name	Type	Quantity
C Controller Module	Q06CCPU-V	1
Battery	Q6BAT	1
This Manual	-	1

(3) Generic terms and abbreviations used in this manual

Unless otherwise specified, this manual uses the following generic terms and abbreviations to explain the Q06CCPU-V C Controller module.

Generic term/abbreviation	Description
C Controller module	Abbreviation for the Q06CCPU-V C Controller module
C Controller system	Generic term for systems where the C Controller module is mounted

2. SPECIFICATIONS

2.1 General Specifications

The following indicates the general specifications of the C Controller module.

Item	Specifications*6					
Operating ambient temperature	0 to 55°C					
Storage ambient temperature	-25 to 75°C *3					
Operating ambient humidity	5 to 95%RH*4, non-condensing					
Storage ambient humidity	5 to 95%RH*4, non-condensing					
Vibration resistance	Conforming to JIS B 3502, IEC 61131-2	Under intermittent vibration	Frequency	Acceleration	Amplitude	Sweep count 10 times each in X, Y, Z directions (for 80 min.)
			10 to 57Hz	-	0.075mm (0.003 inch)	
		Under continuous vibration	57 to 150Hz	9.8m/s ²	-	
			10 to 57Hz	-	0.035mm (0.001 inch)	
			57 to 150Hz	4.9m/s ²	-	
Shock resistance	Conforming to JIS B 3502, IEC 61131-2 (147 m/s ² , 3 times in each of 3 directions X, Y, Z)					
Operating ambience	No corrosive gases					
Operating altitude*5	2000m (6562ft.) max.					
Installation location	Inside control panel					
Overvoltage category*1	II max.					
Pollution level *2	2 max.					

- *1 This indicates the section of the power supply to which the equipment is assumed to be connected between the public electrical power distribution network and the machinery within premises.
Category II applies to equipment for which electrical power is supplied from fixed facilities.
The surge voltage withstand level for up to the rated voltage of 300 V is 2500 V.
- *2 This index indicates the degree to which conductive material is generated in terms of the environment in which the equipment is used.
Pollution level 2 is rated when only non-conductive pollution occurs.
A temporary conductivity caused by condensing can be expected occasionally.
- *3 The storage ambient temperature is -20 to 75°C if the system includes the AnS series modules.
- *4 The operating ambient humidity and storage ambient humidity are 10 to 90%RH if the system includes the AnS series modules.
- *5 Do not use or store the C Controller module under pressure higher than the atmospheric pressure of altitude 0m.
Doing so can cause a malfunction.
For use in a pressurized environment, please contact your sales representative.
- *6 When installing a commercially available CompactFlash card into the C Controller module, please follow the lower specifications of either the C Controller module or CompactFlash card.

2.2 Performance Specifications

This section explains the performance specifications of the C Controller module.

Item	Specifications	
Hardware specifications	-	
Endian format (Memory format)	Little endian	
User file capacity (For user file storage)	Standard ROM CompactFlash card	
	6M bytes Depends on the CompactFlash card used (max. 1G bytes)	
Work RAM (for OS, driver, user program execution)	64M bytes	
Battery-backed-up RAM	128k bytes	
Number of writes to standard ROM	Max. 100,000 times to the same area	
10BASE-T/100BASE-TX	-	
Interface*1	10BASE-T 100BASE-TX	
Communication method	Full-duplex/half-duplex communication mode	
Data transmission speed	10Mbps 100Mbps	
Transmission method	Base band	
Number of cascaded stages	Max. 4 stages Max. 2 stages	
Maximum segment length*2	100m	
Connector applicable to external wiring	RJ45	
Supported function	Auto negotiation function (automatically recognizes 10BASE-T/100BASE-TX)	
RS-232	-	
Interface	Compliance with RS-232 (D-sub 9 pin)	
Communication method	Full-duplex/half-duplex communication method	
Synchronization method	Start-stop synchronization method	
Transmission speed	9600, 14400, 19200, 28800, 38400, 57600, 115200bps	
Transmission distance	Max. 15m	
Data format	Start bit	1
	Data bit	7/8
	Parity bit	1/None
	Stop bit	1/2
Parity check	Parity check performed/not performed	
Sum check code	Sum check performed/not performed	
Transmission control	Flow control (RS/CS control) performed/not performed	
Recommended cable	7/0.127 □ P HRV-SV outside diameter: 8.5mm or longer (Oki Electric Cable Company, Limited Specify the number of pairs in □.)	
Connector applicable to external wiring	9 pin D-sub (Male) fixing type	

Item	Specifications
CompactFlash card	-
Supply power voltage	3.3V \pm 5%
Supply power capacity	Max. 150mA
Card size ^{*3}	TYPE I card
Number of loadable cards	1
Number of I/O points (number of points accessible to actual I/O modules)	4096 points (X/Y0 to FFF)
Clock function	Year, month, day, hour, minute, second, day of week (automatic leap year detection) Clock accuracy: Daily error -10.89 to +8.64 seconds (0 to 55°C) ^{*4} Daily error -4.32 to +5.25 seconds (25°C) ^{*4}
Permissible momentary stop time	Depends on the power supply module
5V DC internal current consumption	0.71A
External dimensions	98(H) \times 27.4(W) \times 89.3(D)[mm]
Weight	0.17kg

*1 The C Controller module differentiates 10BASE-T and 100BASE-TX according to the target device.

*2 Distance between the hub and node.

*3 A TYPE II card is not available.
I/O cards, such as a modem card, are not available.

*4 Error of -0.5 to +0.5 seconds may further be produced at power-on.

3. MOUNTING AND INSTALLATION

3.1 Handling Precautions

This section explains the handling precautions for the C Controller module.

CAUTION

- Use the C Controller module in an environment that meets the general specifications shown in this manual.
Using this C Controller module in an environment outside the range of the general specifications could result in an electric shock, fire, erroneous operation, and damage to or deterioration of the product.
- While pressing the installation lever located at the bottom of module, insert the module fixing tab into the fixing hole in the base unit until it stops. Then, mount the module with the fixing hole as a supporting point. Incorrect loading of the module can cause a malfunction, failure or drop. When using the C Controller module in the environment of frequent vibrations, tighten the module with screws. Tighten the screws in the specified torque range. Undertightening can cause a drop, short circuit or malfunction. Overtightening can cause a drop, short circuit or malfunction due to damage to the screw or module.
- Connect extension cables to the connectors of the base unit and the extension module correctly.
After connection, check them for looseness.
Poor contact could cause an input or output failure.
- Be sure to set the CompactFlash™ card by pressing it into the CompactFlash™ card slot.
Confirm it is completely set.
Poor contact may lead to malfunctions.
- Completely turn off the externally supplied power used in the system before mounting or removing the module.
Not doing so could result in damage to the product.
- Do not directly touch the module's conductive parts.
Doing so could cause an operation failure or give damage to the module.

- (1) The casing of the C Controller module is made of resin. Do not drop it or not apply strong shock to it.
- (2) Do not remove the printed boards of the module from the casing. Doing so may cause a failure.
- (3) Tighten the module fixing screws and the RS-232 cable connector mounting screw within the following range.

Screw location	Tightening torque range	Remarks
Module fixing screw (normally not required)(M3 screw) ^{*1}	0.36to0.48N•m	-
RS-232 cable connector mounting screw (M2.6 screw)	0.20 to 0.39N•m	Depth of screw hole:L=3.2mm or less

*1 The module can be easily secured to a base unit by the hook on the module top. However, it is recommended to fix it with the module mounting screws in a place of high vibration and/or shock.

- (4) When installing a dummy CompactFlash card to the C Controller module, use the dummy CompactFlash card installed when shipping.

Do not use the dummy CompactFlash card that has no "A" printed, as shown in the figure below, to the products whose serial No. (first four digits) is "1008" or later. Failure to do so may disable to remove the dummy CompactFlash card, resulting in damage to the CompactFlash card slot.

A dummy CompactFlash card with "A" printed, as shown in the figure below, is installed to the products whose serial number (first four digits) is "1008" or later when shipping.

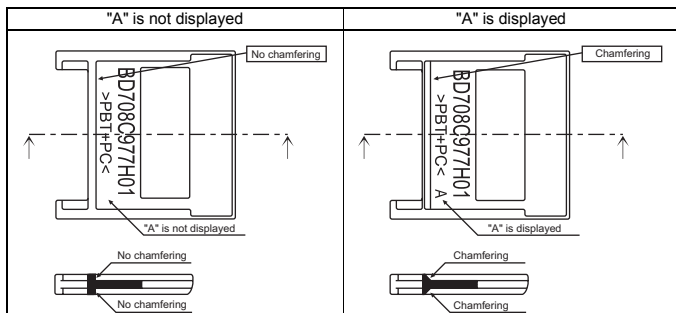

3.2 Fail-safe Circuit

DANGER

- Provide a safety circuit outside the C Controller module to ensure that the entire system will operate safely even if an external power failure or C Controller module failure occurs.
Failure to do so could result in accidents due to erroneous output or operation.
 - (1) For an emergency stop circuit, protection circuit and interlock circuit that is designed for incompatible actions such as forward/reverse rotation or for damage prevention such as the upper/lower limit setting in positioning, any of them must be provided outside the C Controller module.
 - (2) When the C Controller module detects the following conditions, it will disable the output (Y) from the user program and writing to buffer memory in the case of both (a) and (b) and turn off all outputs for (b). Whether to hold or clear all the outputs is set by a parameter.
 - (a) The overcurrent protector or overvoltage protector of the power supply module is activated.
 - (b) An error such as a watchdog timer error is detected by the self-diagnostic function of the C Controller module.

If an error occurs in I/O control parts and the C Controller module cannot detect the error, all the outputs may turn ON.
Provide a fail-safe circuit or a preventive mechanism outside the C Controller module so that machines will operate safely in such a case.
 - (3) Output could be left on or off when there is a fault in an output module relay or transistor.
So build an external monitoring circuit that will monitor any output signal that could cause serious accidents.

DANGER

- If load current more than the rating or overcurrent due to a short circuit in the load has flowed in the output module for a long time, it may cause a fire and smoke. Provide an external safety device such as a fuse.
- Create the circuit so that the external power supply will turn on after the C Controller system is powered on. Turning on the external power supply first could result in accidents due to erroneous output or operation.
- For each station's operating status in the event of a each station error, refer to the corresponding each station manual. Not doing so could result in erroneous output or operation.
- When controlling a running C Controller module (data modification) by connecting a personal computer to the C Controller module, create an interlock circuit on user programs so that the whole system functions safely all the time. This must be also done when performing any other controls (e.g. operating status change (status control)) or operations instructed from the computer. In these controls, especially the one performed from an external device to a C Controller module in a remote location, some C Controller side problem may not be resolved immediately due to failure of data communications. To prevent this, create an interlock circuit on user programs and establish corrective procedures for communication failure between the external device and the C Controller module.

CAUTION

- Do not install the control wires or communication cables together with the main circuit or power wires, or bring them close to each other. Keep a distance of 100 mm (3.94 inch) or more between them. Not doing so could result in malfunctions due to noise.
- When controlling a lamp, heater or solenoid valve using an output module, large current (approximately ten times greater than in normal conditions) may flow when the output is turned ON from OFF. Take preventive measures such as replacing the module with the one having sufficient rated current.

When the C Controller system is powered ON-OFF, the control output may not be supplied normally for a little while because of the delay time and rise time difference between the C Controller system power supply and the external power supply for the control target (especially in DC). In the case of a DC output module, for example, when power is applied to the external power supply first and then the C Controller system power supply, the DC output module may temporarily generate false output at power-on of the C Controller system.

Therefore, it is necessary to configure a circuit in which power is applied to the C Controller system first.

Also, erroneous operations may be performed when the external power supply or C Controller module is faulty.

To prevent the erroneous operations from resulting in entire system failure, and from a viewpoint of fail-safe system operation, configure circuits outside the C Controller module for the areas that will lead to mechanical damage and/or accidents due to erroneous operations (emergency stop circuit, protective circuit, interlock circuit, etc.)

A system design circuit example based on the above viewpoint is shown on the next page.

- *1 Perform programming to execute the following operation at start-up of the C Controller module.
- 1) Turning ON Ym when battery voltage drop is detected.
Create a program so that Ym is turned ON by the QBF_Y_Out_BitEx function when the "Builtin battery error status" of the QBF_ReadStatusEx function turns to 1 (battery error occurrence).
 - 2) Turning ON Yn at start of the user program.
Create a program so that Yn is turned ON to release interlocks at start of the C Controller module user program.
- *2 Perform programming to execute the following operation at start-up of the C Controller module.
- 1) Turning ON Ym when battery voltage drop is detected.
Create a program so that Ym is turned ON by the QBF_Y_Out_BitEx function when the "Builtin battery error status" of the QBF_ReadStatusEx function turns to 1 (battery error occurrence).
 - 2) Turning ON Yn at start of the user program.
Create a program so that Yn is turned ON to release interlocks at start of the C Controller module user program.
 - 3) Starting system processing after XM turns ON and the DC input signals is established (after the DC input signal establishment time elapses).
Create a program so that the system processing is executed when the DC input signal establishment time elapses after XM has turned ON (this can be confirmed by the QBF_X_In_BitEx function).
(The DC input signal establishment time is a time from when RA2 turns ON until the DC input signal is established 100%. Set the time to 0.5 s.)
However, when a voltage relay is used as RA2, it is not necessary to set the DC input signal establishment time in the user program.

(2) System design circuit example (when using $\overline{\text{ERR}}$ contact of power supply module)

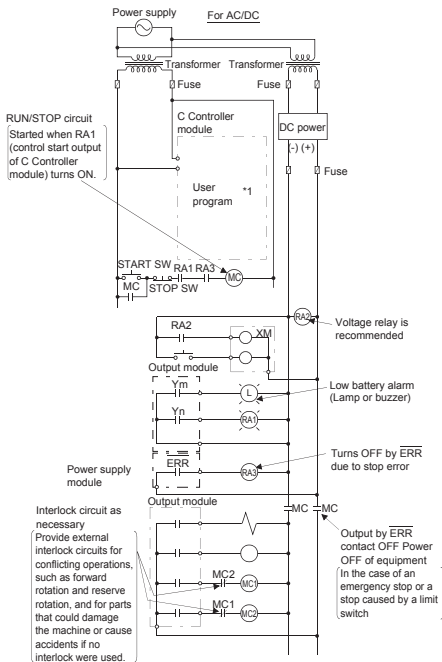

The power-ON procedure is as follows:

For AC/DC

- 1) Turn ON the power.
- 2) Set the C Controller module to "RUN".
- 3) When the DC power is established, RA2 goes ON.
- 4) RA2's ON turns XM ON, and processing starts in the user program *1 when the DC input signal is established 100%.
- 5) Turn ON the start switch.
- 6) When the magnetic contact (MC) comes ON, the output equipment is driven by the user program.

*1 Perform programming to execute the following operation at start of the C Controller module.

- 1) Turning ON Ym when battery voltage drop is detected.
Create a program so that Ym is turned ON by the QBF_Y_Out_BitEx function when the "Builtin battery error status" of the QBF_ReadStatusEx function turns to 1 (battery error occurrence).
- 2) Turning ON Yn at start of the user program.
Create a program so that Yn is turned ON to release interlocks at start of the C Controller module user program.
- 3) Starting system processing after XM turns ON and the DC input signals is established (after the DC input signal establishment time elapses).
Create a program so that the system processing is executed when the DC input signal establishment time elapses after XM has turned ON (this can be confirmed by the QBF_X_In_BitEx function).
(The DC input signal establishment time is a time from when RA2 turns ON until the DC input signal is established 100%. Set the time to 0.5 s.)
However, when a voltage relay is used as RA2, it is not necessary to set the DC input signal establishment time in the user program.

- (3) Fail-safe measures against C Controller system failure
 Failure of the C Controller module is generally detected by the self-diagnostic function. However, if an I/O control part is faulty, the failure may not be detected by the C Controller module. In such a case, all the I/O may turn ON or OFF depending on the failure, and normal operation and safety of the control target may not be ensured.
- Though Mitsubishi products are manufactured under strict quality control, the C Controller system may fail for unspecific reasons. To prevent mechanical damage and/or accidents in that case, please configure a fail-safe circuit outside the C Controller module. The following shows a system example and a fail-safe circuit example.

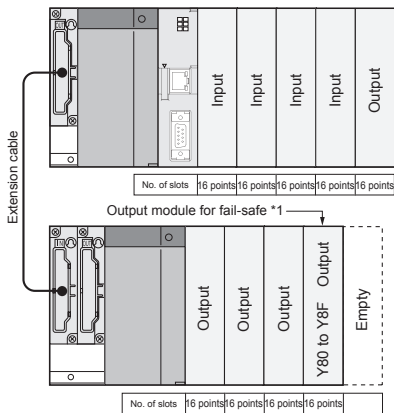

- *1 The output module for fail-safe should be loaded in the last slot of the system. (Y80 to Y8F in the above system.)

<Fail-safe circuit example>

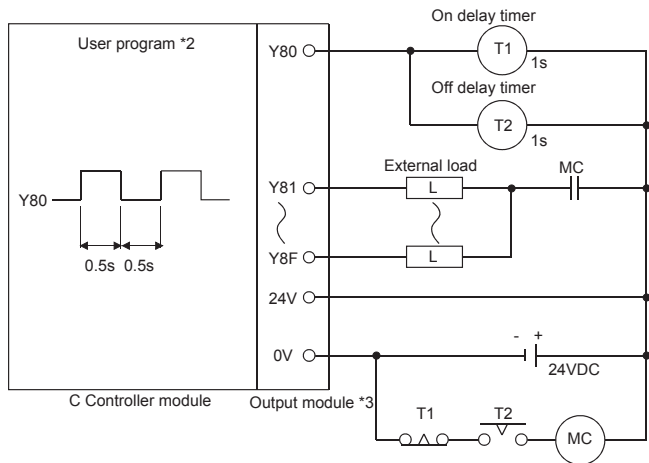

- *2 Create a program so that Y80 alternates between ON and OFF at intervals of 0.5 s. (Use the QBF_Y_Out_BitEx function to turn Y80 ON/OFF.)
- *3 Y80 repeats turning ON and then OFF at 0.5s intervals. Use a no-contact output module (transistor in the example shown above).

4. PARTS NAMES AND FUNCTIONS

4.1 Parts Names and Functions

The part names of the C Controller module are shown below.

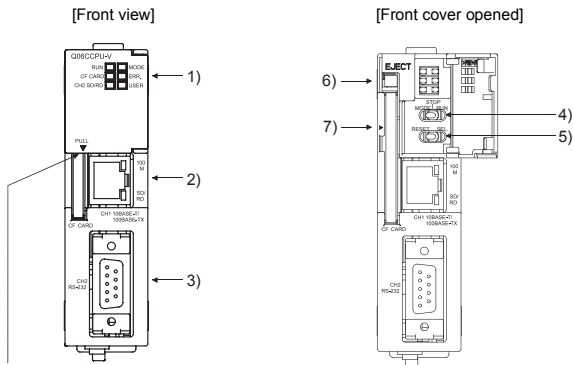

Put your finger here to open the front cover.

[Side view]

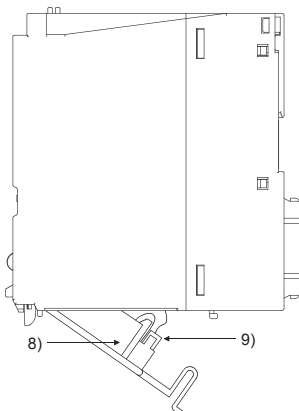

No.	Name	Description
1)	Indicator LEDs	Refer to Section 4.2 for the indicator LEDs.
2)	10BASE-T/100BASE-TX interface connector (RJ45)	Connector used to connect the C Controller module to 10BASE-T/100BASE-TX. (The C Controller module determines 10BASE-T or 100BASE-TX depending on the target device.)
3)	RS-232 interface connector	Connector used to connect the C Controller module to RS-232.
4)	RUN/STOP/MODE switch ^{*2}	Refer to Section 4.3.1 for the RUN/STOP/MODE switch.
5)	RESET/SELECT switch ^{*2}	Refer to Section 4.3.2 for the RESET/SELECT switch.
6)	EJECT button	Used to remove the CompactFlash card from the C Controller module.
7)	CompactFlash card installation slot	Slot used for installing the CompactFlash card into the C Controller module. (A dummy CompactFlash card is factory-installed. ^{*1})
8)	Battery	Used for protecting the standard ROM files, and backing up the battery-backed-up RAM data and the clock data.
9)	Battery connector pin	For connection of the battery lead wire. (The lead wire is shipped disconnected from the connector to prevent battery consumption.)

- *1 Keep the dummy CompactFlash card in a safe place after replacing it with an actual CompactFlash card so that it can be used again in the future when the CompactFlash card is removed.
- *2 Operate the RUN/STOP/MODE switch and RESET/SELECT switch by hand. Using a screwdriver or any other tool can cause a failure.

4.2 LED indicator specifications

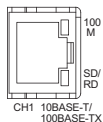
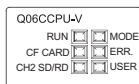

4.2.1 In normal operation mode (When the MODE LED is lit "green")

Change the operation mode by the switch.(Refer to Section 4.3)

LED indicator*1	LED status	Description
RUN	On	The C Controller module is in the RUN status. (Output (Y) from user program and writing to buffer memory are enabled)
	Off	The C Controller module is in the STOP/PAUSE status. (Output (Y) from user program and writing to buffer memory are disabled)
	Flashing	The script file "STARTUP.CMD" is in execution.
MODE	On	Normal operation mode (VxWorks running)
	Off	Hardware fault occurred or during reset
	Flashing	Shutdown completed (Refer to the C Controller Module User's Manual.)
ERR.	On	Continue error occurred
	Off	Normal
	Flashing	Stop error occurred*2
USER	On	Can be controlled by the user program QBF_ControlLED function*3
	Off	
	Flashing	
CF CARD	On	CompactFlash card mounted (Refer to the C Controller Module User's Manual.)
	Off	CompactFlash card not mounted or unmounted (Refer to the C Controller Module User's Manual.)
	Flashing	CompactFlash card being unmounted by the RESET/SELECT switch (Refer to the C Controller Module User's Manual.)
CH2 SD/RD	On	CH2 side (RS-232 interface) sending or receiving data
	Off	Data not transmitted
100M	On	Being connected at 100Mbps
	Off	Being connected at 10Mbps
SD/RD	On/ Flashing	CH1 side (10BASE-T/100BASE-TX interface) sending or receiving data
	Off	Data not transmitted

*1 All LEDs turn off while the module is reset.

*2 When a system watchdog timer error has occurred, the RUN LED and MODE LED turn off and the ERR. LED flashes.

*3 For details of the bus interface function, refer to the C Controller Module User's Manual.

4.2.2 In hardware self-diagnostic operation mode (When the MODE LED is lit "orange")

For the hardware self-diagnostic function, refer to the C Controller Module User's Manual.

Change the operation mode by the switch. (Refer to Section 4.3)

LED indicator	Name	LED status	Description
MODE	MODE	On	Hardware self-diagnostic mode
		Off	Hardware fault occurred or the module is being reset
ERR.	Hardware self-diagnostic error	Off	When all LEDs but the MODE LED turn off, it indicates that the self-diagnostic test has not been executed yet or is normally completed.
		Flashing	An error has occurred when the mode (Mode 1, Mode 2, Mode 3, Default setting mode) selected by SELECT operation was executed. The error location can be confirmed by the ON/OFF status of the following LEDs. "RUN" "CF CARD" "CH2 SD/RD" "USER"
RUN	Mode 1/Error location indication	On	ERR. LED off : Mode 1 selected
		Flashing	ERR. LED flashing : Indicates the location of the error that occurred by execution of Mode 1 to 3. Mode 1 in execution
CF CARD	Mode 2/Error location indication* ¹	On	ERR. LED off : Mode 2 selected
		Flashing	ERR. LED flashing : Indicates the location of the error that occurred by execution of Mode 1 to 3. Mode 2 in execution
CH2 SD/RD	Mode 3/Error location indication	On	ERR. LED off : Mode 3 selected
		Flashing	ERR. LED flashing : Indicates the location of the error that occurred by execution of Mode 1 to 3. Mode 3 in execution
USER	Default setting mode/Error location indication* ¹	On	ERR. LED off : Default setting mode selected
		Flashing	ERR. LED flashing : Error occurred during execution of Default setting mode Default setting mode in execution

*1 When CF CARD LED and USER LED are turned ON simultaneously, Standard ROM format setting is shown.

For Standard ROM format setting, refer to the C Controller Module User's Manual.

4.3 Switch Operation

4.3.1 RUN/STOP/MODE switch operation



Position	Operation	
RUN	In normal operation mode	The C Controller module is operating. (Output (Y) from user program and writing to buffer memory are enabled)
	In hardware self-diagnostic operation mode	For the hardware self-diagnostic function, refer to the C Controller Module User's Manual.
STOP	Operation of the C Controller module is stopped.*1 Switching RUN to STOP turns off all outputs (Y). (Output (Y) from user program and writing to buffer memory are disabled)	
MODE	Used by the hardware self-diagnostics function. For the hardware self-diagnostic function, refer to the C Controller Module User's Manual.	

*1 Output (Y) and writing to buffer memory, etc. from the <<Module monitoring>> tab of the C Controller setting utility are executable.

4.3.2 RESET/SELECT switch operation



Position	Operation	
RESET	When holding RESET position	All LEDs turn off and the hardware is reset. *1*2
	When returning RESET position to the neutral position	Reset is canceled. The module starts up in either of the following operation modes depending on the RUN/STOP/MODE switch position. <ol style="list-style-type: none"> 1) In the case of the RUN/STOP position, the module restarts from the OS and system software, and starts up in the normal operation mode. (The MODE LED is turned ON in "green".) 2) In the case of the MODE position, the module starts up in the hardware self-diagnostic operation mode. (The MODE LED is lit turned ON in "orange".)
SEL.	In normal operation modes	When the switch is held in the SELECT position , the CompactFlash card is unmounted. *3*4 <ol style="list-style-type: none"> 1) Hold the RESET/SELECT switch in the SELECT position. When unmounting is started with the switch held in the SELECT position, the CF CARD LED of the C Controller module flashes. At this time, keep holding the SELECT position. 2) When the unmounting is completed, the CF CARD LED stops flashing and turns off. After the CF CARD LED is turned off, return the switch to the neutral position. Unmounting is not complete if the RESET/ SELECT switch is returned to the neutral from position before the CF CARD LED turns off.
	In hardware self-diagnostic operation mode	Used by the hardware self-diagnostics function. For the hardware self-diagnostic function, refer to the C Controller Module User's Manual.

- *1 In a multiple CPU system configuration, reset CPU No.1.
- *2 Before resetting, close all running user programs in the C Controller module. Resetting the module while running any user programs may corrupt the user programs and data files.
For details, refer to the C Controller Module User's Manual.
- *3 Perform this operation only when a file is not being written to the CompactFlash card. Unmounting the CompactFlash card with the RESET/ SELECT switch during file writing to the CompactFlash card may corrupt the data on the CompactFlash card or cause a file system error. When removing the CompactFlash card during file writing, perform the stop processing of access to the CompactFlash card.
For the access stop processing, refer to the C Controller Module User's Manual.
- *4 When the SELECT position is held in either of the following states, unmounting is not executed. (The CF CARD LED does not flash.)
- When no CompactFlash card has been installed.
 - When the CompactFlash card has already been unmounted.

5. EXTERNAL WIRING

5.1 10BASE-T/100BASE-TX Connection

Sufficient safety precautions must be taken when installing the 100BASE-TX and 10BASE-T networks.

Consult a specialist when connecting cable terminals or installing trunk line cables, etc.

(1) Twisted pair cable

Twisted pair cables are used for connection to 10BASE-T/100BASE-TX interfaces.

Use the twisted pair cable that meets IEEE802.3 10BASE-T/100BASE-TX standards.

(a) For 100Mbps

Either of the following 1) and 2) can be used.

- 1) Unshielded twisted pair cable (UTP cable), Category 5
- 2) Shielded twisted pair cable (STP cable), Category 5

(b) For 10Mbps

Either of the following 1) and 2) can be used.

- 1) Unshielded twisted pair cable (UTP cable), Category 3 (4, 5)
- 2) Shielded twisted pair cable (STP cable), Category 3 (4, 5)

POINT

During the high speed communication (100Mbps) via 100BASE-TX connection, a communication error may occur due to high frequency noise generated from the device other than C Controller module, depending on the installation environment.

When configuring the network system, take the following measures on the C Controller module side to eliminate the effect of high frequency noise.

(1) Wiring

- Keep the twisted pair cables away from the main circuit or power cables.
- Make sure to place the twisted pair cables in a duct.

(2) Cable

- In the environment where the cable is susceptible to noise, use the shielded twisted pair cable (STP cable).

(3) Retry processing

- In the environment where cables are susceptible to noise, include the retry processing in the user program.

(4) 10Mbps communication

- Connect the 10Mbps-compatible device to C Controller module, and then transmit data at transmission speed of 10Mbps.

(2) Hub

The C Controller module discriminates between 10BASE-T and 100BASE-TX and between full-duplex and half-duplex communication modes according to the hub.

When connecting to the hub that does not have the auto negotiation function, set the hub to operate in the half-duplex communication mode.

5.2 RS-232 Connection

RS-232 cables are used for connection to RS-232 interfaces.

(1) RS-232 connector specifications

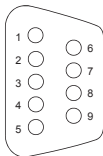

Pin No.	Signal abbreviation	Signal name	Signal direction C Controller module ↔ Modem
1	CD(DCD)	Data Carrier Detect	←
2	RD(RXD)	Received Data	←
3	SD(TXD)	Transmitted Data	→
4	ER(DTR)	Data Terminal Ready	→
5	SG(GND)	Signal Ground	←
6	DR(DSR)	Data Set Ready	←
7	RS(RTS)	Request To Send	→
8	CS(CTS)	Clear To Send	←
9	CI(RI)	Ring Indicator	←

(2) RS-232 interface connector

The C Controller module uses the following RS-232 interface connector.

- DDK Ltd.
9-pin D-sub (female) screw type
17L-10090-27 (D9AC) (-FA)

Use the following as the connector shell of the connector cable of the C Controller module side.

- DDK Ltd.
Plug, shell: 17JE-23090-02 (D8A) (-CG)
- Connector fitting screw (M2.6)

(3) RS-232 cable

Use the RS-232-compliant cable which length is 15m or less.

[Recommended cable]

7/0.127 □P HRV-SV... Specify the number of pairs in □.

(For 13 pairs, specify 7/0.127 13P HRV-SV.)

(Oki Electric Cable Company, Limited)

(4) Precautions for wiring RS-232 cables

Precautions for wiring RS-232 cables are shown below.

- (a) Ground the RS-232 Cable shield to a single point.
- (b) Use any of the connector shells indicated in (2) on the C Controller module side of the RS-232 cable.
- (c) Connect the external device according to its specifications.
- (d) For the bending radius of the connection cable, refer to Chapter 6.
- (e) Do not short the FG signal and SG signal lines of the RS-232 connection cable.
When the FG signal and SG signal lines are connected inside the external device, do not connect the FG signal line to the C Controller module.

POINT

<p>In RS-232 connection, a communication error may occur due to noise generated from the devices other than the C Controller system, depending on the installation environment.</p>

<p>In the environment where cables are susceptible to noise, include the retry processing in the user program.</p>
--

7. TRANSPORTATION PRECAUTIONS

When transporting lithium batteries, be sure to treat them based on the transportation regulations.

7.1 Applicable model

The lithium battery used for the C Controller module is classified as shown in the table below.

Product name	Model name	Description	Handled as
Battery for Q series	Q6BAT	Lithium battery	Non-dangerousgoods

7.2 Transportation guidelines

Products are packed properly in compliance with the transportation regulations prior to shipment. When repacking any of the unpacked products to transport it to another location, be sure to observe the IATA Dangerous Goods Regulations, IMDG Code and other local transportation regulations.

For details, please consult your transportation company.

Ethernet is a trademark of Xerox Corporation.

CompactFlash is a trademark of SanDisk Corporation.

Other company names and product names used in this document are trademarks or registered trademarks of respective owners.

Warranty

Mitsubishi will not be held liable for damage caused by factors found not to be the cause of Mitsubishi; machine damage or lost profits caused by faults in the Mitsubishi products; damage, secondary damage, accident compensation caused by special factors unpredictable by Mitsubishi; damages to products other than Mitsubishi products; and to other duties.

For safe use

- This product has been manufactured as a general-purpose part for general industries, and has not been designed or manufactured to be incorporated in a device or system used in purposes related to human life.
- Before using the product for special purposes such as nuclear power, electric power, aerospace, medicine or passenger movement vehicles, consult with Mitsubishi.
- This product has been manufactured under strict quality control. However, when installing the product where major accidents or losses could occur if the product fails, install appropriate backup or failsafe functions in the system.

Country/Region	Sales office/Tel	Country/Region	Sales office/Tel
U.S.A	Mitsubishi Electric Automation Inc. 500 Corporate Woods Parkway Vernon Hills, IL 60061, U.S.A. Tel : +1-847-478-2100	Hong Kong	Mitsubishi Electric Automation (Hong Kong) Ltd. 10th Floor, Manulife Tower, 169 Electric Road, North Point, Hong Kong Tel : +852-2887-8870
Brazil	MELCO-TEC Rep. Com.e Assessoria Tecnica Ltda. Rua Correia Dias, 184, Edificio Paraiso Trade Center-8 andar Paraiso, Sao Paulo, SP Brazil Tel : +55-11-5908-8331	China	Mitsubishi Electric Automation (Shanghai) Ltd. 4/F Zhi Fu Plaza, No.80 Xin Chang Road, Shanghai 200003, China Tel : +86-21-6120-0808
Germany	Mitsubishi Electric Europe B.V. German Branch Gothaer Strasse 8 D-40880 Ratingen, GERMANY Tel : +49-2102-486-0	Taiwan	Setsuyo Enterprise Co., Ltd. 6F No.105 Wu-Kung 3rd.Rd, Wu-Ku Hsiang, Taipei Hsine, Taiwan Tel : +886-2-2299-2499
U.K	Mitsubishi Electric Europe B.V. UK Branch Travellers Lane, Hatfield, Hertfordshire., AL10 8XB, U.K. Tel : +44-1707-276100	Korea	Mitsubishi Electric Automation Korea Co., Ltd. 1480-6, Gayang-dong, Gangseo-ku Seoul 157-200, Korea Tel : +82-2-3660-9552
Italy	Mitsubishi Electric Europe B.V. Italian Branch Centro Dir. Colleoni, Pal. Perseo-Ingr.2 Via Paracelso 12, I-20041 Agrate Brianza., Milano, Italy Tel : +39-039-60531	Singapore	Mitsubishi Electric Asia Pte, Ltd. 307 Alexandra Road #05-01/02, Mitsubishi Electric Building, Singapore 159943 Tel : +65-6470-2460
Spain	Mitsubishi Electric Europe B.V. Spanish Branch Carretera de Rubi 76-80, E-08190 Sant Cugat del Valles, Barcelona, Spain Tel : +34-93-565-3131	Thailand	Mitsubishi Electric Automation (Thailand) Co., Ltd. Bang-Chan Industrial Estate No.111 Moo 4, Serithai Rd, T.Kannayao, A.Kannayao, Bangkok 10230 Thailand Tel : +66-2-517-1326
France	Mitsubishi Electric Europe B.V. French Branch 25, Boulevard des Bouvets, F-92741 Nanterre Cedex, France TEL: +33-1-5568-5568	Indonesia	P.T. Autoteknindo Sumber Makmur Muara Karang Selatan, Block A/Utara No.1 Kav. No.11 Kawasan Industri Pergudangan Jakarta - Utara 14440, P.O.Box 5045 Jakarta, 11050 Indonesia Tel : +62-21-6630833
South Africa	Circuit Breaker Industries Ltd. Private Bag 2016, ZA-1600 Isando, South Africa Tel : +27-11-928-2000	India	Messung Systems Pvt, Ltd. Electronic Sadan NO:III Unit No15, M.I.D.C Bhosani, Pune-411026, India Tel : +91-20-2712-3130
		Australia	Mitsubishi Electric Australia Pty. Ltd. 348 Victoria Road, Rydalmere, N.S.W 2116, Australia Tel : +61-2-9684-7777

MITSUBISHI ELECTRIC CORPORATION

HEAD OFFICE: TOKYO BUILDING, 2-7-3 MARUNOUCHI, CHIYODA-KU, TOKYO 100-8310, JAPAN
NAGOYA WORKS: 1-14, YADA-MINAMI 5-CHOME, HIGASHI-KU, NAGOYA, JAPAN

When exported from Japan, this manual does not require application to the Ministry of Economy, Trade and Industry for service transaction permission.

Specifications subject to change without notice.
Printed in Japan on recycled paper.