

mitsubishi

Intelligent Communication Module

User's Manual
(Hardware)

A1SD51S

Thank you for buying the Mitsubishi general-purpose programmable logic controller MELSEC-A Series

Prior to use, please read both this manual and detailed manual thoroughly and familiarize yourself with the product.



MODEL	A1SD51S-U-HW
MODEL CODE	13JP69
IB(NA)-0800311-A(0509)MEE	

● SAFETY PRECAUTIONS ●

(Always read these instructions before using this equipment.)

Before using this product, please read this manual and the relevant manuals introduced in this manual carefully and pay full attention to safety to handle the product correctly.

These precautions apply only to this product. For the PLC system safety precautions, refer to the user's manual of your CPU module.

In this manual, the safety instructions are ranked as "DANGER" and "CAUTION".



Indicates that incorrect handling may cause hazardous conditions, resulting in death or severe injury.



Indicates that incorrect handling may cause hazardous conditions, resulting in medium or slight personal injury or physical damage.

Note that the  **CAUTION** level may lead to a serious consequence according to the circumstances.

Always follow the instructions of both levels because they are important to personal safety.

Please save this manual to make it accessible when required and always forward it to the end user.

[DESIGN PRECAUTIONS]



- Please refer to the manual for each data link concerning the operating status of each station when communications errors occur in the data link. There is danger of accidents due to wrong outputs or wrong operations.
- When connecting a peripheral device to the CPU module or performing control of a PLC which is being run through a BASIC program, configure an interlock circuit in the sequence program so that the system overall is operating on the safe side at all times. Also, when performing other control (program modifications, changing the operating status (status control)) of a PLC that is currently running, read the manual thoroughly and proceed only after taking adequate safety precautions. Particularly in cases where the above control is performed toward PLC in remote locations from the opposite party's device, there may be occasions where it is impossible to respond immediately to trouble on the PLC side resulting from data communications errors. At the same time as you are configuring an interlock circuit in the sequence program, decide methods for the system to use to treat data communications errors between the opposite party's device and the PLC CPU.

[DESIGN PRECAUTIONS]

DANGER

- Do not write data to the "System Area" in the intelligent function module's buffer memory. Also, do not turn the output for signals for "Use Prohibited" signals among the output signals from the PLC CPU to the intelligent function module (ON). If data are written to the "System Area" or output in response to "Use Prohibited" signals, there is danger that the PLC system will malfunction.

CAUTION

- Do not bunch the control wires or communication cables with the main circuit or power wires, or install them close to each other. They should be installed 100mm (3.94 in.) or more from each other. Not doing so could result in noise that may cause malfunction.
- If a BASIC program is registered in the EEPROM in the module, do not perform a power OFF or PLC CPU reset operation at the station where the module is installed during registration. If a power OFF or PLC CPU reset operation is performed at the station where the module is installed during registration, the data contents in the EEPROM will be indefinite and it will be necessary to reset the setting values, etc. in the buffer memory and register them again in the EEPROM. It could also cause the module to break down or malfunction.

[INSTALLATION PRECAUTIONS]

CAUTION

- Use the PLC in an environment that meets the general specifications contained in the user's manual of the CPU module to use. Using this PLC in an environment outside the range of the general specifications may cause electric shock, fire, malfunction, and damage to or deterioration of the product.
- Insert the module fixing projection into the fixing hole in the base unit to press the module using the hole as the fulcrum, and then tighten the fixing screw with the specified torque.
When no screw is tightened, even if the module is installed correctly, it may cause malfunctions, a failure or a drop of the module.
- Tighten the screws within the range of specified torque. If the screws are loose, it may cause the module to fallout, short circuits, or malfunction. If the screws are tightened too much, it may cause damage to the screw and/or the module, resulting in fall out, short circuits or malfunction.
- Shut off all phases of the external power supply in the system before mounting or dismounting the module. Failure to do so may damage the product.
- Do not directly touch the conductive area or electronic components of the module. Doing so may cause malfunction or failure in the module.

[WIRING PRECAUTIONS]

CAUTION

- If the module is turned on and operated after installation or wiring operations, etc., be sure install the terminal cover provided with this product. If the terminal cover is not installed, there is danger of malfunction.
- When connecting wires to the connector used for external connections, be sure to crimp, pressure weld or solder the wires correctly using the tool specified by the manufacturer.
If connections are not perfect, it could result in short circuits, fire or malfunction.
- Securely insatll the connector to the module.
- Be sure to fix communication cables leading from the module by placing them in the duct or clamping them.
Cables not placed in the duct or without clamping may hang or shift, allowing them to be accidentally pulled, which may cause a module malfunction and cable damage.
- When connecting cables, be sure to do so correctly after confirming the type of interface you are connecting to. If connection is made to a different interface or if wiring is faulty, it could cause the module or external device to break down.
- Tighten the terminal screws within the range of specified torque.
If the terminal screws are loose, it may result in short circuits or malfunction.
If the screws are tightened too much, it may cause damage to the screw and/or the module, resulting in the module falling out, short circuits or malfunction.
- When disconnecting the communications cable or power cable that is connected to the module, do not disconnect it by grasping the cable with your hand and pulling it.
Disconnect cables with connectors attached by taking hold of the connector at the connection with the module and pulling the connector. For cables connected to a terminal block, remove the cable after loosening the terminal block screws.
If the cable is pulled while it is connected to the module, it could cause malfunction or damage the module or the cable.
- Be careful not to let foreign objects such as swarf or wire chips get inside the module.
They may cause fires, failure or malfunction.

[STARTING AND MAINTENANCE PRECAUTIONS]

CAUTION

- Do not disassemble or modify the each module.
Doing so could cause failure, malfunction injury or fire.
- Shut off all phases of the external power supply in the system before mounting or dismounting the module. Failure to do so may cause failure or malfunction of the module.
- Do not touch the connector while the power is on.
Doing so may cause malfunction.
- Shut off all phases of the external power supply in the system before cleaning or retightening the terminal screws or module fixing screws.
Not doing so may cause failure or malfunction of the module.
If the screws are loose, it may cause the module to fallout, short circuits, or malfunction.
If the screws are tightened too much, it may cause damages to the screws and or/the module, resulting in fall out, short circuits or malfunction.
- Always make sure to touch the grounded metal to discharge the electricity charged in the body, etc., before touching the module.
Failure to do so may cause a failure or malfunctions of the module.

[OPERATING PRECAUTIONS]

CAUTION

- When performing control (in particular, changing data, changing a program or changing the operation status (status control)) of the PLC during operation using a BASIC program, do so only after reading the user's manual thoroughly and taking adequate safety precautions.
If there are errors when changing data, changing a program or in status control, it could result in system malfunction, or cause mechanical damage or accidents.

[DISPOSAL PRECAUTIONS]

CAUTION

- When disposing of this product, treat it as industrial waste.

Revisions

*The manual number is noted at the lower right of the top cover.

Print Date	*Manual Number	Revision
Sep., 2005	IB(NA)-0800311-A	First printing

This manual confers no industrial property rights or any rights of any other kind, nor does it confer any patent licenses. Mitsubishi electric Corporation cannot be held responsible for any problems involving industrial property rights which may occur as a result of using the contents noted in this manual.

© 2005 MITSUBISHI ELECTRIC CORPORATION

CONTENTS

1. Overview	1
2. Performance Specifications.....	2
2.1 Performance Specifications	2
2.2 Connector Specifications	4
2.2.1 RS-232C interface (CH1/CH2)	4
2.2.2 RS-422/485 interface (CH3).....	5
3. Loading and Installation	6
3.1 Precautions for handling	6
3.2 Installation conditions	6
4. External Wiring.....	7
4.1 RS-232C Connection.....	7
4.2 RS-422/485 Connection	8
5. Part Names And Setting.....	9
6. External Dimensions	15

About the Manuals

The following product are available for this equipment.
Refer to the table given below to choose suitable manuals.

Related Manual

Manual name	Manual No. (Model code)
Type A1SD51S Intelligent Communication Module User's Manual	IB-66551 (13JE90)
AD51H-BASIC Programming Manual (Command) (For QD51(-R24),A1SD51S,AD51H-S3)	SH-080090 (13JF63)
AD51H-BASIC Programming Manual (Debug and Compile) (For QD51(-R24),A1SD51S,AD51H-S3)	SH-080091 (13JF64)
AD51H-BASIC Package Type SW11VD-AD51HP-E (For QD51(-R24),A1SD51S,AD51H-S3) Operating Manual	IB-66698 (13J910)

Conformation to the EMC Directive and Low Voltage Instruction

For details on making Mitsubishi PLC conform to the EMC directive and low voltage instruction when installing it in your product, please see Chapter 3, "EMC Directive and Low Voltage Instruction" of the User's Manual (Hardware) of the CPU module to use or that of the PLC CPU included with base unit. The CE logo is printed on the rating plate on the main body of the PLC that conforms to the EMC directive and low voltage instruction. By making this product conform to the EMC directive and low voltage instruction, it is not necessary to make those steps individually.

1. Overview

This manual explains the specifications and part names of the A1SD51S intelligent communication module that is used in combination with the MELSEC-A series compact building block type PLC CPU.

After unpacking, make sure that the following is included.

Model	Product name	Quantity
A1SD51S	A1SD51S intelligent communication module	1

2. Performance Specifications

2.1 Performance Specifications

Item		Specification
Programming language		• AD51H-BASIC
Number of tasks		• Max. two tasks
Conditions for starting tasks		<ul style="list-style-type: none"> • Started by power ON • Started by an interrupt from the PC CPU (Not started in Compile BASIC) • Started by the start command from another task
Internal memory		• Program memory: Max. 64 K bytes/two takes (Tasks size can be set to 16K, 32K, 48K or 64K bytes)
		• Common memory: 8 K bytes
		• Expansion register: 1024 points (2 K bytes)
		• Expansion relay: 1024 points
General-purpose I/O		<ul style="list-style-type: none"> • Input: 27 points • Output: 23 points
Buffer		• 3 K words (6 K bytes)
Built-in interfaces	RS-422/485 I/F	• Conforms to RS-422 Channel 3 Used with a connector Transmission distance: within 500m
	RS-232C I/F	• Conforms to RS-232C Channels 1 and 2 Used with a connector Transmission distance: within 15m
Memory backup		• Backup capability provide (common memory, extension relay, extension register) *1
Writing a user program to the ROM		• Disabled (However, a built-in EEPROM is installed in the body of the A1SD51S.) *2
Console		<ul style="list-style-type: none"> • PC/AT • VG-620 (manufactured by Victor Data Systems) • VT-382 (manufactured by the Japan Digital Equipment Inc.)
Number of occupied I/O points		• 32 points
5V DC Internal current consumption		• 0.4A
External dimensions		• 130 (5.12)(H)×34 (1.39)(W) ×93.6 (3.69)(D) [mm(in.)]
Weight		• 0.3 kg (0.66 lb)

For general specifications, refer to the user's manual of your CPU module.

*1 Precautions for data backup

When data is backed up using the common memory, extended register (ED) and extended relay (EM), be careful for the following points. When data is cleared at the A1SD51S start-up (SW9 is ON), the installation position is not limited.

(1) Module installation position

Install A1SD51S at the final slot of the main base or the extension base. (Make sure that the right side of A1SD51S has no module or blank cover (A1SG60).)

Note

A1SD51S uses the super-capacitor (capacitor) for backup.
When the super-capacitor is used at a high temperature, the backup time becomes short. To reduce the temperature of the super-capacitor, be sure to observe the installation position.
The super-capacitor has a life span.
When exceeding its life span, replace the super-capacitor.

(2) Backup time

MIN. 48 hours (assurance value)

TYP. 120 hours (practical value)

(3) Other items

(a) If backup exceeding the backup time is required, backup the data with the PLC CPU.

(A program that transfers data with the PLC CPU is required.)

(b) The charging time of the super-capacitor is one hour.

(When the charging time is less than 1 hour, the backup time is short.)

(c) The life of the super-capacitor is shown in the diagram below. When the super-capacitor exceeds the service life (total power supply time) below, replace the super-capacitor. (When replacing a super-capacitor, please consult your local Mitsubishi service or representative. When requesting replacement, store the data of the common memory, extended register (ED) and extended relay (EM).)

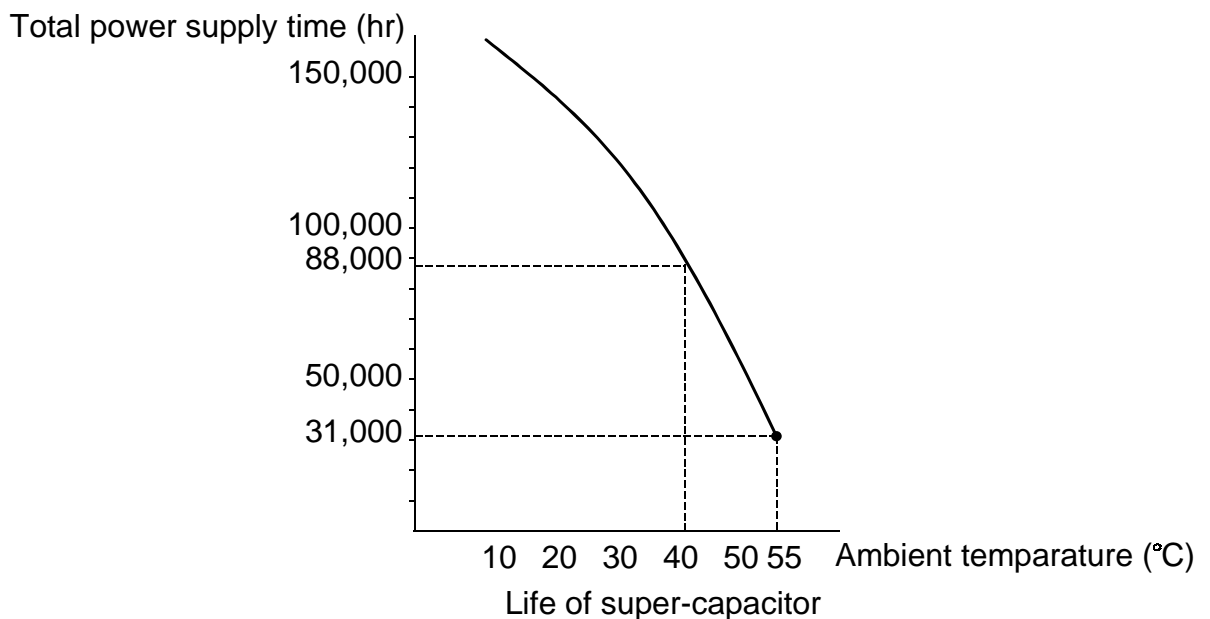

*2 The EEP-ROM can be rewritten 10000 times.

Rewriting is performed with the following system commands:

- MSAVE
- SET

2.2 Connector Specifications

2.2.1 RS-232C interface (CH1/CH2)

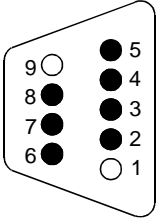
Item		Specification				
Applicable device	Debugger port	VG-620, VT-382, PC/AT				
	Console port	(Console port is CH1 only.)				
	General -purpose port	External devices with the RS-232C interface				
Transmission method		Conforms to RS-232C				
Synchronization method		Asynchronous system				
Transmission specification settings	Transmission speed	Selectable from 300, 600, 1200, 2400, 4800, 9600 and 19200bps				
	Parity bit	Yes or no (odd parity/even parity)				Selectable
	Stop bit	1, 1.5, 2 bits				
	Character data bit	5, 6, 7, 8 bits				
Communication control		DTR/DSR(ER/DR) control or DC code control				
Connector of the A1SD51S	Model	17JE-13090-02(D8A) manufactured by DDK				
	Pin arrangement and pin numbers	End view of connector	Pin No.	Signal abbreviation	Signal name	Signal direction A1SD51S ↔ External device
			2	RD(RXD)	Receive data	←
			3	SD(TXD)	Send data	→
			4	ER(DTR)	Data terminal ready	→
			5	SG	Signal ground	↔
			6	DR(DSR)	Dataset ready	←
			7	RS(RTS)	Request to send	→
			8	CS(CTS)	Clear to send	←

2.2.2 RS-422/485 interface (CH3)

Item		Specification				
Applicable device	Debugger port	PC/AT				
	Console port					
	General -purpose port	External devices with the RS-422/485 interface				
Transmission method		Conforms to RS-422				
Synchronization method		Asynchronous system				
Transmission specification settings	Transmission speed	Selectable from 300, 600, 1200, 2400, 4800, 9600 and 19200bps				
	Parity bit	Yes or no (odd parity/even parity)			Selectable	
	Stop bit	1, 1.5, 2 bits				
	Character data bit	5, 6, 7, 8 bits				
	Communication control		CS(CTS) control			
Connector of the A1SD51S	Model	17L-10250-27-D9A manufactured by DDK				
	Pin arrangement and pin numbers	End view of connector	Pin No.	Signal abbreviation	Signal name	Signal direction A1SD51S ↔ External device
			2	RDA	Receive data	←
			15	RDB		
			3	SDA	Send data	→
			16	SDB		
			4	RSA	Request to send	→
			17	RSB		
			5	CSA	Clear to send	←
			18	CSB		
			20	SG	Signal ground	↔
			21	RR *1	Receive ready	←
Note	*1: To enable data reception by the A1SD51S, be sure to connect RR (receive ready) to both the SG (No.20 pin) of the A1SD51S and the SG of the external device as shown above.					

(1) Function block diagram

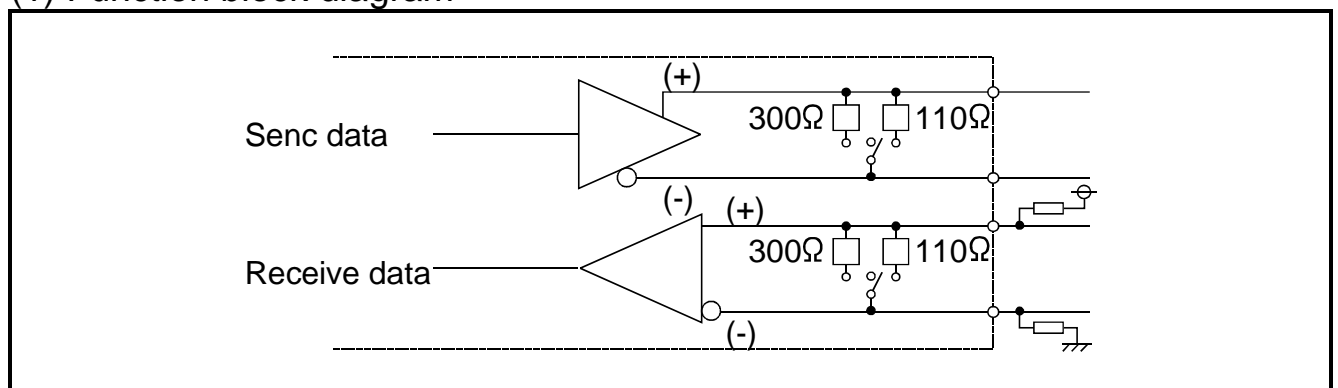

3. Loading and Installation

3.1 Precautions for handling

- (1) Since the module case is made of resin, do not drop it or subject it to shock.
- (2) Do not remove the PC board from the module case. This may cause a fault.
- (3) Take precautions to prevent wire scraps or foreign material from falling into the top of the module.
- (4) Tighten the module mounting screws (usually unnecessary) with a torque in the following range:

Screw	Tightening Torque Range
Module mounting screw (usually unnecessary) (M4×0.7 screw)	78 to 118N•cm

- (5) Load the module to the base with its hooks completely engaged with the base.
To remove the module, first disengage the hooks from the base, then pull the module toward you.
(For details, refer to the user's manual for a small building block type CPU.)

3.2 Installation conditions

Do not install the A1SD51S in the following locations.

- (1) Locations where the ambient temperature is outside the range 0°C to 55°C.
- (2) Locations where the ambient humidity is outside the range 10% RH to 90% RH.
- (3) Locations where dewing occurs due to sudden temperature changes.
- (4) Locations exposed to corrosive or combustible gases.
- (5) Locations exposed to large amounts of highly conductive dust, iron powder, oil mist, salt or organic solvents.
- (6) Locations where the module is exposed to direct sunlight.
- (7) Locations where a strong electric or magnetic field is generated.
- (8) Locations where the module will be subject to direct vibration or impact.

4. External Wiring

4.1 RS-232C Connection

The standard method for the RS-232C cable connection is indicated below. For details on the connection method, refer to the user's manual of the A1SD51S intelligent communication module.

(1) External wiring example for DTR/DSR (ER/DR) control or DC code control

A1SD51S		Cable Connection and Signal Direction (Connection Example)	External Device
Signal	Pin No.		Signal
RD(RXD)	2		RD(RXD)
SD(TXD)	3		SD(TXD)
ER(DTR)	4		ER(DTR)
SG	5		SG
DR(DSR)	6		DR(DSR)
RS(RTS)	7		RS(RTS)
CS(CTS)	8		CS(CTS)

For this wiring, enable the DC code control or DTR/DSR (ER/DR) control with Processing Code 18 of the ZCNTL command.

(2) External wiring example for DC code control

A1SD51S		Cable Connection and Signal Direction (Connection Example)	External Device
Signal	Pin No.		Signal
RD(RXD)	2		RD(RXD)
SD(TXD)	3		SD(TXD)
ER(DTR)	4		ER(DTR)
SG	5		SG
DR(DSR)	6		DR(DSR)
RS(RTS)	7		RS(RTS)
CS(CTS)	8		CS(CTS)

For this wiring, enable the DC code control with Processing Code 18 of the ZCNTL command.

4.2 RS-422/485 Connection

The standard method for one-to-one (1:1) connection of the RS-422/485 cable is indicated below.



A1SD51S		Cable Connection and Signal Direction (Connection Example)	External Device
Signal	Pin No.		Signal
SDA	3		RDA
SDB	16		RDB
RDA	2		SDA
RDB	15		SDB
CSA	5		RSA
CSB	18		RSB
RSA	4		CSA
RSB	17		CSB
RR	21		-
SG	20		SG

For the terminating resistor setting and an external wiring example for multi-drop (1:n) connection, refer to the user's manual of the A1SD51S intelligent communication module.

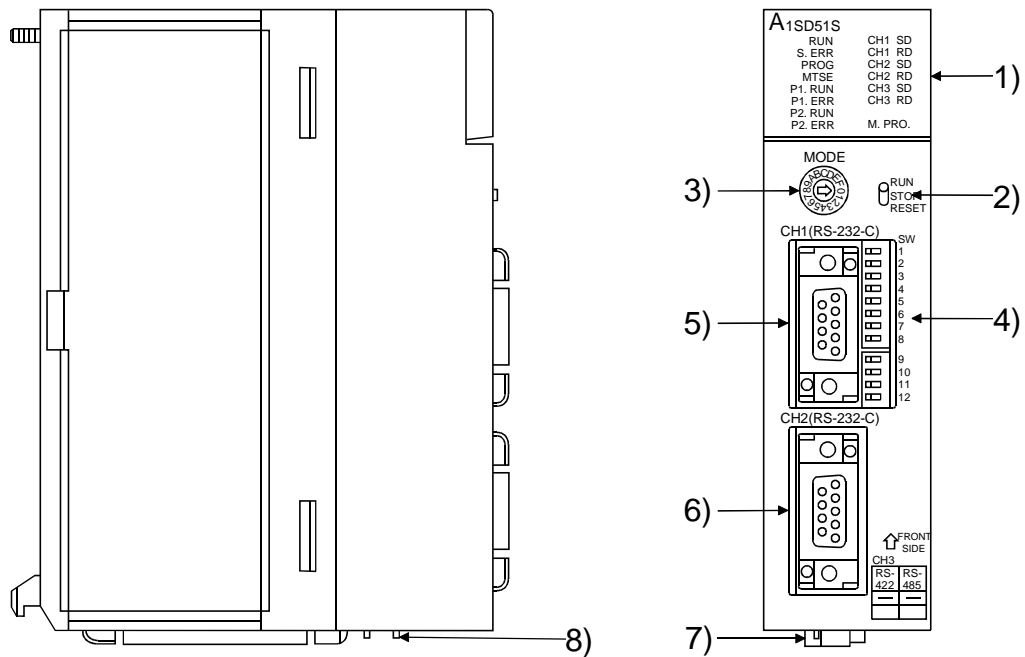
5. Part Names And Setting



No.	Name	Description	
(1)	RUN CH1 SD S. ERR CH1 RD PROG CH2 SD MTSE CH2 RD P1. RUN CH3 SD P1. ERR CH3 RD P2. RUN P2. ERR M. PRO.	RUN	Normal operation Normal: ON Error: OFF
		S.ERR	System error Normal: OFF Error: ON
		PROG	Programming mode In programming mode: ON
		MTSE	Multitask setting error Setting error occurred: ON
		P1.RUN	Task 1 execution Task 1 being executed: ON
		P1.ERR	Task 1 error Error occurred in task 1: ON
		P2.RUN	Task 2 execution Task 2 being executed: ON
		P2.ERR	Task 2 error Error occurred in task 2: ON
		CH1 SD	CH1 send status Data being sent: Flashing
		CH1 RD	CH1 receive status Data being received: Flashing
		CH2 SD	CH2 send status Data being sent: Flashing
		CH2 RD	CH2 receive status Data being received: Flashing
		CH3 SD	CH3 send status Data being sent: Flashing
		CH3 RD	CH3 receive status Data being received: Flashing
		M.PRO.	Memory protect status Memory protected (when SW10 is ON): ON

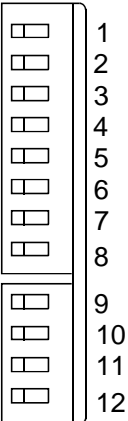





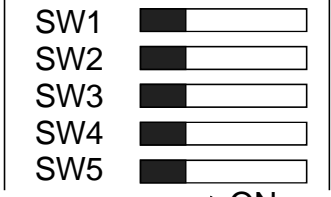
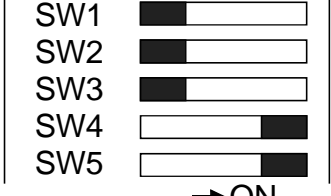
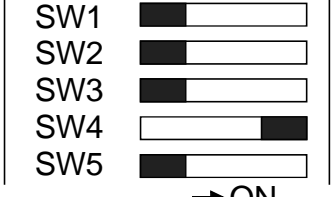
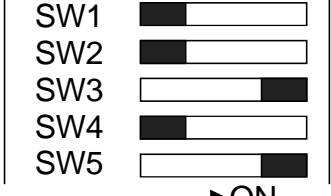
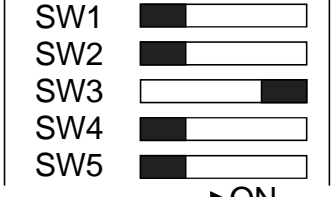

No.	Name	Description			
(2)	RUN switch 	Used to execute/stop tasks or to reset the hardware. •RUN : Executes tasks. (Enabled only in execution/debugging mode) •STOP : Stops tasks. (Enabled only in execution/debugging mode) •RESET : Resets the hardware.			
(3)	Mode setting switch 1 MODE 	Mode setting (Factory setting: 0)			
		Mode	Description		
		0	Execution mode		
		1			
		2	Multitask debugging mode		
		3			
		4	Programming mode		
5 to F	Use not allowed				
(4)	Mode setting switch 2 	Consol and other settings			
		SW	Setting	Status	
				ON	OFF
		1	Console/Debugger port setting	Refer to *1	
		2			
		3			
		4			
		5			
		6	BASIC program stop by pressing [Break] key or [Ctrl] + [C] keys	Enabled	Disabled
		7	PLC CPU reset	Enabled	Disabled
		8	Accessible time after PLC CPU reset	2000ms	200ms
		9	Backup area clear	Cleared at startup	Not cleared
		10	EER-ROM write protect setting	Protected	Not protected
11	Not used	-	-		
12					

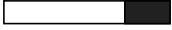
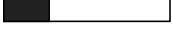
*1 Consol/debugger port setting

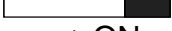
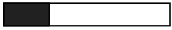
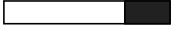
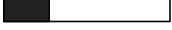
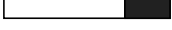
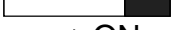
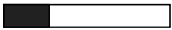
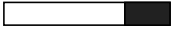
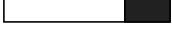
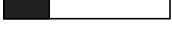
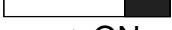

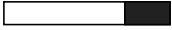
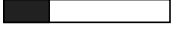

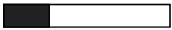
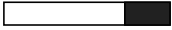
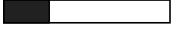
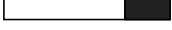
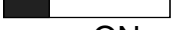
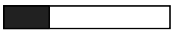
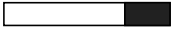
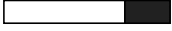
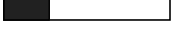

(1) When connecting console to CH3

Console	Debugger	Setting
The following is connected to CH3: • PC/AT	Not connected	 <p style="text-align: right;">→ ON</p>
	The following is connected to CH1: • VT-382 • PC/AT	 <p style="text-align: right;">→ ON</p>
	The following is connected to CH1: • VG-620	 <p style="text-align: right;">→ ON</p>
	The following is connected to CH2: • VT-382 • PC/AT	 <p style="text-align: right;">→ ON</p>
	The following is connected to CH2: • VG-620	 <p style="text-align: right;">→ ON</p>

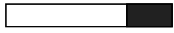
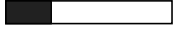
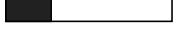
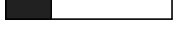
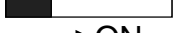
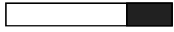
(2) When connecting console to CH1

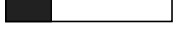
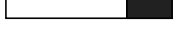
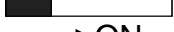
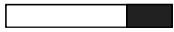
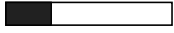
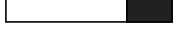
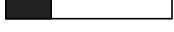
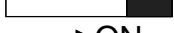
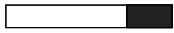
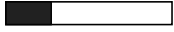
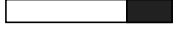
Consol	Debugger	Setting
The following is connected to CH1: • VT-382 • PC/AT	Not connected	SW1  SW2  SW3  SW4  SW5  → ON
	The following is connected to CH3: • PC/AT	SW1  SW2  SW3  SW4  SW5  → ON
	The following is connected to CH2: • VT-382 • PC/AT	SW1  SW2  SW3  SW4  SW5  → ON
The following is connected to CH1: • VG-620	Not connected	SW1  SW2  SW3  SW4  SW5  → ON
	The following is connected to CH3: • PC/AT	SW1  SW2  SW3  SW4  SW5  → ON
	The following is connected to CH2: • VG-620	SW1  SW2  SW3  SW4  SW5  → ON

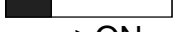
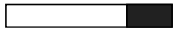
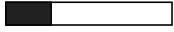
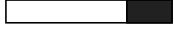
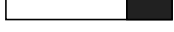
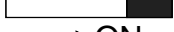
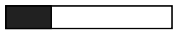
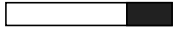
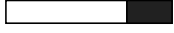
(3) When connecting no console

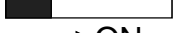
Console	Debugger	Setting
Not connected	Not connected	SW1  SW2  SW3  SW4  SW5  → ON
	The following is connected to CH3: • PC/AT	SW1  SW2  SW3  SW4  SW5  → ON
	The following is connected to CH1: • VT-382 • PC/AT	SW1  SW2  SW3  SW4  SW5  → ON
	The following is connected to CH1: • VG-620	SW1  SW2  SW3  SW4  SW5  → ON
	The following is connected to CH2: • VT-382 • PC/AT	SW1  SW2  SW3  SW4  SW5  → ON
	The following is connected to CH2: • VG-620	SW1  SW2  SW3  SW4  SW5  → ON

No.	Name	Description
(5)	RS-232C interface (CH1)	• A console, debugger or external device, etc. is connected to this.
(6)	RS-232C interface (CH2)	• A debugger or external device, etc. is connected to this.
(7)	RS-422 interface (CH3)	• A console, debugger or external device, etc. is connected to this.
(8)	Terminating resistor selector switch	• Terminating resistor setting for RS-422/485 is selected. RS-422 : 330Ω Neutral : Not connected RS-485 : 110Ω

6. External Dimensions

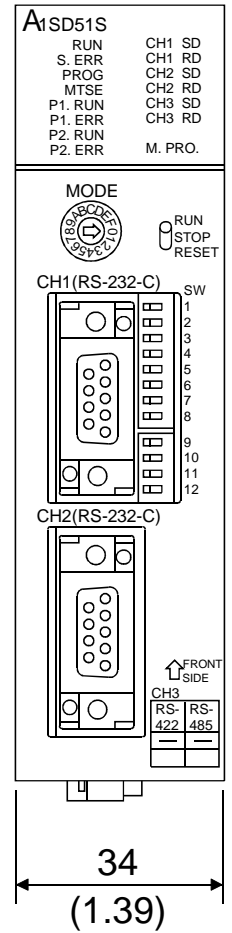
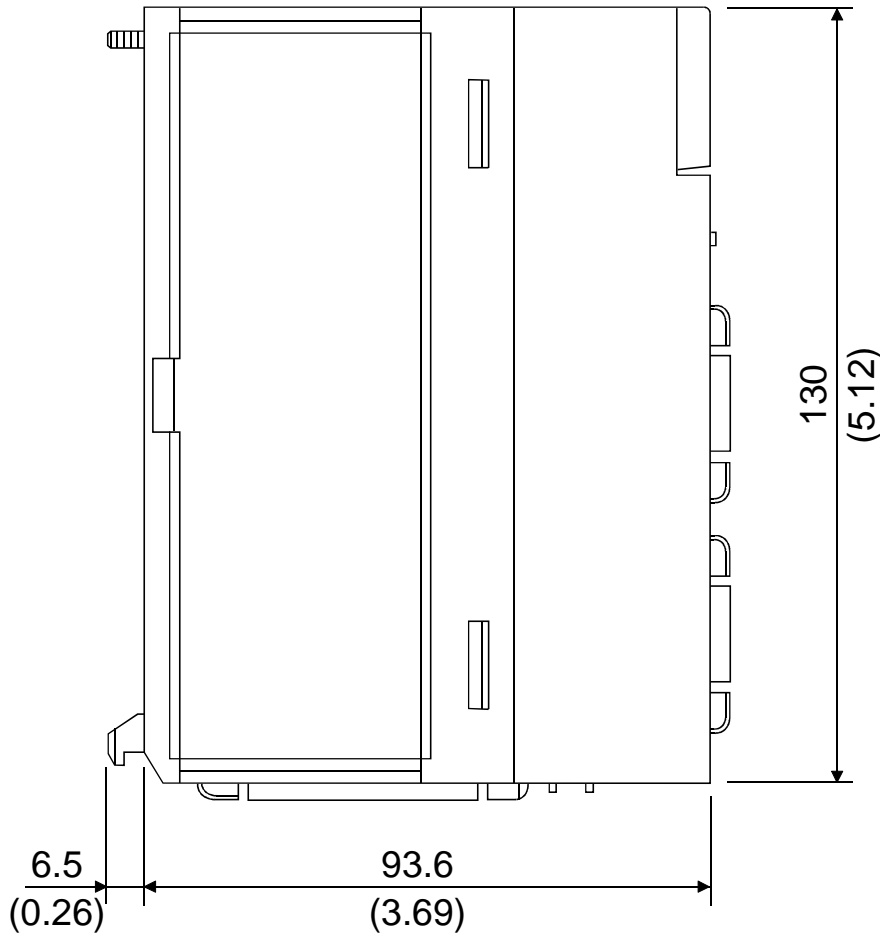

Unit:mm (inch)

Warranty

Mitsubishi will not be held liable for damage caused by factors found not to be the cause of Mitsubishi; machine damage or lost profits caused by faults in the Mitsubishi products; damage, secondary damage, accident compensation caused by special factors unpredictable by Mitsubishi; damages to products other than Mitsubishi products; and to other duties.

⚠ For safe use

- This product has been manufactured as a general-purpose part for general industries, and has not been designed or manufactured to be incorporated in a device or system used in purposes related to human life.
- Before using the product for special purposes such as nuclear power, electric power, aerospace, medicine or passenger movement vehicles, consult with Mitsubishi.
- This product has been manufactured under strict quality control. However, when installing the product where major accidents or losses could occur if the product fails, install appropriate backup or failsafe functions in the system.

Country/Region	Sales office/Tel	Country/Region	Sales office/Tel
U.S.A	Mitsubishi Electric Automation Inc. 500 Corporate Woods Parkway Vernon Hills, IL 60061 Tel : +1-847-478-2100	Hong Kong	Ryoden Automation Ltd. 10th Floor, Manulife Tower, 169 Electric Road, North Point, HongKong Tel : +852-2887-8870
Brazil	MELCO-TEC Rep. Com.e Assessoria Tecnica Ltda. Rua Correia Dias, 184, Edificio Paraiso Trade Center-8 andar Paraiso, Sao Paulo, SP Brazil Tel : +55-11-5908-8331	China	Ryoden Automation Shanghai Ltd. 3F Block5 Building Automation Instrumentation Plaza 103 Cao Bao Rd. Shanghai 200233 China Tel : +86-21-6120-0808
Germany	Mitsubishi Electric Europe B.V. German Branch Gothaer Strasse 8 D-40880 Ratingen, GERMANY Tel : +49-2102-486-0	Taiwan	Setsuyo Enterprise Co., Ltd. 6F., No.105 Wu-Kung 3rd.RD, Wu-Ku Hsiang, Taipei Hsine, Taiwan Tel : +886-2-2299-2499
U.K	Mitsubishi Electric Europe B.V. UK Branch Travellers Lane, Hatfield, Herts., AL10 8XB,UK Tel : +44-1707-276100	Korea	HAN NEUNG TECHNO CO.,LTD. 1F Dong Seo Game Channel Bldg., 660-11, Deungchon-dong Kangsec-ku, Seoul, Korea Tel : +82-2-3660-9552
Italy	Mitsubishi Electric Europe B.V. Italian Branch Centro Dir. Colleoni, Pal. Perseo-Ingr.2 Via Paracelso 12, 20041 Agrate B., Milano, Italy Tel : +39-039-6053344	Singapore	Mitsubishi Electric Asia Pte, Ltd. 307 Alexandra Road #05-01/02, Mitsubishi Electric Building Singapore 159943 Tel : +65-6473-2308
Spain	Mitsubishi Electric Europe B.V. Spanish Branch Carretera de Rubi 76-80 08190 Sant Cugat del Valles, Barcelona, Spain Tel : +34-93-565-3131	Thailand	F. A. Tech Co.,Ltd. 898/28,29,30 S.V.City Building,Office Tower 2,Floor 17-18 Rama 3 Road, Bangkpongpan, Yannawa, Bangkok 10120 Tel : +66-2-682-6522
France	Mitsubishi Electric Europe B.V. French Branch 25 Boulevard des Bouvets, F-92741 Nanterre Cedex, France TEL: +33-1-5568-5568	Indonesia	P.T. Autoteknindo SUMBER MAKMUR Jl. Muara Karang Selatan Block a Utara No.1 Kav. No.11 Kawasan Industri/ Pergudangan Jakarta - Utara 14440 Tel : +62-21-663-0833
South Africa	Circuit Breaker Industries LTD. Tripswitch Drive, Elandsfontein Gauteng, South Africa Tel : +27-11-928-2000	India	Messung Systems Put,Ltd. Electronic Sadan NO:111 Unit No15, M.I.D.C BHOSARI,PUNE-411026, India Tel : +91-20-712-2807
		Australia	Mitsubishi Electric Australia Pty. Ltd. 348 Victoria Road, PostalBag, No 2, Rydalmere, N.S.W 2116, Australia Tel : +61-2-9684-7777

MITSUBISHI ELECTRIC CORPORATION

HEAD OFFICE : 1-8-12, OFFICE TOWER Z 14F HARUMI CHUO-KU 104-6212, JAPAN
NAGOYA WORKS : 1-14, YADA-MINAMI 5-CHOME, HIGASHI-KU, NAGOYA, JAPAN

When exported from Japan, this manual does not require application to the Ministry of Economy, Trade and Industry for service transaction permission.

Specifications subject to change without notice.
Printed in Japan on recycled paper.