

# mitsubishi

## GOT-A900 Series Operating Manual

(SW4D5C-GOTR-PACKE compatible  
Extended•Option Functions Manual)

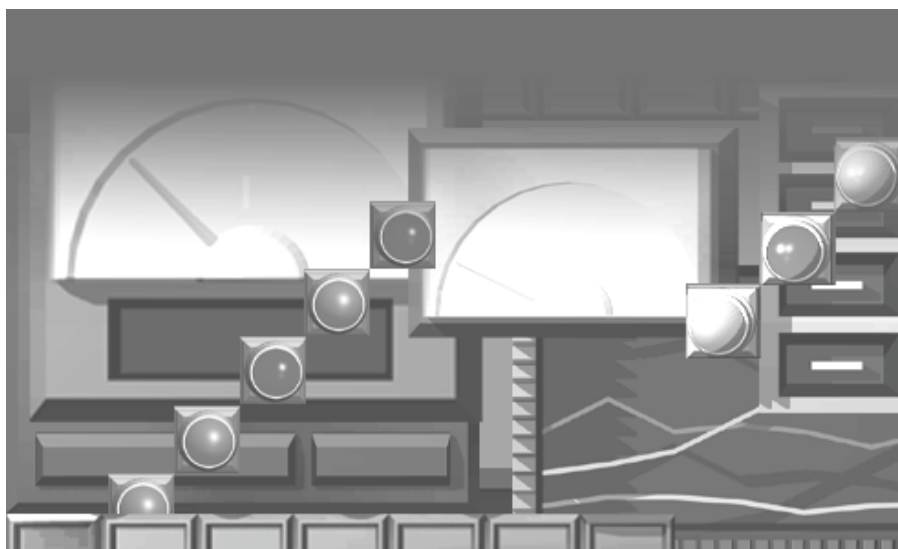

*Graphic Operation Terminal*  
**900**  
series



# • SAFETY PRECAUTIONS •

(Always read these instructions before using this equipment.)

Before using this product, please read this manual and the relevant manuals introduced in this manual carefully and pay full attention to safety to handle the product correctly.

The instructions given in this manual are concerned with this product. For the safety instructions of the programmable controller system, please read the CPU module user's manual.

In this manual, the safety instructions are ranked as "DANGER" and "CAUTION".



Indicates that incorrect handling may cause hazardous conditions, resulting in death or severe injury.

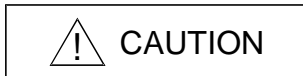

Indicates that incorrect handling may cause hazardous conditions, resulting in medium or slight personal injury or physical damage.

Note that the  CAUTION level may lead to a serious consequence according to the circumstances. Always follow the instructions of both levels because they are important to personal safety.

Please save this manual to make it accessible when required and always forward it to the end user.

## [PRECAUTION WHEN PERFORMING THE TEST OPERATION]

### CAUTION

- Read the manual carefully and fully understand the operation before the test operation (ON/OFF of bit devices, modifying current value of a word device, modifying timer/counter setting, modifying the current value, or modifying the current value of a buffer memory) of system monitor, special function module monitor, and ladder monitor.  
In addition, never modify data in a test operation to a device which performs a crucial operation to the system.  
It may cause an accident by a false output or malfunction.

Revisions

\*The manual number is given on the bottom left of the back cover.

Print Date	*Manual Number	Revision
Jan.,2000	SH(NA)-080069-A	First edition
May.,2000	SH(NA)-080069-B	Partial additions Section 1.2, 4.1, 4.5

This manual confers no industrial property rights or any rights of any other kind, nor does it confer any patent licenses. Mitsubishi Electric Corporation cannot be held responsible for any problems involving industrial property rights which may occur as a result of using the contents noted in this manual.

## INTRODUCTION

Thank you for choosing the Mitsubishi Graphic Operation Terminal.

Before using the equipment, please read this manual carefully to use the equipment to its optimum.

Please forward a copy of this manual to the end user.

### Whereabouts and Usage of This Manual

The manuals relating to SW4D5C-GOTR-PACKE are available in the following types.

The manuals are classified according to their purposes. Please read the proper manuals to understand the handling, operation and functions of the GOT unit and SW4D5C-GOTR-PACKE.

#### [ A985GOT Graphic Operation Terminal User's Manual(Hardware) ]

- To know the features of A985GOT unit.
- To confirm the specifications of A985GOT unit.
- To know the part names of A985GOT unit.
- To know how to install and wire A985GOT unit.
- To know the outline dimension drawing of A985GOT unit.

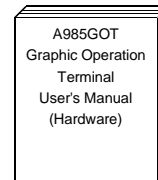

Found in the packing of the A985GOT unit.

#### [ A975GOT-TBA/TBD(-B), A970GOT-TBA/TBD(-B), A970GOT-SBA/SBD, A970GOT-LBA/LBD, A960GOT-EBA/EBD User's Manual(Hardware) ]

- To know the features of A975GOT/A970GOT/A960GOT unit.
- To confirm the specifications of A975GOT/A970GOT/A960GOT unit.
- To know the part names of A975GOT/A970GOT/A960GOT unit.
- To know how to install and wire A975GOT/A970GOT/A960GOT unit.
- To know the outline dimension drawing of A975GOT/A970GOT/A960GOT unit.

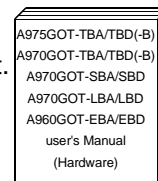

Found in the packing of the A975GOT/A970GOT/A960GOT unit.

#### [ A985GOT-TBA-EU, A975GOT-TBA-EU, A970GOT-TBA-EU, A970GOT-SBA-EU, A960GOT-EBA-EU User's Manual(Hardware) ]

- To know the features of the GOT-A900 series EMC directive Low voltage directive compliant unit.
- To confirm the specifications of the GOT-A900 series EMC directive Low voltage directive compliant unit.
- To know the part names of the GOT-A900 series EMC directive Low voltage directive compliant unit.
- To know how to install and wire the GOT-A900 series EMC directive Low voltage directive compliant unit.
- To know the outline dimension drawing of the GOT-A900 series EMC directive Low voltage directive compliant unit.

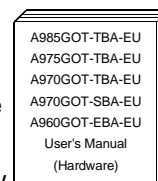

Found in the packing of the A985GOT-TBA-EU, A975GOT-TBA-EU, A970GOT-TBA-EU, A970GOT-SBA-EU, A960GOT-EBA-EU unit.

[ A950GOT-TBD/SBD/LBD (-M3), A951GOT-QTBD/QSBD/QLBD (-M3), A951GOT-TBD/SBD/LBD (-M3), A953GOT-TBD/SBD/LBD (-M3), A956GOT-TBD/SBD/LBD (-M3) User's Manual(Hardware) ]

- To know the features of A950GOT/A951GOT/A953GOT/A956GOT unit.
- To confirm the specifications of A950GOT/A951GOT/A953GOT/A956GOT unit.
- To know the part names of A950GOT/A951GOT/A953GOT/A956GOT unit.
- To know how to install and wire A950GOT/A951GOT/A953GOT/A956GOT unit.
- To know the outline dimension drawing of A950GOT/A951GOT/A953GOT/A956GOT unit.

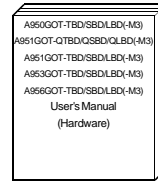

Found in the packing of the A950GOT/A951GOT/A953GOT/A956GOT unit.

[ GOT-A900 Series Option Unit User's Manuals ]

- To know the features of the corresponding GOT-A900 series option unit.
- To confirm the specifications of the corresponding GOT-A900 series option unit.
- To know the part names of the corresponding GOT-A900 series option unit.
- To know the outline dimension drawing of the corresponding GOT-A900 series option unit.

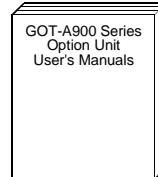

Found in the packing of the corresponding GOT-A900 series option unit.

[ A985GOT/ A975GOT/ A970GOT/ A960GOT User's Manual ]

- To know the features of A985GOT/ A975GOT/ A970GOT/ A960GOT unit.
- To confirm the component devices of A985GOT/ A975GOT/ A970GOT/ A960GOT unit.
- To confirm the specifications of A985GOT/ A975GOT/ A970GOT/ A960GOT unit.
- To know the part names of A985GOT/ A975GOT/ A970GOT/ A960GOT unit.
- To fit various units to A985GOT/ A975GOT/ A970GOT/ A960GOT unit.
- To know how to install and wire A985GOT/ A975GOT/ A970GOT/ A960GOT unit.
- To know how to maintain and inspect A985GOT/ A975GOT/ A970GOT/ A960GOT unit.
- To confirm the error codes of A985GOT/ A975GOT/ A970GOT/ A960GOT unit.
- To know the outline dimension drawing of A985GOT/ A975GOT/ A970GOT/ A960GOT unit.

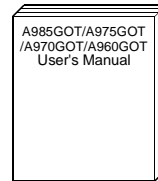

Available as an option.

[ A950GOT/ A951GOT/ A953GOT/ A956GOT User's Manual ]

- To know the features of A950GOT/ A951GOT/ 953GOT/ A956GOT unit.
- To confirm the component devices of A950GOT/ A951GOT/ 953GOT/ A956GOT unit.
- To confirm the specifications of A950GOT/ A951GOT/ 953GOT/ A956GOT unit.
- To know the part names of A950GOT/ A951GOT/ 953GOT/ A956GOT unit.
- To fit various units to A950GOT/ A951GOT/ 953GOT/ A956GOT unit.
- To know how to install and wire A950GOT/ A951GOT/ 953GOT/ A956GOT unit.
- To know how to maintain and inspect A950GOT/ A951GOT/ 953GOT/ A956GOT unit.
- To confirm the error codes of A950GOT/ A951GOT/ 953GOT/ A956GOT unit.
- To know the outline dimension drawing of A950GOT/ A951GOT/ 953GOT/ A956GOT unit.

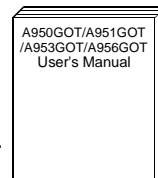

Available as an option.

[ GOT-A900 Series User's Manual(SW4D5C-GOTR-PACKE compatible Connection System Manual) ]

- To know the connection forms available for the GOT-A900 series.
- To confirm the specifications of each connection form.
- To know the system configuration of each connection form.
- To know how to set the unit used.
- To confirm the connection diagrams of the connection cables.

SW4D5C-GOTR-PACKE

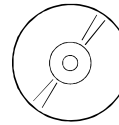

Contained in the SW4D5C-GOTR-PACKE as PDF data.

\* The printed matter is also available as an option.

[ SW4D5C-GOTR-PACKE(V) Operating Manual ]

- To install the software into the personal computer.
- To start each software.
- To know how to connect the personal computer and GOT.
- To know the screen makeup of the software.
- To grasp the outline of various monitoring functions.
- To know the procedure of displaying the monitor screen.
- To know how to use the help function.

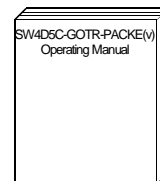

Found in the packing of SW4D5C-GOTR-PACKE.

\* Contained also in the SW4D5C-GOTR-PACKE as PDF data.

[ SW4D5C-GOTR-PACKE Help Functions]

- To confirm how to operate each software of SW4D5C-GOTR-PACKE.
- To confirm how to set various object functions.

SW4D5C-GOTR-PACKE

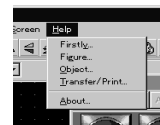

Incorporated in each software of SW4D5C-GOTR-PACKE

[ GOT-A900 Series Operating Manual (SW4D5C-GOTR-PACKE compatible Extended • Option Functions Manual ) ]

- To perform the utility function.
- To perform the system monitoring function.
- To perform the ladder monitoring function.
- To perform the special function unit monitoring function.
- To perform the network monitoring function.
- To perform the list editor function.

SW4D5C-GOTR-PACKE

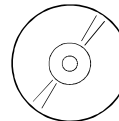

Contained in the SW4D5C-GOTR-PACKE as PDF data.

\* The printed matter is also available as an option.

[ GOT Operations Guide ]

- To learn the sequence of operations by creating a simple screen using the drawing software (the screen displays of the drawing software introduced in the GOT Operations Guide are partly different from those of SW4D5C-GOTR-PACKE).

GOT Operations Guide

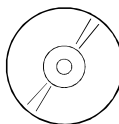

Contained in the GOT Operations Guide.

Abbreviations, generic terms and special terms used in this manual

Abbreviations, generic terms and special terms used in this manual are described as follows:

Abbreviations, generic terms and special terms	Description
A985GOT	Generic term of A985GOT-TBA, A985GOT-TBD and A985GOT-TBA-EU
A975GOT	Generic term of A975GOT-TBA-B, A975GOT-TBD-B, A975GOT-TBA, A975GOT-TBD and A975GOT-TBA-EU
A970GOT	Generic term of A970GOT-TBA-B A970GOT-TBD-B, A970GOT-TBA, A970GOT-TBD, A970GOT-SBA, A970GOT-SBD, A970GOT-LBA, A970GOT-LBD, A970GOT-TBA-EU and A970GOT-SBA-EU
A97*GOT	Generic term of A975GOT and A970GOT
A960GOT	Generic term of A960GOT-EBA, A960GOT-EBD and A960GOT-EBA-EU
A956GOT	Generic term of A956GOT-TBD, A956GOT-SBD, A956GOT-LBD, A956GOT-TBD-M3, A956GOT-SBD-M3 and A956GOT-LBD-M3
A953GOT	Generic term of A953GOT-TBD, A953GOT-SBD, A953GOT-LBD, A953GOT-TBD-M3, A953GOT-SBD-M3 and A953GOT-LBD-M3
A951GOT	Generic term of A951GOT-TBD, A951GOT-SBD, A951GOT-LBD, A951GOT-TBD-M3, A951GOT-SBD-M3 and A951GOT-LBD-M3
A951GOT-Q	Generic term of A951GOT-QTBD, A951GOT-QSBD, A951GOT-QLBD, A951GOT-QTBD-M3, A951GOT-QSBD-M3 and A951GOT-QLBD-M3
A950GOT	Generic term of A950GOT-TBD, A950GOT-SBD, A950GOT-LBD, A950GOT-TBD-M3, A950GOT-SBD-M3 and A950GOT-LBD-M3
A950 handy GOT	Generic term of A953GOT-SBD-M3-H and A953GOT-LBD-M3-H
A95*GOT	Generic term of A956GOT, A953GOT, A951GOT, A951GOT-Q, A950GOT and A950 handy GOT
GOT	Generic term of A985GOT, A97*GOT, A960GOT and A95*GOT
Memory	Abbreviation of memory (flash memory) in the GOT
OS	Abbreviation of GOT system software
A9GT-QBUSS	Abbreviation of A9GT-QBUSS type bus connection board
A9GT-QBUS2S	Abbreviation of A9GT-QBUS2S type multi-drop bus connection board
A9GT-BUSS	Abbreviation of A9GT-BUSS type bus connection board
A9GT-BUS2S	Abbreviation of A9GT-BUS2S type multi-drop bus connection board
Bus connection board	Generic term of A9GT-QBUSS, A9GT-QBUS2S, A9GT-BUSS and A9GT-BUS2S
A9GT-RS4	Abbreviation of A9GT-RS4 type serial communication board
A9GT-RS2	Abbreviation of A9GT-RS2 type serial communication board
A9GT-RS2T	Abbreviation of A9GT-RS2T type serial communication board
Serial communication board	Generic term of A9GT-RS4, A9GT-RS2 and A9GT-RS2T
Communication board	Generic term of bus connection board and serial communication board
A9GT-QBUS2SU	Abbreviation of A9GT-QBUS2SU type multi-drop bus connection unit
A9GT-BUSSU	Abbreviation of A9GT-BUSSU type bus connection unit
A9GT-BUS2SU	Abbreviation of A9GT-BUS2SU type multi-drop bus connection unit
A7GT-BUSS	Abbreviation of A7GT-BUSS type bus connection unit
A7GT-BUS2S	Abbreviation of A7GT-BUS2S multi-drop bus connection unit
Bus connection unit	Generic term of A9GT-QBUS2SU, A9GT-BUS2SU, A9GT-BUS2SU, A7GT-BUSS and A7GT-BUS2S
A7GT-J71AP23	Abbreviation of A7GT-J71AP23 type data link unit
A7GT-J71AR23	Abbreviation of A7GT-J71AR23 type data link unit
A7GT-J71AT23B	Abbreviation of A7GT-J71AT23B type data link unit
Data link unit	Generic term of A7GT-J71AP23, A7GT-J71AR23 and A7GT-J71AT23B
A7GT-J71LP23	Abbreviation of A7GT-J71LP23 type network unit
A7GT-J71BR13	Abbreviation of A7GT-J71BR13 type network unit
Network unit	Generic term of A7GT-J71LP23 and A7GT-J71BR13
A8GT-J61BT13	Abbreviation of A8GT-J61B13 CC-Link communication unit
A8GT-J61BT15	Abbreviation of A8GT-J61B15 CC-Link communication unit
CC-Link communication unit	Generic term of A8GT-J61BT13 and A8GT-J61BT15
Communication unit	Generic term of bus connection unit, data link unit, network unit and CC-Link communication unit
Protection sheet	Abbreviation of A9GT-80PSC, A9GT-70PSC, A9GT-60PSC and A9GT-50PSC type transparent protection sheets
Backlight	Abbreviation of A9GT-80LTT, A9GT-70LTTB, A9GT-70LTT, A9GT-70LTS and A9GT-50LT type backlights
Debug stand	Abbreviation of A9GT-80STAND, A9GT-70STAND and A9GT-50STAND type debug stand
PC card ( memory card )	Abbreviation of PC card with PCMCIA Ver.2.1
Memory board	Abbreviation of A9GT-FNB, A9GT-FNB1M, A9GT-FNB2M, A9GT-FNB4M, A9GT-FNB8M, A9GT-QFNB, A9GT-QFNB4M, A9GT-QFNB8M type option function memory board

Abbreviations, generic terms and special terms	Description
External I/O unit	Abbreviation of A9GT-70KBF and A8GT-50KBF type external I/O interface unit
Printer interface unit	Abbreviation of A9GT-50PRF type printer interface unit
Memory card interface unit	Abbreviation of A1SD59J-MIF memory card interface unit
Attachment	Generic term of A77GT-96ATT/A85GT-95ATT/A87GT-96ATT/A87GT-97ATT attachments
QCPU (Q Mode)	Generic term of Q02CPU, Q02HCPU, Q06HCPU, Q12HCPU and Q25HCPU CPU units
QCPU (A Mode)	Generic term of Q02CPU-A, Q02HCPU-A and Q06HCPU-A CPU units
QCPU	Generic term of QCPU (Q Mode) and QCPU (A Mode)
QnACPU (Large Type)	Generic term of Q2ACPU, Q2ACPU-S1, Q3ACPU, Q4ACPU and Q4ARCPU CPU units
QnACPU (Small Type)	Generic term of Q2ASCPU, Q2ASCPU-S1, Q2ASHCPU and Q2ASHCPU-S1 CPU units
QnACPU	Generic term of QnACPU (Large Type) and QnACPU (Small Type)
AnUCPU	Generic term of A2UCPU, A2UCPU-S1, A3UCPU and A4UCPU CPU units
AnACPU	Generic term of A2ACPU, A2ACPU-S1 and A3ACPU CPU units
AnNCPU	Generic term of A1NCPU, A2NCPU, A2NCPU-S1 and A3NCPU CPU units
ACPU (Large Type)	Generic term of AnUCPU, AnACPU and AnNCPU CPU units
A2US(H)CPU	Generic term of A2USCPU, A2USCPU-S1 and A2USHCPU-S1 CPU units
AnS(H)CPU	Generic term of A1SCPU, A1SHCPU, A2SCPU and A2SHCPU CPU units
A1SJ(H)CPU	Generic term of A1SJCPU-S3 and A1SJHCPU CPU units
ACPU (Small Type)	Generic term of A2US(H)CPU, AnS(H)CPU and A1SJ(H)CPU CPU units
ACPU	Generic term of ACPU (Large Type), ACPU (Small Type) and A1FXCPU CPU units
FX0 series	Generic term of FX0 series CPU unit
FX0N series	Generic term of FX0N series CPU unit
FX0S series	Generic term of FX0S series CPU unit
FX1 series	Generic term of FX1 series CPU unit
FX1S series	Generic term of FX1S series CPU unit
FX2 series	Generic term of FX2 series CPU unit
FX2C series	Generic term of FX2C series CPU unit
FX2N series	Generic term of FX2N series CPU unit
FX2NC series	Generic term of FX2NC series CPU unit
FXCPU	Generic term of FX0 series, FX0N series, FX0S series, FX1 series, FX1S series, FX2 series, FX2C series, FX2N series, FX2NC series CPU unit
Motion controller CPU	Generic term of A373UCPU, A373UCPU-S3, A273UCPU, A273UHCPU, A273UHCPU-S3, A171SCPU-S3, A171SHCPU, A172SHCPU CPU unit
FA controller	Generic term of LM610, LM7600, LM8000 CPU unit
Omron PLC	Generic term of C200HS, C200H, C200HX, C200HG, C200HE, CQM1, C1000H, C2000H, CV1000 CPU unit
Yasukawa PLC	Generic term of GL60S, GL60H, GL70H, GL120, GL130, CP-9200SH, CP-9300MS, MP-920, MP-930, CP-9200(H) and PROGIC-8 CPU unit
Allen-Bradley PLC	Generic term of SLC 5/03, SLC 5/04 CPU unit
Sharp PLC	Generic term of JW-21CU, JW-22CU, JW-31CUH, JW-32CUH, JW-33CUH, JW-50CUH, JW-70CUH, JW-100CUH CPU unit
Toshiba PLC	Generic term of T3, T3H CPU unit
SIEMENS PLC	Generic term of SIMATIC S7-300 Series and SIMATIC S7-400 Series CPU unit
Other PLC	Generic term of Omron PLC, Yasukawa PLC, Allen-Bradley PLC, Sharp PLC, Toshiba PLC and SIEMENS PLC CPU unit
SW4D5C-GOTR-PACKE	Generic term of SW4D5C-GOTR-PACKE software package and SW4D5C-GOTR-PACKEV software package
Drawing software	Abbreviation of image creation software GOT Screen Designer for GOT900
Data conversion software	Abbreviation of data conversion software GOT Converter for GOT900
Debug software	Abbreviation of debugging software GOT Debugger
Object	Setting data for dynamic image
Windows95	Abbreviation of Microsoft Windows95 <sup>*1</sup>
Windows98	Abbreviation of Microsoft Windows98 <sup>*1</sup>
Windows NT4.0	Abbreviation of Microsoft Windows NT Workstation 4.0 <sup>*1</sup>
Windows	Generic term of Windows95, Windows98 and Windows NT4.0
Acrobat Reader	Abbreviation of Adobe Acrobat Reader3.0 <sup>*2</sup>
Personal Computer	Windows compatible Personal Computer that can install SW4D5C-GOTR-PACKE

\*1 Microsoft Windows95, Microsoft Windows98 and Microsoft Windows NT Workstation 4.0 are the trademarks of Microsoft Corporation, U.S.

\*2 Adobe and Adobe Acrobat are the trademarks of Adobe Systems Incorporated. (C)1998 Adobe Systems Incorporated. All right reserved.



## Manual

The following manuals related to this product are available. Obtain the manuals as required the according to this table.

- Related manual

Manual name	Manual number (Model code)
A985GOT/A975GOT/A970GOT/A960GOT User's Manual Explains the specifications, general system configuration, component devices, part names, option unit loading methods, installation and wiring methods, maintenance and inspection methods, and error codes of A985GOT/A975GOT/A970GOT/A960GOT unit. (Available as option)	SH-4005 (13JL70)
A950GOT/A951GOT/A953GOT/A956GOT User's Manual Explains the specifications, general system configuration, component devices, part names, option unit loading methods, installation and wiring methods, maintenance and inspection methods, and error codes of A950GOT/A951GOT/A953GOT/A956GOT unit. (Available as option)	SH-080018 (13JL92)
GOT-A900 Series User's Manual (SW4D5C-GOTR-PACKE compatible Connection System Manual) Gives the specifications, system configuration, setting method and connection diagram of each connection form available for the GOT-A900 series. (Available as option)	SH-080070 (13JR11)
GOT-A900 Series Operating Manual (SW4D5C-GOTR-PACKE compatible Extended • Option Functions Manual) Provides the specifications of the utility, system monitoring, ladder monitoring, special function unit monitoring, network monitoring functions and list editor functions available for the GOT-A900 series and how to operate the dedicated monitor screen. (Available as option)	SH-080069 (13J979)
SW4D5C-GOTR-PACKE(V) Operating Manual Deals with how to install and start the SW4D5C-GOTR-PACKE, its system configuration, the screen makeup of the software package, the general description of various monitoring functions, the procedure for displaying the monitor screen on the GOT, and how to use the help function. (Found in the packing of the SW4D5C-GOTR-PACKE)	IB-0800094 (13J978)
A9GT-QBUSS Type Bus Connection Board User's Manual Describes specifications, part names and installation of A9GT-QBUSS. (with A9GT-QBUSS)	IB-0800073 (13JQ75)
A9GT-QBUS2S Type Multi-Drop Bus Connection Board User's Manual Describes specifications, part names and installation of A9GT-QBUS2S. (with A9GT-QBUS2S)	IB-0800074 (13JQ76)
A9GT-QBUS2SU Type Multi-Drop Bus connection unit User's Manual Describes specifications, part names and installation of A9GT- QBUS2SU. (with A9GT- QBUS2SU)	IB-0800083 (13JQ83)
A9GT-BUSSU Type Bus connection unit User's Manual Describes specifications, part names and installation of A9GT-BUSSU. (with A9GT-BUSSU)	IB-0800076 (13JQ78)
A9GT-BUS2SU Type Multi-Drop Bus connection unit User's Manual Describes specifications, part names and installation of A9GT-BUS2SU. (with A9GT-BUS2SU)	IB-0800077 (13JQ79)
A9GT-BUSS Type Bus Connection Board User's Manual Describes specifications, part names and installation of A9GT-BUSS. (with A9GT-BUSS)	IB-68953 (13JM87)
A9GT-BUS2S Type Multi-Drop Bus Connection Board User's Manual Describes specifications, part names and installation of A9GT-BUS2S. (with A9GT-BUS2S)	IB-68954 (13JM88)
A7GT-BUSS Type bus connection unit User's Manual Describes specifications, part names and operation of A7GT-BUSS. (with A7GT-BUSS)	IB-66760 (13JL07)

Manual name	Manual number (Model code)
A7GT-BUS2S Type multi-drop bus connection unit User's Manual Describes specifications, part names and operation of A7GT-BUS2S. (with A7GT-BUS2S)	IB-66761 (13JL08)
A9GT-RS4 Type Serial Communication Board User's Manual Describes specifications, part names and installation of A9GT-RS4. (with A9GT-RS4)	IB-68955 (13JM89)
A9GT-RS2 Type Serial Communication Board User's Manual Describes specifications, part names and installation of A9GT-RS2. (with A9GT-RS2)	IB-68956 (13JM90)
A9GT-RS2T Type Serial Communication Board User's Manual Describes specifications, part names and installation of A9GT-RS2T. (with A9GT-RS2T)	IB-0800022 (13JQ38)
A7GT-J71AP23/R23 Type Data Link Unit User's Manual Describes specifications, part names and installation of A7GT-J71AP23/R23. (with A7GT-J71AP23/R23)	IB-66438 (13JE26)
A7GT-J71AT23B Type Data Link Unit User's Manual Describes specifications, part names and installation of A7GT-J71AT23B. (with A7GT-J71AT23B)	IB-66439 (13JA81)
A7GT-J71LP23/BR13 Type Network Unit User's Manual Describes specifications, part names and installation of A7GT-J71LP23/BR13. (with A7GT-J71LP23/BR13)	IB-66558 (13JE94)
A8GT-J61BT13 Type CC-Link Communication Unit User's Manual Describes specifications, part names and installation of A8GT-J61BT13. (with A8GT-J61BT13)	IB-66838 (13JL56)
A8GT-J61BT15 Type CC-Link Communication Unit User's Manual Describes specifications, part names and installation of A8GT-J61BT15. (with A8GT-J61BT15)	IB-66788 (13JL29)
A9GT-80LTT Type Back light Unit User's Manual Describes specifications, part names and installation of A9GT-80LTT. (with A9GT-80LTT)	IB-80027 (13JQ21)
A9GT-70LTT Type Back light Unit User's Manual Describes specifications, part names and installation of A9GT-70LTT. (with A9GT-70LTT)	IB-68982 (13JM97)
A9GT-70LTS Type Back light Unit User's Manual Describes specifications, part names and installation of A9GT-70LTS. (with A9GT-70LTS)	IB-68984 (13JM99)
A9GT-70LTTB Type Back light Unit User's Manual Describes specifications, part names and installation of A9GT-70LTTB. (with A9GT-70LTTB)	IB-80033 (13JQ25)
A9GT-50LT type backlight User's Manual Describes specifications and operation of A9GT-50LT. (with A9GT-50LT)	IB-0800020 (13JQ29)
A9GT-80STAND User's Manual Describes specifications, part names and installation of A9GT-80STAND. (with A9GT-80STAND)	IB-80028 (13JQ22)
A9GT-70STAND User's Manual Describes specifications, part names and installation of A9GT-70STAND. (with A9GT-70STAND)	IB-68981 (13JM96)
A9GT-50STAND User's Manual Describes specifications and operation of A9GT-50STAND. (with A9GT-50STAND)	IB-0800021 (13JQ30)

Manual name	Manual number (Model code)
Add-on memory board for A9GT-FNB, A9GT-FNB1M, A9GT-FNB2M, A9GT-FNB4M and A9GT-FNB8M type option function Describes specifications, part names and installation of A9GT-FNB (1M/2M/4M/8M). (with A9GT-FNB (1M/2M/4M/8M))	IB-68975 (13JM91)
Add-on memory board for A9GT-QFNB, A9GT-QFNB4M and A9GT-QFNB8M type option function Describes specifications, part names and installation of A9GT-QFNB (4M/8M). (with A9GT- QFNB (4M/8M))	IB-0800051 (13JQ62)
A9GT-70KBF Type External I/O Interface Unit User's Manual Describes specifications, system configurations, part names and installation/wiring methods of A9GT-70KBF. (with A9GT-70KBF)	IB-80018 (13JQ14)
A8GT-50KBF Type External I/O Interface Unit User's Manual Describes specifications, system configurations, part names and installation/wiring methods of A8GT-50KBF. (with A8GT-50KBF)	IB-66787 (13JL28)
A9GT-50PRF type printer interface unit user's manual Describes specifications, system configuration, part names, installation method and external dimensions of A9GT-50PRF. (with A9GT-50PRF)	IB-0800019 (13JQ28)
A8GT-TK Type Numerical Keypad Panel User's Manual Describes specifications, part names and installation of A8GT-TK. (with A8GT-TK)	IB-66832 (13JL51)
A9GT-QCNB Type bus connector conversion box User's Manual Describes specifications, part names and installation of A9GT-QCNB. (with A9GT-QCNB)	IB-0800082 (13JQ82)
A7GT-CNB Type bus connector conversion box User's Manual Describes specifications, part names and installation of A7GT-CNB. (with A7GT-CNB)	BCN-P5138

# CONTENTS

<b>1</b>	<b>OVERVIEW .....</b>	<b>1 - 1 to 1 - 16</b>
1.1	Before getting started with various functions .....	1 - 1
1.2	Precautions before use.....	1 - 1
1.3	Features .....	1 - 6
1.3.1	Features of the utility function.....	1 - 6
1.3.2	Features of the ladder monitor function.....	1 - 8
1.3.3	Features of the system monitor function .....	1 - 10
1.3.4	Features of the special module monitor function .....	1 - 12
1.3.5	Features of the network monitor function.....	1 - 14
1.3.6	Features of the List editor function .....	1 - 16
<b>2</b>	<b>BEFORE BEGINNING OPERATION.....</b>	<b>2 - 1 to 2- 2</b>
2.1	Required equipment .....	2 - 1
<b>3</b>	<b>SPECIFICATIONS .....</b>	<b>3 - 1 to 3 - 18</b>
3.1	Ladder monitor function specifications.....	3 - 1
3.1.1	PLC CPUs to be monitored .....	3 - 1
3.1.2	Access ranges to be monitored .....	3 - 1
3.2	System monitor function specifications .....	3 - 2
3.2.1	PLC CPUs to be monitored .....	3 - 2
3.2.2	Access ranges to be monitored .....	3 - 2
3.2.3	Names of devices to be monitored.....	3 - 2
3.2.4	Precautions when using the system monitor function .....	3 - 2
3.3	Special module monitor function specifications .....	3 - 4
3.3.1	Access ranges to be monitored .....	3 - 4
3.3.2	Special function modules to be monitored .....	3 - 4
3.3.3	Memory capacity required for using the special module monitor function .....	3 - 5
3.3.4	Precautions when using the special module monitor function .....	3 - 6
3.4	Network monitor function specifications.....	3 - 8
3.4.1	Network information to be monitored .....	3 - 8
3.4.2	Access ranges to be monitored .....	3 - 9
3.4.3	Precautions when using the network monitor function .....	3 - 9
3.5	List editor function specifications.....	3 - 10
3.5.1	PLC CPU that allows for list edit.....	3 - 10
3.5.2	Access range that allows for list edit .....	3 - 10
3.5.3	Precautions for List editor function .....	3 - 10
3.5.4	List of key arrangement and key functions.....	3 - 11
3.5.5	Display format on the display.....	3 - 14
3.5.6	List of List editor function .....	3 - 17

<b>4</b>	<b>OPERATING THE UTILITY FUNCTION.....</b>	<b>4 - 1 to 4 - 18</b>
4.1	Utility function table.....	4 - 1
4.2	Selecting the utility function .....	4 - 2
4.3	Selecting the required function on the utility menu screen (Adjusting the brightness/contrast of the monitor screen) .....	4 - 3
4.4	Copying the monitor data/OS data between the internal memory and memory card (Screen & OS copy) ..	4 - 5
4.5	Setting the operating environment of the GOT (Setup).....	4 - 7
4.6	Running diagnostic checks on GOT hardware (self-test).....	4 - 11
4.7	Displaying GOT memory information (memory information).....	4 - 12
4.8	Setting the Clock (Clock) .....	4 - 13
4.9	Displaying the display area cleanup screen (screen cleanup).....	4 - 14
4.10	Changing security levels (security password).....	4 - 15
4.11	Controlling limited access to the utility menu (password).....	4 - 16
4.12	Adjusting the brightness of the monitor screen on the dedicated screen (Brightness adjustment) .....	4 - 17
<b>5</b>	<b>OPERATION PROCEDURES FOR THE LADDER MONITOR FUNCTION.....</b>	<b>5 - 1 to 5 - 2</b>
5.1	Operation procedures before starting ladder monitoring.....	5 - 1
5.2	Operation procedures from display of user-created monitor screen to start of ladder monitoring .....	5 - 2
<b>6</b>	<b>OPERATING THE VARIOUS LADDER MONITOR SCREENS.....</b>	<b>6 - 1 to 6 - 20</b>
6.1	Screen operation and screen changes when monitoring.....	6 - 1
6.1.1	Reading data from the PLC .....	6 - 1
6.1.2	Ladder read operation.....	6 - 7
6.1.3	Using the defect search .....	6 - 10
6.1.4	Changing from one screen to another.....	6 - 13
6.2	Ladder monitor .....	6 - 14
6.2.1	Ladder monitor screen display and key functions.....	6 - 14
6.2.2	Precaution during ladder monitoring .....	6 - 16
6.2.3	Switching the display form (decimal/hexadecimal) and turning the comment display on/off .....	6 - 17
6.2.4	Changing the device value .....	6 - 18
6.2.5	Printing.....	6 - 19
<b>7</b>	<b>ERROR DISPLAY AND HANDLING WITH LADDER MONITORING.....</b>	<b>7 - 1 to 7 - 2</b>
<b>8</b>	<b>OPERATION PROCEDURES FOR THE SYSTEM MONITOR FUNCTION.....</b>	<b>8 - 1 to 8 - 2</b>
8.1	Operation procedures before starting system monitoring .....	8 - 1
8.2	Operation procedures from user-created monitor screen display to start of system monitoring.....	8 - 2

9	OPERATION OF THE VARIOUS SYSTEM MONITOR SCREENS .....	9 - 1 to 9 - 22
9.1	Screen configuration, common operations and changing screens when monitoring.....	9 - 1
9.1.1	Basic screen configuration and key functions (menu) .....	9 - 1
9.1.2	Switching the display form (decimal/hexadecimal) and turning the comment display on/off (FORM) .....	9 - 2
9.1.3	Specifying the monitor station and device (SET) .....	9 - 4
9.1.4	Changing screens .....	9 - 6
9.2	Entry monitor .....	9 - 7
9.2.1	Basic operation.....	9 - 7
9.2.2	Entry monitor screen display and key functions.....	9 - 8
9.2.3	Deleting a registered device .....	9 - 9
9.3	Batch monitor .....	9 - 10
9.3.1	Basic operation.....	9 - 10
9.3.2	Batch monitor screen display and key functions.....	9 - 11
9.4	TC Monitor (monitor of timer and counter).....	9 - 12
9.4.1	Basic operation.....	9 - 12
9.4.2	TC Monitor screen display and key functions .....	9 - 13
9.5	BM Monitor (monitor of buffer memory) .....	9 - 14
9.5.1	Basic operation.....	9 - 14
9.5.2	BM Monitor screen display and key functions.....	9 - 15
9.6	Test.....	9 - 16
9.6.1	Basic operation.....	9 - 16
9.6.2	Quick test function.....	9 - 19
10	ERROR DISPLAY AND HANDLING WITH SYSTEM MONITORING .....	10 - 1 to 10 - 2
11	OPERATION PROCEDURES FOR SPECIAL MODULE MONITOR FUNCTION.....	11 - 1 to 11 - 2
11.1	Operation procedures before starting special module monitoring .....	11 - 1
11.2	Operation procedures from user-created monitor screen display to start of special module monitor .....	11 - 2
12	OPERATION OF EACH SPECIAL MODULE MONITOR SCREEN .....	12 - 1 to 12 - 114
12.1	Screen configuration, common operation and changing screens when monitoring.....	12 - 1
12.1.1	Composition of system configuration screen and key functions .....	12 - 1
12.1.2	Monitor screen configuration and key functions .....	12 - 2
12.1.3	Setting method for remote station monitoring.....	12 - 3
12.1.4	Specifying monitor module and selecting monitor menu.....	12 - 4
12.1.5	Test for special function module.....	12 - 5
12.1.6	Changing the screen.....	12 - 7
12.2	A61LS module monitor .....	12 - 8
12.2.1	Operation monitor .....	12 - 8
12.2.2	I/O monitor.....	12 - 9
12.3	AD61 module monitor .....	12 - 10
12.3.1	Operation monitor .....	12 - 10

12.4	A1SD61 module monitor .....	12 - 11
12.4.1	Operation monitor .....	12 - 11
12.4.2	I/O monitor.....	12 - 12
12.5	A62DA-S1 module monitor.....	12 - 13
12.5.1	Operation monitor .....	12 - 13
12.5.2	Graph monitor .....	12 - 14
12.6	A1S62DA module monitor .....	12 - 15
12.6.1	Operation monitor .....	12 - 15
12.7	A62LS module monitor .....	12 - 16
12.7.1	Operation monitor .....	12 - 16
12.7.2	I/O monitor.....	12 - 17
12.8	A1S62RD module monitor.....	12 - 18
12.8.1	Operation monitor .....	12 - 18
12.8.2	I/O monitor.....	12 - 19
12.8.3	Graph monitor .....	12 - 20
12.9	A1S63DA module monitor .....	12 - 21
12.9.1	Operation monitor .....	12 - 21
12.9.2	Simple loop monitor .....	12 - 22
12.9.3	I/O monitor.....	12 - 23
12.10	A1S64DA module monitor.....	12 - 24
12.10.1	Operation monitor.....	12 - 24
12.10.2	I/O monitor .....	12 - 25
12.10.3	Graph monitor.....	12 - 26
12.11	A68AD module monitor .....	12 - 27
12.11.1	Operation monitor.....	12 - 27
12.11.2	I/O monitor .....	12 - 28
12.11.3	Graph monitor.....	12 - 29
12.12	A1S68AD module monitor.....	12 - 30
12.12.1	Operation monitor.....	12 - 30
12.12.2	I/O monitor .....	12 - 31
12.12.3	Graph monitor.....	12 - 32
12.13	A68ADN module monitor.....	12 - 33
12.13.1	Operation monitor.....	12 - 33
12.13.2	I/O monitor .....	12 - 34
12.13.3	Graph monitor.....	12 - 35
12.14	A68RD module monitor .....	12 - 36
12.14.1	Operation monitor.....	12 - 36
12.14.2	I/O monitor .....	12 - 37
12.14.3	Graph monitor.....	12 - 38
12.15	A1S68DAI, A1S68DAV module monitor.....	12 - 39
12.15.1	Operation monitor.....	12 - 39
12.15.2	I/O monitor .....	12 - 40
12.15.3	Graph monitor.....	12 - 41
12.16	A616AD module monitor .....	12 - 42
12.16.1	Operation monitor.....	12 - 42
12.16.2	Operation monitor (connect No. 0 to connect No. 7 when multiplex module is used).....	12 - 43
12.16.3	I/O monitor .....	12 - 44

12.16.4	Graph monitor.....	12 - 45
12.16.5	Graph monitor (connect No. 0 to connect No. 7 when multiplex module is used).....	12 - 46
12.17	A616DAI, A616DAV module monitor.....	12 - 47
12.17.1	Operation monitor.....	12 - 47
12.17.2	I/O monitor.....	12 - 48
12.17.3	Graph monitor.....	12 - 49
12.18	A616TD module monitor.....	12 - 50
12.18.1	Operation monitor (INPUT 0-F).....	12 - 50
12.18.2	Operation monitor (connect No. 0 to connect No. 7 when multiplex module is used).....	12 - 51
12.18.3	I/O monitor.....	12 - 52
12.18.4	Setting monitor (when A60MXT is used).....	12 - 53
12.18.5	Temperature monitor (connect No. 0 to connect No. 7 when A60MXT is used).....	12 - 54
12.18.6	Graph monitor (INPUT 0-F).....	12 - 55
12.18.7	Graph monitor (connect No.0 to connect No.7 when multiplex module is used).....	12 - 56
12.19	AD70, A1SD70 module monitor.....	12 - 57
12.19.1	Positioning and parameter data monitor.....	12 - 57
12.19.2	Zero return monitor.....	12 - 59
12.19.3	I/O Monitor.....	12 - 60
12.20	A70D module monitor.....	12 - 61
12.20.1	Positioning monitor.....	12 - 61
12.20.2	Zero return monitor.....	12 - 63
12.20.3	Parameter data monitor.....	12 - 65
12.20.4	I/O monitor.....	12 - 67
12.21	AD71 Module monitor.....	12 - 68
12.21.1	Positioning monitor.....	12 - 68
12.21.2	Zero return monitor.....	12 - 69
12.21.3	Parameter data monitor.....	12 - 70
12.21.4	M code comment monitor.....	12 - 71
12.21.5	I/O monitor.....	12 - 72
12.21.6	Positioning data monitor.....	12 - 73
12.22	AD72, A1SD71 module monitor.....	12 - 74
12.22.1	Positioning monitor.....	12 - 74
12.22.2	Zero return monitor.....	12 - 75
12.22.3	Parameter data monitor.....	12 - 76
12.22.4	M code comment monitor.....	12 - 77
12.22.5	I/O monitor.....	12 - 78
12.22.6	Positioning data monitor.....	12 - 79
12.23	AD75, A1SD75 module monitor.....	12 - 80
12.23.1	I/O monitor.....	12 - 80
12.23.2	Operation monitor.....	12 - 81
12.23.3	Basic parameter monitor.....	12 - 82
12.23.4	Extended parameter monitor.....	12 - 84
12.23.5	Zero return parameter monitor.....	12 - 86
12.23.6	Monitoring the error history and warning history.....	12 - 88
12.23.7	Monitoring the error temporary startup history and startup history.....	12 - 89



12.23.8	Monitoring Speed/Position Control .....	12 - 91
12.23.9	Monitoring special startup, jogging, and manual pulser operation .....	12 - 92
12.23.10	Monitoring an origin point return .....	12 - 93
12.23.11	Monitoring axis control data .....	12 - 94
12.23.12	Monitoring the output speed .....	12 - 95
12.23.13	Monitoring the target values and machine values.....	12 - 96
12.23.14	Monitoring external I/O signals and status signals (flags) .....	12 - 97
12.23.15	Monitoring positioning information .....	12 - 98
12.24	AJ71PT32-S3 and A1SJ71PT32-S3 module monitor .....	12 - 99
12.24.1	I/O monitor (I/O mode) .....	12 - 99
12.24.2	Monitoring the link status.....	12 - 100
12.24.3	Monitoring batch refreshing.....	12 - 101
12.24.4	Monitoring separate refreshing .....	12 - 102
12.24.5	Monitoring input and output (expansion mode).....	12 - 103
12.25	AJ71ID1 (ID2)-R4 and A1SJ71ID1 (ID2)-R4 module monitor .....	12 - 104
12.25.1	Action monitor (CH 1 and CH 2) .....	12 - 104
12.25.2	I/O monitor .....	12 - 105
12.25.3	Monitoring set information .....	12 - 106
12.26	A84AD module monitor .....	12 - 107
12.26.1	Action monitor .....	12 - 107
12.26.2	Setting monitor.....	12 - 108
12.26.3	I/O monitor .....	12 - 109
12.26.4	Monitoring graphs.....	12 - 110
12.27	A1S64TCTT(BW)-S1 and A1S64TCRT(BW)-S1 module monitor .....	12 - 111
12.27.1	Operation monitor .....	12 - 111
12.27.2	Alert detail monitor.....	12 - 112
12.27.3	Operation monitor (CH1 to CH4) .....	12 - 113
<b>13</b>	<b>OPERATING I/O MODULE MONITOR SCREENS .....</b>	<b>13 - 1 to 13 - 2</b>
13.1	Specifying the module to be monitored.....	13 - 1
13.2	Monitor screen configuration and key functions .....	13 - 2
<b>14</b>	<b>ERROR DISPLAY AND HANDLING WITH SPECIAL MODULE MONITORING.....</b>	<b>14 - 1 to 14 - 2</b>
<b>15</b>	<b>OPERATING THE NETWORK MONITOR FUNCTION .....</b>	<b>15 - 1 to 15 - 2</b>
15.1	Steps in getting started with the network monitor function .....	15 - 1
15.2	Steps in starting the network monitor function from the user-created monitor screen.....	15 - 2
<b>16</b>	<b>SWITCHING THE NETWORK MONITOR SCREENS .....</b>	<b>16 - 1 to 16 - 2</b>

<b>17 USING THE NETWORK MONITOR SCREENS .....</b>	<b>17 - 1 to 17 - 18</b>
17.1 Own station monitor .....	17 - 1
17.1.1 Display contents and keys functions: own station monitor .....	17 - 1
17.2 Detailed own station monitor .....	17 - 3
17.2.1 Display contents and keys functions: acting as a MELSECNET/B or MELSECNET (II) master station .....	17 - 3
17.2.2 Display contents and keys functions: acting as a MELSECNET/B or MELSECNET (II) local station.....	17 - 4
17.2.3 Display contents and keys functions: acting as a MELSECNET/10 Control station/ordinary Station .....	17 - 5
17.2.4 Display contents and keys functions: acting as a MELSECNET/10 remote master station .....	17 - 8
17.3 Other station monitor .....	17 - 11
17.3.1 Display contents and keys functions: other station monitor menu .....	17 - 11
17.3.2 Display contents and keys functions: other station communication status monitor.....	17 - 12
17.3.3 Display contents and keys functions: other station data link status monitor .....	17 - 13
17.3.4 Display contents and keys functions: other station parameter status monitor.....	17 - 14
17.3.5 Display contents and keys functions: other station CPU action status monitor.....	17 - 15
17.3.6 Display contents and keys functions: other station CPU RUN status monitor.....	17 - 16
17.3.7 Display contents and keys functions: other station loop status monitor.....	17 - 17
<b>18 ERROR DISPLAYS AND COUNTERMEASURES WHEN MONITORING NETWORKS.....</b>	<b>18 - 1 to 18 - 2</b>
<b>19 OPERATION PROCEDURES FOR THE LIST EDITOR FUNCTION .....</b>	<b>19 - 1 to 19 - 6</b>
19.1 Operation procedures before starting the list edit.....	19 - 1
19.2 Operation procedures from user-created monitor screen display to starting list editing .....	19 - 2
19.2.1 Operation of keyword input.....	19 - 3
19.2.2 Selection and operation of mode.....	19 - 5

20	OPERATION OF EDITING SCREEN FOR EACH LIST.....	20 - 1 to 20 - 16
20.1	Basic operation of key input .....	20 - 1
20.1.1	Switching of valid key (function indicated at the upper/lower part of the key) .....	20 - 1
20.1.2	Command input procedures .....	20 - 2
20.1.3	Action if an incorrect key is input .....	20 - 6
20.2	Basic operation of list edit.....	20 - 7
20.2.1	Reading sequence program .....	20 - 7
20.2.2	Changing (overwriting) command .....	20 - 8
20.2.3	Adding (inserting) command.....	20 - 9
20.2.4	Deleting command .....	20 - 10
20.2.5	Using Help function .....	20 - 11
20.3	Operation procedure list of list edit.....	20 - 13
20.3.1	Common operation.....	20 - 13
20.3.2	Operation in Write mode (W).....	20 - 13
20.3.3	Operation in Read mode (R).....	20 - 14
20.3.4	Operation in Insert mode (I).....	20 - 14
20.3.5	Operation in Delete (D) mode.....	20 - 14
20.3.6	Operation in Parameter mode (P) .....	20 - 15
20.3.7	Operation in Other modes (O) .....	20 - 16
21	ERROR DISPLAY AND CORRECTIVE ACTIONS FOR LIST EDIT .....	21 - 1 to 21 - 6
21.1	Error detected with the list editor function.....	21 - 1
21.2	Error of PLC CPU .....	21 - 4
21.3	Error using list editor function on the link system .....	21 - 5
Index	.....	Index - 1 to Index - 3

Chapter1 Overview

This manual that can be used on a GOT with an operating system installed. These functions include the utility function, ladder monitor function, system monitor function, special module monitor function, network monitor function and list editor function.

1.1 Before getting started with various functions

To use in this manual, such as the utility function, ladder monitor function, system monitor function, special module monitor function, and network monitor function, an operating system (OS) for each function must be installed first on your GOT by using drawing software.

To install an OS for your desired function on your GOT, see SW4D5C-GOTR-PACKE(V) Operating Manual (Drawing Software Manual).

1.2 Precautions before use

Precautions before using each function are described as follows:

(1) There are unavailable functions depending on the GOT.

Please note that some functions require extension memory in the GOT unit. Memory is extended according to the following procedures.

For A985GOT/A97\*GOT/A960GOT : Memory board is installed in the GOT.  
 For A95\*GOT : A95\*GOT-\*BD-M3 (memory extension type) is used.

Requirement for memory extension	Function category	Function	A985GOT A97*GOT A960GOT	A95*GOT
Not required	Basic function	Utility function	○	○
	Extension function	System monitor function	○	○
Required	Option function	Ladder monitor function	○	×
		Special unit monitor function	○	×
		Network monitor function	○	○
		List editor function	○	○

○: Applicable ×: Not applicable

(2) Note that some functions are unavailable depending on the connection target CPU and connection form. There are the following restrictions on each function depending on the connection target CPU and connection form.

Refer to Chapter 2 of the GOT-A900 Series User's Manual (SW4D5C-GOTR-PACKE compatible Connection System Manual) for the connectable CPU names and the access range for monitoring per connection form.

POINTS
<p>(1) Ladder monitoring is not available for sub-programs 2 and 3 of the A4UCPU (when connected to the computer link).</p> <p>(2) When the monitoring destination is QnACPU, Q4ARCPU, or Q2ASCPU, the CPU that can perform setup value changes to the timer/counter of the system monitor function and perform device comment displays, is that the CPU which has "9707 B" and later in the date column of the rated plate. When changing the timer/counter setup value and performing the device comment display, use the CPU that is described above.</p> <p>(3) When the GOT is connected to an AnNCPU or AnACPU, the I/O No. to which a data link module or network module is installed cannot be displayed.</p> <p>(4) When the GOT is connected to an AnNCPU or AnACPU, a screen display shows a screen of the MELSECNET II network even when you are connected to the MELSECNET/10 network (the monitor screen shows the display contents of the MELSECNET II).</p>

<Viewing the Rated Plate>

(a) Connection with QCPU

Functions	Ref. Section	QCPU(Q Mode)					QCPU(A Mode)						
		Bus connection	CPU direct connection	Computer link connection	MELSEC NET connection	CC-Link connection	CPU direct connection	Computer link connection	MELSEC NET connection	CC-Link connection			
Utility function	Brightness/contrast adjustment	Adjusting the brightness/contrast of a monitor screen	Section 4.3										
	Message display selection	Selecting a message display.	Section 4.3										
	Screen & OS copy	Copying the screen and OS data between the internal memory and memory card.	Section 4.4										
	Setup	Setting a use environment of the GOT	Section 4.5										
	Self-test	Running diagnostic checks on GOT hardware	Section 4.6			○					○		
	Memory information	Displaying GOT memory information.	Section 4.7										
	Clock	Setting the clock.	Section 4.8										
	Screen cleanup	Displaying the display area cleanup screen.	Section 4.9										
	Password	Defining a password for limited access to the utility menu screen.	Section 4.10										
Ladder monitor function	Ladder monitor	Sequence program monitoring using ladder signals	Section 6.2.1										
	Display switching	Decimal and hexadecimal display of word device values Device comment display	Section 6.2.3			×		○	△ <sup>+1</sup>	○	△ <sup>+2</sup>		
	Device changing	Changing of device values	Section 6.2.4								△ <sup>+2</sup>		
	Print out	Printing of ladder	Section 6.2.5			×			○		△ <sup>+2</sup>		
System monitor function	Entry monitor	Monitoring of current values by pre-registering monitor devices	Section 9.2										
	Batch monitor	Monitoring of n points of current values subsequent to specified device	Section 9.3		○		×	△ <sup>+3</sup>		○	△ <sup>+3</sup>		
	T/C monitor	Monitoring of m points of current values, set values, contact points, and coils subsequent to specified device	Section 9.4		○		×	△ <sup>+2+4</sup>		○	△ <sup>+2</sup>		
	BM monitor	Monitoring of x points of current values subsequent to specified buffer memory of specified special module	Section 9.5		○		×	△ <sup>+2</sup>		○	△ <sup>+2</sup>		
	Data editing using test operation	Setting/resetting of bit device		Section 9.6		○		×	△ <sup>+2</sup>		○	△ <sup>+2</sup>	
		Changing of current value for buffer memory of word device			○		△ <sup>+5</sup>	×	△ <sup>+2</sup>	○	△ <sup>+5</sup>	○	△ <sup>+2</sup>
		Changing of current value for T/C (can be used while monitoring T/C)			○			×	△ <sup>+2</sup>		○		△ <sup>+2</sup>
		Changing of set value for T/C (can be used while monitoring T/C)			○		×	△ <sup>+2+6</sup>	○	×	○	△ <sup>+2</sup>	
Quick test	Changing of device values using quick test	Section 9.6.2		○		×	○		○	○			
Display switching	Device comment display		Section 9.1.2		○		×	△ <sup>+2+6</sup>		○	△ <sup>+2</sup>		
	Decimal and hexadecimal display of word device values and buffer memory values			○		×	○		○		○		
Special module monitor function	Monitoring of buffer memory of special module on special screen	Ch. 11				×				○	△ <sup>+2</sup>		
Network monitor function	Monitoring of network status of MELSECNET/B, (II) or /10	Ch. 15				×				○	△ <sup>+2</sup>		
List editor function	Sequence program in the ACPU is list edited.	Ch. 19				×				○	△ <sup>+2</sup>		

\*1 Subprograms 2 and 3 are not possible.

\*2 Can be monitored only when the A8GT-J61BT13 is used (in the intelligent device station).

\*3 When the A8GT-J61BT15 is used (in the remote device station), only the link devices assigned to the GOT can be monitored.

\*4 The T/C set values cannot be monitored if the software version of the A8GT-J61BT13 used is version W or earlier.

\*5 Can't change V or Z current values.

\*6 Cannot be monitored if the software version of the A8GT-J61BT13 used is version W or earlier.

(b) Connection with QnACPU or ACPU

Functions			Ref. Section	QnACPU					ACPU						
				Bus connection	CPU direct connection	Computer link connection	MELSEC NET connection	CC-Link connection	Bus connection	CPU direct connection	Computer link connection	MELSEC NET connection	CC-Link connection		
Utility function	Brightness/contrast adjustment	Adjusting the brightness/contrast of a monitor screen	Section 4.3												
	Message display selection	Selecting a message display.	Section 4.3												
	Screen & OS copy	Copying the screen and OS data between the internal memory and memory card.	Section 4.4												
	Setup	Setting a use environment of the GOT	Section 4.5			○					○				
	Self-test	Running diagnostic checks on GOT hardware	Section 4.6												
	Memory information	Displaying GOT memory information.	Section 4.7												
	Clock	Setting the clock.	Section 4.8												
	Screen cleanup	Displaying the display area cleanup screen.	Section 4.9												
	Password	Defining a password for limited access to the utility menu screen.	Section 4.10												
Ladder monitor function	Ladder monitor	Sequence program monitoring using ladder signals	Section 6.2.1												
	Display switching	Decimal and hexadecimal display of word device values	Section 6.2.3		○		×	△ <sup>+2</sup>		○	△ <sup>+1</sup>	○		△ <sup>+2</sup>	
		Device comment display													
	Device changing	Changing of device values	Section 6.2.4		○		×	△ <sup>+2</sup>						△ <sup>+2</sup>	
Print out	Printing of ladder	Section 6.2.5							○				△ <sup>+2</sup>		
System monitor function	Entry monitor	Monitoring of current values by pre-registering monitor devices	Section 9.2												
	Batch monitor	Monitoring of n points of current values subsequent to specified device	Section 9.3		○		×	△ <sup>+3</sup>			○			△ <sup>+3</sup>	
	T/C monitor	Monitoring of m points of current values, set values, contact points, and coils subsequent to specified device	Section 9.4												
	BM monitor	Monitoring of x points of current values subsequent to specified buffer memory of specified special module	Section 9.5		○		×	△ <sup>+2</sup>			○			△ <sup>+2</sup>	
	Data editing using test operation	Setting/resetting of bit device													
		Changing of current value for buffer memory of word device			○		△ <sup>+5</sup>	×	△ <sup>+2</sup>		○	△ <sup>+5</sup>	○		△ <sup>+2</sup>
		Changing of current value for T/C (can be used while monitoring T/C)			○			×	△ <sup>+2</sup>			○			△ <sup>+2</sup>
	Quick test	Changing of set value for T/C (can be used while monitoring T/C)			△ <sup>+6</sup>			×	△ <sup>+1+6</sup>		○	×	○		△ <sup>+2</sup>
		Changing of device values using quick test	Section 9.6.2						○						○
Display switching	Device comment display							△ <sup>+2</sup>						△ <sup>+2</sup>	
	Decimal and hexadecimal display of word device values and buffer memory values	Section 9.1.2		○		×		○		○				○	
Special module monitor function	Monitoring of buffer memory of special module on special screen	Ch. 11		○		×	△ <sup>+2</sup>			○				△ <sup>+2</sup>	
Network monitor function	Monitoring of network status of MELSECNET/B, (II) or /10	Ch. 15		○		×	△ <sup>+2</sup>			○				△ <sup>+2</sup>	
List editor function	Sequence program in the ACPU is list edited.	Ch. 19				×			○	×	○			△ <sup>+2</sup>	

- \*1 Subprograms 2 and 3 are not possible.
- \*2 Can be monitored only when the A8GT-J61BT13 is used (in the intelligent device station).
- \*3 When the A8GT-J61BT15 is used (in the remote device station), only the link devices assigned to the GOT can be monitored.
- \*4 Can't monitor T/C set values.
- \*5 Can't change V or Z current values.
- \*6 If you modified the set value for T/C using the ladder monitor test function, you need to repeat the PC readout procedure to enable the display of the modification.

(c) Connection with FXCPU, third party PLC or microcomputer

Functions		Ref. Section	FXCPU	Other PLC connection	Microcomputer connection		
			CPU direct connection				
Utility function	Brightness/contrast adjustment	Adjusting the brightness/contrast of a monitor screen	Section 4.3				
	Message display selection	Selecting a message display.	Section 4.3				
	Screen & OS copy	Copying the screen and OS data between the internal memory and memory card.	Section 4.4	○	○	○	
	Setup	Setting a use environment of the GOT	Section 4.5				
	Self-test	Running diagnostic checks on GOT hardware	Section 4.6				
	Memory information	Displaying GOT memory information.	Section 4.7				
	Clock	Setting the clock.	Section 4.8	△ <sup>*1</sup>	△ <sup>*2</sup>	△ <sup>*3</sup>	
	Screen cleanup	Displaying the display area cleanup screen.	Section 4.9	○	○	○	
	Password	Defining a password for limited access to the utility menu screen.	Section 4.10				
Ladder monitor function	Ladder monitor	Sequence program monitoring using ladder signals	Section 6.2.1				
	Display switching	Decimal and hexadecimal display of word device values	Section 6.2.3	○	×	×	
		Device comment display					
	Device changing	Changing of device values	Section 6.2.4				
Print out	Printing of ladder	Section 6.2.5					
System monitor function	Entry monitor	Monitoring of current values by pre-registering monitor devices	Section 9.2	○	×	×	
	Batch monitor	Monitoring of n points of current values subsequent to specified device	Section 9.3				
	T/C monitor	Monitoring of m points of current values, set values, contact points, and coils subsequent to specified device	Section 9.4	△ <sup>*4</sup>	×	×	
	BM monitor	Monitoring of x points of current values subsequent to specified buffer memory of specified special module	Section 9.5	×	×	×	
	Data editing using test operation	Setting/resetting of bit device		Section 9.6	○	×	×
		Changing of current value for buffer memory of word device					
		Changing of current value for T/C (can be used while monitoring T/C)					
	Quick test	Changing of set value for T/C (can be used while monitoring T/C)			×	×	×
Changing of device values using quick test		Section 9.6.2	○	×	×	×	
Display switching	Device comment display			×	×	×	
	Decimal and hexadecimal display of word device values and buffer memory values	Section 9.1.2	○	×	×	×	
Special module monitor function	Monitoring of buffer memory of special module on special screen	Ch. 11	×	×	×		
Network monitor function	Monitoring of network status of MELSECNET/B, (II) or /10	Ch. 15	×	×	×		
List editor function	Sequence program in the ACPU is list edited.	Ch. 19	×	×	×		

\*1 When connected to the PLC CPU without clock function (FX0, FX0N, FX1, FX2NC, FX0S), additional function cannot be set. Also, the clock function can be used with the FX2 and FX2N, when cassette for the realtime clock is used.

\*2 When connected to the PLC CPU without clock function, additional function cannot be set.

\*3 You can set the clock function only when you are using A9GT-RS2T, which includes a clock element.

\*4 T/C set values and coils cannot be monitored.

(3) If a system program (OS) for the expanded or option functions has been installed, the following space is required in the GOT built-in internal memory to store user-created monitor screen data. Hence, add the memory board as required.

The installation of an operating system is required for the following expanded or option functions:

- System monitor
- MELSEC-ACPU ladder monitor \*<sup>1</sup>
- MELSEC-FXCPU ladder monitor \*<sup>1</sup>
- MELSEC-QnACPU ladder monitor \*<sup>1</sup> \*<sup>2</sup>
- Special unit monitor, recipe, sound
- Network monitor
- List editor\*<sup>2</sup>
- ESC printer, bar code, report, external key input \*<sup>3</sup>
- PCL printer, bar code, report, external key input \*<sup>3</sup>
- ESC printer, bar code, report, proximity I/O \*<sup>3</sup>
- PCL printer, bar code, report, proximity I/O \*<sup>3</sup>

\*1 Any one of the 3 types can be installed.

\*2 The memory capacity is different from other OS. It is considered as the installation of 2 operating systems.

\*3 Any one of the 4 types can be installed.

Number of Extended functions OSs	Memory Space Used [k bytes]	Free Space [k bytes]
0	0	1152
1	256	896
2	384	768
3	640	512
4	768	384
5	1024	128
6	1152	0

**POINT**

If the special module monitor function is being used, enough memory space must be reserved in the internal memory to store the special module monitoring data (see Section 3.3.3).



1.3 Features

The monitor functions described in this manual are intended to improve the efficiency of trouble-shooting and maintenance operations for the PLC system.

The features of each monitor function are explained in the following sections.

1.3.1 Features of the utility function

The utility function enables you to use GOT setup and self-tests. To use the utility function, you need to install an operating system for the utility function on the GOT built-in internal memory by using drawing software. The features of the utility function are shown below.

(1) The brightness of a monitor screen can be adjusted (see Section 4.3 for details).

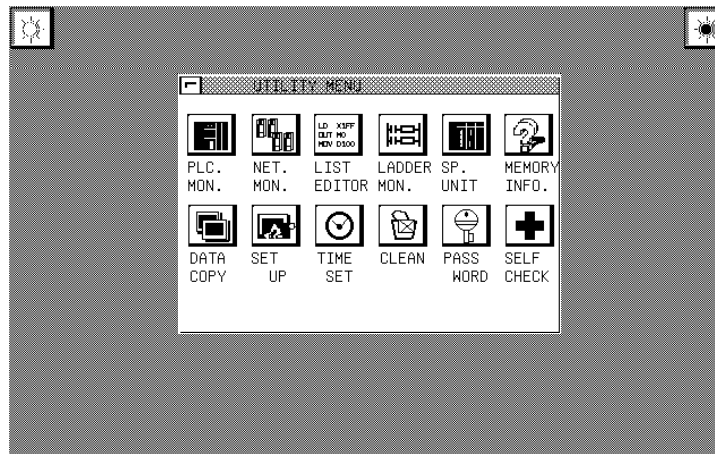

(2) The screen and OS data can be copied between the internal memory and memory card (see Section 4.4 for details).

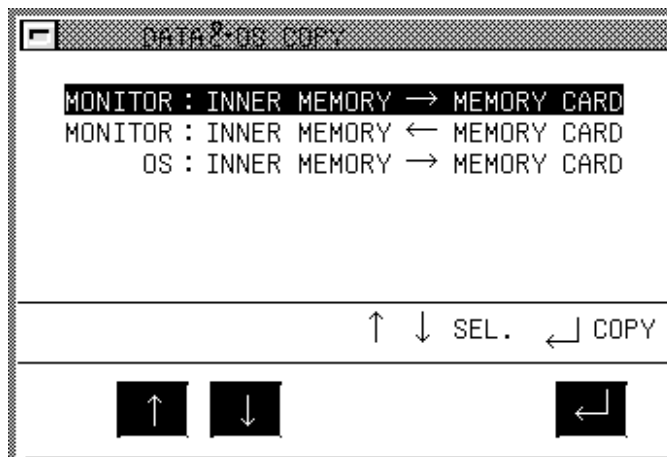

The data monitored can be copied to and from the GOT built-in internal memory or a memory card installed on the GOT.

The OS data can only be copied from the GOT to the memory card.

(3) Setting a use environment of the GOT (see Section 4.5 for details).

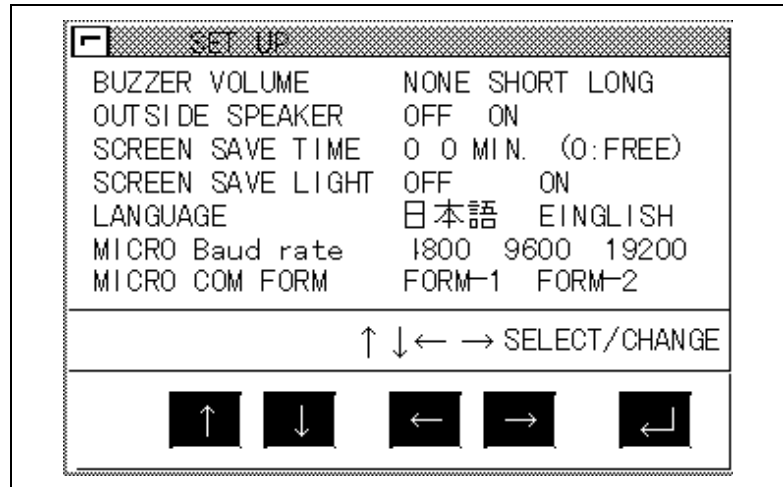

You can set the operating environment of the GOT such as the beep sound, message display language and screen saver's idle time. When using the A985GOT, you can also make settings on the Human sensor.

(4) Running diagnostic checks on GOT hardware (see Section 4.6).

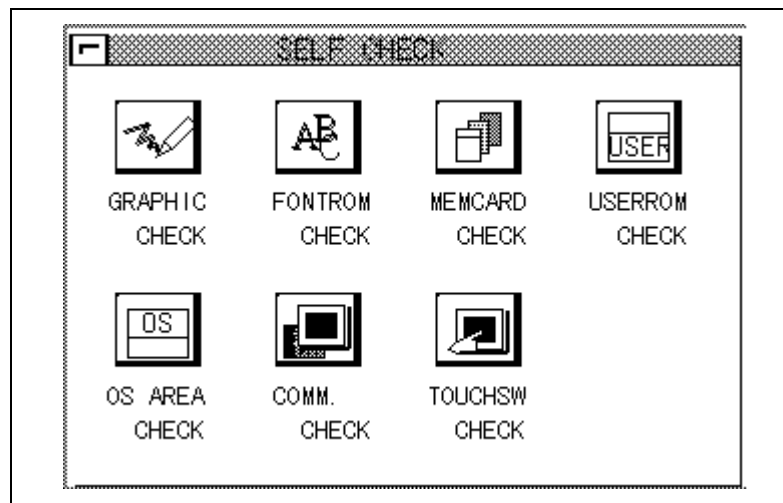

You can run diagnostic checks on the GOT hardware, including the image check, font check, memory card check and so on.

(5) Other functions (see Section 4.7 for details)

- Displaying data on available space in the GOT internal memory.
- Adjusting the clock of the PLC CPU.
- Displaying the display area cleanup screen.
- Changing security levels.
- Limiting access to the Utility Menu screen.

1.3.2 Features of the ladder monitor function

Installing the ladder monitor function operating system into the GOT built-in memory using the drawing software enables ladder monitoring of the PLC CPU program as shown in a ladder diagram. The features of the ladder monitor function are shown below.

(1) Monitoring based on ladder symbols (see Section 6.2 for details)

(Sample display) Ladder monitor screen

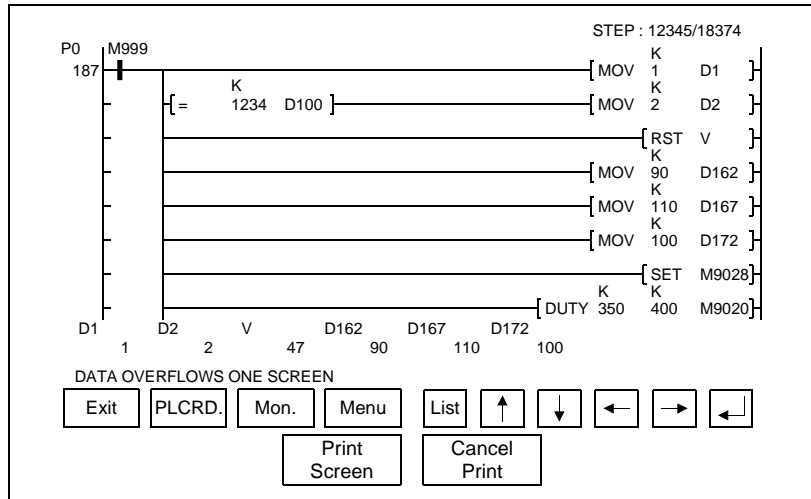

REMARK

The **Print Screen** and **Cancel Print** buttons are not displayed on the EL type screen.

(1) Ladder monitor screen

A maximum of 8 lines (max. 11 contact points per line; with 12 contact points or more, the line returns) of a sequence program are displayed on one screen.

Also, for the current values and other settings of word devices, a maximum of 8 devices are displayed (With 9 devices or more, use the arrow keys to switch displays.).

- (2) The display format can be changed to show comments for devices (see Section 6.2.2 for details).

(Sample display) Ladder monitor screen

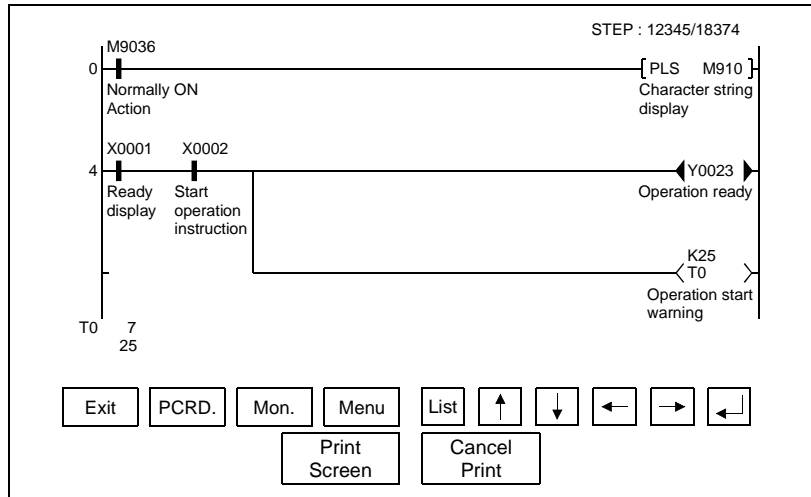

- 1) Switching the display format
  - The current values monitor of the word devices at the bottom of the screen are executed in decimal or hexadecimal format.
- 2) Displaying device comments
  - Comments of for the device used in the PLC program (comments that are written into the PLC CPU) are displayed.
  - When comments are displayed, 3 lines of the program are shown.
- (3) Monitoring other stations
  - Other stations in data link systems, network system or CC-Link system, including the GOT (or stations connected to the GOT), can be monitored.

1.3.3 Features of the system monitor function

Installing the screen monitor function operating system into the GOT built-in memory using the drawing software enables monitoring and testing of the buffer memory for the PLC CPU program and the special functions module. The features of the system monitor function are shown below.

(1) Any desired device can be monitored, using 4 dedicated screens

The system monitor function provides an entry monitor, a batch monitor, and a buffer memory monitor, enabling monitoring of any device, for complete flexibility in any application.

Entry monitor

DEVICE MONITOR				TEST	MENU	FORM	SET
NETWK No. [ 0 ]		STATION[FF]					
D	15	-2147483648	DW				
D	10	-32767					
X	001	●					
M	25	○					
Y	70	●					
W	200	43					
R	50	68378428	DW				
D	300	30000					

- Up to 8 points for a PLC CPU device registered by the user can be monitored in one window (see Section 9.2).

Batch monitor

BATCH MONITOR				TEST	MENU	FORM	SET
NETWK No. [ 0 ]		STATION[FF]					
D	10	32767	D	18	-500		
D	11	0	D	19	3234		
D	12	0	D	20	0		
D	13	-1	D	21	0		
D	14	0	D	22	0		
D	15	3	D	23	-32768		
D	16	0	D	24	0		
D	17	0	D	25	0		

- Up to 16 points subsequent to a PLC CPU device specified by the user can be monitored in one window (see Section 9.3).

T/C monitor

TC MONITOR				TEST	MENU	FORM	SET
NETWK No. [ 0 ]		STATION[FF]					
T	0 PV	0 SV	0	↑	○	△	
[Production line A ]							
T	1 PV	0 SV	0	↑	○		
[Production line B ]							
T	2 PV	150 SV	150	■	●		
[Production line C ]							
T	3 PV	0 SV	0	↑	○	▽	
[Production line D ]							

- Up to 8 points, including the current value, set value, contact point, and coil can be monitored in a window subsequent to a PLC CPU timer (T)/counter (C) specified by the user (see Section 9.4).

Buffer memory monitor

BM MONITOR				TEST	MENU	FORM	SET
NETWK No. [ 0 ]		STATION[FF]					
I/O NO[ 1 ]							
BM	1110	-32767	BM	1118	0		
BM	1111	64	BM	1119	0		
BM	1112	149	BM	1120	150		
BM	1113	-1111	BM	1121	131		
BM	1114	126	BM	1122	-32768		
BM	1115	160	BM	1123	555		
BM	1116	255	BM	1124	2368		
BM	1117	1200	BM	1125	11000		

- Up to 16 points subsequent to the buffer memory of a special function module specified by the user can be monitored in one window (see Section 9.5).

- With the GOT, the full screen can be divided into four windows and separate monitoring carried out in all four windows simultaneously.

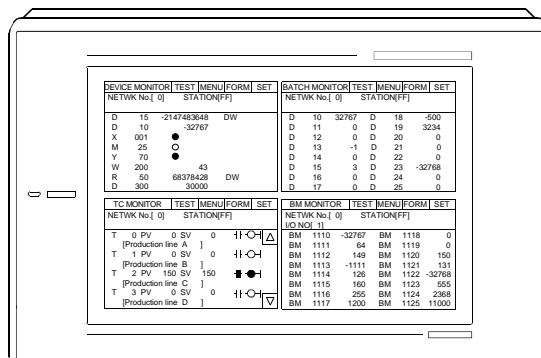

(2) Data can be changed by test operation (see Section 9.6 for details).

(Test sample)

When M0 is on

When changing D0 present value

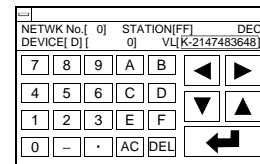
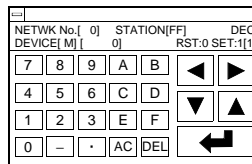

1) Test for bit device

Device specified by user is turned on or off.

2) Test for word device

Writes designated value into device specified by user.

3) Test for timer/counter

Writes in designated value as current value or set values of device specified by user.

4) Test for buffer memory

Writes designated value into buffer memory specified by user.

(3) Display format can be changed and device comments can be displayed (see Section 9.1.2 for details).

(Sample display)

For entry monitor  
(comment display)

For batch monitor  
(hexadecimal display)

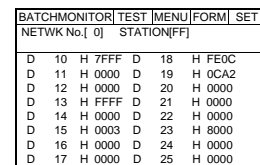
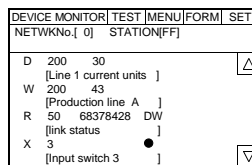

1) Changing display format

The word device values for the entry monitor, batch monitor, T/C monitor, and the buffer memory monitor are monitored in decimal or hexadecimal format.

2) Device comment display

When the PLC CPU device is monitored, the comments written into the PLC CPU are displayed.

(4) Other stations can be monitored.

Other stations in data link systems, network systems or CC-Link systems, including the GOT (or stations connected to the GOT), can be monitored.

1.3.4 Features of the special module monitor function

Installing (or downloading) the special module monitor function operating system and special module monitor data into the GOT built-in memory using the drawing software enables monitoring and changing of data in the special function module buffer memory, using dedicated screens.

Signal statuses of I/O modules can also be monitored.

The features of the special module monitor function are shown below.

- (1) Monitoring can be done with dedicated screens (see Section 12.2 for details). Monitoring is carried out using dedicated screens provided by the manufacturer for the special function module and I/O module. It is not necessary for the user to create monitor screens.

(Sample display 1: for special function module)

Menu screen after module selection

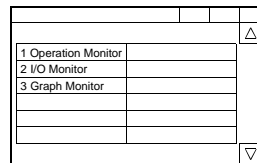

Monitor screen after menu selection

Menu selection

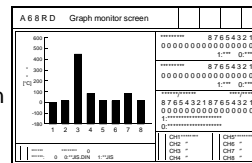

(Sample display 2: for I/O module)

Monitor screen

X MODULE		X	X
Q40	•	Q50	•
Q41	•	Q51	•
Q42	•	Q52	•
Q43	•	Q53	•
Q44	•	Q54	•
Q45	•	Q55	•
Q46	•	Q56	•
Q47	•	Q57	•
Q48	•	Q58	•
Q49	•	Q59	•
Q50	•	Q60	•
Q51	•	Q61	•
Q52	•	Q62	•
Q53	•	Q63	•
Q54	•	Q64	•
Q55	•	Q65	•
Q56	•	Q66	•
Q57	•	Q67	•
Q58	•	Q68	•
Q59	•	Q69	•
Q60	•	Q70	•

1) Menu screen

The menu is displayed classified into monitor items for the special function module only.

The object monitor screen is displayed by selecting the item from the menu.

2) Monitor screen

With the special function module, the buffer memory contents and the status of the PLC CPU I/O signals are monitored using text, numbers, and graphs. With the I/O module, the status of I/O signals to and from an external module is monitored.

(2) Data can be changed by writing (see Section 12.1.5. for details).

(Writing example)  
Monitor screen

When changing channel that can be changed

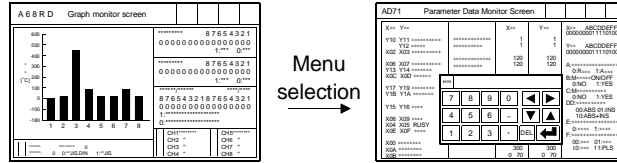

- 1) The designated values are written into the user-specified buffer memory by writing the values from the monitor.
  - 2) When changing the buffer memory data, input the numeric value using the auto display key window and write it into the buffer memory.
- (3) Special module monitor data can be allocated as user monitor screen data. The special module monitor data installed in the computer can be allocated to serve as user monitor screen data. To do this, the steps below are required.
- 1) Using the Copy function, allocate special module monitor data from another project as user monitor screen data.
  - 2) Correct the data to match the system used for the BM initial buffer memory number of the sprite function which has been set.



1.3.5 Features of the network monitor function

To use the network monitor function, you first must install an operating system (OS) for the network monitor function on your GOT by using drawing software. This enables you to monitor the status of the MELSECNET/B, MELSECNET (II), and MELSECNET/10 networks. The following describes the features of the network monitor function.

- (1) Network monitor screens are selectable on the own station monitor screen to monitor the own station and other stations on a network.

The own station monitor screen enables you to monitor the status of all the network lines connected to the own station.

A touch of the screen will guide you through various monitor screens to monitor the status of the own station and other stations on a network.

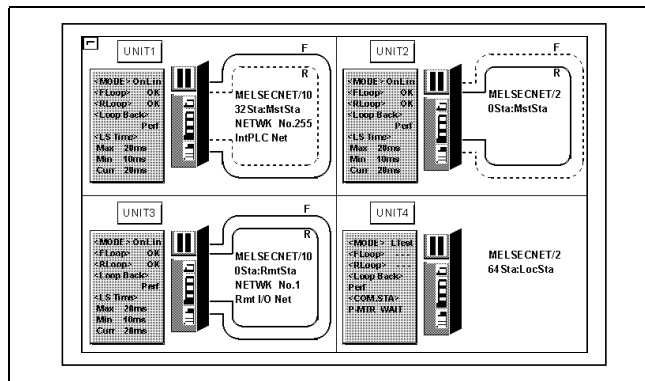

- (2) Network information can be obtained from the own station monitor screen. Dedicated monitor screens are available for each category of station classification, depending on the role that is played by the own station.

Network category: MELSECNET/B, MELSECNET (II) master station  
 MELSECNET/B, MELSECNET (II) local station  
 MELSECNET/10 control station/ordinary station  
 MELSECNET/10 remote master station

(Sample display) MELSECNET/B, MELSECNET (II) master station

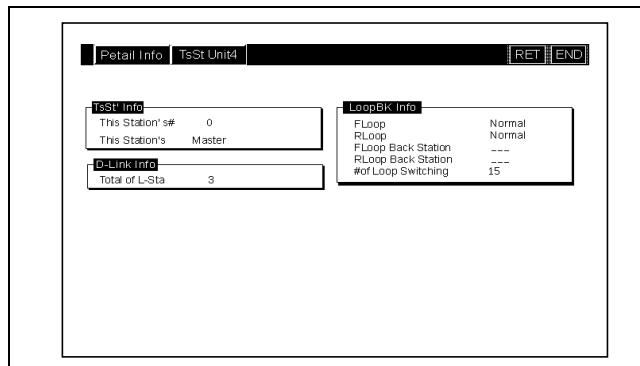

(3) The status of other stations can be monitored on the other-station monitor screen.

The other-station monitor screen provides the following type of information on the status of other stations connected on a network:

- Communications status of each station
- Data link status of each station
- Parameters status of each station
- CPU action status of each station
- CPU RUN status of each station
- Loop status of each station

(Sample display) Other station monitor menu screen

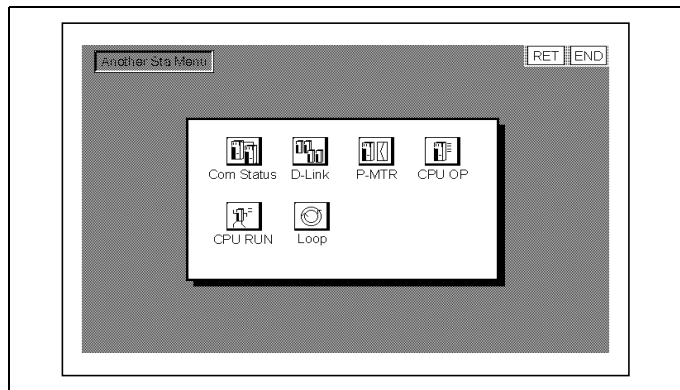

Other station's communications status monitor screen

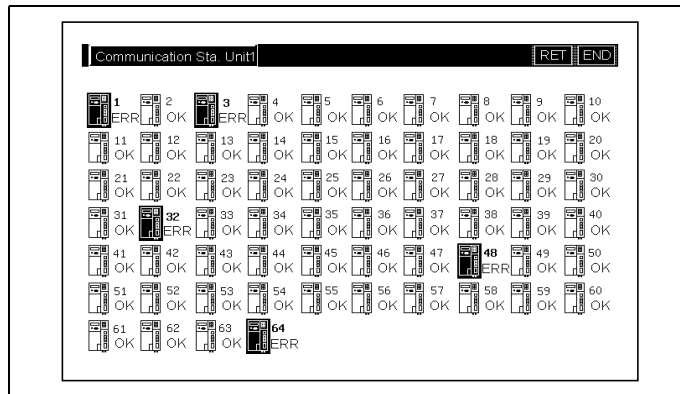

1.3.6 Features of the List editor function

Installation of the List editor function OS into the memory with the drawing software allows for list edit of the sequence program in the ACPU. The following shows features of the List editor function.

(1) Easy parameters and sequence program maintenance

Simple key operations allow checks, partial modifications, changes and additions of the parameters and the sequence program in the PLC CPU. Without peripheral equipment other than the GOT, the sequence program can be simply edited.

Example of command change in the sequence program

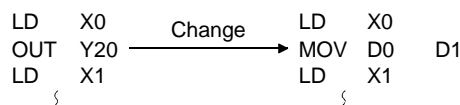

(2) Interlock with the ladder monitor function (only when A985/97\*/960GOT is used)

The list edit window can be started from the ladder monitor screen with a single touch. The list can be edited while viewing the ladder. The list can also be displayed from the step line displayed on the ladder monitor.

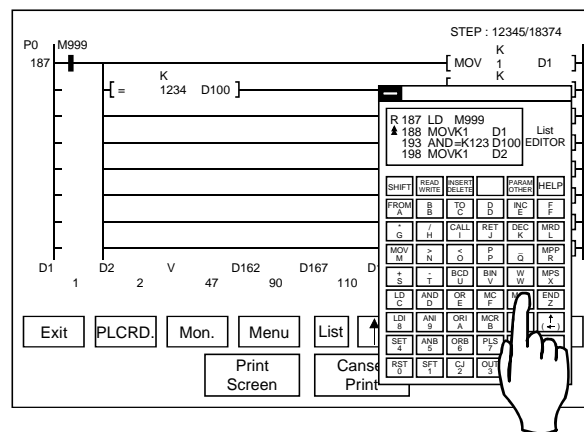

(3) The list edit screen can be recorded.

The hard copy function allows recording the edit screen of the list program.

(4) Access to other station is available.

The sequence program of the PLC CPU in other station can be list edited.

(5) Useful help functions

Help functions for read, write, insert and delete are available on the interactive menu selection system. Simple operation is facilitated.

(6) Comment for each device can be displayed.

Comment of the device at the cursor position can be displayed.

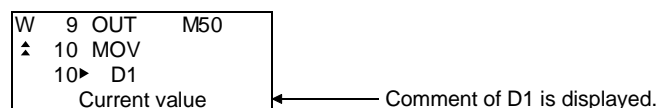

Chapter2 Before beginning operation

The required equipment for using the monitor functions in this manual are described in this section.

2.1 Required equipment

The chart below shows the equipment required for using the monitor functions.

○: Required ×: Not required

Required equipment	Application	Utility	Ladder monitor	System monitor	Special function module monitor	Network monitor	List editor
GOT main unit (A95*GOT-*BD-M3)	<ul style="list-style-type: none"> <li>It is required to use the option function installed on the A95*GOT.</li> </ul>	×	×	×	×	○	○
Memory board *1	<ul style="list-style-type: none"> <li>It is required to use the option function installed on the A985/97*/960GOT.</li> </ul>		○		○		
PLC drawing software *2	<ul style="list-style-type: none"> <li>Required for installing the object monitor function OS into the GOT and downloading the special module monitor data.</li> <li>It is necessary to install the drawing software into the PLC.</li> </ul>	○					
Connecting cables *2	<ul style="list-style-type: none"> <li>Required for connecting the above PLC and the GOT when installing the object monitor function OS into the GOT and downloading the special module monitor data.</li> </ul>	○					

\*1 The table below shows the types of memory boards available for using the option functions.

Name	Model	Contents
Memory board for option functions	A9GT-FNB	For option function (applicable for A/FX ladder monitor)
	A9GT-QFNB	For option function (applicable for QnA/A/FX ladder monitor)
Expanded memory board for option functions	A9GT-FNB1M	Option function (applicable for A/FX ladder monitor) + internal memory extension 1MB
	A9GT-FNB2M	Option function (applicable for A/FX ladder monitor) + internal memory extension 2MB
	A9GT-FNB4M	Option function (applicable for A/FX ladder monitor) + internal memory extension 4MB
	A9GT-FNB8M	Option function (applicable for A/FX ladder monitor) + internal memory extension 8MB
	A9GT-QFNB4M	Option function (applicable for QnA/A/FX ladder monitor) + internal memory extension 4MB
	A9GT-QFNB8M	Option function (applicable for QnA/A/FX ladder monitor) + internal memory extension 8MB

\*2 For information about the PLC on which to install and use drawing software and the cable to be connected between the PLC and the GOT, see SW4D5C-GOTR-PACKE(V) Operating Manual.



Chapter3 Specifications

In this chapter, the specifications of the ladder monitor function, system monitor function, special module monitor function, and list editor function are discussed separately.

3.1 Ladder monitor function specifications

POINTS	<ul style="list-style-type: none"> <li>• When the ladder monitor function is used on the A985/97*/960GOT, the memory board applicable for the PLC CPU at the monitoring destination.</li> <li>• The ladder monitor function cannot be used on the A95*GOT.</li> </ul>
--------	---

3.1.1 PLC CPUs to be monitored

The PLC CPUs that allow ladder monitoring are the QCPU (A Mode), QnACPU, ACPUCPU, FXCPU and motion controller CPU. For details, refer to Section 1.2 (2).

POINT	Ladder monitoring is not available for sub-programs 2 and 3 of A4UCPU (when connected to the computer link).
-------	--

3.1.2 Access ranges to be monitored

For access range for the ladder monitor function, see GOT-A900 Series User's manual (SW4D5C-GOTR-PACKE compatible Connection system manual).

POINT	<ul style="list-style-type: none"> <li>• When the capacity of parameter, PLC program, TC setting value, comment and extension comment is 144 kbytes or more, the comment will not be properly displayed.</li> <li>• The local device cannot be monitored on the QnACPU.</li> </ul>
-------	--

3.2 System monitor function specifications

3.2.1 PLC CPUs to be monitored

The PLC CPUs that allow system monitoring are the QCPU, QnACPU, ACPUC, FXCPU and motion controller CPU. For details, refer to Section 1.2 (2).

3.2.2 Access ranges to be monitored

For access range for the system monitor function, see GOT-A900 Series User's manual (SW4D5C-GOTR-PACKE compatible Connection system manual).

3.2.3 Names of devices to be monitored

For the names of devices that can be monitored with the system monitor function, see GOT-A900 Series User's manual (SW4D5C-GOTR-PACKE compatible Connection system manual).

3.2.4 Precautions when using the system monitor function

The precautions to follow when using the system monitor function are shown below.

(1) Monitor and test of real number data

Real number data cannot be monitored or tested.

Monitoring of word devices that save real number data is all done by integer data (binary data).

(2) Monitoring in 32-bit modules

When monitoring word devices (such as T, C, D, W) in 32-bit (2-word) modules, monitor up to the point where 32 bits remain in the monitor processing. A location where 16 bits (1 word) remain cannot be monitored.

This situation occurs when an odd number has been specified as the initial number in the monitor device.

(Example) When monitoring the A2NCPUC data register in 32-bit modules beginning with an odd number (D1, D3...)

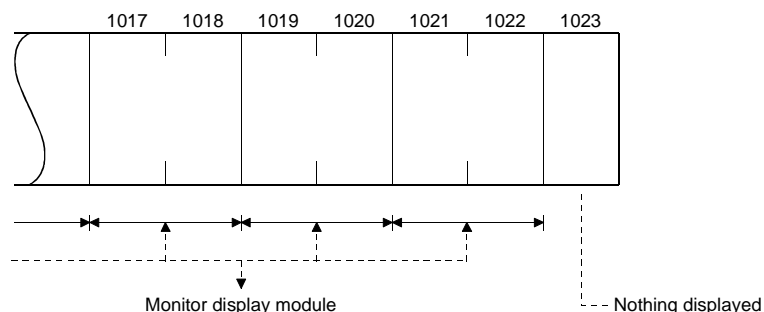

- (3) The "Date" column of a Rated Plate shows the date manufactured and function version number. If it reads "9707 B" or a later notation, timer/counter settings can be changed and device comments can be displayed when using any of the large-scale QnACPU's or small-scale QnACPU's.
- When changing the timer/counter setup value and performing the device comment display, use the CPU that is described above.

<Viewing the Rated Plate>

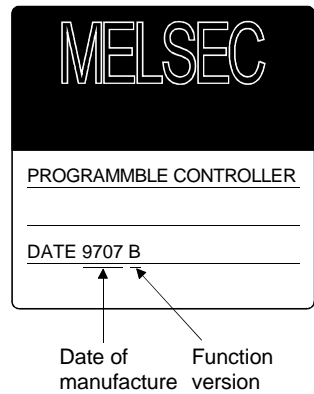



## 3.3 Special module monitor function specifications

POINTS
<ul style="list-style-type: none"><li>• The memory board is required to use the special unit monitor function on the A985/97*/960GOT.</li><li>• The special unit monitor function cannot be used on the A95*GOT.</li></ul>

## 3.3.1 Access ranges to be monitored

- (1) When using bus connection/CPU direct connection/computer link connection
  - The special function modules on the bases of the connected station and other stations can be monitored.
- (2) When using MELSECNET(II) connection/MELSECNET/B connection
  - The special function module on the base of the master station can be monitored. (Cannot be monitored when the master station is the QnACPU.)
  - The special function modules on the bases of local stations cannot be monitored.
- (3) When using MELSECNET/10 connection
  - The special function modules on the bases of the control station and normal stations can be monitored. (Cannot be monitored when the stations are the QnACPU.)
- (4) When using CC-Link connection (remote device station)
  - The special function modules cannot be monitored.
- (5) When using CC-Link connection (intelligent device station)
  - The special function modules on the bases of the master and local stations can be monitored.
- (6) When using the system configuration where remote I/O stations exist
  - The special function modules cannot be monitored in any connection form.

## 3.3.2 Special function modules to be monitored

The modules for which special function monitoring can be done are only those types shown in Section 3.3.3.

Monitoring of special function modules other than those can be done with the system monitor function "BM Monitor".

### 3. SPECIFICATIONS

#### 3.3.3 Memory capacity required for using the special module monitor function

The memory capacity required when saving special module monitor data to the GOT built-in memory and the memory capacity required when saving to a Personal computer hard disk are shown below.

(Unit: kilobytes)

Software to be saved	Memory capacity required when saving to GOT built-in memory	Memory capacity required when saving to a personal computer hard disk	Remarks
Special module monitor data	13.4		
A61LS	14.5		
AD61	8.14		
A62DA-S1	6.91		
A62LS	69.8		
A68AD(S2)	9.97		
A68ADN	15.0		
A68RD3 A68RD4	17.8		
A616AD	123		
A616DAI A616DAV	33.5		By merely downloading either, both sides can be monitored.
A616TD	230		
AD70	20.5		
AD70D	29.3		
AD71(S1/S2/S7)	546		
AD72 A1SD71-S2(S7)	562		
AD75P1(P2/P3)*1 A1SD75P1(P2/P3)*2	520		
AJ71PT32-S3	43.5		
AJ71ID1(ID2)-R4 A1SJ71ID1(ID2)-R4	40.5		
A84AD	20.2		
A1SD61	36.9		
A1S62DA	5.12		
A1S62RD	12.5		
A1S63ADA	16.4		
A1S64AD	12.3		
A1S68AD	9.75		
A1S68DAI A1S68DAV	25.8		By merely downloading either, both sides can be monitored.
A1SD70	21.1		
A1SJ71JPT32-S3	43.2		
A1S64TCTT/RT-S1	45.7		
Input module	0.0		
Output module	0.0		

\*1 The AD75M1(M2/M3) can be monitored within the monitoring range of the AD75P1(P2/P3).

\*2 The A1SD75M1(M2/M3) can be monitored within the monitoring range of the A1SD75P1(P2/P3).

## 3.3.4 Precautions when using the special module monitor function

The precautions to follow when using the special module monitor function are discussed below.

## (1) Special function modules that cannot be monitored

Modules displayed as "special" on the system configuration screen cannot be monitored using the special module monitor function.

To monitor these modules, use the system monitor function "BM Monitor".

## (2) Display when connecting the small building-block type PLC CPU

This precaution pertains to a situation where an expansion base unit for a large building block type of setup is connected to a small building-block type CPU (such as the A1SCPU) in a station connected to the GOT.

In such a case, the special function module on the large expansion base unit is displayed on the system configuration screen with the same model name as that of the small building-block type special function module.

If there is no small building-block type special function module, "special" is displayed and the object module cannot be monitored.

(Example)

[Module Model]	[Model Name Displayed]
AD72	▶ A1SD71
AJ71ID	▶ A1SJ71ID
AJ71PT32-S3	▶ A1SJ71PT32-S3
AD75P	▶ A1SD75P
A68AND	▶ A1S64AD
A68RD	▶ A1S62RD

## (3) Monitoring restricted special function modules

## (a) When monitoring the AD71 (S1, S2, S7)

When the slot on front of the AD71 module is an empty slot, monitoring is done in the following way.

1) The AD71 is treated as the AD72, and "AD72" is displayed on the system configuration screen.

In this case, when monitoring the AD71, select the AD72 in the object display position.

2) The monitor screen that is displayed by 1) above is for the AD72.

The number obtained by subtracting 10H from the I/O signal number on the display is the number to be used when installing the AD71 in the 0 slot.

\* If you do not want the AD1 to be treated as the AD72, execute "Shift the installation position of AD71 forward" or "In the I/O assignments, assign the empty slot in front of AD71 to the 16 X-Y points."

## (b) When monitoring the A68AD installed in the small building-block type PLC CPU

With the GOT, the A68AD that is installed in the expansion base unit for the building-block type setup connected to the small building-block type CPU (such as the A1SCPU) is recognized as the A1S68AD and monitored as such.

Since the buffer memory composition of the A68AD and the A1S68AD is not the same, different data is displayed on the screen when monitoring the A68AD (displayed as the A1S68AD).

\* An A68AD that is installed in the base unit of the building-block type PLC CPU (such as the AnUCPU) can be monitored normally.

(c) When monitoring the A1SD75M, AD75M

The A1SD75M/AD75M is displayed as A1SD75P/AD75P.

The A1SD75M/AD75M can be monitored within the monitoring range of the A1SD75P/AD75P.

(d) When monitoring the A81CPU

The A81CPU is monitored in the following way.

	64 points in first half	64 points in last half
Treatment of A81CPU	Change to module that cannot be monitored.	Change to input module.
System configuration screen	Display "Special X, Y [ ]"	Display "Input 64 X [ ]"
Possibility of monitoring	Not possible	Can be monitored as input.

(e) When monitoring an I/O composite module

1) With an I/O composite module for which "Output [ ]" is displayed on the system configuration screen, only the output signal can be monitored. For the input signal, monitor X of the PLC CPU device with the system monitor function.

(4) Editing and allocating of special module monitor data

Data displayed on a special module monitor screen cannot be edited by modifying or adding an object, except that the data can be used on a user-created monitor screen.

(5) Precaution for I/O allocation setting

(a) When the QnACPU is connected, the head XY numbers are displayed in due order on the special module monitoring system configuration screen if the I/O allocation setting is random as shown below.

When performing special module monitoring, always perform the I/O allocation in order from slot 0.

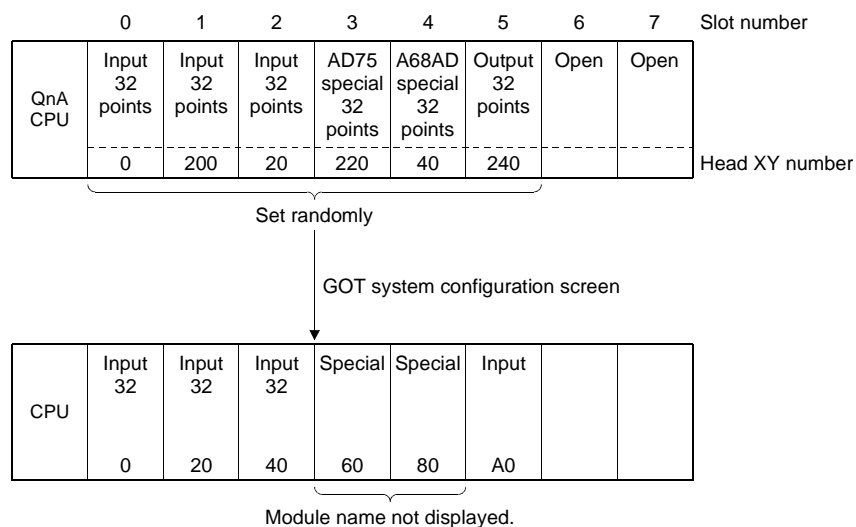

(b) If the slot assigned to Output in I/O allocation is not fitted with a module, the GOT displays Input. (Common to ACPUs and QnACPU)

(6) The system configuration including remote I/O stations cannot be monitored.

3.4 Network monitor function specifications

POINTS
<ul style="list-style-type: none"> <li>• The memory board is required to use the network monitor function on the A985/97*/960GOT.</li> <li>• The A95*GOT-*BD-M3 (memory extension type) is required to use the network monitor function on the A95*GOT.</li> <li>• When the connection target is the QCPU (Q mode), the network monitor function cannot be used.</li> <li>• The network status of the MELSECNET/10H cannot be monitored.</li> </ul>

3.4.1 Network information to be monitored

The following table shows the types of network information that can be monitored.

Table 3.1 Network Information To be Monitored

Function	Network Information	MELSECNET (II)/B Master Station	MELSECNET (II)/B Local Station	MELSECNET /10 Control Station	MELSECNET /10 Ordinary Station	MELSECNET /10 Remote Master Station	
Own station monitor	Network category display	○	○	○	○	○	
	Network No. display	×	×	○	○	○	
	Station No. display	○	○	○	○	○	
	Own station operation mode	○	○	○	○	○	
	Own station loop line status	○	○	○	○	○	
	Loop back execution status	○	○	○	○	○	
	Link scan time display	○	×	○	○	○	
	Data link system loop status	○	×	○	○	○	
Detailed own station monitor	Own station communications status	×	○*1	×	×	×	
	Own station's station No.	○	○	○	○	○	
	Own station information	Own station	○	○	×	×	×
		Network No.	×	×	○	○	○
		Group No.	×	×	○	○	×
		Specified control station	×	×	○	○	×
	Control-station information	Current control station	×	×	○	○	×
		Communications information	×	×	○	○	×
		Sub-control-station link	×	×	○	○	×
		Remote-I/O-master-station station No.	×	×	○	○	×
	Data link information	Total of linked stations	○	○	○	○	○
		Largest connected station	×	×	○	○	○
		Largest data-linked station	×	×	○	○	○
		Communications status	×	○	○	○	○
		Causes of interrupted communications	×	×	○	○	○
	Constant link scan	Constant link scan	×	×	○	○	○
		BWY receive	×	○	×	×	×
	BW receive	×	○	×	×	×	
	Loopback	F-loop status	○	○	○*2	○*2	○*2
		R-loop status	○	○	○*2	○*2	○*2
		F-loopback station	○	×	○*2	○*2	○*2
		R-loopback station	○	×	○*2	○*2	○*2
		Loop switching frequency	○	×	○*2	○*2	○*2
	Own station status	Parameter settings	×	×	○	○	×
Designation of reserved stations		×	×	○	○	○	
Communications mode		×	×	○	○	○	
Designation of transmission		×	×	○*2	○*2	○*2	
Transmission status		×	×	○*2	○*2	○*2	
Other station monitor	Communications status of each station	○	×	○	○	○	
	Data link status of each station	○	×	○	○	○	
	Parameter status of each station	○	×	○	○	○	
	CPU action status of each station	○	○	○	○	×	
	CPU RUN status of each station	○	○	○	○	×	
	Loop status of each station	○	×	○*2	○*2	○*2	

\*1 Accessible only when connected to a MELSECNET(II) local station.

\*2 Accessible only when connected to a MELSECNET/10 optical fiber cable.

○: Accessible ×: Not accessible

3.4.2 Access ranges to be monitored

For access range for monitoring, see Chapter 2 of the GOT-A900 Series User's manual (SW4D5C-GOTR-PACKE compatible Connection system manual).

3.4.3 Precautions when using the network monitor function

The following describes precautions that should be followed when using the network monitor function.

(1) When the GOT is connected to an AnNCPU or AnACPU, a screen display shows a screen of the MELSECNET II network even when you are connected to the MELSECNET/10 network (the monitor screen shows the display contents of the MELSECNET II).

(2) There may be a possibility that the network monitor function cannot be used, depending on which CPU to connect and which connection method to use.

CPU to Be Connected	Connection Method	Network Monitor Function		
		Own Station Monitor	Detailed Own Station Monitor	Other Station Monitor
QCPU, QnACPU, ACPU, Motion controller cpu	Bus connection	○	○	○
	Direct CPU connection			
	MELSECNET connection *1			
	Computer link connection *2			
	CC-Link connection			
FXCPU	CPU direct connection	×	×	×
Other manufacture's PLC				

\*1 When connected to a QnACPU, control and master stations cannot be monitored.

\*2 When connected to an AnUCPU, monitoring cannot be done with the MELSECNET/10 network card being installed.

(3) When connected to a QnACPU, monitoring cannot be done with the keyword being defined.

## 3.5 List editor function specifications

POINTS	
	<ul style="list-style-type: none"> <li>• To use the List editor function on the A985/97*/960GOT, the memory board is required.</li> <li>• To use the List editor function on the A95*GOT, the A95*GOT-*BD-M3 (memory extension type) is required.</li> </ul>

## 3.5.1 PLC CPU that allows for list edit

PLC CPUs that allow list edit are either the QCPU(A mode) or the ACPU.  
For details, refer to section 1.2 (2) (a).

POINT	
	<ul style="list-style-type: none"> <li>• With the computer link connection, the above PLC CPUs do not allow use of the List editor function.</li> <li>• In using the A2USH-S1/A2SH-S1/A2SH/A1SH/A1SJHCPU, the following restrictions should be observed in the range of list edit.            In using the A2USHCPU-S1 : In the range of the A3UCPU            In using the A2SH-S1/A2SH/A1SH/A1SJHCPU : In the range of the A3NCPU</li> </ul>

## 3.5.2 Access range that allows for list edit

For information about the access range that allows for list edit, see Chapter 2 of the GOT-A900 Series User's manual (SW4D5C-GOTR-PACKE compatible Connection system manual).

## 3.5.3 Precautions for List editor function

Precautions for the List editor function are as follows:

- (1) Precaution for reading with the specified command  
The command cannot be specified to read the ladder.
- (2) Precaution for use with the ladder monitor function  
If list edit is performed while the ladder monitor function is started, the edit details are not shown on the ladder monitor screen.  
To show the edit details, the ladder monitor must be read from the PLC again.
- (3) Precaution for list edit  
While the corresponding PLC is at stop status, perform list edit.  
The list cannot be edited during PLC running.
- (4) Precaution for parameter changing on the other peripheral device  
If parameter settings are changed on the other peripheral device during use of the list edit function, they will be different from the settings of the internal parameters of the list edit function.  
For this reason, reset the GOT unit or make PC No. setting again to read the parameters.

3.5.4 List of key arrangement and key functions

Key arrangement and key functions of the list edit window are shown below.

When the A985/97\*/960GOT is used

When the A95\*GOT is used

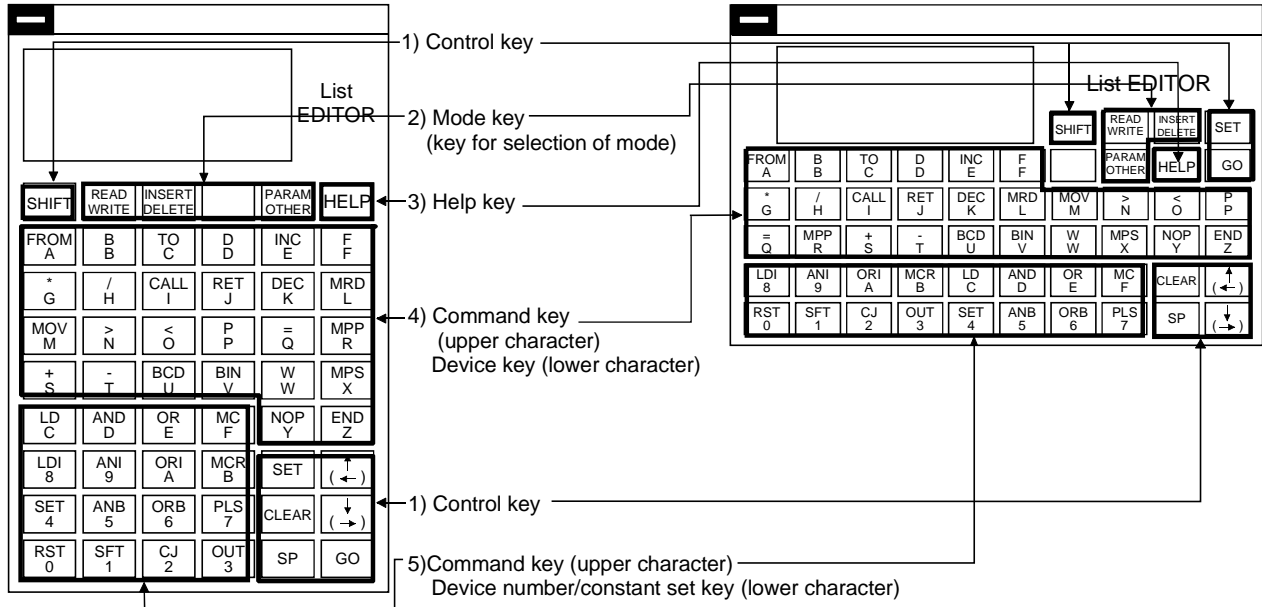



No.	Name	Key	General description of function
1)	Control key	SET	Key that declares start of step number input or automatic scroll. Switch key that makes the lower character valid on each key with dual functions. Whether upper or lower character is valid can be checked on the display.
		SHIFT	Switch key that makes the upper character valid on each key with dual functions. Whether upper or lower character is valid can be checked on the display.
		CLEAR	If the Clear key is pressed when the system is not in the Parameter mode, Other mode or Help function, the screen returns to the initial status of the mode selection. (The input commands or device numbers except for the mode are cleared.) This is used for repeating the procedure if incorrect keys are pressed.
			In the Parameter mode, the process is cancelled. After restarting, continue the operation.
			In the Other mode, the screen returns to the previous display.
		When the Help function is used, the screen returns to the display at the input of the <b>HELP</b> key.	
		SP	Key that provides blank space at the command and at between device names.
(←), (→)	Key that moves the cursor on the display (▶, ■) or determines scroll directions.*		
2)	Mode key	READ WRITE to PARAM OTHER	Key that selects each mode of the List editor function. Switch the upper/lower character mode with the <b>SHIFT</b> key.
		HELP	Key that selects the help function in the mode supporting the help function.
3)	Help key	HELP	Key that selects the help function in the mode supporting the help function.
4)	Command key Advice key	FROM A to END Z	Key that inputs K/H at the input of command, device name and constant input. Only when the valid key of upper/lower character needs to be switched, switching is allowed with input of the <b>SHIFT</b> and <b>SET</b> keys.
5)	Command key Device No./Constant setting key	RST 0 to MC F	Key that inputs the command, device number and constant. Only when the valid key of upper/lower character needs to be switched, switching is allowed with input of the <b>SHIFT</b> and <b>SET</b> keys.



\* Movement of the cursor key between steps, between the menu items and in the input area is explained below.

(1) Keep pressing the cursor key to repeat the movement toward the specified key direction.



(2) Movement between steps and between menu items

To display the program immediately before/after the current step number command, Input either  or  key.



: Program immediately before the command (no change after 0 step)



: Program immediately after the command (no change after the last step)

R	0	L D	X 0 0 0 5
	1	A N D	M 2
	2	 O U T	T 0
	3	K 1 2 3	

"" moves to the specified direction (upward/downward) with  or  key.



(3) Movement in the input area

To move the cursor between command names, between sources, and between destinations, input either  or  key.

W	1 1 5	M 5	
	1 2 0	L D	M 3
	1 2 1	 N 0 P	
P	K 2 1 4 7 4 8 3 6 4 7	D 1 0 0 0	

← Input area

↑ Display example for DWOVP K2147483647 D1000

"" moves to the specified direction (left/right) with  or  key.

In this operating manual, the List editor function key is represented in the following abbreviation form.

- (1) Expression of  $\boxed{\text{Key 1}} \rightarrow \boxed{\text{Key 2}} \rightarrow \dots \rightarrow \boxed{\text{Key n}}$  means the sequential input from  $\boxed{\text{Key 1}}$  to  $\boxed{\text{Key n}}$ .
- (2) Expression of  $\boxed{\text{Key 1}} + \boxed{\text{Key 2}}$  means input of  $\boxed{\text{Key 1}}$  and  $\boxed{\text{Key 2}}$  at the same time.
- (3) As in  $\boxed{\text{RST}}_0$  key or  $\boxed{\text{MOV}}_M$  key, keys with dual functions for input of the command or the device/constant or control keys that control the List editor function are represented as follows:

(a) The mode command or only alphanumeric characters are described.

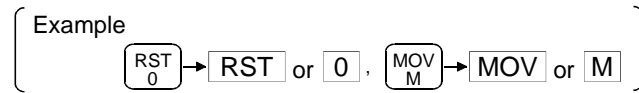

(b) Only commands are shown for explanation of command input. (Alphanumeric characters are omitted.)

Only alphanumeric characters are shown for explanation of alphanumeric characters. (Command expressions are omitted.)

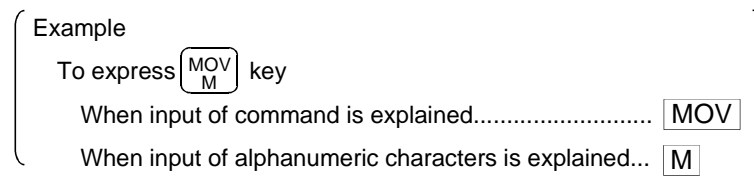

3.5.5 Display format on the display

The following describes the position and content of each data field in the display area provided by the List editor function.

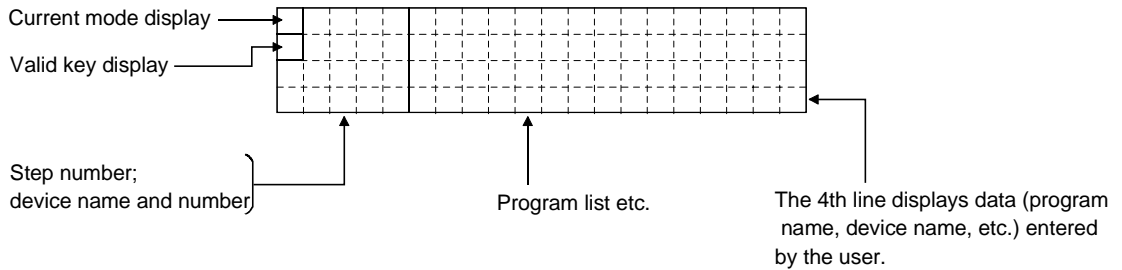

(1) Mode and valid key display

The following describes the mode and valid key display.

The mode display shows the list editor function mode selected by the user.

The valid key display shows which of the two functions assigned to each key is currently available: the function indicated at the upper part of the key or the function indicated at the lower part of the key.

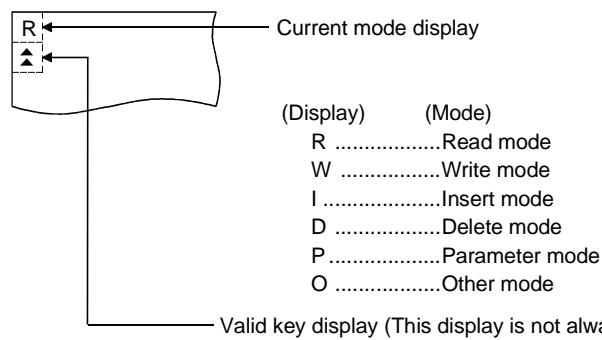

With regard to keys framed in dotted lines in the figure shown at the left, the valid key display indicates which of the two functions assigned to each key is valid:

- ▲ : Function indicated at the upper part of each key is available.
- ▼ : Function indicated at the lower part of each key is available.

Example: FROM key

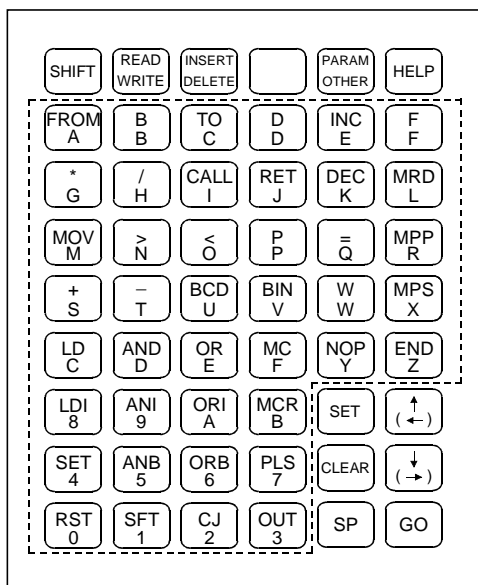
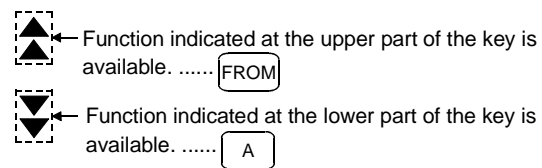

<b>POINTS</b>
To switch between two functions of keys (functions indicated at upper and lower parts of the keys), press the <b>SHIFT</b> and <b>SET</b> keys. For details, see Section 20.1.1

(2) Cursor display

The GOT controls the display of the cursor when the user has to input data; it displays a "■" at the cursor position. For more information, see Paragraph (6) below.

If the cursor overlaps the display of a character, however, the character and "■" alternate on the display.

(3) Indication of the selected line

When a program list is displayed, the line currently selected for editing is indicated by "▶" appearing immediately after the step number.

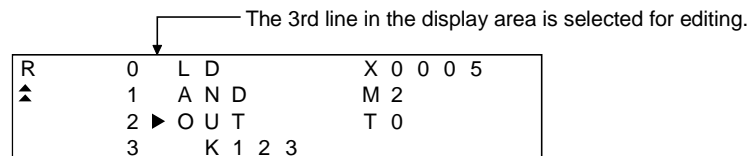

You can use the  and  keys to move "▶" up and down.

(4) Step number display

A step number is displayed as a decimal number.

On the 1st and 2nd lines in the display area, significant digits in the lower four digits of a step number are displayed.

On the 3rd and 4th lines in the display area, up to five significant digits in a step number are displayed.

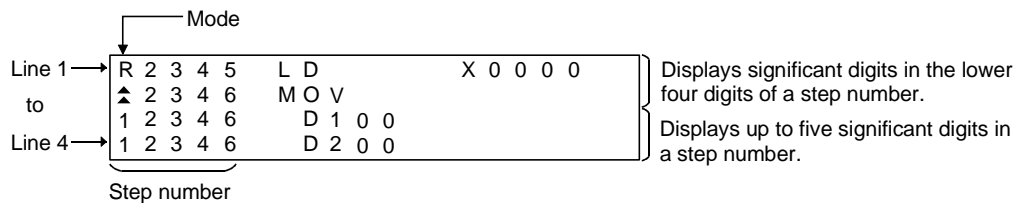

(5) Device display

Two or more device specifications attached to a basic or application instruction are displayed using the same step number.

For information on the step numbers, see Paragraph (4) above.

(6) Display of data input from the keys

Data input from the keys will appear at the cursor position. As more characters are input, the cursor moves to the right.

The cursor appears as "■".

Example: The user enters  →  →

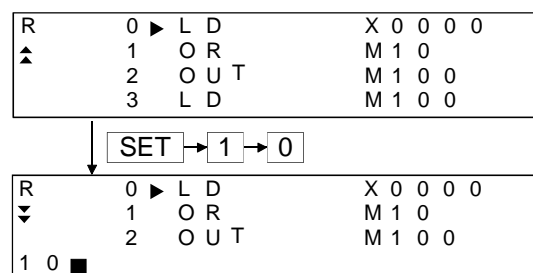

(7) Shifting of data to the left during the input of a program

When the user inputs a program, the codes entered before a touch on the **GO** key will appear on the 4th (bottom) line of the display area.

If the codes cannot appear on a single line, the display on the 4th line only will shift by a single character position to the left each time the user touches a key. (Each character that goes out of the display area by the left-shift operation is retained in the memory.)

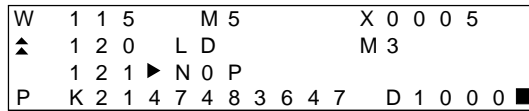

The user has entered "DMOV P K2147483647 D1000".

(8) Numerical display

The following describes the display of numerical values in devices and of constants in a program input by the user. Note, however, that only some examples are shown. For details, see Chapter 20.

Example: D1000 **4231H**

1) Display in decimal format

Only significant digits are displayed with zero-suppression.



2) Display in hexadecimal format

Four digits are displayed without zero-suppression.



3) Display in octal format

Six digits are displayed without zero-suppression.



4) ASCII format

A numerical value in the specified device is read in byte units and converted into associated character codes.

If a value fell outside the ranges 20H through 7FH and A0H through DFH, dots "." will appear.

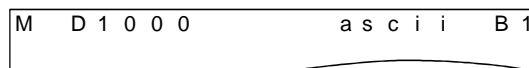

(9) Display of an error message

An error message will appear on the 4th line of the display area.

If an error message appears, perform corrective action as described in Chapter 21.

An error message on the display is cleared when you press any key. Then the display resumes the state before the appearance of the error message.

3.5.6 List of List editor function

Mode (mode display)	Function				Action
Write (W)	Write program				Writes, adds, or modifies a program.
	Change device				Changes a device used at the selected step in the program
	Help	Write	Instruction help	Display/select instruction	Displays a list of instructions that start with the specified character and allows the user to choose from them.
				Read step	Reads a program after allowing the user to specify a step number.
		NOP continuous		Declares the specified part of the program NOP.	
Comment display				Displays a comment for the specified device.	
Read (R)	Read program				Reads a program after allowing the user to specify a step number. Reads a program after allowing the user to specify an instruction used. Reads a program after allowing the user to specify a device used.
	Automatic scrolling				Automatically scrolls the display of a program that has been read up to a specified step.
	Help	Read	Step	Corresponds to program read and automatic scroll functions described above.	
			Instruction		
			Device		
Automatic scrolling					
Comment display				Displays a comment for the specified device.	
Insert (I)	Insert program				Inserts a new program into the displayed program.
	Help	Insert	Instruction help	Display/select instruction	Displays a list of instructions that start with the specified character and allows the user to choose from them.
				Read step	Reads a program after allowing the user to specify a step number.
		Move		Moves the selected part of the program to a specified part of the program.	
	Copy		Copies the selected part of the program to a specified part of the program.		
Comment display				Displays a comment for the specified device.	
Delete (D)	Delete program				Deletes a program at the specified step.
	Help	Delete	Specified block	Deletes the specified block in the program.	
			All NOPs	Deletes all NOP instructions found in program codes described before the END instruction. (NOPLF instructions will not be deleted.)	
Comment display				Displays a comment for the specified device.	
Parameter (P)	Clear all parameters				Clears all parameters in the ACPU only.
	Set parameter				Sets or changes various parameters like those for the memory capacity, timer/counter, and latching range. Sets or changes a keyword.

Mode (mode display)	Function		Action	
Others (O)	Change T/C set values		Changes values set to timer/counter devices.	
	PC check	Read erroneous step	Displays details of an error in the ACPU and the associated step number.	
		Program check	Checks duplex coils, instruction codes, and other elements in the program.	
	PC system	Monitor	Buffer memory batch monitor	With regard to a special function unit of the specified I/O number, monitors the contents of the buffer memory at the specified address.
			Clock monitor	Monitors the ACPU clock (D9025 through D9027).
		Monitor All clear	PC memory	Clears all contents of the ACPU memory and resets it to the initial state.
			Program	Clears the program (Main/Sub) currently selected.
			Device memory	Clears all device memories except for special-D, special-M, and R.
		Switch	PC No. setup	Switches the target ACPU in GOT operations in each mode.
			Switch Main/Sub	Switches the target program (Main/Sub) in GOT operations in each mode.
		Others	Remote RUN/STOP	Forcibly changes the ACPU running status between RUN and STOP.
	Machine language read/write		Performs a read or write operation to the ACPU memory in the machine language.	

## Chapter4 Operating the utility function

## 4.1 Utility function table

Functions	Description	Remarks	Ref. section
Brightness/contrast adjustment	Adjusting the brightness/contrast of a monitor screen.	This function changes with the GOT used.	Section 4.3
System monitor	Monitoring or changing devices in a PLC CPU.	This function can be executed only after installing an OS on the GOT by using drawing software.	Chapter 9
Special module monitor	Monitoring or changing buffer memory of a special module.	This function can be executed only when the GOT memory is extended and the OS is installed from the drawing software to the GOT.	Chapter 12
Screen & OS copy	Copying of screen data between internal memory and memory card Copying of OS data between internal memory and memory card	Refer to the HELP function of SW4D5C-GOTR-PACKE to install the OS (from memory card to internal memory).	Section 4.4
Setup	The options of settings include: <ul style="list-style-type: none"> <li>• Language used in a message display (Japanese/English)</li> <li>• Buzzer sound adjustment</li> <li>• Sounds from an external speaker</li> <li>• Idle time for a screen saver</li> <li>• Backlighting for a screen saver</li> <li>• Protocol and baud rate when connected to a microcomputer</li> <li>• Reverse display</li> <li>• Extension number and slot number for bus connection with QCPU</li> <li>• Transmission speed for Computer link connection</li> <li>• Transmission speed for Yasukawa PLC connection</li> <li>• Transmission speed and address for SIEMENS PLC connection</li> <li>• Grip switch enable/disable setting (A950 handy GOT only)</li> </ul>	—————	Section 4.5
Self-test	The self-test include diagnostic checks on GOT hardware as follows: <ul style="list-style-type: none"> <li>• Drawing check</li> <li>• Font check</li> <li>• Memory card check</li> <li>• User-space-in-the-internal-memory check</li> <li>• OS-space-in-the-internal-memory check</li> <li>• CPU communications check</li> <li>• Touch key check</li> </ul>	—————	Section 4.6
Memory information	The contents of GOT memory information include: <ul style="list-style-type: none"> <li>• OS version number</li> <li>• Status of communications with the PLC CPU</li> <li>• Available space in the internal memory</li> <li>• Availability of memory cards and available space in a memory card</li> <li>• Availability of the ladder monitor function</li> </ul>	—————	Section 4.7
Ladder monitor	Monitoring the sequence programs on the PLC CPU.	This function can be executed only when the GOT memory is extended and the OS is installed from the drawing software to the GOT.	Chapter 6
Clock	Setting date and time.	—————	Section 4.8
Screen cleanup	Displaying the display area cleanup screen.	—————	Section 4.9
Network monitor	Monitoring the line status of MELSECNET.	This function can be executed only when the GOT memory is extended and the OS is installed from the drawing software to the GOT.	Chapter 17
Security password	Changing the security levels of numeric input and objects.	If a security password is defined by using drawing software, security levels can be changed.	Section 4.10
Password	Defining a password for limited access to the utility menu screen.	—————	Section 4.11
List edit	List editing of PLC programs in PLC CPU	This function can be executed only when the GOT memory is extended and the OS is installed from the drawing software to the GOT.	Chapter 19



4.2 Selecting the utility function

This section describes how to select the utility function.

The utility function can be activated with a touch of the screen.

To select the utility function, follow either of the following two steps.

- (1) Touch the upper right and left corners of the screen at the same time.

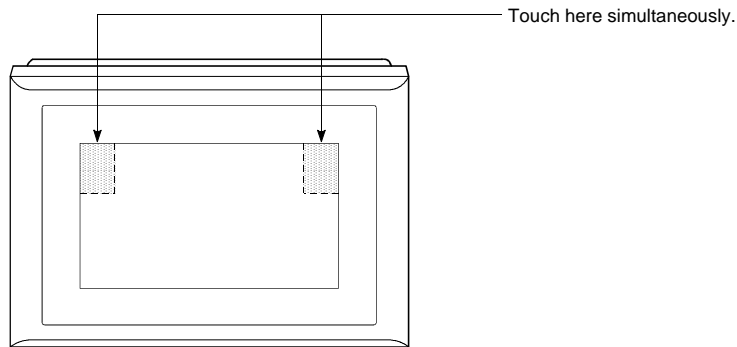

- (2) Touch a touch key displayed on the monitor screen. A touch key can be set in the touch key (expanded) function settings.

The following flowchart outlines the steps involved in selecting the utility function.

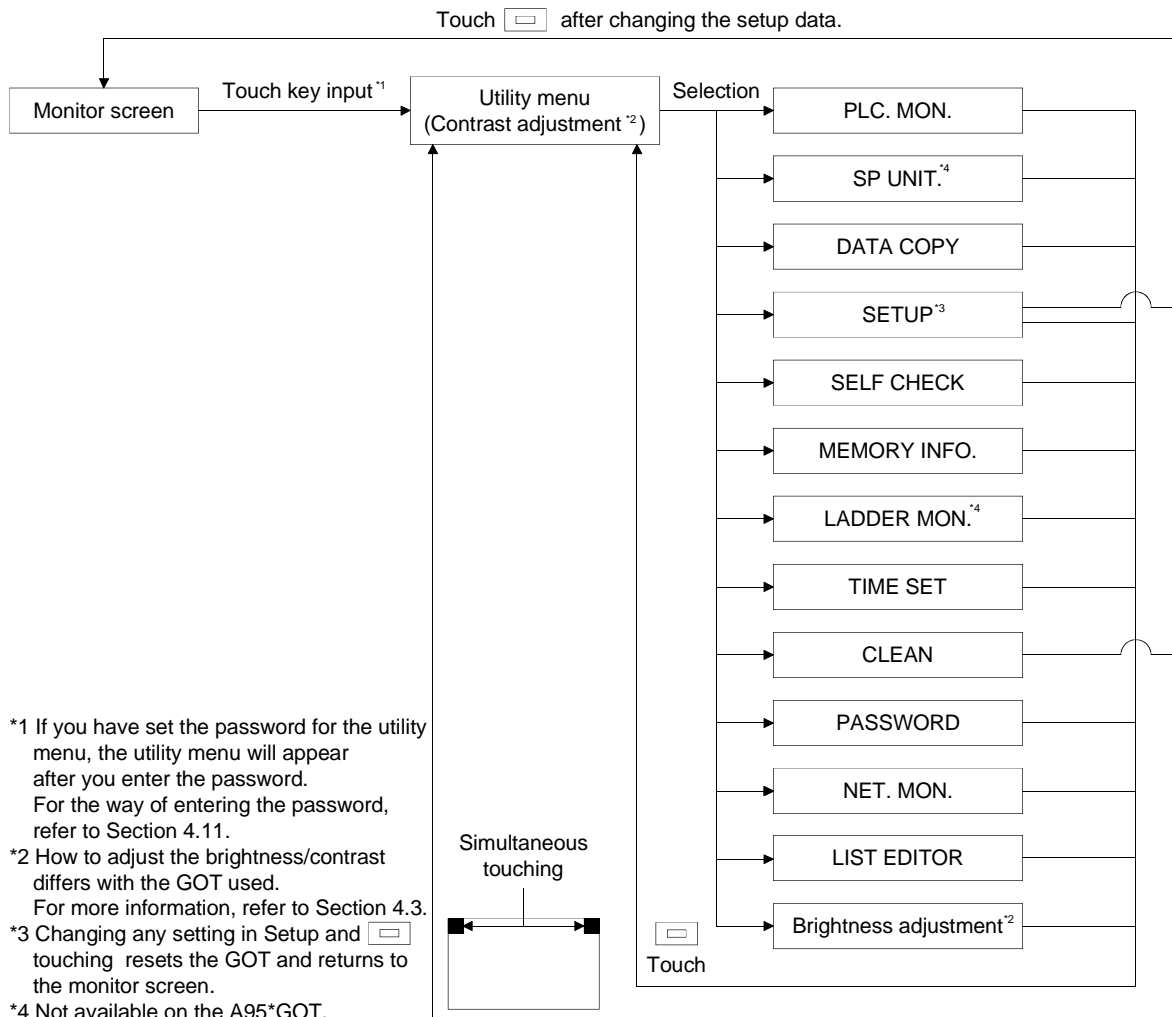

4.3 Selecting the required function on the utility menu screen (Adjusting the brightness/contrast of the monitor screen)

(1) Display screen

The display screen differs with the GOT used.

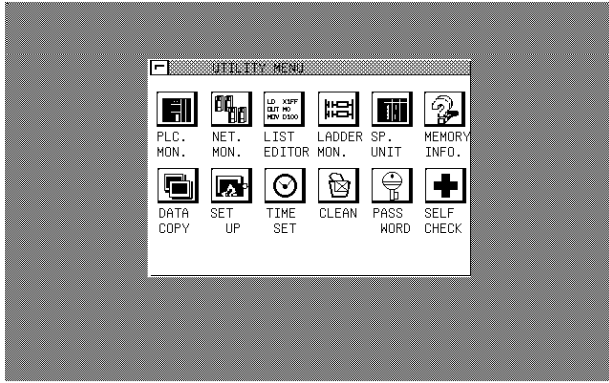
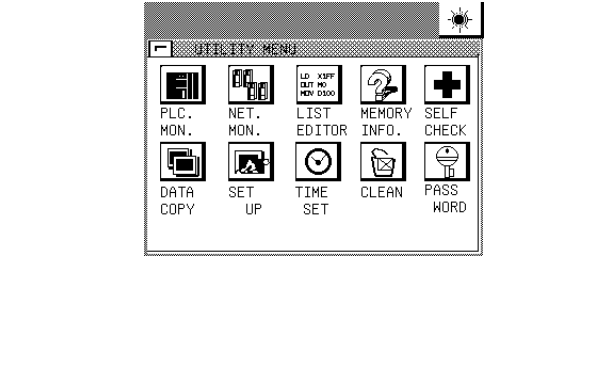
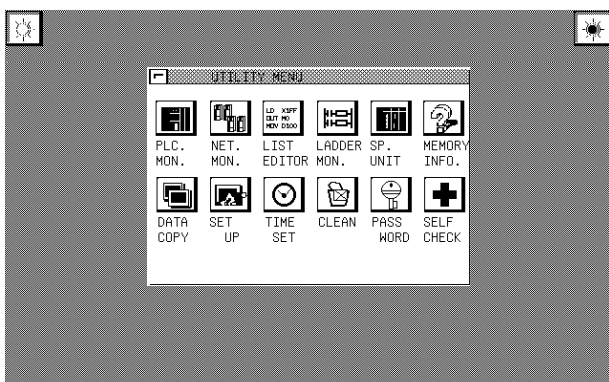
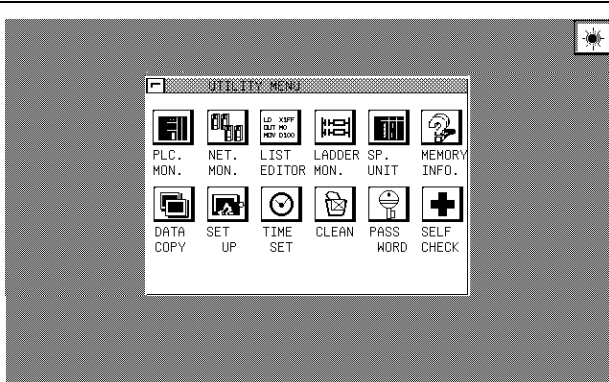
Screen Example	
A985/97*/960GOT	A95*GOT
	
	
	

(2) Function

- Menu screen used to select any of the utility functions.
- Used to adjust the brightness/contrast of the monitor screen.

(3) Operation



(a) Basic operation

Directly touch the portion where the function you will select is being displayed.

(b) Return to the monitor screen

Touch  to return to the monitor screen.

(c) Brightness/contrast adjustment

- Touch   and at top of the screen to make contrast adjustment.
- You can adjust the contrast in about 20 steps.
- Touch  at top right of the screen to show the brightness adjustment-dedicated screen.

For details of the adjustment method on the dedicated screen, refer to section 4.12.

POINTS
<ul style="list-style-type: none"> <li>• If the OS is not installed on the GOT, items are displayed on the system monitor, but they cannot be selected.</li> <li>• If the memory board is not installed in the GOT or the OS is not installed on the GOT, items are displayed on the special unit monitor, the ladder monitor and the network monitor of the A985/97*/960GOT, but they cannot be selected.</li> <li>• If the compatible model (A95*GOT-*BD-M3) is not used or the OS is not installed on the GOT, items are displayed on the network monitor of the A95*GOT, but they cannot be selected.</li> <li>• If the GOT is connected to the PLC CPU without clock function, items are displayed on the clock window, but they cannot be selected.</li> </ul>

(4) On-screen error messages

Message	Cause	Corrective Action
Can't be selected (When system monitor, special module monitor, ladder monitor, or clock setting is selected)	<ul style="list-style-type: none"> <li>• The OS is not installed on the GOT.</li> <li>• The memory board is not installed in the A985/97*/960GOT.</li> <li>• The A95*GOT other than the compatible model (A95*GOT-*BD-M3) is used.</li> <li>• The GOT is connected to a PLC CPU without a clock function.</li> </ul>	<ul style="list-style-type: none"> <li>• Install the OS.</li> <li>• Install the memory board in the A985/97*/960GOT.</li> <li>• Use the compatible model (A95*GOT-*BD-M3).</li> <li>• Replace the CPU with one with a clock function or do not use the clock setting.</li> </ul>

4.4 Copying the monitor data/OS data between the internal memory and memory card (Screen & OS copy)

(1) Display screen

Sample screen

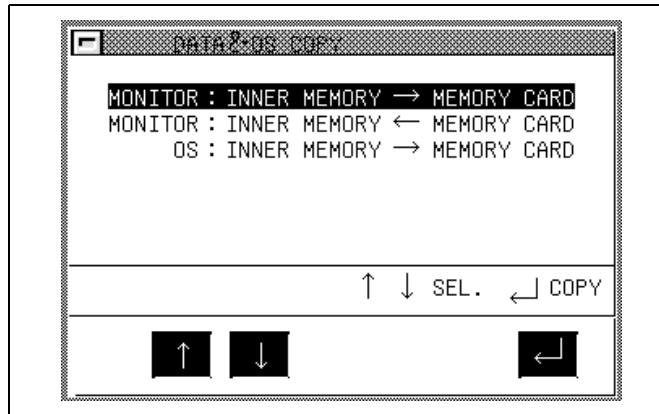

(2) Features

- Project data stored in the internal memory can be saved to the memory card.
- Project data stored in the memory card can be saved to the internal memory.
- OS data can be backed up by copying them from the internal memory to the memory card.

(3) Procedure

(a) Basic operation

- Touch or to select options.
- Touching will display a message asking you to answer the question "Do you want to execute? "
- If you answers Yes to the question, touch again. Touch or to select another option. To quit the backup copy, touch to return to the Utility Menu screen.

(b) To return to the Utility Menu screen:

- Touch to return to the Utility Menu screen.

(4) On-screen error messages

Message	Cause	Corrective Action
Cancel write protect function	The memory card is write-protected.	Release write protection of the memory card.
Install memory card	A memory card is not installed on the GOT.	Install a memory card on the GOT.
Format memory card	The installed memory card is not yet formatted.	Format the memory card.
Write Error (M-CARD capacity shortage) Data transfer error	Memory card loaded has memory space less than written data.	Change the memory card for the one having enough memory space.
M-CARD error Data transfer error	Write error occurred in the memory card during copying, or the memory card used has no free space.	Change the memory card, or increase the free space of the memory card.
Memory card error	The hardware of the installed memory card is defective.	Replace the memory card with a new one.

(5) Directory tree in a memory card

The directory tree in a memory card is shown as follows.

(Directory Tree)

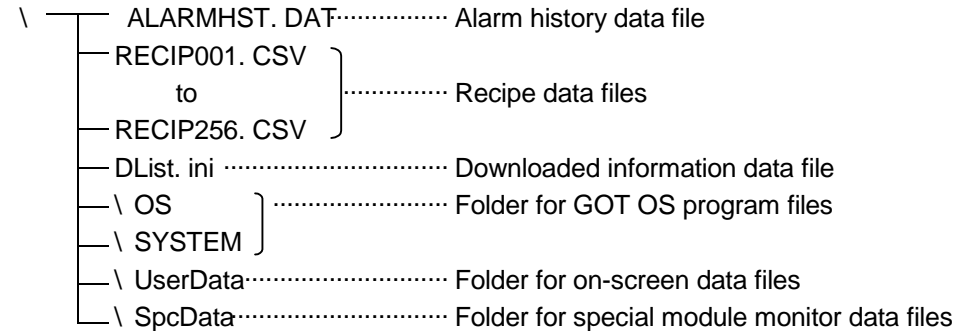

- Backup copies of screen data files are saved to the UserData folder.
- To delete a file from the memory card by operating from the GOT, perform a memory card check, one of the options of the utility function. After the memory card check is complete, the memory card will be formatted.  
To delete a file from the memory card by operating from the personal computer, install a memory card on the GOT and use the Explorer to delete the file.
- Since an OS and data are controlled by the Dlist.ini file, create a memory card by using OS Install or OS Download of drawing software.  
When data is copied by using the Windows explorer on the personal computer side, the data cannot be recognized by the GOT.

POINTS	
	You cannot use this function to install the OS (from memory card to internal memory). For details of OS installation, refer to the Help function of SW4D5C-GOTR-PACKE.

4.5 Setting the operating environment of the GOT (Setup)

**POINT**

After changing any of the items in Setup, touching  automatically resets the GOT and shows the monitor screen.

(1) Display screen

The display screen differs with the GOT used.

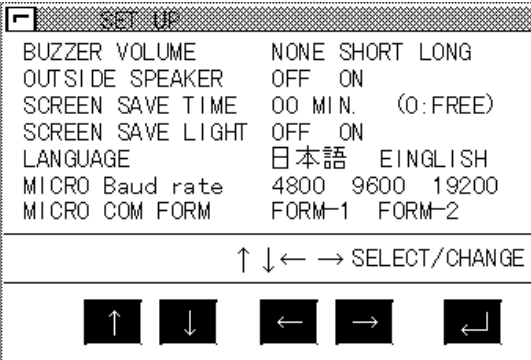
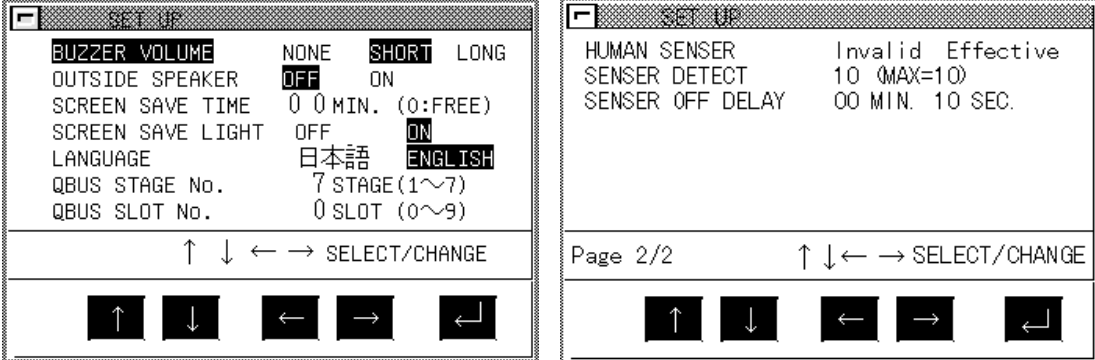
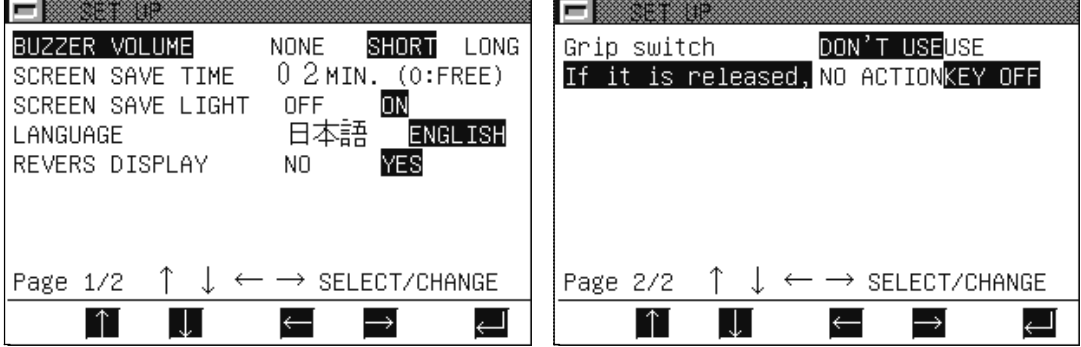
GOT Used	Screen Example
A97*GOT/ A960GOT	
	This screen example assumes that the communication driver "Computer" has been installed.
A985GOT	
	This screen example assumes that the communication driver "Bus (Q)" has been installed.
A95*GOT	
	This screen example assumes that the communication driver other than "Computer", "Bus(Q)", "AJ71QC24", "YASUKAWA GL/CP9200(SH/H)", and "SIEMENS S-300/400" has been installed. The grip switch setting and grip switch cancel-time key OFF setting are available only for use of the A950 handy GOT.

## (2) Functions

- Buzzer volume  
You can select the length of the beep sound.(Factory-set to SHORT)
- Outside speaker sound  
You can select whether or not voice output is provided from the external speaker (only the voice specified for the touch input sound on the drawing software).  
(Factory-set to OFF)
- Screen save time  
Set the time until the monitor screen display is switched off by the screen saver function.  
When this setting is "0", the monitor screen is always displayed.(Factory-set to 0)
- Screen save light  
When this setting is OFF, the backlight goes off as soon as the display is erased by the screen saver function.  
When this setting is ON, the display will disappear but the backlight will not go off.
- Reverse display  
The display mode (normal display (No)/highlighted display (Yes)) is selected.  
(Only A95\*GOT-LBD (-M3) can be selected. Normal display is set at the time of shipment.)
- Language  
You can select the language (Japanese or English) of the messages to be displayed on the screen. (Factory-set to Japanese)
- QBUS extension number  
Set the GOT extension number for bus connection to the QCPU.  
(Factory set to extension 7)
- QBUS slot number  
Set the slot number where the GOT is assigned for bus connection to the QCPU.  
(Factory set to slot 0)
- Microcomputer connection baud rate  
You can select the transmission speed when the GOT is connected to a microcomputer.(Factory-set to 19200)
- Microcomputer connection communication form  
You can select the protocol when the GOT is connected to a microcomputer.  
(Factory-set to FORM-1)
- QC24 Baud rate  
Set the transmission speed for connection with the QC24N.  
(Factory-set to 19200bps)
- Baud rate  
Set the transmission speed for connection with the Yaskawa PLC or SIEMENS PLC. (Factory-set to 19200bps)
- Adapter address  
Specify the MPI address on PROFIBUS assigned to the HMI adapter connected to the GOT for SIEMENS PLC connection. (Factory-set to 1)
- Host (FF) address  
Specify the MPI address on PROFIBUS assigned to the PLC CPU to which the HMI adaptor is connected for SIEMENS PLC connection.  
The specified PLC CPU is the "host" when monitor device setting is made on the drawing software.  
For details of monitor device setting, refer to the help function of SW4D5C-GOTR-PACKE. (Factory-set to 2)

- Screen save Human sensor  
You can select whether the screen saver is deactivated or not when the Human sensor has detected a man's motion. (Available for the A985GOT only, factory-set to Invalid)
- Human sensor detection sensitivity  
You can select the detection sensitivity of the Human sensor in any of 11 steps, levels 0 to 10, so that the sensor will not detect a motion such as a man passing before the GOT. (Available for the A985GOT only, factory-set to 10)

Detection sensitivity setting	10	9	8	7	6	5	4	3	2	1	0
Monitor time [sec]	0	0.1	0.2	0.4	0.8	1	1.5	2	2.5	3	4

- Human sensor OFF delay  
The Human sensor can be turned off when it does not detect a man's motion after it has turned on. You can set that period between "00 min. 10 sec." and "60 min. 00 sec.". (Available for the A985GOT only, factory-set to 00 min. 10 sec.)
- Grip switch  
You can set whether the grip switch will be used or not. When the setting is USE, hold down the grip switch and perform operation. Setup and self-diagnostic operations can be performed independently of the grip switch. (May be set only for the A950 handy GOT, factory-set to USE)
- If it is released  
You can set whether the touch key pressed on the GOT display will be turned off or not at the time of grip switch cancel. At the setting of "NO ACTION", the pressed touch key is turned off when it is released. (May be set only for the A950 handy GOT, factory-set to KEY OFF)

**POINT**



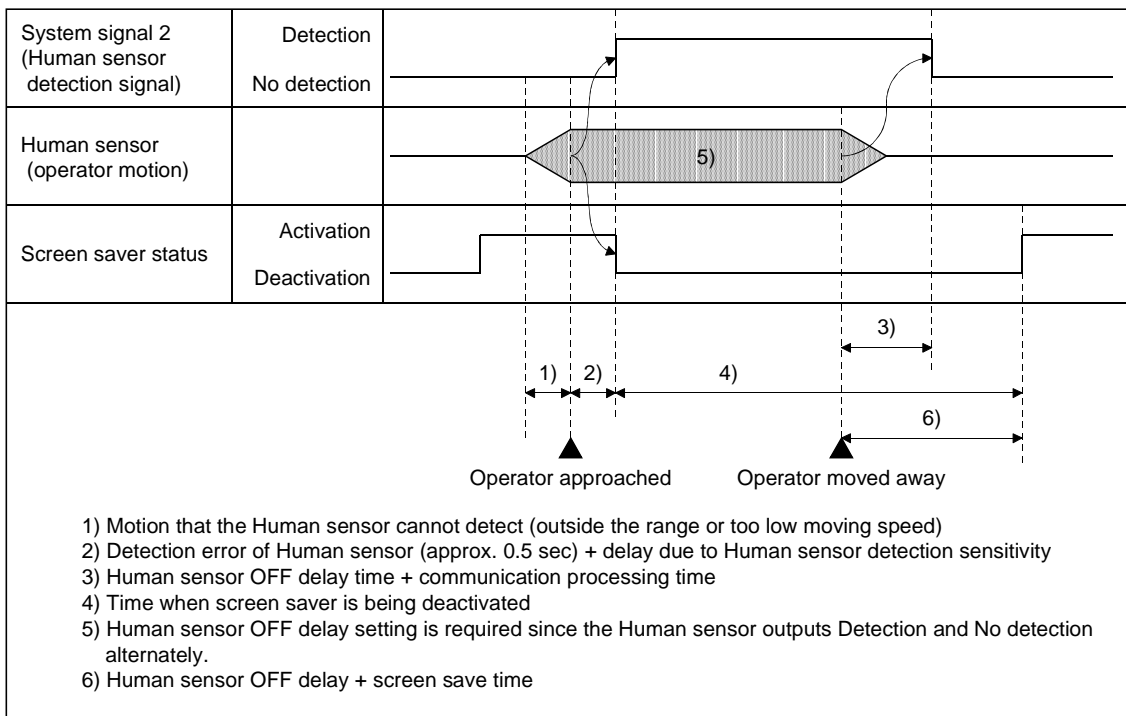









- If the touch panel is not touched within the specified time, the screen saver function switches off the display to prevent "burn-in" of the display device. Especially for the display screen type of EL, it is recommended to use this function.
- Dedicated to the A985GOT, the Human sensor function automatically deactivates the screen saver, without any touch on the touch panel, by means of a signal detected by the Human sensor. Using the system information function of the GOT, the signal detected by the Human sensor may also be controlled by the PLC CPU. For full information on the system information function, refer to the SW4D5C-GOTR-PACKE HELP function. Signal detection timings are shown below.







## (3) Operation

## (a) Basic operation

- Touch  or  to select the necessary item.
- When the A985GOT, A950 handy GOT is used, select the last item on Page 1/2 and touch  to show Page 2/2.
- For the setting item whose value will be changed, highlight the digit to be set by touching  , and set the value by touching  or .
- (If you are going to select another setting item after that, return the highlight to the setting item by touching , and make selection by touching  or .)
- After setting, touch .
- After touching , the GOT is automatically reset and the monitor screen appears.

## (b) Return to each screen

- If no change has been made to the Setup settings, touching  returns to the utility menu screen.
- If any change has been made to the Setup settings, touching  resets and restarts the GOT.  
The display returns to the utility menu or monitor screen.

4.6 Running diagnostic checks on GOT hardware (self-test)

(1) Display screen

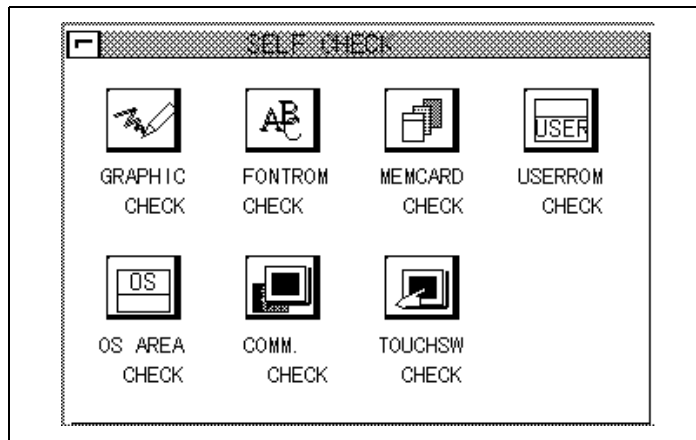

(2) Features

Diagnostic checks on GOT hardware include the following options:

- Graphic Check ..... Allows you to perform visual inspection on screen display for discoloration and lack of display.
- Fontrom Check ..... Allows you to perform visual inspection for deformation in font size.
- Memcard Check..... Allows you to make a check on the hardware of a memory card. After checking, a memory card are initialized.
- Userrom Check..... Allows you to check for user space in the internal memory. After checking, user space is cleared to delete any data contained in the user space.
- OS Area Check..... Allows you to check for OS space in the internal memory.
- Comm. Check ..... Allows you to check for GOT-to-PLC CPU communications.
- Touchsw Check ..... Allows you to check for touch keys.

The GOT performs these checks.

(3) Procedure

(a) Basic operation

- Select the desired button to perform a diagnostic check.
- Select options as instructed on-screen.
- You will see a message indicating that the selected diagnostic check was successfully completed.
- If an error is detected, you will see a message indicating the occurrence of the error.
- The Image Check allows you to view the following elements:
  - 1) The entire screen is displayed in one color. Display colors are changed in the order of red-green-blue.
  - 2) Basic figures are displayed, including circles and squares.
  - 3) Ellipses and checkered patterns are tiled or cascaded on-screen.

## 4.7 Displaying GOT memory information (memory information)

## (1) Display screen

Sample screen

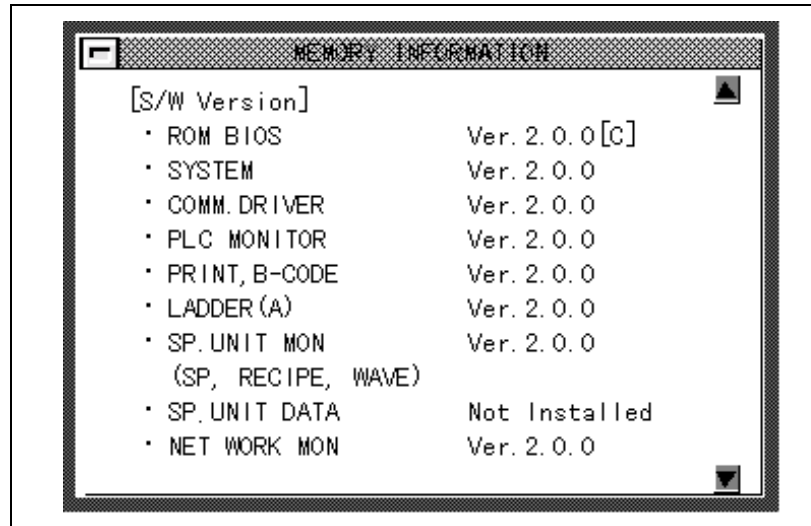

## (2) Features

The contents of GOT memory information include:

- OS version number
- Status of communications with the PLC CPU
- Available space in the internal memory
- Availability of memory cards and available space in a memory card
- Availability of the ladder monitor function

## (3) Procedure

## (a) Basic operation

Touch ▲ ▼ to scroll screens.

## (b) To return to the Utility Menu screen

Touch ☐ to return to the Utility Menu screen.

4.8 Setting the Clock (Clock)

(1) Display screen

Sample screen

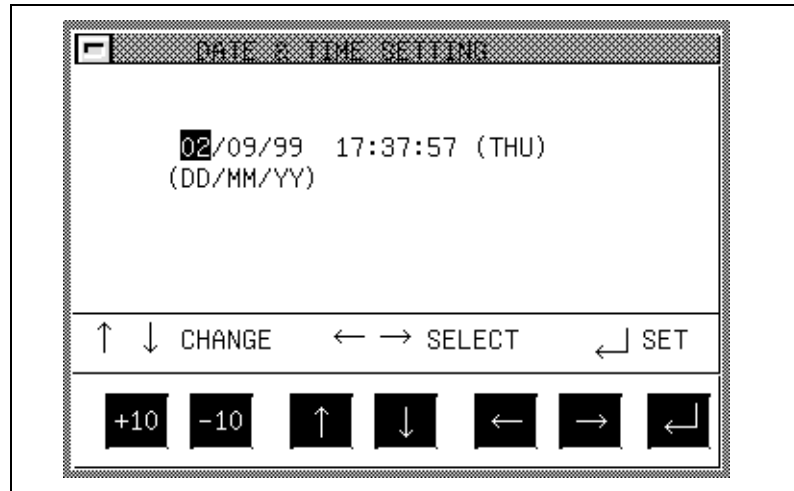

\* The time when the Clock Settings screen was displayed is shown in the window panel. The time indicator in the upper-right corner of the screen shows the current time. After correcting the date or time, check the clock for the current time.

(2) Features

- The date, time, and a day of the week can be set to adjust the clock of the PLC CPU and the A9GT-RS2T.

(3) Procedure

(a) Basic operation

- Touch to select the desired option.
- Touch or to change numeric values.
- Touch or to to change the numerical values in increments of 10.
- Touch to set the clock of the PLC CPU.

(b) To return to the Utility Menu screen

- Touch to return to the Utility Menu screen.

POINTS
<ul style="list-style-type: none"> <li>• Adjust the clock when you start up the system.</li> <li>• The clock cannot be properly adjusted while reading or writing clock data by running sequence programs on the PLC CPU side (or when M9028 is turned on by sequence programs in the case of the ACPU).</li> <li>• This option is not selectable from the Utility Menu screen when connected to the PLC CPU that has no clock function.</li> <li>• This option is not selectable when the A9GT-RS2 is used for microcomputer connection.</li> </ul>

4.9 Displaying the display area cleanup screen (screen cleanup)

(1) Display screen



(2) Features

- A black screen is displayed when cleaning up the display area. This makes the screen easy to view.

(3) Procedure

(a) Basic operation

- Touch the upper right and left corners of the screen at the same time to return to the Utility Menu screen.

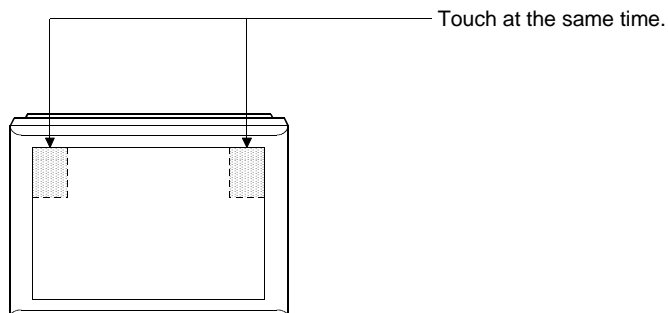



## 4.10 Changing security levels (security password)

## (1) Screen display









## (2) Features

- If objects (numeric input or touch keys, etc.) are secured by using drawing software, their security levels can be changed by entering a password.
- If the characters entered match a password, a message appears on-screen, telling that the security levels have been properly changed. Touching  will return to the Utility Menu screen.
- If the characters entered do not match a password, an error message appears on-screen. Touching  will return to the Utility Menu screen.
- Numerical numbers and alphabets [A] to [F] can be used for a password.
- Details about security levels, see SW4D5C-GOTR-PACKE(V) Operating Manual (Drawing Software Manual).

## (3) Procedure

## (a) To enter a password, follow these steps:

- Touch  to  and  to  to enter a password.
- Touch  to confirm the password entered.
- To correct the password entered, touch  to delete wrong characters and enter correct characters again.

## (b) To quit entering a password:

- Touch  to return to the previous monitor screen.

## 4.11 Controlling limited access to the utility menu (password)

## (1) Screen display

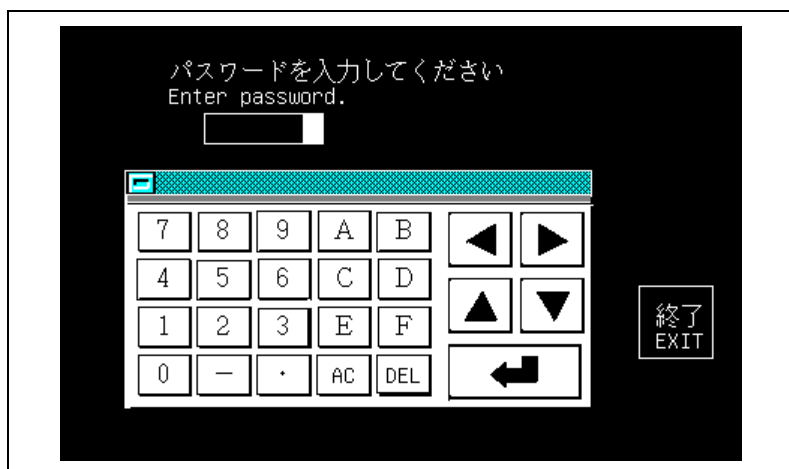

## (2) Features

- Password protection can be set on the GOT by using drawing software. If access to the Utility Menu screen is password-protected, a screen asking you to enter a password is displayed when you touch the upper right and left corners of the screen or when you touch a touch key on the screen.  
A dialog box for defining a password is contained in the common settings menu of drawing software.
- If the characters entered match a password, the Utility Menu screen appears.
- If the characters entered do not match a password, an error message appears on-screen. Touching [EXIT] will return to the previous monitor screen.
- Numerical numbers and alphabets [A] to [F] can be used for a password.

## (3) Procedure

## (a) To enter a password, follow these steps:

- Touch [0] to [9] and [A] to [F] to enter a password.
- Touch [↵] to confirm the password entered.
- To correct the password entered, touch [DEL] to delete wrong characters and then enter correct characters again.

## (b) To quit entering a password:

- Touch [Exit] to return to the previous monitor screen.

4.12 Adjusting the brightness of the monitor screen on the dedicated screen (Brightness adjustment)

(1) Display screen

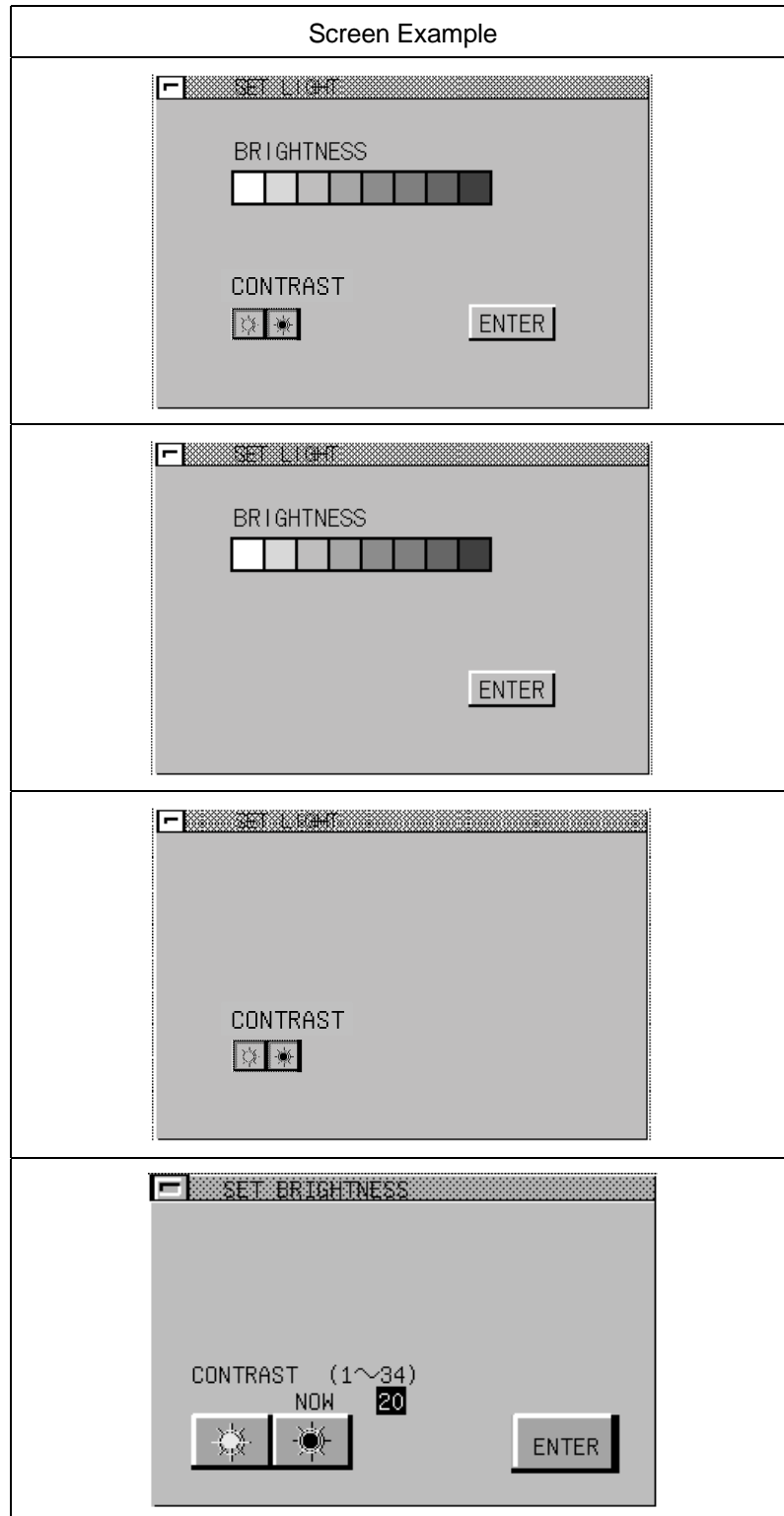







## (2) Function

- Used to adjust the brightness of the monitor screen.

## (3) Operation

## (a) Basic operation

- Touch any of  to  to select the brightness.
- Touch   and at top of the screen to make contrast adjustment.  
You can adjust the contrast in about 20 steps.
- Touch  to store the settings into the GOT.

## (b) Return to the utility menu screen

- Touching  returns to the utility menu screen.

Chapter5 Operation procedures for the ladder monitor function

The operation procedures to follow when using the ladder monitor function are explained in the following section.

5.1 Operation procedures before starting ladder monitoring

This section contains a summary of the procedures for transmitting the system program (OS) for the ladder monitor function from the personal computer to the GOT until it is installed in the built-in memory. For details, please refer to the Help in Drawing Software. Details of the screen display and key operation are shown in the Help.

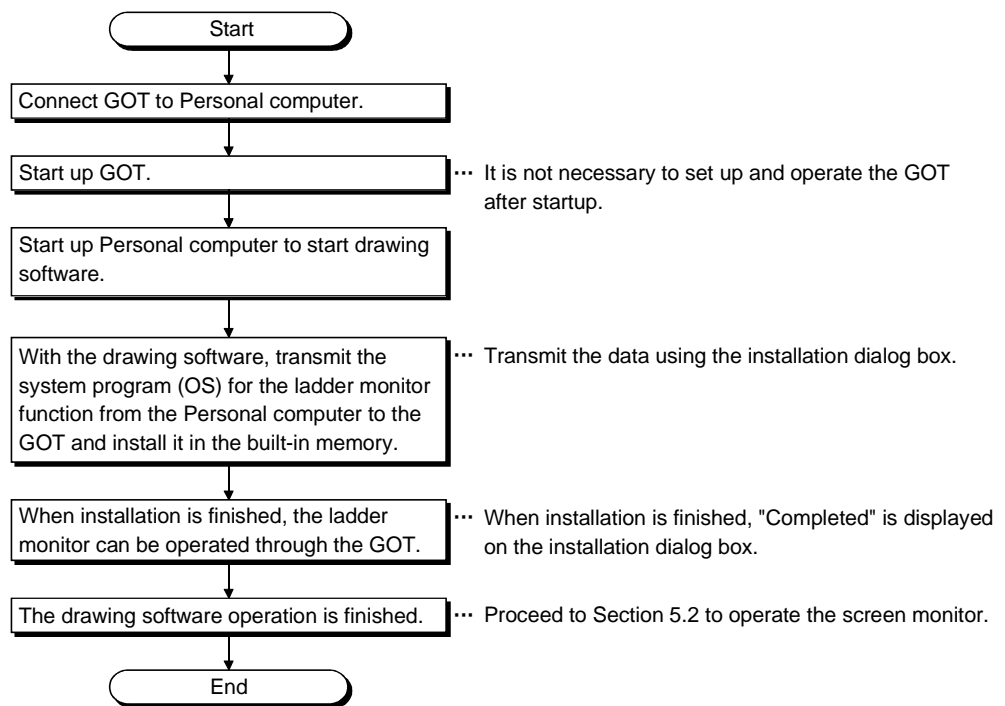

# 5. OPERATION PROCEDURES FOR THE LADDER MONITOR FUNCTION MELSEC GOT

## 5.2 Operation procedures from display of user-created monitor screen to start of ladder monitoring

This section shows the operation procedures for the GOT when starting each operation of the ladder monitor function after the ladder monitor function system program (OS) has been installed in the GOT built-in memory.

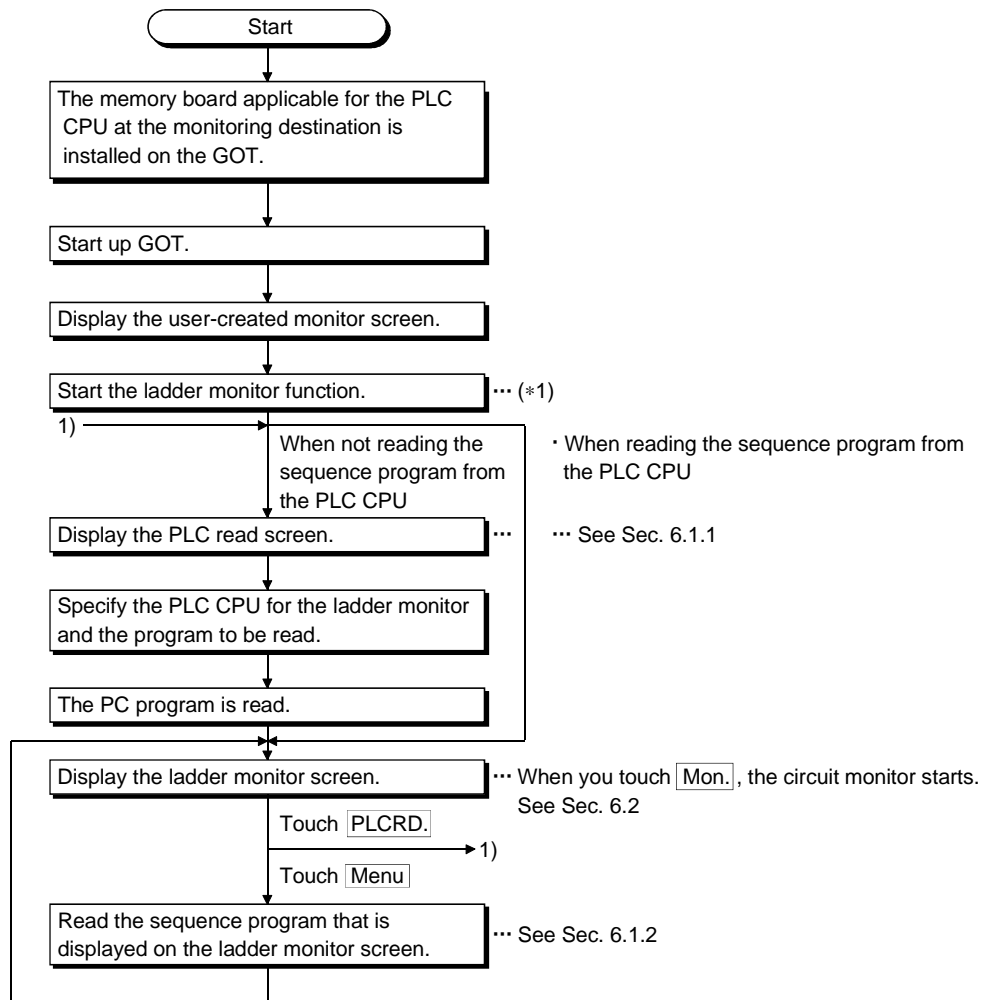

\*1 With the drawing software, touch the key where the touch switch (expanded) function is set, and start the circuit monitor function.  
When the Utility screen is displayed, start the circuit monitor function by touching LADDER MON..

Chapter6 Operating the various ladder monitor screens

The following sections describe each screen operation when using the ladder monitor function.

6.1 Screen operation and screen changes when monitoring

This section includes an explanation of the PLC read operation that reads out the sequence program from the PLC CPU when executing the ladder monitor, the ladder read operation that specifies the sequence program to be displayed on the ladder monitor screen, and the screen movement when executing the ladder monitor.

6.1.1 Reading data from the PLC

The operation of reading the sequence program for the ladder monitor from the PLC CPU is described below.

The operation procedures vary depending on the PLC CPU to be monitored. All of the keys used with the operation are touch keys displayed on the screen. Touch the position where the object key is displayed and enter the data.

(1) When the MELSEC-A/FX ladder monitor is executed

[Operation procedure]

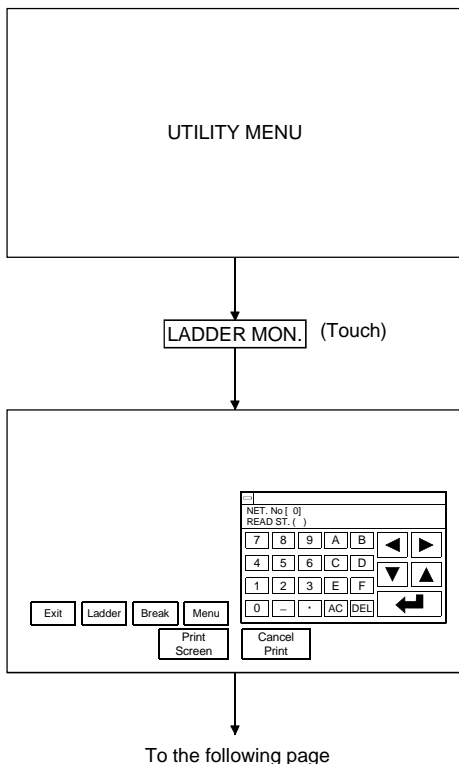

When the ladder monitor function starts up, execution begins from the specified operation with the network No. and Station of the object PLC CPU noted below.

When the screen below is currently displayed, it is not necessary to touch this.

1) Specify the network No. and station No. for the object PLC CPU.(\*1)

(For data link system, CC-Link system)

NET NO : 0  
 READ ST. : FF (Own station)  
 0 (Master station)  
 1 to 64 (Local stations)

(For network system)

NET NO : 0 (Host loop)  
 0 (Master station)  
 READ ST. : FF (Own station)  
 1 to 64 (Control station)  
 1 to 64 (Normal station)

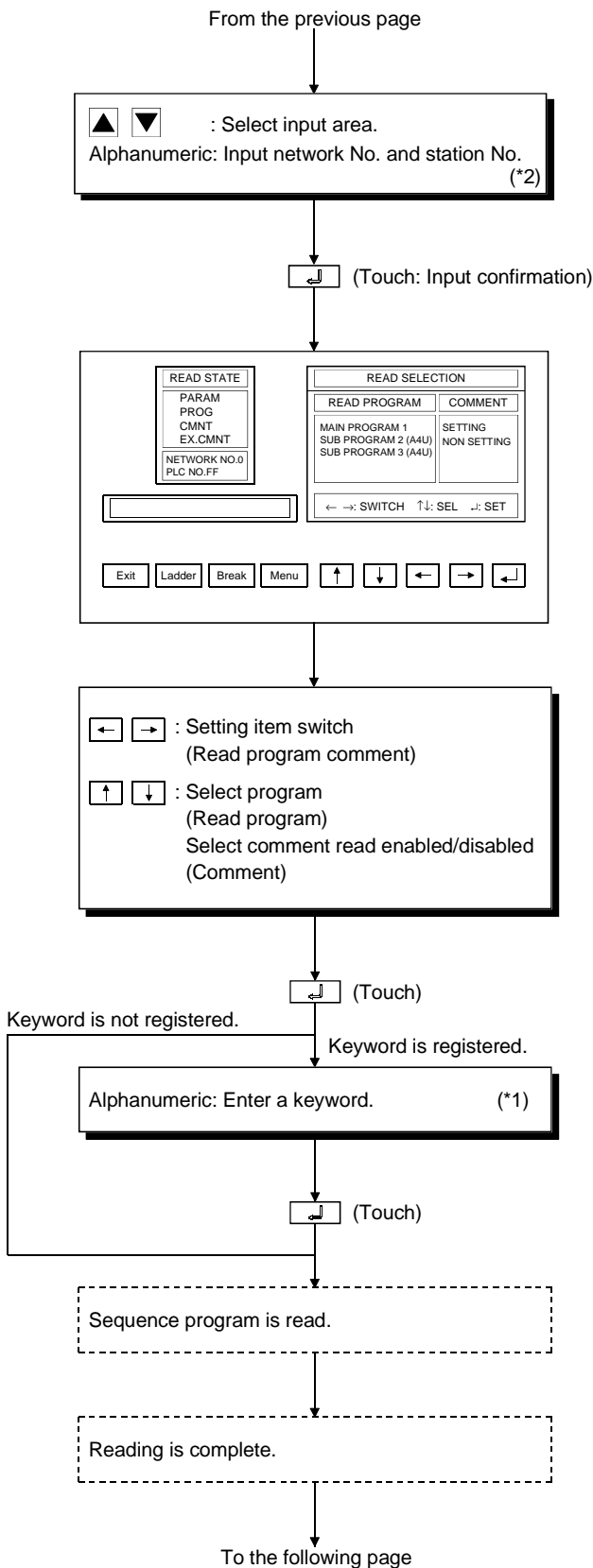

2) In "Read Selection", specify the sequence program to be read from the object station. Specify whether or not to perform comment read.

3) Input the keyword that is registered to that station. If no keyword has been registered, nothing has to be entered.

4) The contents and capacity of the read procedure are displayed. When you touch **Break**, the read procedure is interrupted. When reading resumes, it starts at the beginning.

5) "Completed" is displayed.

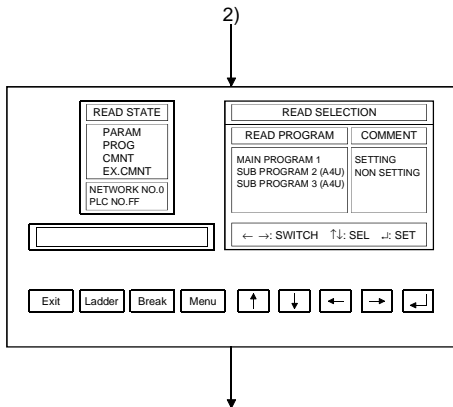

Change screen.

- Exit** : Moves to screen where ladder monitor function starts.
- Ladder** : Moves to ladder monitor screen.
- PLCRD.** : Moves to PLC read screen.

\*1 Data being entered can be cleared by the following keys.

- AC** : Clears all data being entered to the object area.
- DEL** : Clears one character at the cursor position.

**POINT**

Once this data has been read from the PLC, it does not need to be read again. If data for screens created by the user is downloaded from the computer after this data has been read, however, the data will have to be read again.

(2) When the MELSEC-QnA ladder monitor is executed

[Operation procedure]

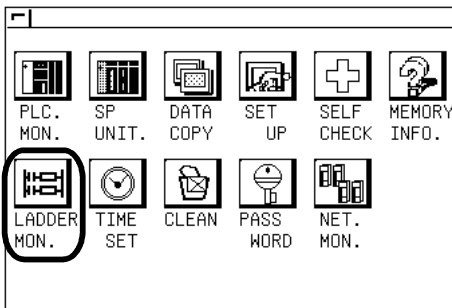

1) Touch the ladder monitor starting touch switch on the monitor screen prepared by the user or touch the **LADDER MON.** on the utility screen to start the ladder monitor function.

**POINT**

If ROM\_BIOS is not installed, an error message is displayed. Touch the **END** button and install the ROM\_BIOS (H version or later).

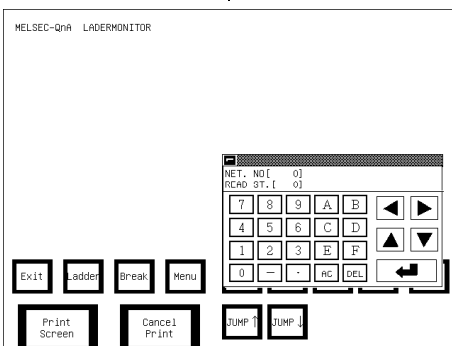

2) The key window is displayed. Set the network No./station No. of the applicable PLC CPU with the following keys.

- : Select the input area.
- Alphanumeric** : Input the network No. and the station No.
- AC** : Clear all input data to the applicable area.
- DEL** : Clear one character at the cursor position.
- : Define the input.

**POINT**

Designate the network No. and the station No. of the applicable PLC CPU.

(For CC-Link system)

Network No. : 0

Station No. : 0 (mask station)

(For network system)

Network No. : 1 to 255 (self-loop)

Station No. : 1 to 64 (control station)

1 to 64 (normal station)

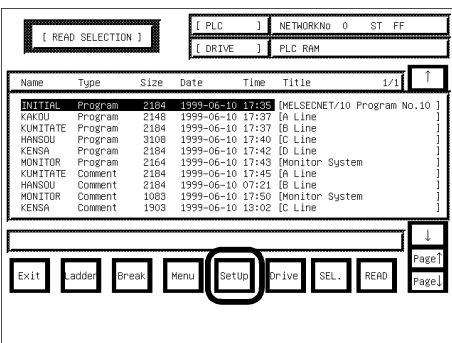

3) The PLC read screen appears. First, touch the **Set Up** key to display the setting window.

To the following page

From the previous page

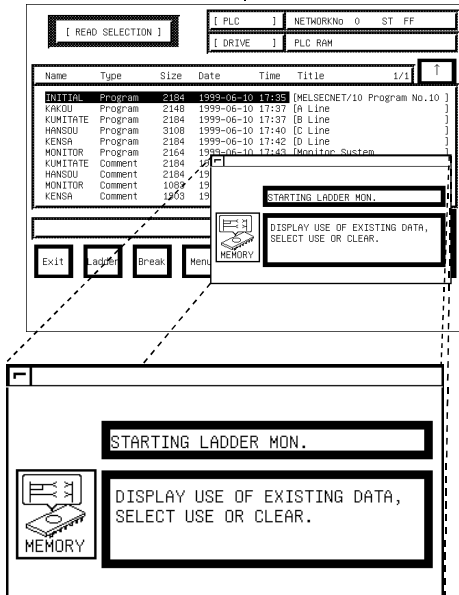

4) The setting window appears.

Make the setting for initial ladder monitor start.

Touching the **MEMORY** key changes the setting choice as indicated below.

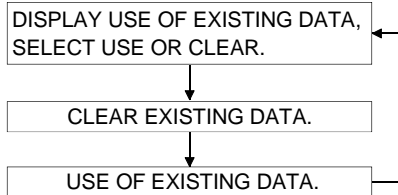

After the setting is over, touch the button.

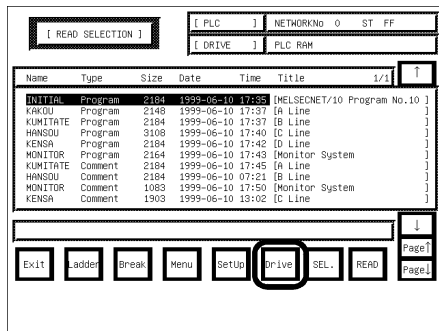

5) Then, touch the **Drive** key to select the drive (applicable memory) which stores the applicable ladder data to be monitored.

To the following page



From the previous page

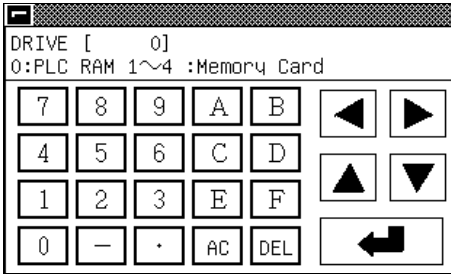

6) The Drive Selection Window is displayed. Select the drive (applicable memory) with the following keys.

- to  : Input the drive number.
- 0 (internal RAM)
- 1 - 4 (memory card)

: Clear all input data on the drive.

: Define the input.

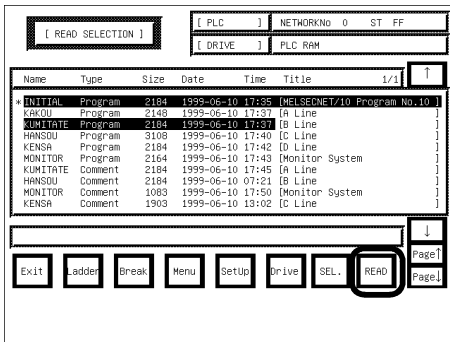

7) The file list of the selected drive is displayed. Select the ladder to be read with the following keys.

: Move the cursor upward.

: Move the cursor downward.

: Display the previous page.

: Display the next page.

: Move the cursor and touch the key to change select (\*)/cancel.

: Start reading the selected ladder.

**POINT**

When a keyword is registered at the PLC CPU, a key window is displayed at the start of reading. Input the keyword. (It does not have to be input if it is not registered.)

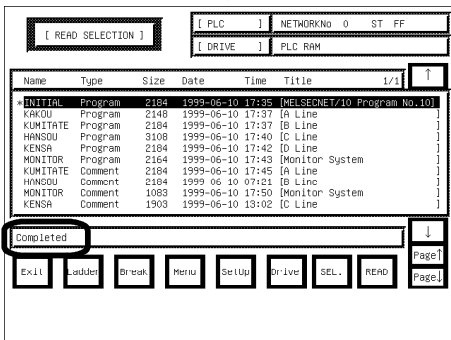

8) Contents and capacity of the reading process are displayed.

Touch  to stop the reading process.

To read the ladder again, start from the beginning.

9) When the message "Completed" is displayed, reading is completed. Change the screen with the following keys.

: Move to the screen when the ladder monitor is started.

: Move to the ladder monitor screen.

: Start from setting window (2) for the network No./station No.

**POINT**

Once PLC reading is performed, operations for PLC reading are not required from the next time onward.

6.1.2 Ladder read operation

This section describes the object sequence program of the ladder monitor that is read from the PLC CPU, for the operation displayed on the ladder monitor screen.

[Operation procedure]

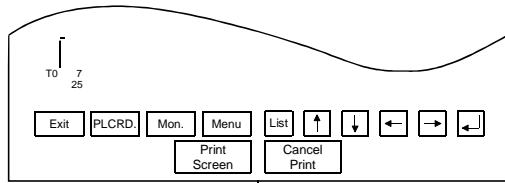

\* When there is a  at the upper left of the screen, touch it to return to the original screen.

MENU (Touch)

When the screen below is currently displayed, it is not necessary to touch this.

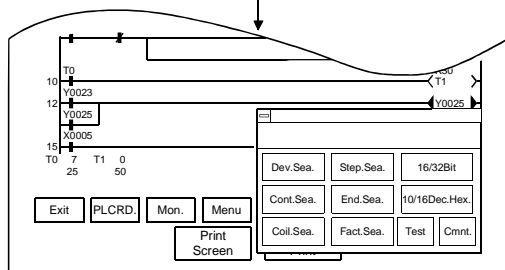

The ladder read operation is executed.

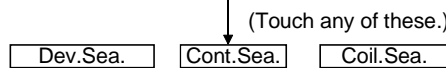

When specifying and reading the device, contact point or coil used in the program (\*4)

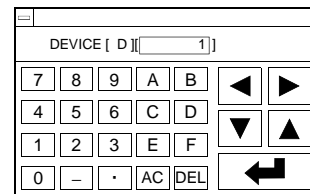
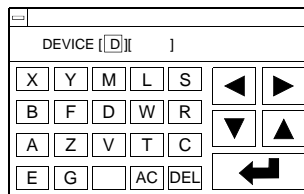

(When entering device name)

(When entering device No.)



  : Select input area.  
Alphanumeric: Enter device name and device No. (\*1)

1)



Move to ladder monitor screen (\*2)

(Touch: Input confirmation)

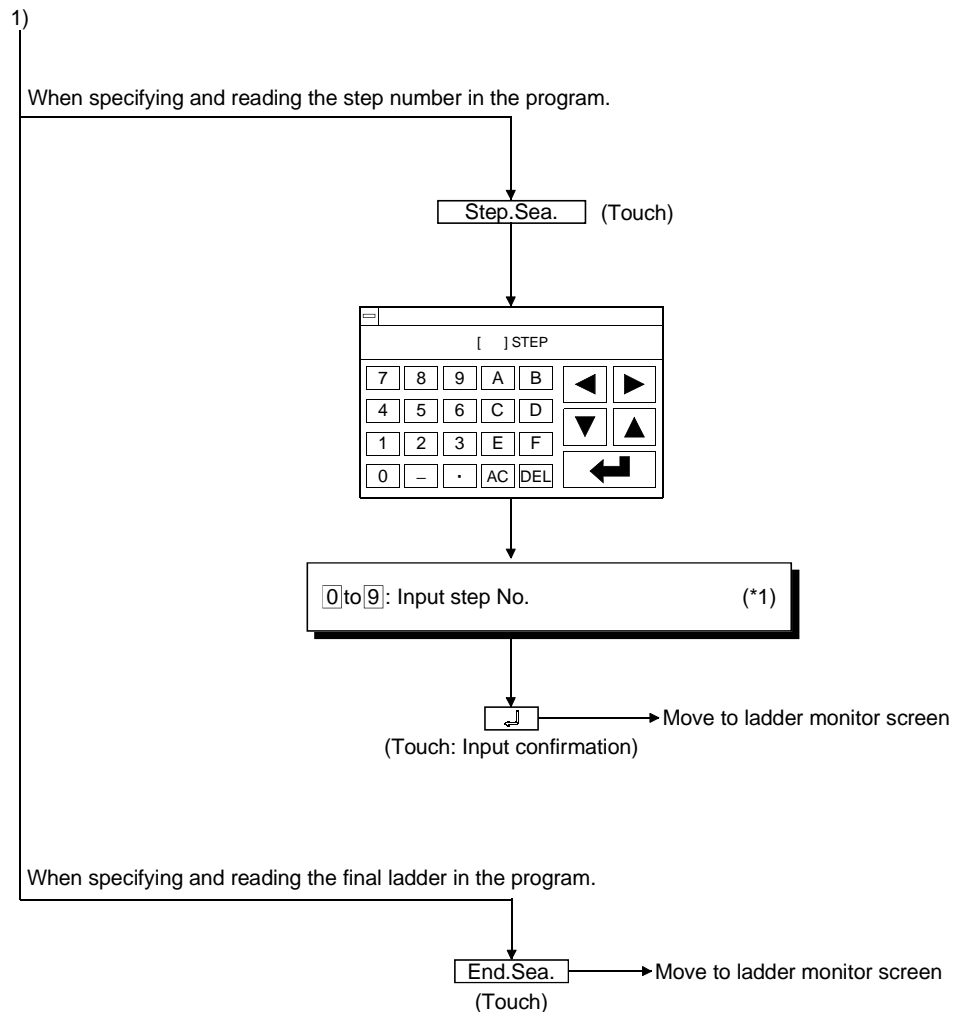

\*1 Data being entered can be cleared by the following keys.

**AC** : Clears all data being entered to the target area.

**DEL** : Clears one character at the cursor position.

\*2 When specifying and reading a device, contact point or coil used in the program, the search targets all programs starting from the step number displayed on the previous ladder monitor screen, to the program immediately previous to the one displayed.

After moving to the screen monitor screen, continuous reading by the same device is enabled by touching on the screen.

If you touch any other key but , the continuous read function is canceled.

\*3 When device search, contact point search, or coil search is performed during ladder monitoring, only the ladder block which includes the read search device is displayed.

Example) 1) When the device name to be searched is entered as "X0001"

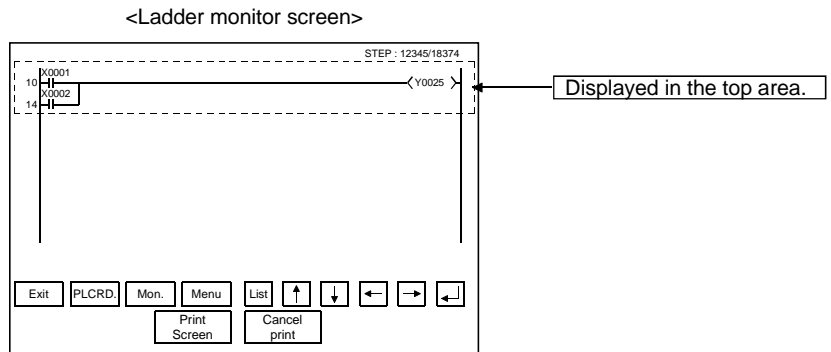

2) When the same search is repeated

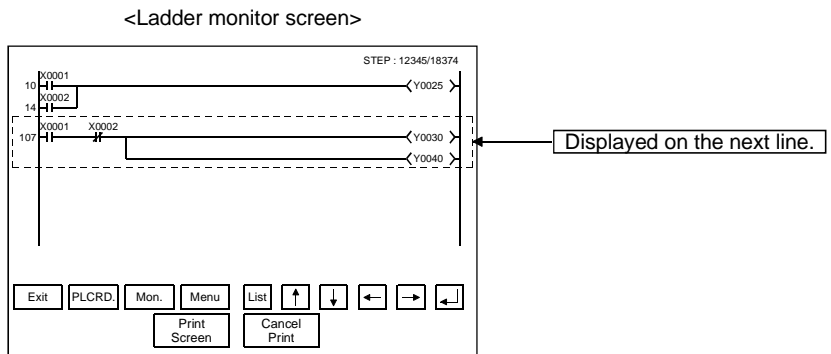

\*4 Please note that the indirect specification device (index register (z)) cannot be specified and read while the MELSEC-QnA ladder monitor is executed.

6.1.3 Using the defect search

The defect search enables you to examine an ladder block that caused a failure. It helps you to search from the ladder block backward so that you can determine why any coil was turned ON or OFF during the ladder monitoring, or whether its contact is conductive or nonconductive.

**POINT**

While the MELSEC-QnA ladder monitor is performed, the factor search function cannot be used.  
(The touch key of **Fact.Sea.** is not displayed.)

[Operation procedure]

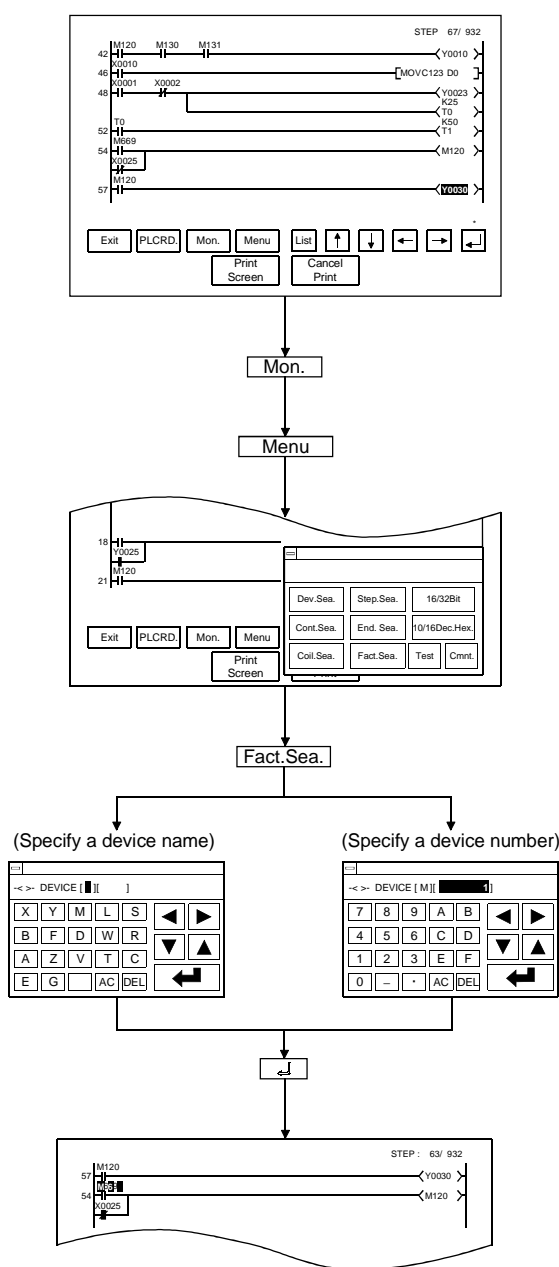

(1) Search for and display a ladder block where a failure occurred.

Example: When a valve connected to Coil Y0030 does not operate properly, begin searching for Coil Y0030 and view its ladder block on the screen.

(2) Touch **Mon.** to start the ladder monitoring.

(3) Touch **Menu** and then select **Fact.Sea.** from among options that appear on-screen.

If you touch **Fact.Sea.** without executing the ladder monitor function, a message appears on-screen, telling that "No MONITORING."

(4) Another dialog box where you can specify a device name or device number is displayed on-screen. Specify any contact of which coil is not turned ON as a search device. Example: Specify "M120" as the search device.

◀ ▶ : Used to select a data entry field.  
 Alphanumeric : Used to enter a device name or device number. \*1  
 ☐ : Used to stop the defect search, returning to the ladder monitor screen.

\*1 Use the following touch keys if you want to delete any data entry:

**AC** : Clears all the data entered in a specific field.  
**DEL** : Clears one character at the cursor position.

(5) Start searching for a device that caused a failure and view search results on the ladder monitor screen. Search from the last step number backward as displayed on the ladder monitor screen.

Please note that any touch keys other than **Esc** and **Exit** are enabled until the defect search is completed.

[Search results]

Search results reveal any occurrences of the search device. They are useful when you determine whether a defective device is conductive or nonconductive.

If any occurrence of the search device is not found as a result of the search, a message appears on-screen, telling that "PROGRAM NOT FOUND."

(1) When an occurrence of the search device is found:

If an occurrence of the search device is found as a result of the search, the search for another defective device will automatically be started.

Example: After searching for Device M120 that is in the OFF state, "M669" will be displayed as a device that caused a failure.

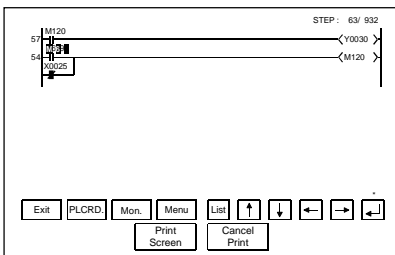

(This automatically begins searching for the defect that caused M669 to be turned OFF.)

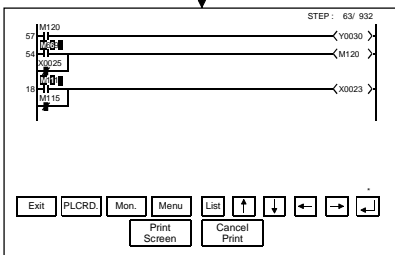

(This automatically begins searching for the defect that caused M111 to be turned OFF.)

A search for another defect is repeated.

After searching for Coil M120 that is in the OFF state, "M669" is displayed as a device that is not conductive.

Example: **M669**

\* After searching for a device that is in the ON state, a device that is conductive is displayed. The entire field of the device name and number is highlighted on-screen.

Example: **M669**

After searching for Coil M669 that is in the OFF state, "M111" is displayed as a device that is not conductive.

Example: **M111**

## (2) When two occurrences of the search device are found.

If two occurrences of the search device are found as a result of the search, the search will be completed and a message appears, telling that "the defect search is interrupted."

Example: After searching for Device M120 that is in the OFF state, "M669" and "X0025" will be displayed as devices that caused a failure.

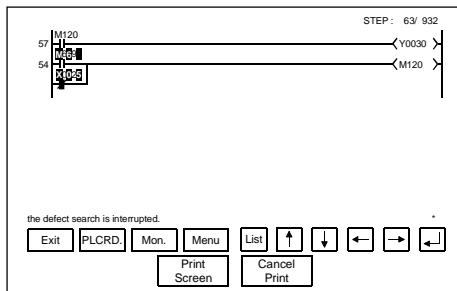

After searching for Coil M120 that is in the OFF state, "M669" and "X0025" are displayed as devices that are not conductive.

Example: **M669**, **X0025**

\* After searching for a device that is in the ON state, devices that are conductive are displayed. The entire field of the device name and number is highlighted on-screen.

Example: **M669**, **X0025**

**MENU** \*

\* To restart the defect search, touch **Menu** and then select **Fact.Sea.** from among options that appears on-screen.

Select either of Contact M669 or X0025 and start the defect search again.

## (3) To use the defect search, follow the instructions described below.

(a) If a B-contact is found defective as a result of the defect search, a search for the cause of the ON/OFF state will be automatically switched.

(b) The monitoring of device data will be restarted after the defect search is completed.

(c) Whether an A/B contact is conductive or nonconductive may not match its screen display during and after the defect search. This is because the monitoring is continued during the defect search.

(d) After the defect search is completed, touching **↑** or **↓** will allow you to search from the ladder backward in the search results display mode. Up to 100 ladders can be displayed on-screen. The following messages will appear at the start or the end of the search results.

- When viewing the start of search results: "This is the start of search results."
- When viewing the end of the search results: "This is the end of search results."

The ON/OFF display of contacts and coils on one screen is limited to 11 contacts per 1 coil per 1 ladder. If there are several coils available, the ON/OFF display of coils appears on-screen only for the device searched. If the steps of search results are related to 100 ladders or more, the ON/OFF display does not appear on-screen.

(e) **Menu** is replaced with **Esc** upon starting the defect search. Touching **Esc** can exit the search results display mode. Touching **Esc** again will replace it with **Menu**. When returning to the ladder mode, the last step of search results is displayed in the top of the screen.

(f) If on-screen data exceeds one screenful of data, it will be displayed across automatically scrolled screens.

(g) Touching **Esc** can stop the defect search. Search results are continuously displayed on-screen until **Esc** is touched. The ON/OFF display of the last-searched ladder does not appear on-screen.

6.1.4 Changing from one screen to another

This section describes the screen movements when executing the ladder monitor from the status where the user-created monitor screen is displayed.

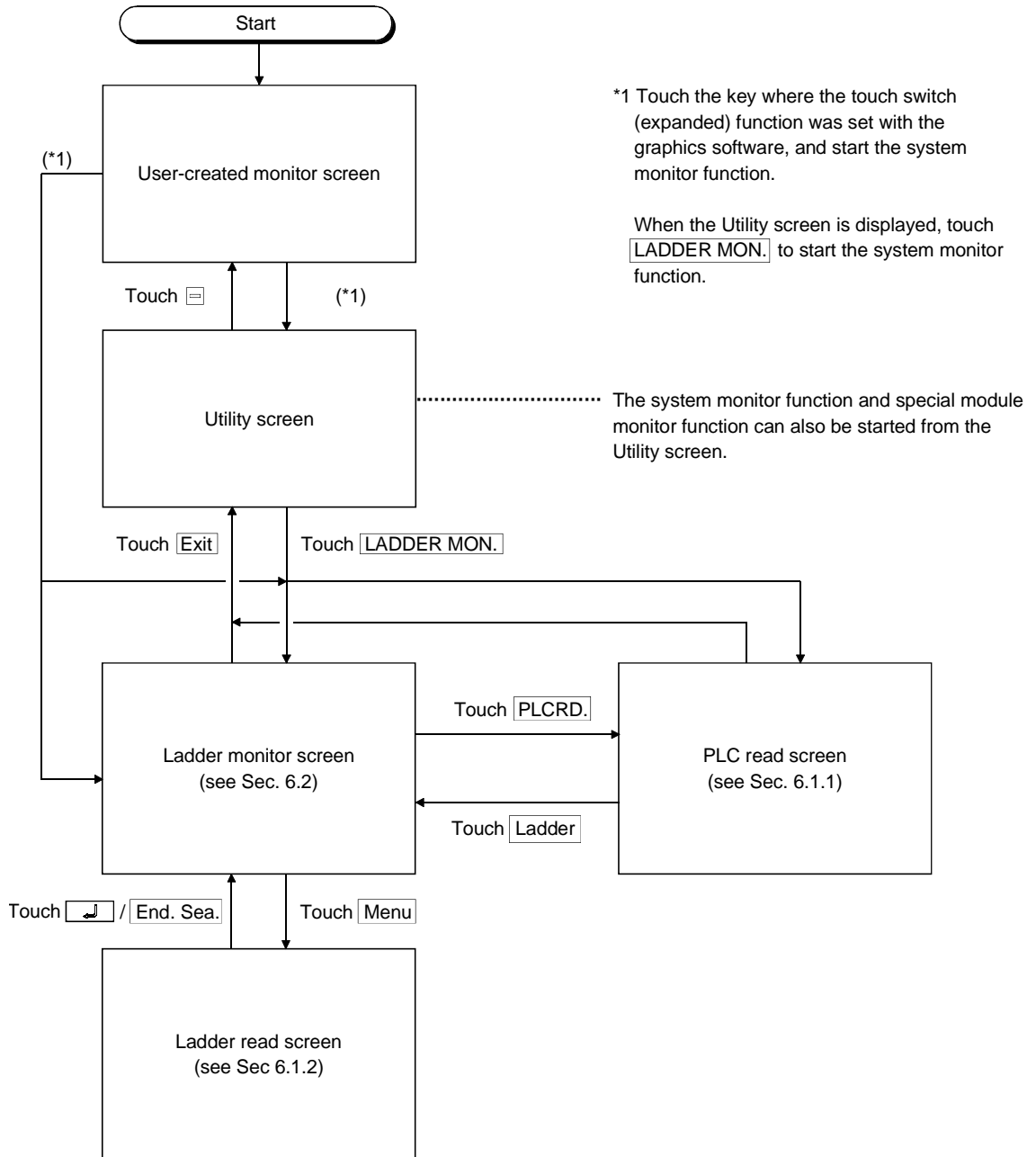



6.2 Ladder monitor

The ladder monitor screen display and the keys that are shown at the top of the screen are explained in this section.

6.2.1 Ladder monitor screen display and key functions

The ladder monitor screen varies depending on the type of PLC CPU to be monitored.

(1) When MELSEC-A/FX ladder monitor is executed

(a) Display

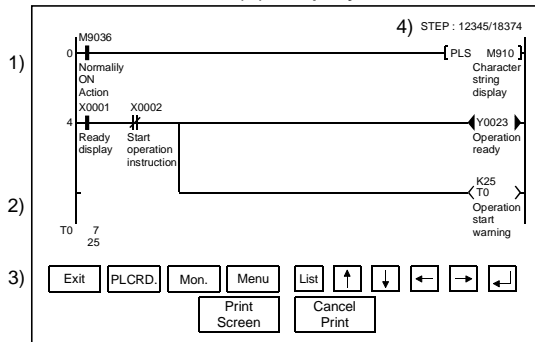

When comment is not displayed : maximum 8 lines  
 When comment is displayed : maximum 3 lines

ON/OFF status display for ladder monitor

- ON status
- OFF status

\* The MCR command is normally displayed as

1)	Sequence program is displayed. A maximum of 11 contact points is displayed in one line of a ladder; for 12 contact points or more, move to the next line. When a comment display is specified, a comment is also displayed; expanded comments are given priority (For the method of displaying comments, see Sec. 6.2.3.).
2)	A maximum of eight devices is displayed for the word device current value, timer and counter current value (upper row), and set value (lower row). When the set value is an indirect specification, the value of the indirectly specified device is displayed. (To switch between decimal and hexadecimal for the displayed value, see Sec. 6.2.3.).
3)	Display the keys used with the operation on the ladder monitor screen shown in (b) (Touch input).
4)	The display step number (left) and the remaining step number (right) are displayed.

(b) Key functions

This table shows the key functions used with the operations on the ladder monitor screen.

Key	Function
	Return to screen where ladder monitor function starts.
	Move to PLC read screen to read sequence program being monitored from PLC CPU (PLC read).
	Move to ladder monitor menu screen, to specify sequence program to be displayed on ladder monitor screen (Ladder read).
	Start monitoring of sequence program that is displayed on ladder monitor screen.
	Activates the List editor function. (For details of the List editor function, see Chapter 19.)
	Switch display device when there are nine or more devices displaying current values and set values.
	Display one ladder; scroll up or down.
	When reading ladder with device specification, read next program with same device specification (see *2 in Sec. 6.1.2.).

**POINT**  
 After executing PLC read, if the PLC CPU comment or comment capacity is changed, the comment may not be correctly displayed on the ladder monitor screen.  
 When changing the comment or comment capacity, re-start the GOT.

(2) When MELSEC-QnA ladder monitor is executed

(a) Display

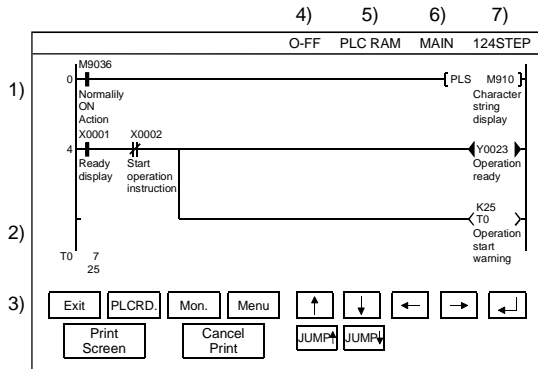

When comment is not displayed : maximum 8 lines

When comment is displayed : maximum 3 lines

ON/OFF status display for ladder monitor

- ON status
- OFF status

\* The MCR command is normally displayed as

1)	Sequence program is displayed. A maximum of 11 contact points is displayed in one line of a ladder; for 12 contact points or more, move to the next line. When a comment display is specified, a comment is also displayed; expanded comments are given priority (For the method of displaying comments, see Sec. 6.2.3.).
2)	A maximum of eight devices is displayed for the word device current value, timer and counter current value (upper row), and set value (lower row). When the set value is an indirect specification, the value of the indirectly specified device is displayed. (To switch between decimal and hexadecimal for the displayed value, see Sec. 6.2.3.).
3)	Display the keys used with the operation on the ladder monitor screen shown in (b) (Touch input).
4)	The network No. and the station No. are displayed.
5)	The drive is displayed.
6)	The file name of the PLC program is displayed.
7)	The total number of steps in the current monitor PLC program is displayed.

(b) Key functions

This table shows the key functions used with the operations on the ladder monitor screen.

Key	Function
	Return to screen where ladder monitor function starts.
	Move to PLC read screen to read sequence program being monitored from PLC CPU (PLC read).
	Move to ladder monitor menu screen, to specify sequence program to be displayed on ladder monitor screen (Ladder read).
	Start monitoring of sequence program that is displayed on ladder monitor screen.
	Switch display device when there are nine or more devices displaying current values and set values.
	Display one ladder; scroll up or down.
	When reading ladder with device specification, read next program with same device specification (see *2 in Sec. 6.1.2.).
	Scrolls the display up or down by ten ladders.

<b>POINT</b>	After executing PLC read, if the PLC CPU comment or comment capacity is changed, the comment may not be correctly displayed on the ladder monitor screen. When changing the comment or comment capacity, re-start the GOT.
--------------	---

6.2.2 Precaution during ladder monitoring

(1) When making connection to the FXCPU

- (a) The comment display is kana comments only.
- (b) During PLC read operation, the PLC read can only be performed for own station only.
- (c) STL (step ladder), the FXCPU exclusive instruction, is not a contact point, but treated as an instruction and displayed in the following manner:

When monitoring with the peripheral device for FX

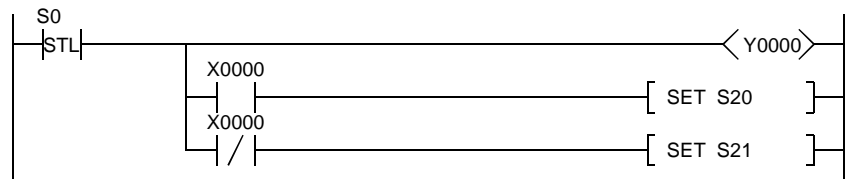

When ladder monitoring with GOT

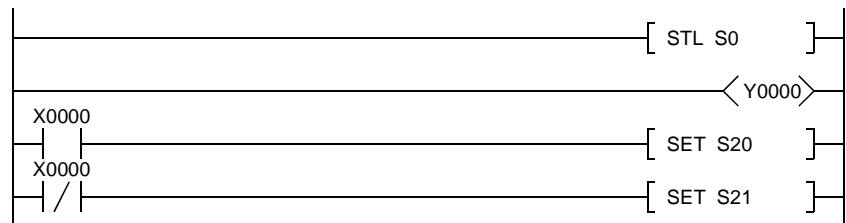

- (d) When searching for STL instruction, search for "S (state)" in the device search.

(2) When making connection with the motion controller CPU

- (a) When the OS version is "SV5\*\*" in the SVST instruction, "J\*\*" appears as the tag name of MC.

6.2.3 Switching the display form (decimal/hexadecimal) and turning the comment display on/off

You can switch the display form (decimal/hexadecimal) of the word device value or the timer/counter value that is displayed on the ladder monitor screen. You can also specify whether or not to display a comment for the object device.

1) Switching the display form (decimal/hexadecimal)

When monitoring, display the word device current value, the timer/counter current value (upper row) or the set value (lower row) in decimal or hexadecimal (When decimal is displayed, the display changes to hexadecimal.).

2) Switching the comment display on and off

Display the comment that is written in the object PLC CPU (When no comment is displayed, this turns on the comment display). Comment display priority order: expanded comment > Japanese character comment or Japanese kana comment

The display change operation is explained below.

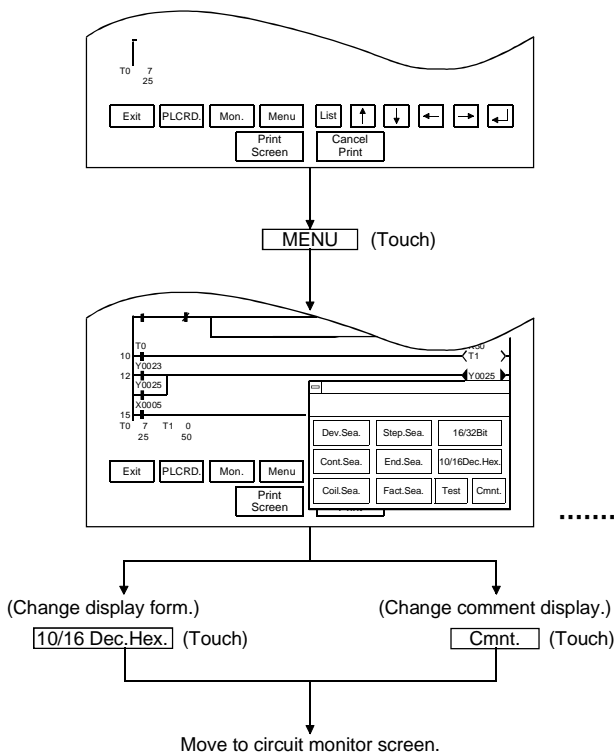

[Operation procedure]



\* When there is a  at the upper left of the screen, touch it to return to the original screen.

When the screen below is currently displayed, it is not necessary to touch this.

Touch the appropriate display position on the ladder monitor menu.

..... After moving to the ladder monitor screen, the word device value is  when you touch .

(When changing to hexadecimal display)

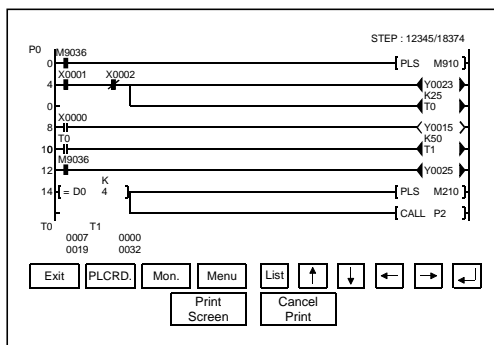

(When changing to comment display)

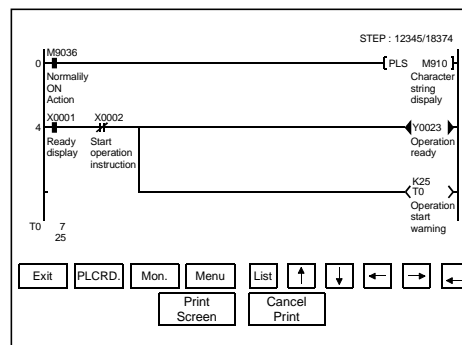

6.2.4 Changing the device value

**CAUTION**

- Read the manual carefully and fully understand the operation before the test operation (ON/OFF of bit devices, modifying current value of a word device, modifying timer/counter setting, modifying the current value, or modifying the current value of a buffer memory) of ladder monitor.
- In addition, never modify data in a test operation to a device, which performs a crucial operation to the system.
- It may cause an accident by a false output or malfunction.

Changing the device value on the screen during ladder monitoring is described. Switches for the timer/counter value display format (decimal/hexadecimal), and the comment display for the corresponding device (on/off) can be performed.

(1) Device value changing method

The device value changing method during ladder monitoring is described below:

<Circuit monitor Screen>

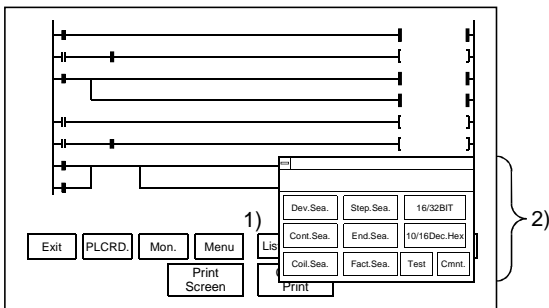

Display the ladder monitor screen by touching **LADDER MON.**

- 1) Display the screen shown in 2) by touching **Menu**.
- 2) Display the test window by touching **Test**.

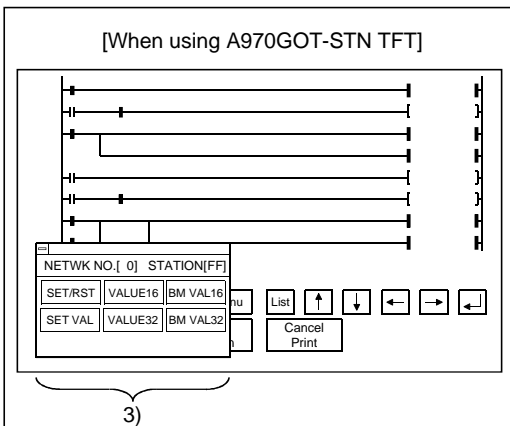

- 3) As the test window will open, perform the operation by seeing Sec. 9.6.

After the device change is complete, the changed contents can be verified in the ladder monitor.

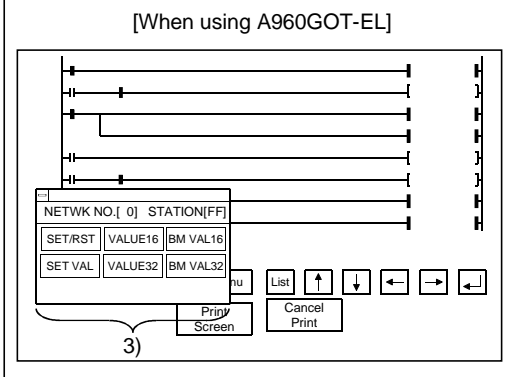

**NOTE**

The current value display of the word device becomes hidden from view due to the test window. Using the **→** **←** key entries, the hidden current value display can be displayed by scrolling to the right/left.

6.2.5 Printing

Printing out during ladder monitoring is described.

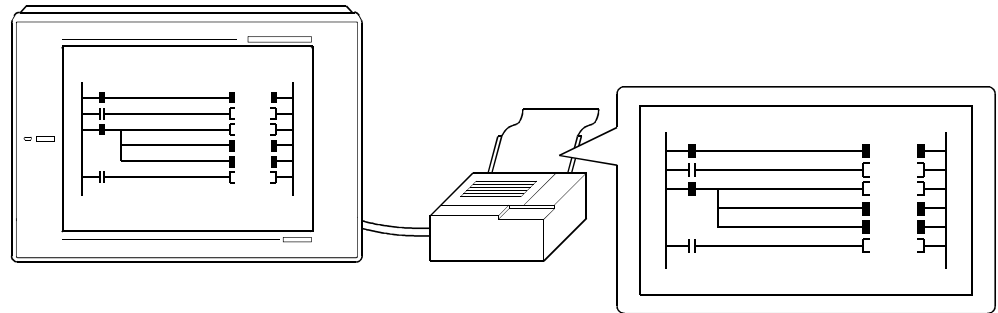

- When performing printouts of the ladder monitor screen, always install the option driver to GOT.
- A printout on paper of a ladder monitor screen can be generated for the TFT-STN type screen display.  
For the EL type screen display, no printout can be produced.

(1) Printout method during ladder monitoring

The printout method during ladder monitoring is described below:

<Ladder monitor screen>

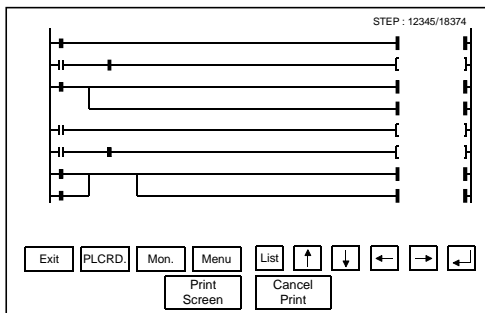

Display the ladder monitor screen by touching **LADDER MON.**

- 1) Execute the printout by touching **Print Screen**.
- 2) To cancel the printout, touch **Cancel Print**.



## Chapter7 Error display and handling with ladder monitoring

The following chart shows the error messages that are displayed during the ladder monitor operation and the method of handling them.

Error Message	Description	Method of Handling
ENTRY CODE MISMATCH	The specified keyword is different from the keyword that is registered in the object PLC CPU.	Check the keyword that is registered in the object PLC CPU and specify again.
FILE NOT FOUND	(1) An attempt was made to switch to the ladder monitor screen when a sequence program had not been read. (2) When the file is selected and the <b>Read</b> key is pressed, the selected file does not exist in the PLC drive.	Read the sequence program that is written in the object PLC CPU. (Ex.) A sub-sequence program can only be specified as A3 [ ] CPU/A4UCPU.
PLC COMMUNICATION ERROR	(1) Cannot communicate with PLC CPU of the specified network No. or station No. (2) The specified drive does not exist.	Check and correct the following: (1) Does the specified PLC CPU exist? (2) Is it online? (Data communication status?) (3) Has an error occurred?
LOCK ON OTHER MACHINE. PLEASE CANCEL	File is locked with the peripheral equipment (GPPW, GPPQ).	After reading and writing with the peripheral equipment (GPPW, GPPQ), read the file again.
NOT EXISTING DRIVE, DRIVE ERROR	(1) The specified drive does not exist. (2) The specified drive is faulty.	(1) Check whether the specified drive exists or not. (2) Check whether the specified drive is faulty or not.





## Chapter8 Operation procedures for the system monitor function

The operation procedures for using the system monitor function are explained in this section.

### 8.1 Operation procedures before starting system monitoring

This section contains a summary of the procedure for transmitting the system program (OS) for the system monitor function from the Personal computer to the GOT until it is installed in the built-in memory.

For details, please refer to the Help in the drawing software. Details of the screen display and key operation are shown in the Help.

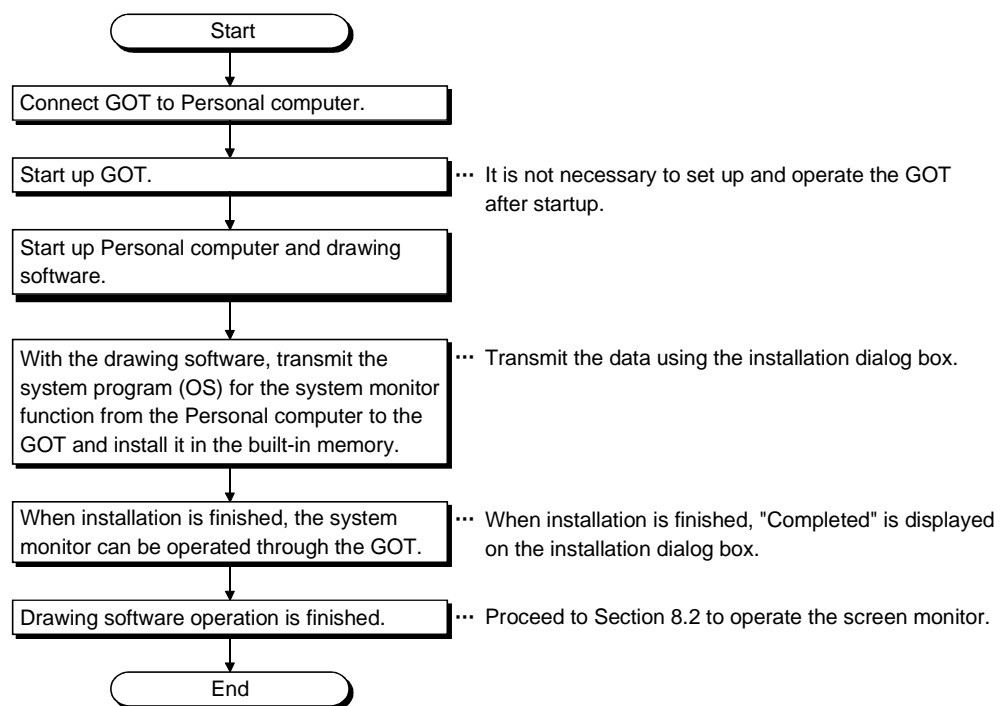

8.2 Operation procedures from user-created monitor screen display to start of system monitoring

This section explains the operation procedure for the GOT when starting each operation of the system monitor function, after the system program (OS) of the system monitor function has been installed in the GOT built-in memory.

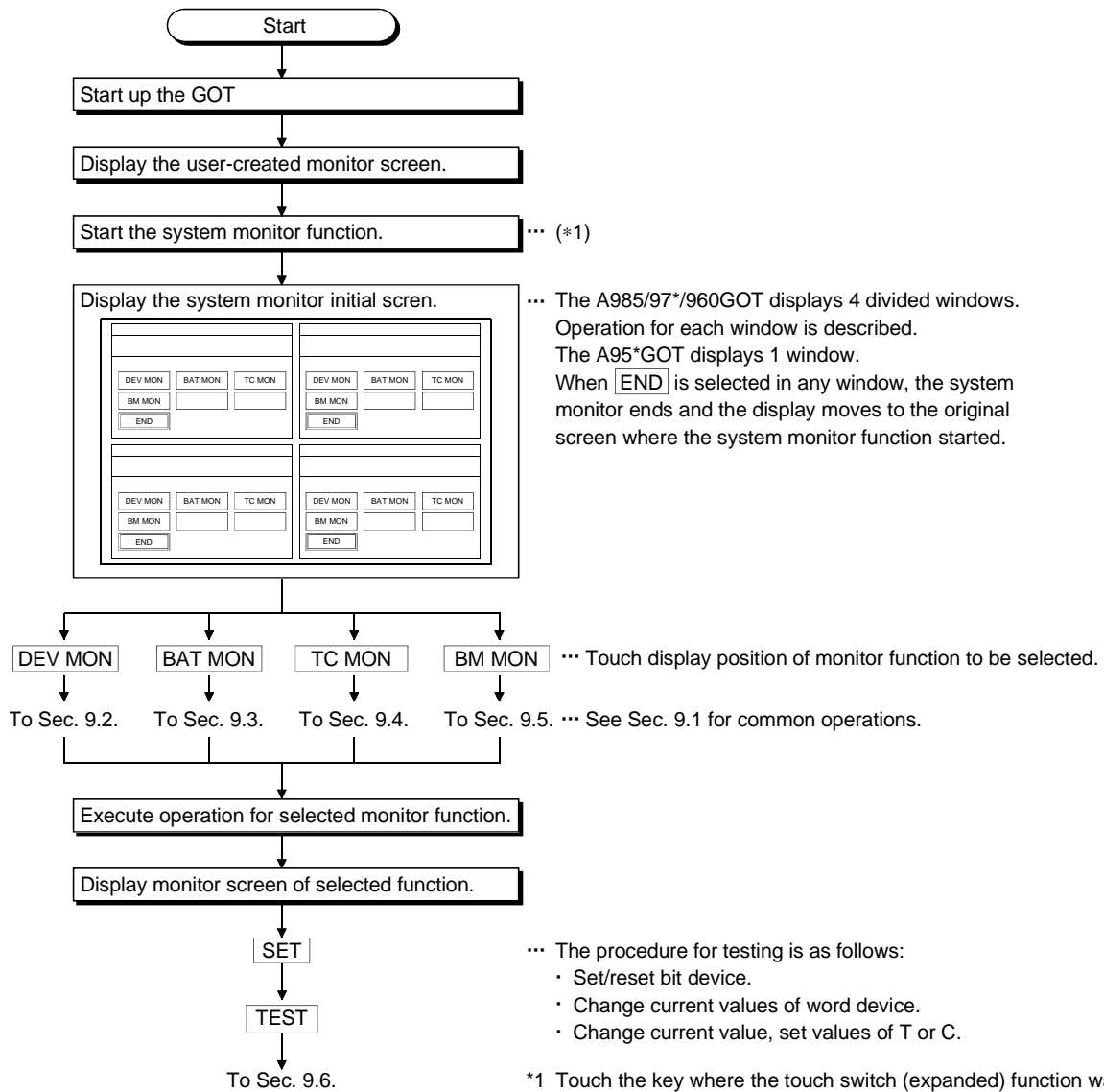

Chapter9 Operation of the various system monitor screens

This chapter contains an explanation of each screen operation when using the system monitor function.

POINT	With any of the four windows, when changing the station/monitor device or executing the test operation, it is not possible to do an operation with another window until that series of operations is finished.
-------	--

9.1 Screen configuration, common operations and changing screens when monitoring

The common operations of each monitor function such as screen configuration and target PLC CPU specification when executing system monitoring are described below.

9.1.1 Basic screen configuration and key functions (menu)

The basic screen configuration displayed in the windows and the key functions displayed on the screen are shown below.

(1) Display

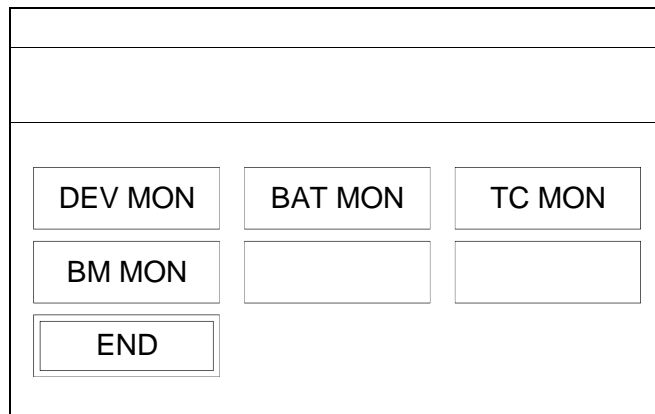

(2) Key functions

The functions of keys that are used with the basic screen operation are shown in the chart below.

Key	Function
DEV MON	The entry monitor is executed with the applicable window (see Sec. 9.2.).
BAD MON	The batch monitor is executed with the applicable window (see Sec. 9.3.).
TC MON	The timer/counter monitor is executed with the applicable window (see Sec. 9.4.).
BM MON	The buffer memory monitor is executed with the applicable window (see Sec. 9.5.).
END	System monitoring ends; display returns to the screen where system monitors function started.

9.1.2 Switching the display form (decimal/hexadecimal) and turning the comment display on/off (FORM)

(1) Switching the display form (decimal/hexadecimal)

Display the word device present value or the timer/counter present value or set value in decimal or hexadecimal.

(2) Switching the comment display on and off

Display the comment that is written in the object PLC CPU (Comment display priority order: expanded comment > Japanese character comment or Japanese kana comment).

(When changing to hexadecimal display)

DEVICE MONITOR	TEST	MENU	FORM	SET
NETWK No.[ 0] STATION[FF]				
D	15	H	80000000	
D	10	H	8001	
X	001	●		
M	25	○		
Y	70	●		
W	200	H	002B	
R	50	H	04135	
C	200	H	7000	

(When changing to comment display)

DEVICE MONITOR	TEST	MENU	FORM	SET
NETWK No.[ 0] STATION[FF]				
D	200		50	▲
			[Production line A ]	
W	200		43	
			[Production quantity ]	
R	50		68378428 DW	
			[link status ]	
X	10		100	▼
			[Production line B ]	

When the monitoring destination is being operated with the following conditions using the QnA series CPU, take note that the comment display cannot be performed.

<Conditions>

When executing multiple programs, multiple comment files exist, and all comment files are set as "same file name being used as program."

When performing the comment display, use the comment file with a set specification.

Below is an explanation of the operation for changing the display, using the Entry Monitor window as an example.

The operation procedure is the same for changing the display when selecting windows other than Entry Monitor.

[Operation procedure]

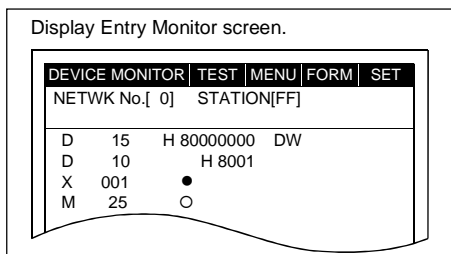

When you touch **MENU** you return to the basic screen.

When you touch **SET**, the monitor station and device ).....can be specified. (See Sec. 9.1.3)

When you touch **FORM**, you can change this display.

The selected **FORM** display is also found on the screen displayed after selecting the monitor function with the basic screen and on each menu screen, in addition to each monitor screen.

**FORM** (Touch)

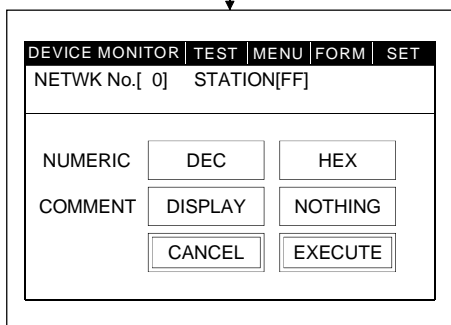

).....Display monitor station network no. and station

\* When you touch **CANCEL**, the display change is interrupted and the display returns to the monitor screen.

(Change display form.)

(Change comment display)

**DEC** **HEX**

**YES** **NO**

(1) Touch the display position of the selected menu.

**EXECUTE** (Touch)

(Return)  
Monitor screen

<b>POINT</b>
<p>After starting the system monitor, if the PLC CPU comment or comment capacity is changed, the comment may not be correctly displayed on each monitor screen.</p> <p>When changing the comment or comment capacity, re-start the GOT.</p>



9.1.3 Specifying the monitor station and device (SET)

An explanation of the procedure for specifying the monitor station and the device for executing the system monitor is explained below, using the Entry Monitor window as example.

The operation procedure is the same for specifying the monitor station and device when selecting windows other than Entry Monitor.

\* When there is a  (keywindow), touching it to returns to the monitor screen.

[Operation procedure]

Select monitor function with basic screen.  
Or, display  monitor screen or  menu screen.

.....See Sec. 9.1.1.

.....See the explanatory section for each monitor screen and the menu screen.

DEVICE MONITOR		TEST	MENU	FORM	SET
NETWK No.[ 0]		STATION[FF]			
D	15	-2147483648	DW		
D	10	-32767			
X	001	●			
M	25	○			
T	30		100	200	↑↓ ○
W	200		43		
R	50	68378428	DW		
C	5	300	300	■ ●	

.....When you touch **MENU** you return to the basic screen.  
When you touch **FORM**, you change this display. (See Sec. 9.1.2.)

When you touch **SET**, you can specify the monitor station and device.

**SET** (Touch)

DEVICE MONITOR		MENU	FORM	SET
NETWK No.[ 0]		STATION[FF]		
ENTRY	DELETE	ALL CLR		
TEST				
CANCEL				

**ENTRY** (Touch)

1)

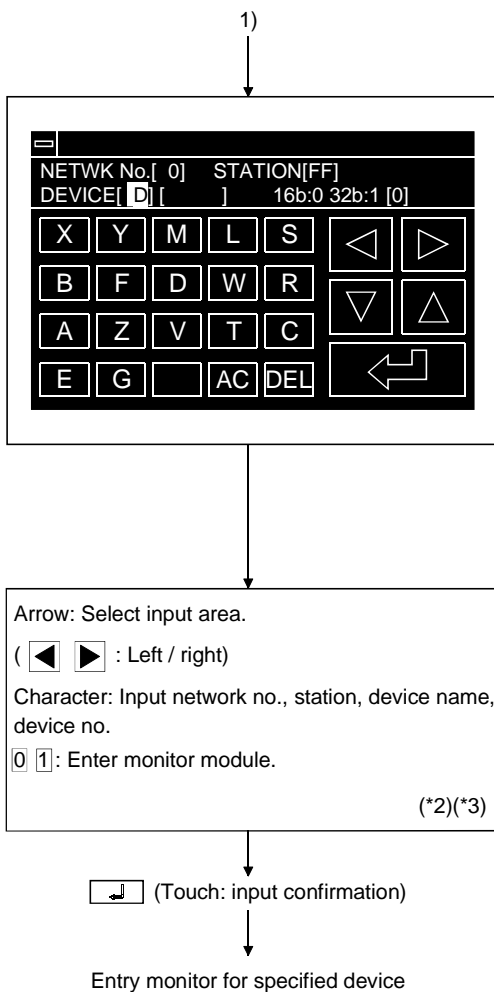

1) Specify network No. and station No. of object PLC CPU.

(\*1)

(For data link system)

NET WK No.: 0  
STATION : FF (Host station)  
0 (Master station)  
1 to 64 (Local station)

(For network system)

NET WK No.: 0 (Host loop)  
1 to 255 (Specified loop)  
STATION : FF (Host station)  
0 (Control station)  
1 to 64 (Normal station)

(2) Specify the device to be monitored.

(3) When specifying the word device or buffer memory as

a monitor device, specify the monitor module.

0: 16-bit (1-word) module  
1: 32-bit (2-word) module

\* Match the data to be entered; the touch key display at the bottom of the screen will change.

(EX.)

(When entering network no.)

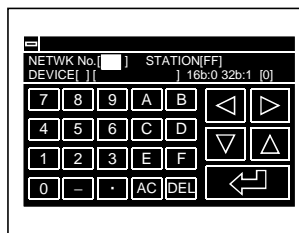

(When entering device no.)

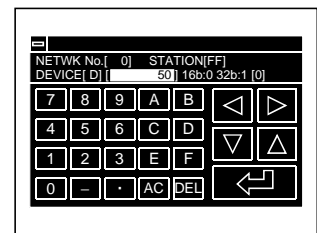

\*1 For the station, with either system, specify "FF", which shows the PLC CPU to be accessed, or "0" to "64".

\*2 Data being entered can be cleared by the following keys.

AC : Clears all data being entered to the target area.

DEL : Clears one character at the cursor position.

\*3 The form of data to be entered is displayed at the right side of the screen.

DEC : Enter in decimal

HEX : Enter in hexadecimal



9.1.4 Changing screens

This section shows the screen changes when executing each monitoring operation of the system monitor function from the status where the user-created monitor screen is displayed.

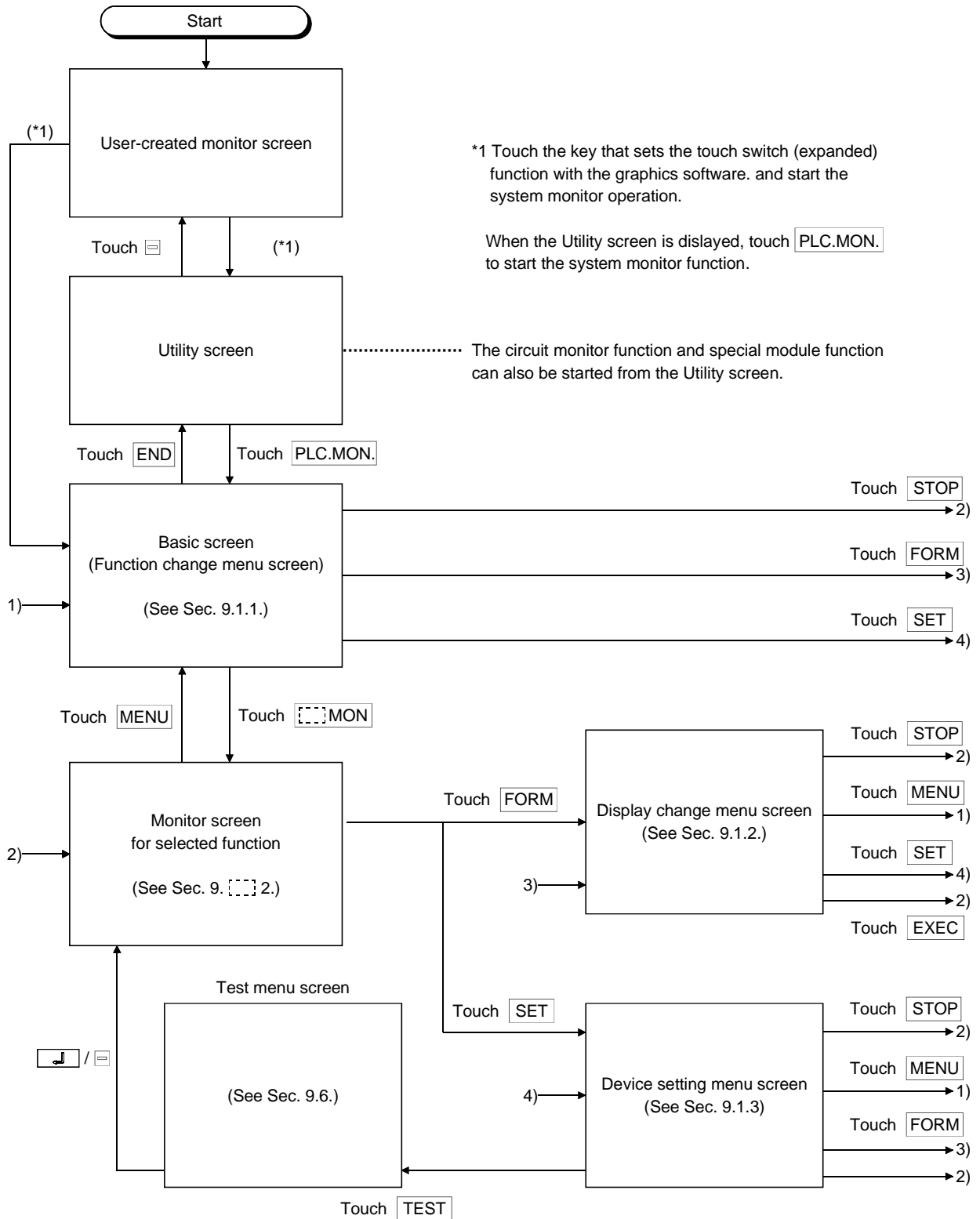

9.2 Entry monitor

Enter the device to be monitored in advance. The function that monitors only the device that was entered is called the "entry monitor".

The entry monitor operation when executing the system monitor function is explained below.

9.2.1 Basic operation

The entry monitor operation procedure is shown below.

See Sec. 9.1.1.

[Operation procedure]

Select "Device Monitor" with the basic screen.

.....When a screen other than the basic screen is displayed, touch **MENU** at the top of the currently displayed screen, display the basic screen, and select Device Monitor.

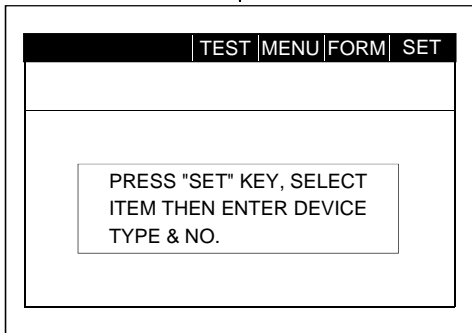

.....When you touch **MENU**, you return to the basic screen. When you touch **FORM**, you can change this display (See Sec. 9.1.2.).

When you touch **SET**, you can specify the monitor station and device (See Sec. 9.1.3.).

(\*2)

Enter the monitor device. (\*1)

.....Set the station and device to be monitored. For the setting method, see Sec. 9.1.3.

When entry is complete, display the Device Monitor screen.

\*1 Monitor device entry is in station modules.

If you change the station for the monitor device, all monitor devices entered before that are invalid.

\*2 A maximum of 8 entry devices can be entered.

To enter more than 8, delete in order from the old entry device. The 8 most recent entry device will be monitored.

As needed, re-enter after deleting the entry device. (For the method of deletion, see Sec. 9.2.3.)

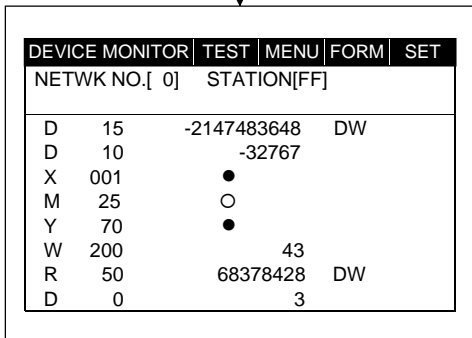

Change the screen display.

.....Do if needed.

For the display change method, see Sec. 9.1.2.

9.2.2 Entry monitor screen display and key functions

In this section, the Entry Monitor screen display and the functions of the keys displayed at the top of the screen are explained.

(1) Display

The screenshot shows the Entry Monitor screen with the following layout:

- Top bar: DEVICE MONITOR | TEST | MENU | FORM | SET
- Line 1: NETWK No.[ 0] STATION[FF]
- Line 2: D 200 30 [Line 1 current units] ▲
- Line 3: W 200 43 [Production line A ]
- Line 4: R 50 68378428 DW [link status ]
- Line 5: X 3 ● [Input switch 3 ] ▼

Annotations on the screenshot:

- 1) Points to the top bar keys.
- 2) Points to the network and station numbers.
- 3) Points to the device status and current value.

Legend:

- When comment is not displayed: max. 8 devices
- When comment is displayed : max. 4 devices
- Display when system monitoring
- Bit device .....●:ON ○: OFF
- Word device .....Current value

1)	Displays the keys that are used with the operation of the Entry Monitor screen shown in (2) (Touch input).
2)	Displays the monitor station network No. and station No.
3)	Displays the status and current value of the device.

(2) Key functions

The chart below shows the functions of the keys that are used with the Entry Monitor screen operation.



Key	Function
MENU	Move to basic screen (function change menu screen) to change to another monitor function or ending the system monitor (See Sec. 9.1.1.).
FORM	Move to the display change menu screen to change the numerical display on the Entry Monitor screen (decimal, hexadecimal) or changing the comment display (on/off) (See Sec. 9.1.2.).
SET	Move to device setting menu screen to enter the monitor device, delete the device, or execute a test. <ul style="list-style-type: none"> <li>• Entry of monitor device (See Sec. 9.1.3.)</li> <li>• Deletion of entry device (See Sec. 9.2.3.)</li> <li>• Test (See Sec. 9.6.)</li> </ul>
▲ ▼	Scroll the display up or down one line, and display the monitor device that is not displayed (just before or after the current display). When five or more monitor devices are entered, operation is enabled when the monitor device comment is displayed. ▼ : Scrolls down one line. ▲ : Scrolls up one line.

9.2.3 Deleting a registered device

The operation of deleting (erasing) the entry of the device being monitored with the Entry Monitor screen is explained below.

The following two methods can be used to delete the registered device.

- Random deletion ..... Deletes only one specified device.
- Batch deletion ..... Deletes all devices that are currently registered.

\* If there is a  at the upper left of the screen, touching the  returns to the monitor screen.

[Operation procedure]

Display Device Monitor screen. .... See Sec. 9.2.2.

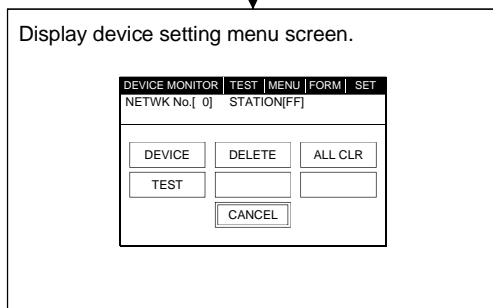

SET (Touch)

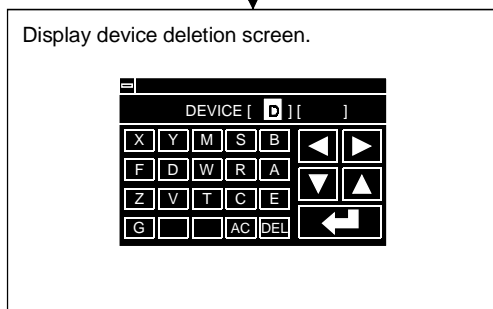

(Batch deletion) (Random deletion)  
 ALL CLR DELETE (Touch either key.)





▶ ◀ : Select input area  
 Character: Input device name and no. (\*1)

 Move (return) to Device Monitor screen.  
 (Touch: Input confirmation)

(1) Specify the device to be deleted.  
 \* Match the data to be entered; the touch key display at the bottom of the screen will change.

\*1 Data being entered can be cleared by the following keys.

-  : Clears all data being entered to the object area.
-  : Clears one character at the cursor position.

9.3 Batch monitor

When monitoring, the function of specifying the device at the beginning of an optional device range and monitoring it is called the "batch monitor".

The batch monitor operation when executing the system monitor is explained below.

9.3.1 Basic operation

The batch operation procedure is shown below.

See Sec. 9.1.1.

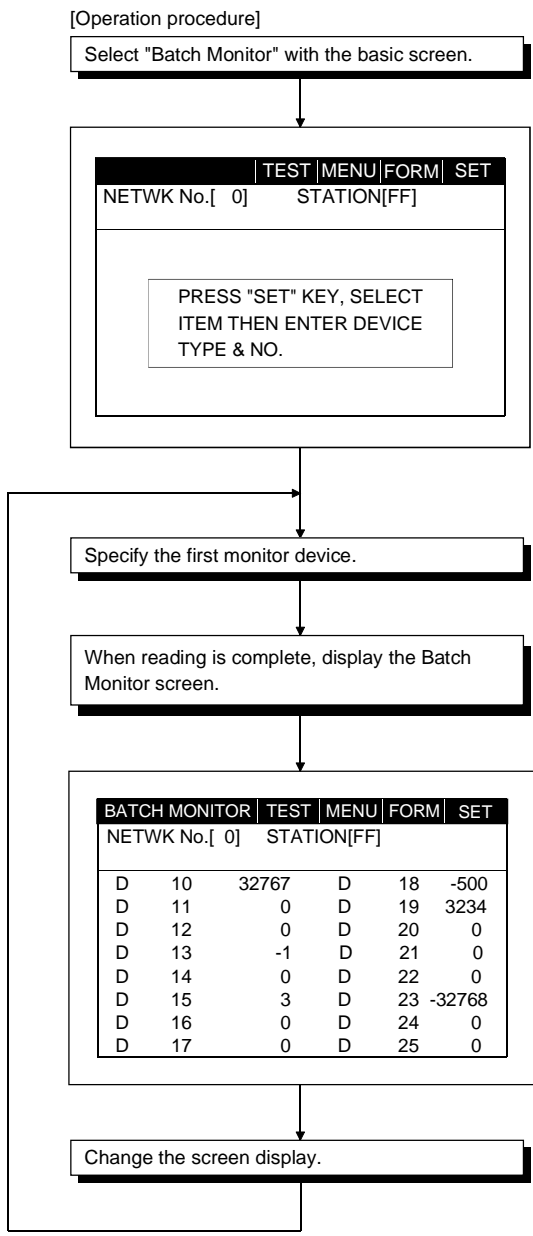

.....When a screen other than the basic screen is displayed, touch **MENU** at the top of the currently displayed screen, display the basic screen, and select "Batch monitor".

.....When you touch **MENU**, you return to the basic screen.

When you touch **FORM**, you can change this display (See Sec. 9.1.2.).

When you touch **SET**, the monitor station and device can be specified (See Sec. 9.1.3.)

- (1) Specify the station and device to be monitored. For the method of specifying, see Sec. 9.1.3.

.....Do if needed.

For the display change method, see Sec. 9.1.2.

9.3.2 Batch monitor screen display and key functions

In this section, the Batch Monitor screen display and the functions of keys displayed at the top of the screen are explained.

(1) Display

2) 

BATCH MONITOR	TEST	MENU	FORM	SET
NETWK No.[ 0]		STATION[FF]		
D 10	32767[			] ▲
D 11	0[Inventory quantity			]
D 12	0[Shipment quantity			]
D 13	-1[			]
D 14	0[Warehouse A temperature]			]
D 15	3[Warehouse B temperature]			]
D 16	0[			]
D 17	0[Production plan			] ▼

1)

When comment is not displayed: max. 16 devices  
 When comment is displayed : max. 8 devices  
 Display when system monitoring  
 ·Bit device .....● :ON ○ : OFF  
 ·Word device .....Current value

1)	Displays the keys that are used with the operation of the Batch Monitor screen shown in (2) (Touch input).
2)	Displays the monitor station network No. and station No.
3)	Displays the status and current value of the monitor device (The screen above shows when the monitor module is 16 bits.).

(2) Key functions

The chart below shows the functions of the keys that are used with the Batch Monitor screen operation.

Key	Function
MENU	Move to basic screen (function change menu screen) for changing to another monitor function or ending the system monitor (See Sec. 9.1.1.).
FORM	Move to display change menu screen for changing the numerical display on the Batch Monitor screen (decimal/hexadecimal) or changing the comment display (on/off) (See Sec. 9.1.2.).
SET	Move to device setting menu screen to change the monitor device or execute a test. <ul style="list-style-type: none"> <li>• Change of monitor device (See Sec. 9.1.3.)</li> <li>• Test (See Sec. 9.6.)</li> </ul>
▲ ▼	Scroll the display up or down one line, and display the monitor device that is not displayed (just before or after the current display). ▼ : Scrolls down one line. ▲ : Scrolls up one line.

9.4 TC Monitor (monitor of timer and counter)

The function that monitors only the time (T) and counter (c) when monitoring is called the TC monitor.

The TC monitor operation when executing the system monitor is explained below.

9.4.1 Basic operation

The TC operation procedure is shown below.

See Sec. 9.1.1.

[Operation procedure]

Select "TC Monitor" with the basic screen.

.....When a screen other than the basic screen is displayed, touch **MENU** at the top of the currently displayed screen, display the basic screen, and select "TC Monitor".

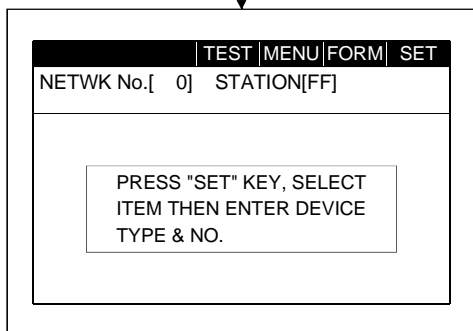

.....When you touch **MENU**, you return to the basic screen.

When you touch **FORM**, you can change this display (See Sec. 9.1.2.).

When you touch **SET**, the monitor station and device can be specified (See Sec. 9.1.3.).

Specify the initial monitor device.

(1) Specify the station and device to be monitored. For the method of the specifying, see Sec.9.1.3.

When reading is complete, display the TC Monitor screen.

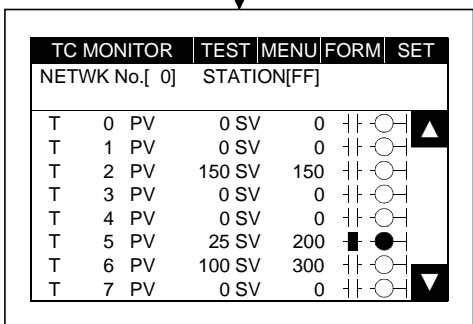

Change the screen display.

.....Do if needed.

For the display change method, see Sec. 9.1.2.

9.4.2 TC Monitor screen display and key functions

In this section, the TC Monitor screen display contents and the function of keys displayed at the top of the screen are explained.

(1) Display

2)

3)

	TC MONITOR	TEST	MENU	FORM	SET		
	NETWK No.[ 0]	STATION[33]					
	FILE [ABCDEF.PRG]						
	T 0 PV	0	SV	0	○	▲	
	[Production line A]						
	T 1 PV	0	SV	0	○		
	[Production line B]						
	T 2 PV	150	SV	150	■ ●		
	[Production line C]						
	T 3 PV	0	SV	0	○	▼	
	[Production line D]						

1)

When comment is not displayed: max. 8 devices  
 When comment is displayed : max. 4 devices  
 Display when system monitoring  
 T/C                      current value, set value  
 (Contact point, coil) ■ ● : ON  
                                  || ○ : OFF

1)	Displays the keys that are used with the operation of the TC Monitor screen shown in (2) (Touch input).
2)	Displays the monitor station network No. and station No. When connected to QnACPU, the execution file name is displayed (If there are more than one file, the first file name is displayed.).
3)	Displays the current value, set value, contact point and coil status of the monitor device (The screen above shows when the monitor module is 16 bits.).

(2) Key functions

The chart below shows the function of the keys that are used with the operation of the TC Monitor screen.

Key	Function
MENU	Move to basic screen (function change menu screen) for changing to another monitor function or ending the system monitor (See Sec. 9.1.1.).
FORM	Move to display change menu screen for changing the numerical display on the TC monitor screen (decimal/hexadecimal) or changing the comment display (on/off) (See Sec. 9.1.2.).
SET	Move to device setting menu screen to change the monitor device or execute a test. <ul style="list-style-type: none"> <li>• Change of monitor device (See Sec. 9.1.3)</li> <li>• Test (See Sec. 9.6.)</li> </ul>
▲ ▼	Scroll the display contents up or down one line to display the monitor device that is not displayed (just before or after the current display). Operation is enabled when monitor device comment is displayed. ▼ : Scrolls down one line. ▲ : Scrolls up one line.



9.5 BM Monitor (monitor of buffer memory)

When monitoring, the function that monitors the buffer memory of the special function module is called the "BM monitor".

The BM monitor screen when executing the system monitor is explained below.

9.5.1 Basic operation

The BM Monitor operation procedure is shown below.

See Sec. 9.1.1.

[Operation procedure]

Select "BM Monitor" with the basic screen.

.....When a screen other than the basic screen is displayed, touch **MENU** at the top of the currently displayed screen, display the basic screen, and select "BM Monitor".

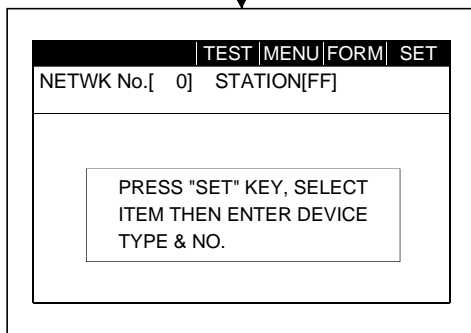

.....When you touch **MENU**, you return to the basic screen.

When you touch **FORM**, you can change this display (See Sec. 9.1.2.).

When you touch **SET**, the monitor station and device can be specified (See Sec. 9.1.3.).

Specify the initial monitor device.

(1) Specify the station and device to be monitored, and the monitor module (16-/32-bit module).

When reading is complete, display the BM Monitor screen.

(2) For the method of the specifying, see Sec.9.1.3. Specify the module to be monitored and the buffer memory as follows.

BM	Address	BM	I/O No.
BM 1110	-32768	BM 1118	0
BM 1111	64	BM 1119	0
BM 1112	149	BM 1120	150
BM 1113	-1111	BM 1121	131
BM 1114	126	BM 1122	-32768
BM 1115	160	BM 1123	555
BM 1116	255	BM 1124	2368
BM 1117	1200	BM 1125	11000

Initial Y [ ] [ ] [ ]

Specify the initial address of the buffer memory in decimal.

When the initial I/O signal of module is displayed with three digits, specify the first two digits.

Change the screen display.

.....Switching between decimal and hexadecimal display is enabled. Do this as needed. For the display change method, see Sec. 9.1.2.

9.5.2 BM Monitor screen display and key functions

In this section, the BM Monitor screen display and the functions of keys displayed at the top of the screen are explained.

(1) Display

	BM MONITOR	TEST	MENU	FORM	SET
2)	NETWK No.[ 0] STATION[FF]		I/O NO[ 1]		
3)	BM 1110	-32767	BM 1118	0	
	BM 1111	64	BM 1119	0	
	BM 1112	149	BM 1120	150	
	BM 1113	-1111	BM 1121	131	
	BM 1114	126	BM 1122	-32768	
	BM 1115	160	BM 1123	555	
	BM 1116	255	BM 1124	2368	
	BM 1117	1200	BM 1125	11000	

1) Displays current value of a maximum of 16 devices.

1)	Displays the keys that are used with the operation of the BM Monitor screen shown in (2) (Touch input).
2)	Displays the monitor station network No. and station No., and the first 2 digits of the I/O signal No. of the object module.
3)	Displays the current values of the buffer memory (The screen above shows when the monitor module is 16 bits.).

(2) Key functions

The chart below shows the function of the keys that are used with the operation of the BM Monitor screen.

Key	Function
MENU	This moves to basic screen (function change menu screen) for changing to another monitor function or ending the system monitor (See Sec. 9.1.1.).
FORM	This moves to display change menu screen for changing the number display on the BM monitor screen (decimal/hexadecimal) (See Sec. 9.1.2.).
SET	This moves to device setting menu screen to change the monitor device or execute a test. <ul style="list-style-type: none"> <li>• Change of monitor device (See Sec. 9.1.3.)</li> <li>• Test (See Sec. 9.6.)</li> </ul>

9.6 Test

**CAUTION**

- Read the manual carefully and fully understand the operation before the test operation (ON/OFF of bit devices, modifying current value of a word device, modifying timer/counter setting, modifying the current value, or modifying the current value of a buffer memory) of system monitor. In addition, never modify data in a test operation to a device which performs a crucial operation to the system. It may cause an accident by a false output or malfunction.

When monitoring with the system monitor function, you can specify an optional station or device to be monitored and test it.

The operation of testing a bit device, word device, or special module buffer memory of the PLC CPU is explained in this section.

9.6.1 Basic operation

The operation procedure for testing when monitoring with the system monitor function is shown below.

[Operation procedure]

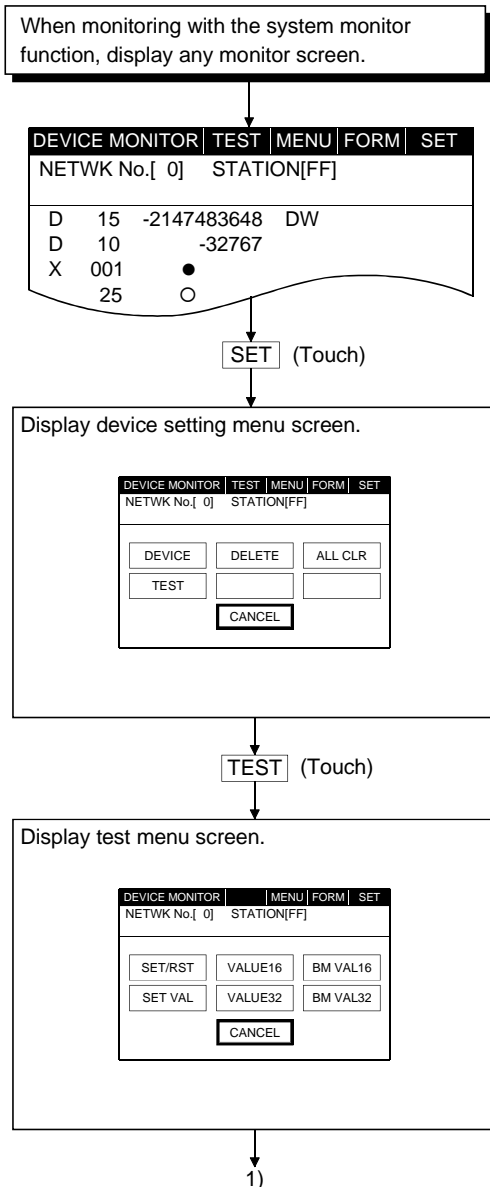

See Sec. 9.2.

.....When a screen other than the monitor screen is displayed, display any monitor screen according to the explanatory section for each monitor function.

.....When Device Monitor screen is displayed.

.....When you touch **CANCEL**, the display moves (returns) to the previous monitor screen.

.....When you touch **CANCEL**, the display moves (returns) to the previous monitor screen.

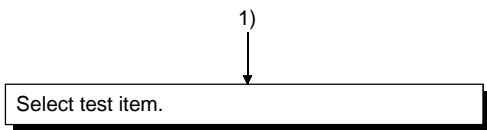

When **SET/RST** is selected.

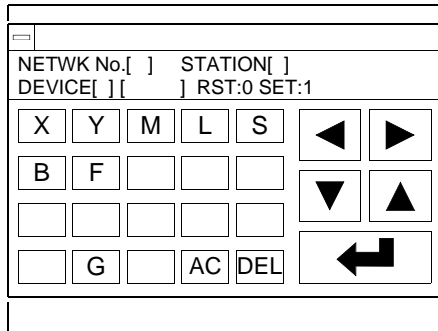

When **VALUE16** / **VALUE32** is selected.

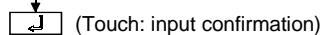
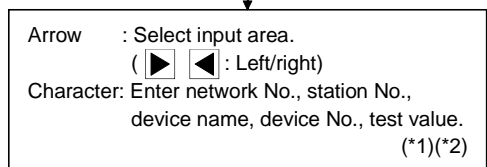
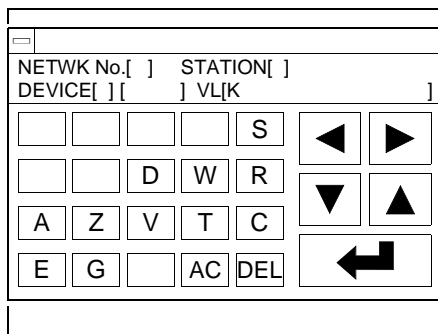

Move (return) to screen where **SET** was specified.

(1) Touch either, depending on test contents.

**SET/RST**

SET/RST (set/reset) bit device.

**VALUE16** or **VALUE32**

Change current value of word device.

**SET VALUE**

Change T, or C set value.

**BM VAL16** or **BM VAL32**

Change current value of buffer memory.

\* With VALUE16 or BM VAL16, 16 bits is the object module.

With VALUE32 or BM VAL32, 32 bits is the object module.

When **SET VALUE** is selected.

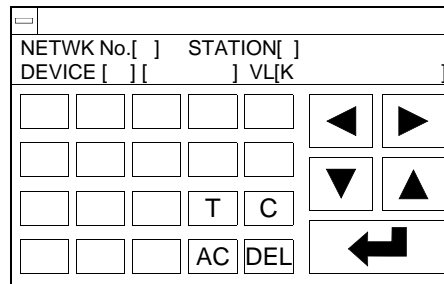

(2) Specify the network No. and station No. of the object PLC CPU (See Sec. 9.1.3, \*1.).

(For data link system)

- Network No.: 0
- Station : FF (Own station)
- 0 (Master station)
- 1 to 64 (Local station)

(For network system)

- Network No.: 0 (Host loop)
- 1 to 255 (Specify loop)
- Station : FF (Own station)
- 0 (Control station)
- 1 to 64 (Normal station)

(3) Specify object device.

(4) Specify test value.

- With SET/RST (set/reset) of bit device, specify 0 (RST) or 1 (SET).

- When changing current value of word device

When changing T or C set value

or

- When changing current value of buffer memory

Match current display form (decimal/hexadecimal) and specify change value. (\*3)

\*1 The data being entered can be cleared by using the following keys.

**AC** : Clear all data being entered in the object area.

**DEL** : Clear one character from the cursor position.

\*2 The format for the data being entered is displayed on the right side of the screen.

**DEC** : Enter in decimal.

**HEX** : Enter in hexadecimal.

\*3 Even when the setting value/current value is changed after the timer (T) has timed out and the counter (C) has finished counting, the time-up status/count-up status do not change. The current status is maintained.

(When the setting value is changed to a large value/when the current value is changed to a small value)

9.6.2 Quick test function

In addition to the existing tests for the direct input of device, station No., etc. during monitoring with the system monitor function, this function enables the bit device SET/RESET, word device, buffer memory data to change by a single touch.

1) Operation to set the quick test function on

To perform the quick test functions, perform the following operations:

[Operation procedure]

Display one of the system monitor screen.

DEVICE MONITOR	TEST	MENU	FORM	SET
NETWK No.[ 0]		STATION[FF]		
D	15	-2147483648	DW	
ZR	1042431	-32767		
X	0001	●		
M	25	○		
W	200	43		
R	50	68378428	DW	
D	0	0		
W	100	0		

.....When displaying the device monitor screen.

TEST (Touch)

DEVICE MONITOR	TEST	MENU	FORM	SET
NETWK No.[ 0]		STATION[FF]		
D		QUICK TEST MODE SET		
ZR	104			
X				
M				
W				
R				
D				
W	100	0		

.....The quick test is turned on by clicking on **OK**.

OK

DEVICE MONITOR	TEST	MENU	FORM	SET
NETWK No.[ 0]		STATION[FF]		
		<b>QUICK TEST</b>		
D	15	-2147483648	DW	
ZR	1042431	-32767		
X	0001	●		
M	25	○		
W	200	43		
R	50	68378428	DW	
D	0	0		
W	100	0		

.....Status when the quick test function is on.

2) Operation to turn off the quick test function

When **TEST** is touched when the quick test function is on, a dialog box is displayed. When **OK** is touched, the quick test can be canceled.

3) Bit device quick test

DEVICE MONITOR	TEST	MENU	FORM	SET
NETWK No.[ 0]		STATION[FF]		
<b>QUICK TEST</b>				
D	15	-2147483648	DW	
ZR	1042431	-32767		
X	0001	●		
M	25	○		
W	200	43		
R	50	68378428	DW	
D	0	0		
W	100	0		

.....When the device monitor screen is displayed.

Touch the device name or device no. display position for the bit device to be SET/RESET.

DEVICE MONITOR	TEST	MENU	FORM	SET
NETWK No.[ 0]		STATION[FF]		
<b>QUICK TEST</b>				
D	15	-2147483648	DW	
ZR	1042431	-32767		
<b>X</b>	<b>0001</b>	●		
M	25	○		
W	200	43		
R	50	68378428	DW	
D	0	0		
W	100	0		

.....The device name and device no. touched is displayed highlighted.

When the on/off display (○, ●) of the highlighted display is touched, the status is SET/RESET.

\* When the current bit device is ON, then it is turned OFF (RESET).

When OFF, it will be (SET).

DEVICE MONITOR	TEST	MENU	FORM	SET
NETWK No.[ 0]		STATION[FF]		
<b>QUICK TEST</b>				
D	15	-2147483648	DW	
ZR	1042431	-32767		
X	0001	○		
M	25	○		
W	200	43		
R	50	68378428	DW	
D	0	0		
W	100	0		

.....The on/off display area (○, ●) of the X0001 device is highlighted.

4) Quick test for the word device, T/C monitor, and buffer memory

.....When displaying the device monitor screen.

Touch the display position of the device to be changed.

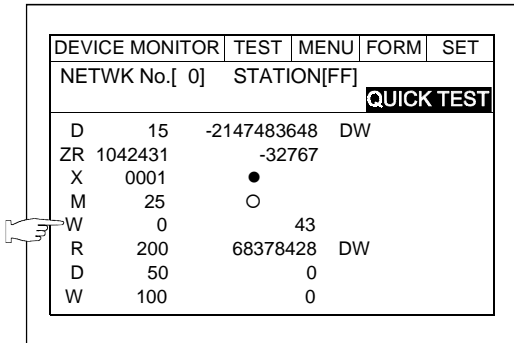

.....The change value input screen is displayed.

Enter the current value to be changed in the KEY window.

See Section 8.1.3 for the KEY window operations.

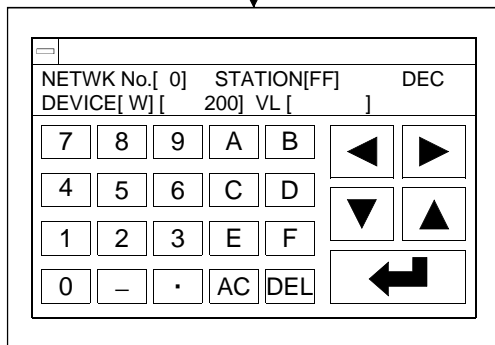





Chapter10 Error display and handling with system monitoring

The following chart shows the error messages that may be displayed when operating the system monitor and the method of handling them.

Error Message	Description	Method of Handling
PLC communications error	Communication could not be established with the PLC CPU.	Check the following: <ul style="list-style-type: none"><li>• Connections between the PLC CPU and the GOT (disconnected or cut cables).</li><li>• Has an error occurred in the PLC CPU?</li></ul>



Chapter11 Operation procedures for special module monitor function

The operation procedure when using the special module monitor function is explained in this chapter.

11.1 Operation procedures before starting special module monitoring

This section contains a summary of the procedure for transmitting the system program (OS) for the special module monitor function and the special module monitor data from the personal computer to the GOT until it is installed in built-in memory. For details, please refer to the Help in Drawing Software. Details of the screen display and key operation are shown in the Help.

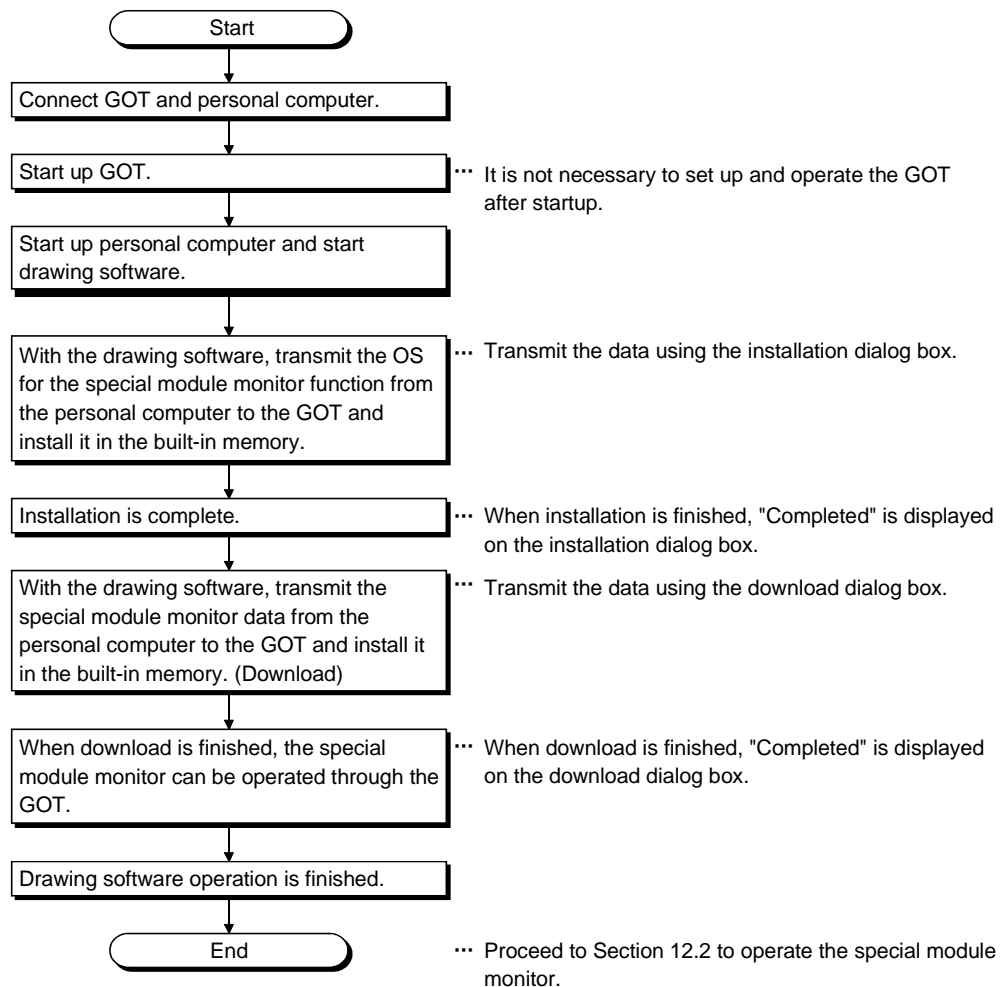

11.2 Operation procedures from user-created monitor screen display to start of special module monitor

This section describes the operation procedure for the GOT when starting each operation of the special module monitor function after the system program (OS) of the special module monitor function has been installed in the GOT built-in memory, and downloading the special module monitor data.

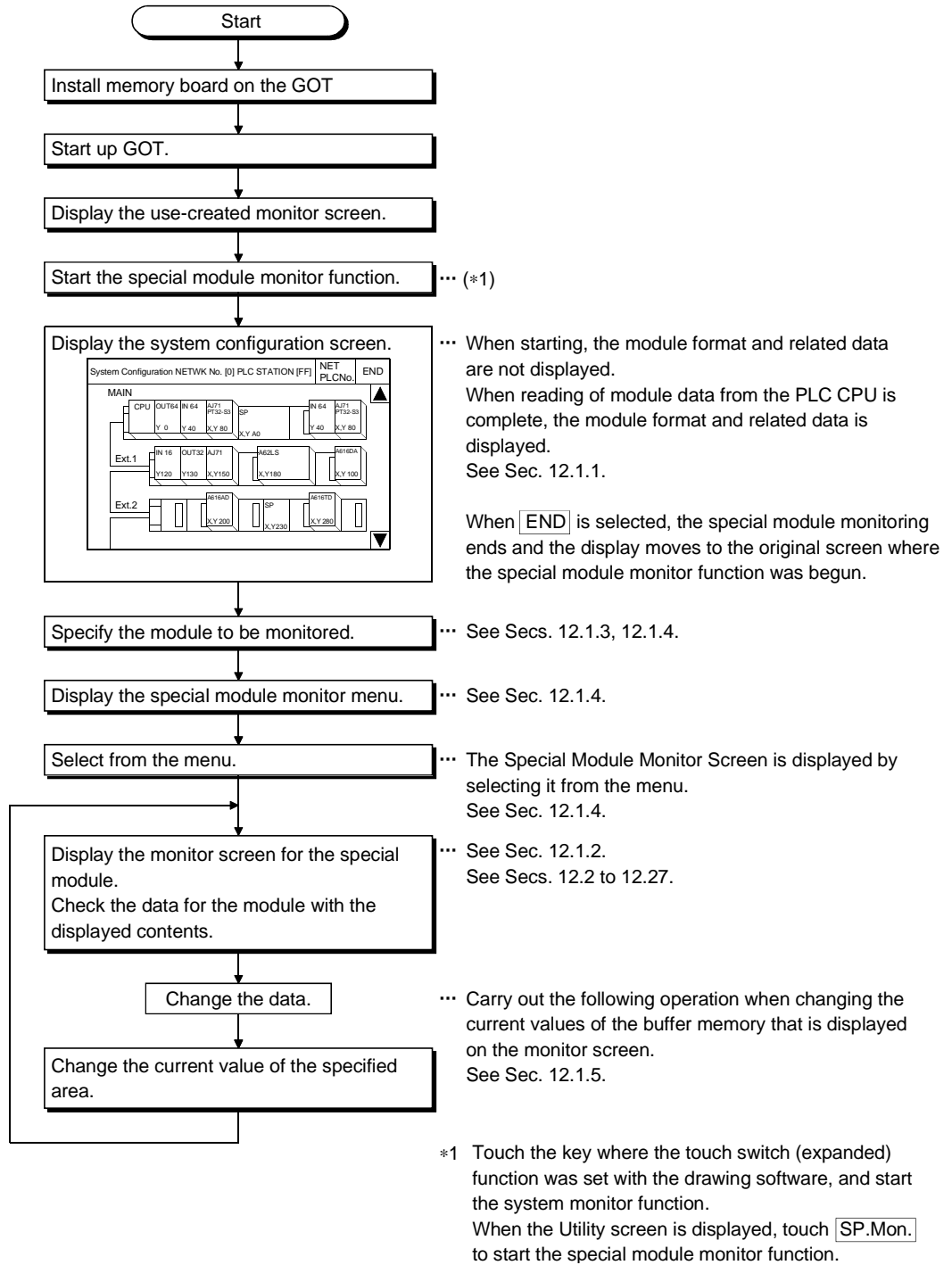

Chapter12 Operation of each special module monitor screen

Each screen operation when using the special module monitor function is explained in this chapter.

12.1 Screen configuration, common operation and changing screens when monitoring

The screen configuration and common operations used when executing the special module monitor are explained in this section.

12.1.1 Composition of system configuration screen and key functions

This section describes the structure of the system configuration screen that is displayed after starting the special module monitor function and the key functions displayed on the screen.

(1) Display

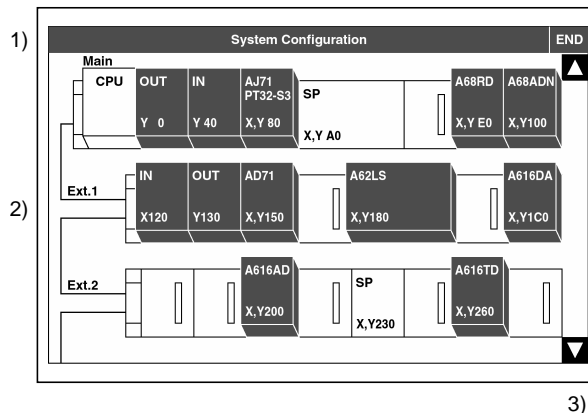

The module format and related data are displayed at the end of the module data readout from the PLC CPU. (OS executes it automatically.)  
When connected to MELSECNET, the screen shown in Section 12.1.3 is displayed.

1)	Displays network No. and station No.. of monitor station.
2)	With the module installed in the monitor station, the special function module displays the format and the initial no. of the I/O signal with the sequencer CPU; the I/O module displays "Input"/"Output" and the I/O points. For a special function module that cannot be monitored, "Special" and the initial no. of the I/O signal are displayed. The display position of the module is the key for moving the special function module monitor of that module to the screen where it is executed (Touch input)
3)	The keys used for the operation with the System Configuration screen shown in (2) are displayed. (Touch input)

(2) Key functions

The chart below shows the functions of the keys that are used with the System Configuration screen operation.

Key	Function
END	Monitoring ends; and display returns to the screen where the special module monitor function was begun.
Module display position	Moves to screen where the special module monitor for that module is executed. Slots 0 through 7 are valid for each base module.

Key	Function
▲ ▼	Scrolls display up or down one level to display the system configuration of the level number just before or after the one that is currently displayed. Operation of these keys is enabled when the system configuration extends to three levels or more. ▼: Scrolls down one level. ▲: Scrolls up one level.

12.1.2 Monitor screen configuration and key functions

This section describes the structure of the monitor screen that is displayed by specifying the module with the system configuration screen, and the key functions that are displayed at the top of the screen.

(1) Display (with A68RD)

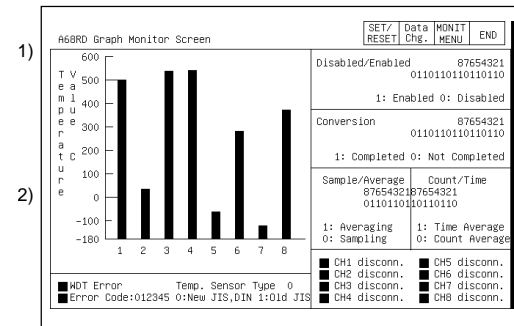

3) All types of data are displayed when the readout from the special function module is complete.  
(OS executes it automatically.)

1)	Displays format of module being monitored.
2)	Displays buffer memory data of object module in its current form, or in a graph. Display status of I/O signal with the PLC CPU. When testing, tests after moving the cursor to the display position of the target data.
3)	The keys used for the operation with the monitor screen shown in (2) are displayed. (Touch input)

(2) Key functions

The chart below shows the functions of the keys that are used with the System monitor screen operation.

Key	Function
END	Monitoring ends; and display returns to the screen where the special module monitor function was begun.
MONIT MENU	Ends current monitoring and moves to screen that shows monitor menu. Operation can be used only if the special function module has a Monitor menu.
Data Chg.	Starts change of current values for buffer memory of special function module displayed on screen.
SET/ RESET	Starts test set/reset for I/O signal between PLC CPU and special function module.

12.1.3 Setting method for remote station monitoring

The setting method to perform remote station monitoring during special module monitoring is described below.

<Special Module Monitor>

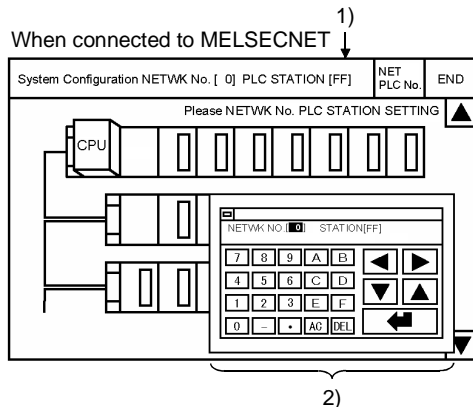

Touch **SP.UNIT** to display the system configuration screen. Depending on the connection method, the screen first displayed will be different as indicated below.

Bus connection and CPU direct connection	The base of the connection station is displayed.
MELSECNET (II), /B connection	No system configuration display
MELSECNET/10 connection	No system configuration display

for MELSECNET connections, the following operations will always be required:

- 1) Touch **NETPCNo.** to display the window shown in 2)
- 2) Touch **Alphanumeric** to specify the network No. and PLC station No..

**Alphanumeric** .. Enter the network No. and PLC station No..

◀ ▶ ..... Select the input area.

← ..... Set the area value.

In the case of data link systems	
NETWK NO. :	0
STATION :	FF (Host)
	: 0 (Master station)
	: 1 to 64 (Local station)

In the case of network systems	
NETWK NO. :	0 (Host loop)
	: 1 to 255 (Specified loop)
STATION :	FF (Host)
	: 0 (Station number of management station)
	: 1 to 64 (Normal station)

When the setting is finished, the system configuration of the specified station is displayed.

See Sec. 12.1.4 for operations which come after these operations.



12.1.4 Specifying monitor module and selecting monitor menu

The operation when starting the special module monitor for an optional module is explained, using the positioning module (AD71) as an example.

[Operation procedure]

Display System Configuration screen. ... See Sec. 12.1.1.

[Specify module to be monitored] (Touch display position of module.)

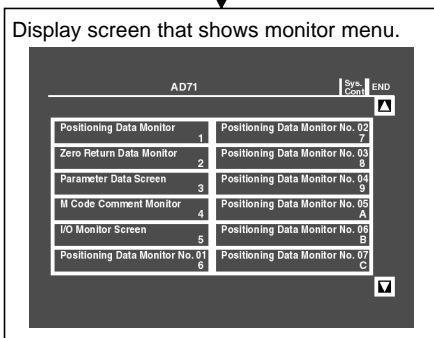

[Specify menu to be monitored] (Touch display position of menu.)

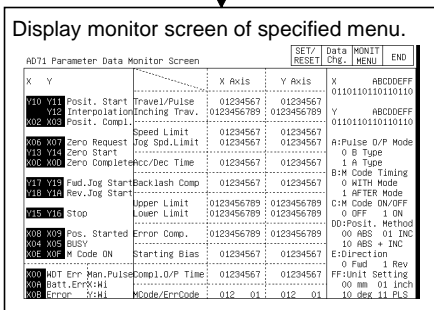

Proceed to Sec. 12.1.5 and Secs. 12.2 to 12.27.

(1) From the modules assigned to slots 0 through 7 of each base unit, specify the special function module where the format is displayed.

\* For modules where the format is not displayed, monitor with the system monitor function (See Sec. 9.5.).

Specify input/output modules according to Sec. 13.1.

(2) Specify the menu corresponding to the type of data to be monitored.

(3) With modules for which the monitor menu cannot all be displayed in one screen, touch the ▲ ▼ keys at the right of the screen to scroll the display menu.

(4) Check the contents of the display. Carry out the subsequent operation according to Sec. 12.2 to 12.27.

(5) Carry out tests for the displayed data according to Sec. 12.1.5.

- Change current value of buffer memory
- Turn output signal from PLC CPU on and off

12.1.5 Test for special function module



**CAUTION**

- Read the manual carefully and fully understand the operation before the test operation (modifying the current value of a buffer memory) of special function module monitor.
- In addition, never modify data in a test operation to a device which performs a crucial operation to the system. It may cause an accident by a false output or malfunction.

Testing can be performed for all buffer memory data displayed on the current monitor screen.

This section describes the operation for changing the current value of the buffer memory and turning the output signal from the PLC CPU to the special module on and off.

**POINTS**

- (1) When testing, test for the buffer memory to be written in from the PLC CPU and the output signal that is output from the PLC CPU.
- (2) Be sure to carry out the test operation with the PLC CPU in STOP status. If the PLC CPU is tested during RUN status, it returns to the output values and output status from the sequence program.

[Operation procedure]

Display monitor screen.

AD71 Parameter Data Monitor Screen				SET/RESET	Data Chg.	MONIT	END
X	Y	X Axis	Y Axis	X	Y		
X10	Y11	Posit. Start	Travel/Pulse	01234567	01234567	X	ABCDDEFF
Y12		Interpolation	Enching Trav.	0123456789	0123456789	Y	ABCDDEFF
X02	X03	Posit. Compl.	Speed Limit	01234567	01234567	X	0110110110110110
X06	X07	Zero Request	Jog Spd.Limit	01234567	01234567	A:Pulse O/P Mode	
Y13	Y14	Zero Start	Acc/Dec Time	01234567	01234567	0 B Type	
X0C	X0D	Zero Complete	Backlash Comp	01234567	01234567	1 H Type	
Y17	Y19	Fwd.Jog Start	Upper Limit	0123456789	0123456789	B:M Code Limiting	
Y18	Y18	Rev.Jog Start	Lower Limit	0123456789	0123456789	0 RITH Mode	
Y15	Y16	Stop	Error Comp.	0123456789	0123456789	1 AFTER Mode	
X08	X09	Pos. Started	Starting Bias	01234567	01234567	C:M Code Div/OFF	
X04	X05	BUSY	Comp1.O/P Time	01234567	01234567	0 OFF 1 ON	
X0E	X0F	H Code ON	Mode/ErrCode	012	01	00:Posit. Method	
X00	X01	Err Man.Pulse				00 ABS 01 Inv	
X0A	X0B	Batt.ErrK-WL				10 ABS * INC	
X08	X09	Errc. YSWL				E:Direction	
						0 Fwd 1 Rev	
						FF:unit Setting	
						00 mm 01 Inch	
						10.962.11.PLS	

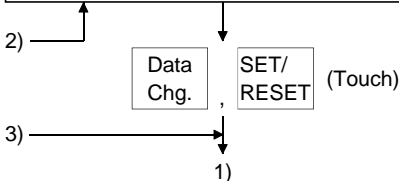

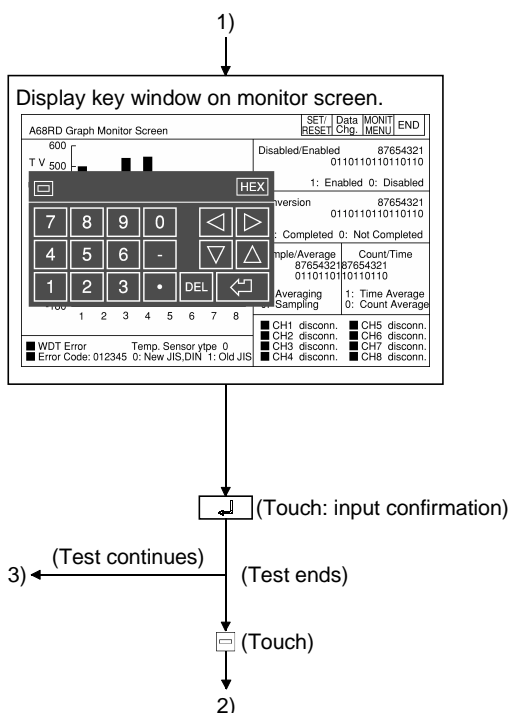

When **Data Chg.** is touched (changes current value of buffer memory)

- All of the following operations can be carried out by touching the keys in the displayed key window.
- When you touch  at the upper left of the key window, the key window closes and the display returns to the monitor screen.

(1) Move the cursor to the position where the data to be tested is displayed. (\*1)

(▲ ▼ : Up/down ▶ ◀ : Left/right)

(2) Use the numeric keys to specify the value to be changed. (\*2)

The **DEL** key can be used to clear individual characters among those input.

When **SET/RESET** is touched (tests the I/O signal)

- All of the following operations can be carried out by touching the keys in the displayed key window.
- When you touch  at the upper left of the key window, the key window closes and the display returns to the monitor screen.

(1) Use the alphabetic character keys to specify the name of the device to be tested, and then touch . (\*1)

(2) Use the numeric keys to specify the device number, and then touch .

(3) Use the numeric keys to specify "Set" or "Reset".

**0** : OFF    **1** : ON

\*1 Do not perform the following tests.

When testing, the module may not operate correctly or the buffer memory/input signal may return to the output value/output status from the special function module.

- 1) Test the buffer memory for reading-only from the PLC CPU.
- 2) Test the input signal to the PLC CPU from the special function module.

\*2 When testing buffer memory data, specify the change value in the following way.

- 1) For data where 16/32 bits is displayed with one number, specify the change value in decimal.
- 2) For data where one number of 16/32 bits is displayed as a percent, such as with an A/D conversion module, specify the change value corresponding to the percentage in decimal.

Example:

When the set value of the offset or gain is 0 to 2000, when specifying a change value of 50%, input 1000.

- 3) For data where 16 bits is displayed one bit at a time as "0" and "1", specify the change value of 16 bits in decimal.

12.1.6 Changing the screen

This section describes how to change the screen when executing each monitor function of the special module monitor function from the status where the user-created monitor screen is displayed.

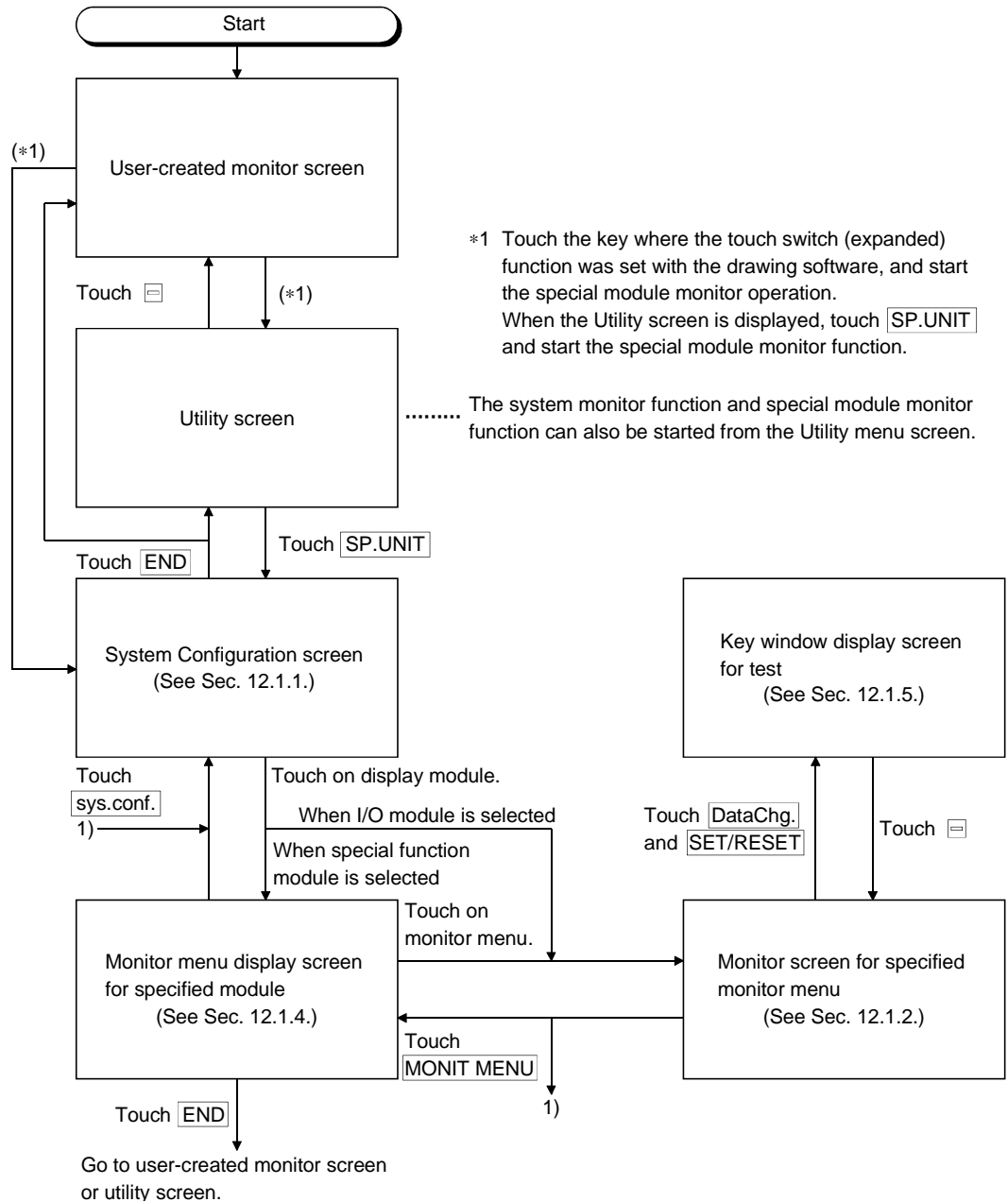

12.2 A61LS module monitor

12.2.1 Operation monitor

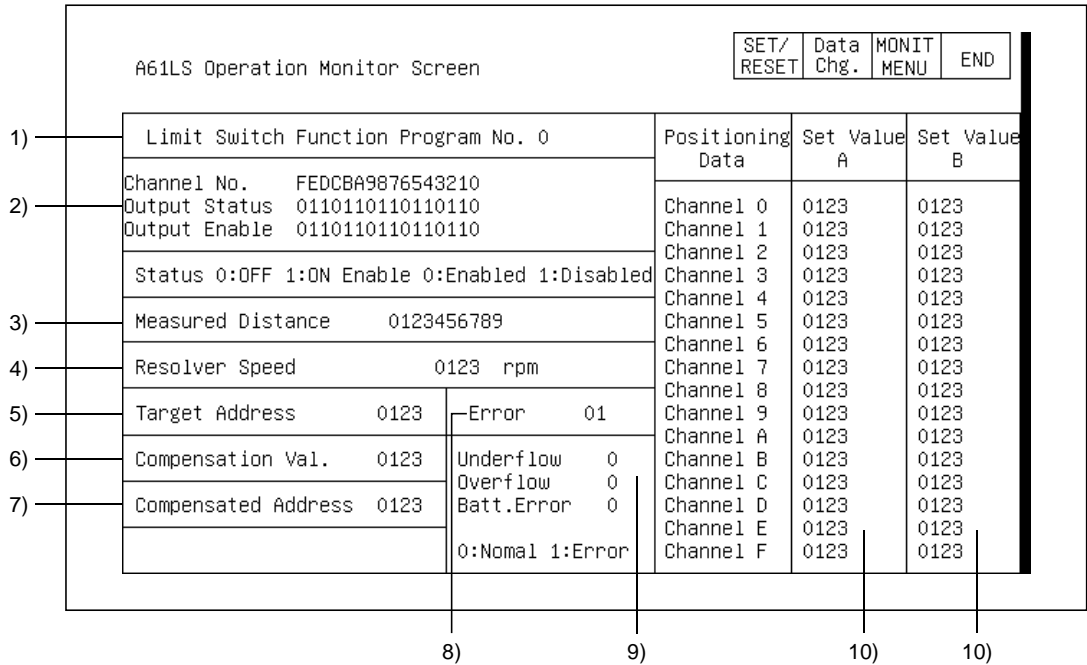

No.	Contents of display	Buffer memory address to reference (decimal)
1)	The number of the program being used is displayed.	11
2)	The output status of each channel is displayed.	4
	The specified status for the Output Enable command of each channel is displayed.	10
3)	The measured distance value for the distance detection function is displayed.	5, 6
4)	The rotation speed of the resolver connected to A61LS is displayed.	3
5)	The set value of the target address for the positioning function is displayed.	12
6)	The compensation value for the zero point compensation function is displayed.	7
7)	The current value of the resolver after compensation by the zero point compensation function is displayed.	0
8)	The error code is displayed when an error occurs.	8
9)	When an A61LS resolver underflow is detected, "1" is displayed.	2
	When an A61LS resolver overflows is detected, "1" is displayed.	1
	When a low battery charge is detected, "1" is displayed.	9
10)	The set values A and B for executing the positioning function are displayed for each channel.	13 to 44

12.2.2 I/O monitor

A61LS Input/Output Monitor Screen

Inputs (X)		Outputs (Y)	
00	WDT Error 10	00	10 PLC READY
01	Online 11	01	11 Posit. Start
02	Overflow Detect. 12	02	12 Limit Func.Start
03	Underflow Detect. 13	03	13 Overflow Reset
04	Resolver Direct. 14	04	14 Underflow Reset
05	Comp. Val. Exceed 15	05	15 Error Reset
06	Resolver Error 16	06	16
07	Error Detect 17	07	17
08	CH0 ON/OFF Status 18	08	18
09	CH1 ON/OFF Status 19	09	19
0A	CH2 ON/OFF Status 1A	0A	1A
0B	CH3 ON/OFF Status 1B	0B	1B
0C	CH4 ON/OFF Status 1C	0C	1C
0D	CH5 ON/OFF Status 1D	0D	1D
0E	CH6 ON/OFF Status 1E	0E	1E
0F	CH7 ON/OFF Status 1F	0F	1F

SET/ RESET	Data Chg.	MONIT MENU	END
---------------	--------------	---------------	-----

1) —

No.	Contents of display
1)	The ON/OFF status of the I/O signal corresponding to the PLC CPU is displayed. The I/O signal is ON when displayed in a reverse display.

12.3 AD61 module monitor

12.3.1 Operation monitor

AD61 Operation Monitor Screen				SET/ RESET	Data Chg.	MONIT MENU	END
Channel 1	Present Value	Set Value	Mode	Mode			
Channel 2	01234567 1)	01234567 2)	0 3)	1: 1-Phase			
	01234567	01234567	0	2: 2-Phase			
Inputs (X)				Outputs (Y)			
00	CH1 Count Greater	10	00	10	CH1 Equal Reset		
01	CH1 Count Equal	11	01	11	CH1 Preset Cmd.		
02	CH1 Count Less	12	02	12	CH1 Equal O/P		
03	CH1 Ext. Preset	13	03	13	CH1 Down Count		
04	CH2 Count Greater	14	04	14	CH1 Count Enable		
05	CH2 Count Equal	15	05	15	CH1 Value Read		
06	CH2 Count Less	16	06	16	CH1 Ext. Preset		
07	CH2 Ext. Preset	17	07	17	CH2 Equal Reset		
08		18	08	18	CH2 Preset Cmd.		
09		19	09	19	CH2 Equal O/P		
0A		1A	0A	1A	CH2 Down Count		
0B		1B	0B	1B	CH2 Count Enable		
0C		1C	0C	1C	CH2 Value Read		
0D		1D	0D	1D	CH2 Ext. Preset		
0E		1E	0E	1E			
0F		1F	0F	1F			

No.	Contents of display	Buffer memory address to reference (decimal)
1)	The current values of channels 1 and 2 are displayed.	4, 5, 36, 37
2)	The set values of channels 1 and 2 are displayed.	6, 7, 38, 39
3)	The specified status of the mode register of channels 1 and 2 is displayed.	3, 35
4)	The ON/OFF status of the I/O signal corresponding to the PLC CPU is displayed. The I/O signal is ON when displayed in a reverse display.	—

12.4 A1SD61 module monitor

12.4.1 Operation monitor

The Channel 1 and 2 Monitor Screen is used as an example.

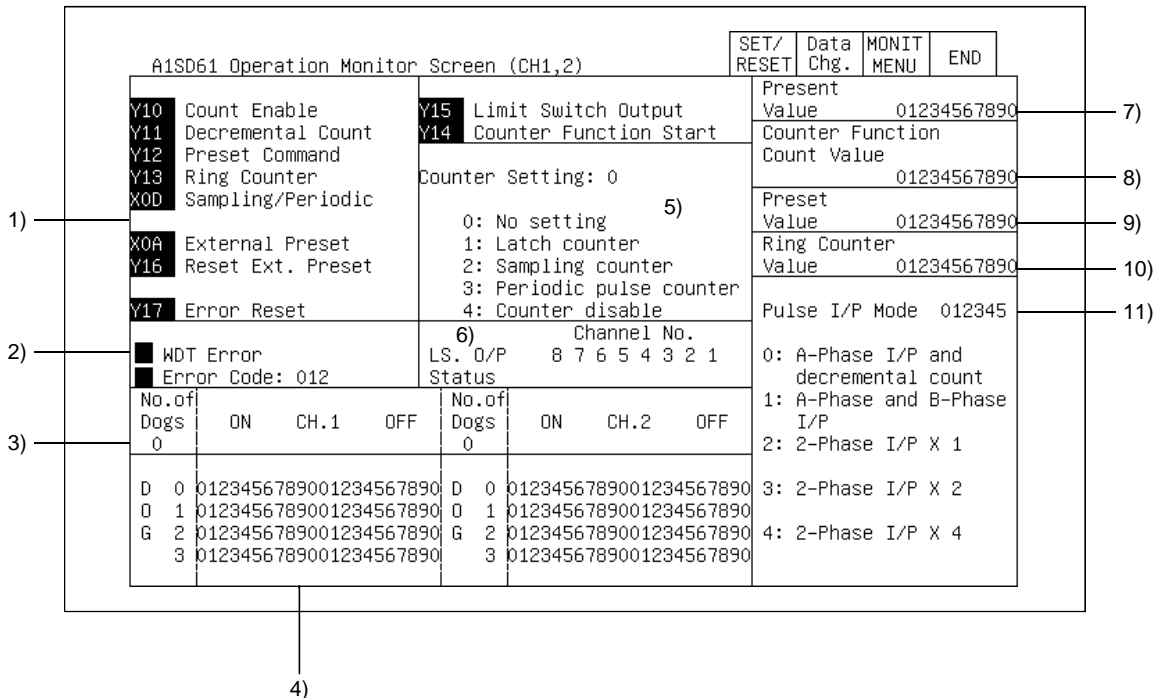

No.	Contents of display	Buffer memory address to reference (decimal)
1)	The ON/OFF status of the I/O signal corresponding to the PLC CPU is displayed. The I/O signal is ON when displayed in a reverse display.	—
2)	A "■" is displayed when a watchdog timer error occurs. A "■" is displayed when a writing data error occurs; the channel where it occurred and the error code are displayed.	— 11
3)	The number of multi-dogs that are set is displayed.	12 to 147
4)	The set value for the on position and off position of the multi-dog no. is displayed for each channel.	12 to 147
5)	The specified status of the counter function selection is displayed.	5
6)	The limit switch output status of each channel is displayed. 0: OFF      1: ON	—
7)	The current value of the counter is displayed for the following situations: in pulse input mode, when preset, when the ring counter function is being executed, and when the counter is disabled.	0, 1
8)	The count value for execution of the latch counter, sampling counter, and periodic pulse counter set with the counter function selection (5) is displayed.	2, 3
9)	The preset value is displayed.	6, 7
10)	The ring counter value that was set is displayed.	8, 9
11)	The set status of the pulse input mode is displayed.	4



12.4.2 I/O monitor

A1SD61 Input/Output Monitor Screen				SET/ RESET	Data Chg.	MONIT MENU	END
Inputs (X)			Outputs (Y)				
00	WDT Error	10	00	10	Count Enable		
01	CH1 LS Output	11	01	11	Decrement Count		
02	CH2 LS Output	12	02	12	Preset Command		
03	CH3 LS Output	13	03	13	Ring Counter		
04	CH4 LS Output	14	04	14	Counter Function		
05	CH5 LS Output	15	05	15	LS Output		
06	CH6 LS Output	16	06	16	Reset Preset		
07	CH7 LS Output	17	07	17	Error Reset		
08	CH8 LS Output	18	08	18			
09	LS O/P Enable	19	09	19			
0A	Ext. Preset	1A	0A	1A			
0B	Error Flag	1B	0B	1B			
0C	Fuse/Power OFF	1C	0C	1C			
0D	Sampling/Period	1D	0D	1D			
0E		1E	0E	1E			
0F		1F	0F	1F			

1)

No.	Contents of display
1)	The ON/OFF status of the I/O signal corresponding to the PLC CPU is displayed. The I/O signal is ON when displayed in a reverse display.

## 12. OPERATION OF EACH SPECIAL MODULE MONITOR SCREEN

MELSEC GOT

### 12.5 A62DA-S1 module monitor

#### 12.5.1 Operation monitor

A62DA-S1 Operation Monitor Screen				SET/ RESET	Data Chg.	MONIT MENU	END
Channel 1 Output 01234.6 % 1)	Voltage check 0123 Current check 2) 0123	Channel 2 Output 01234.6 % 1)	Voltage check 0123 Current check 2) 0123				
Inputs (X)				Outputs (Y)			
00 WDT Error	10	00	10				
01 READY	11	01	11				
02	12	02	12				
03	13	03	13				
04	14	04	14				
05	15	05	15				
06	16	06	16				
07	17	07	17				
08	18	08	18				
09	19	09	19				
0A	1A	0A	1A				
0B	1B	0B	1B Output Enable				
0C	1C	0C	1C				
0D	1D	0D	1D				
0E	1E	0E	1E				
0F	1F	0F	1F				

No.	Contents of display	Buffer memory address to reference (decimal)
1)	The current input value, a value between 0 to 4000 for the digital input value of channels 1 and 2, is displayed as a percentage ranging from 0 to 100%.	0, 1
2)	"1" is displayed for Output Over when an input value of 4001 or greater was set for channel 1 or 2; "1" is displayed for Output Under when a negative number was set.	2 to 5
3)	The ON/OFF status of the I/O signal corresponding to the PLC CPU is displayed. The I/O signal is ON when displayed in a reverse display.	—

12.5.2 Graph monitor

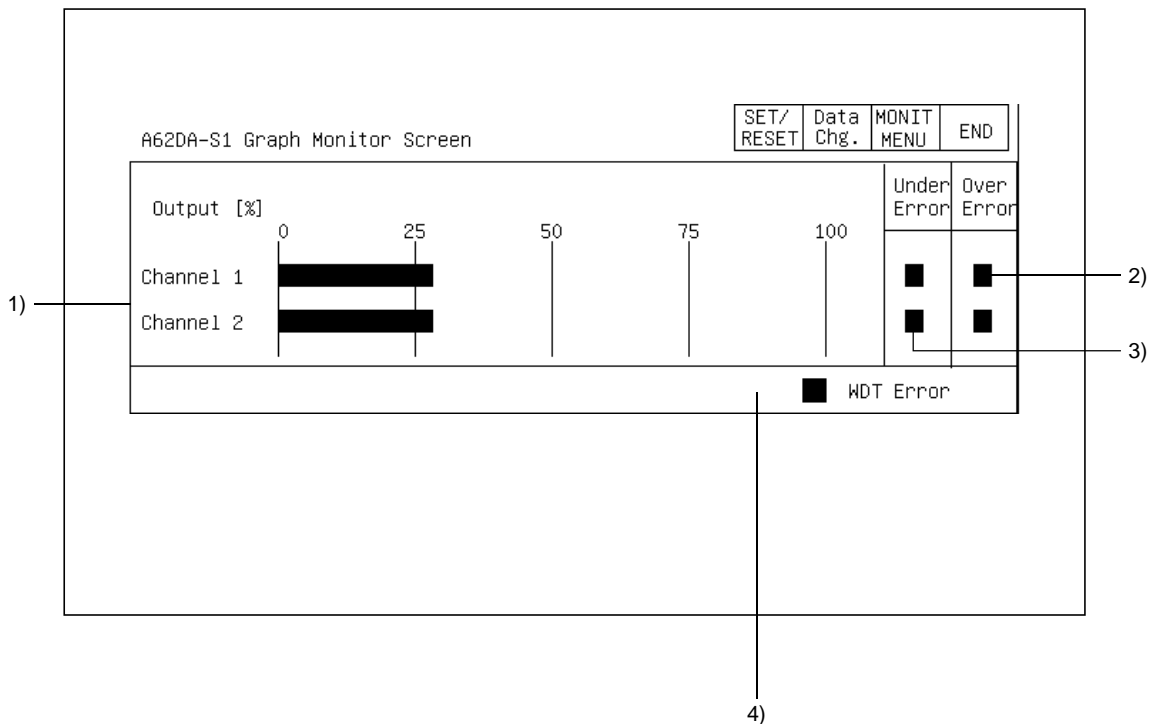

No.	Contents of display	Buffer memory address to reference (decimal)
1)	The current input value, a value between 0 to 4000 for the digital input value of channels 1 and 2, is displayed as a percentage ranging from 0 to 100%.	0, 1
2)	A "■" is displayed in the Over Error column when an input value of 4001 or greater was set for channel 1 or 2.	2, 4
3)	A "■" is displayed in the Under Error column when an input value consisting of a negative number was set for channel 1 or 2.	3, 5
4)	A "■" is displayed when a watchdog timer error occurs.	—

12.6 A1S62DA module monitor

12.6.1 Operation monitor

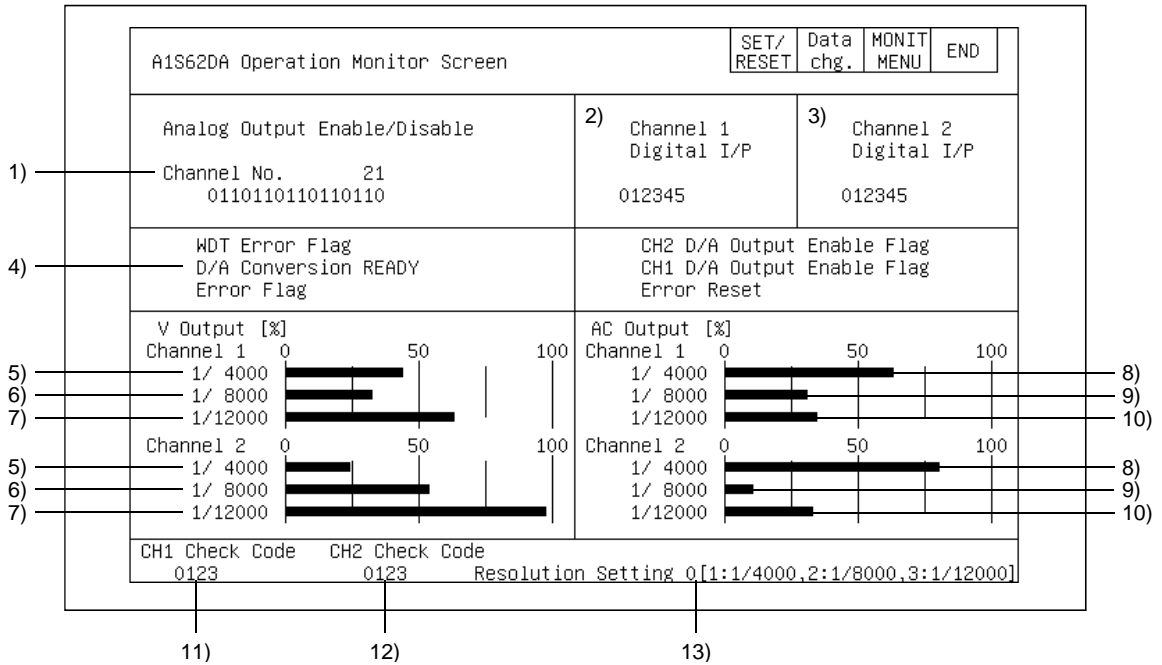

No.	Contents of display	Buffer memory address to reference (decimal)
1)	The specified enable/disable status for the analog output of each channel is displayed. 0: Enable 1: Disable	0
2)	The channel 1 digital input value is displayed.	1
3)	The channel 2 digital input value is displayed.	2
4)	The ON/OFF status of the I/O signal corresponding to the PLC CPU is displayed. The I/O signal is ON when displayed in a reverse display.	—
5)	The current input value, a value between -4000 to 4000 for the digital input value of channels 1 and 2, is displayed in a graph as a percentage ranging from 0 to 100%	1, 2
6)	The current input value, a value between -8000 to 8000 for the digital input value of channels 1 and 2, is displayed in a graph as a percentage ranging from 0 to 100%	
7)	The current input value, a value between -12000 to 12000 for the digital input value of channels 1 and 2, is displayed in a graph as a percentage ranging from 0 to 100%	
8)	The current input value, a value between 0 to 4000 for the digital input value of channels 1 and 2, is displayed in a graph as a percentage ranging from 0 to 100%	
9)	The current input value, a value between 0 to 8000 for the digital input value of channels 1 and 2, is displayed in a graph as a percentage ranging from 0 to 100%	
10)	The current input value, a value between 0 to 12000 for the digital input value of channels 1 and 2, is displayed in a graph as a percentage ranging from 0 to 100%	
11)	When the channel 1 digital input value was set outside the allowable setting range, a check code is displayed.	
12)	When the channel 2 digital input value was set outside the allowable setting range, a check code is displayed.	11
13)	The set resolution selection is displayed. 1: 1/4000 2: 1/8000 3: 1/12000	9

12.7 A62LS module monitor

12.7.1 Operation monitor

As a screen example, we will store the monitor screens from CH. 0 to CH. 3 in the memory.

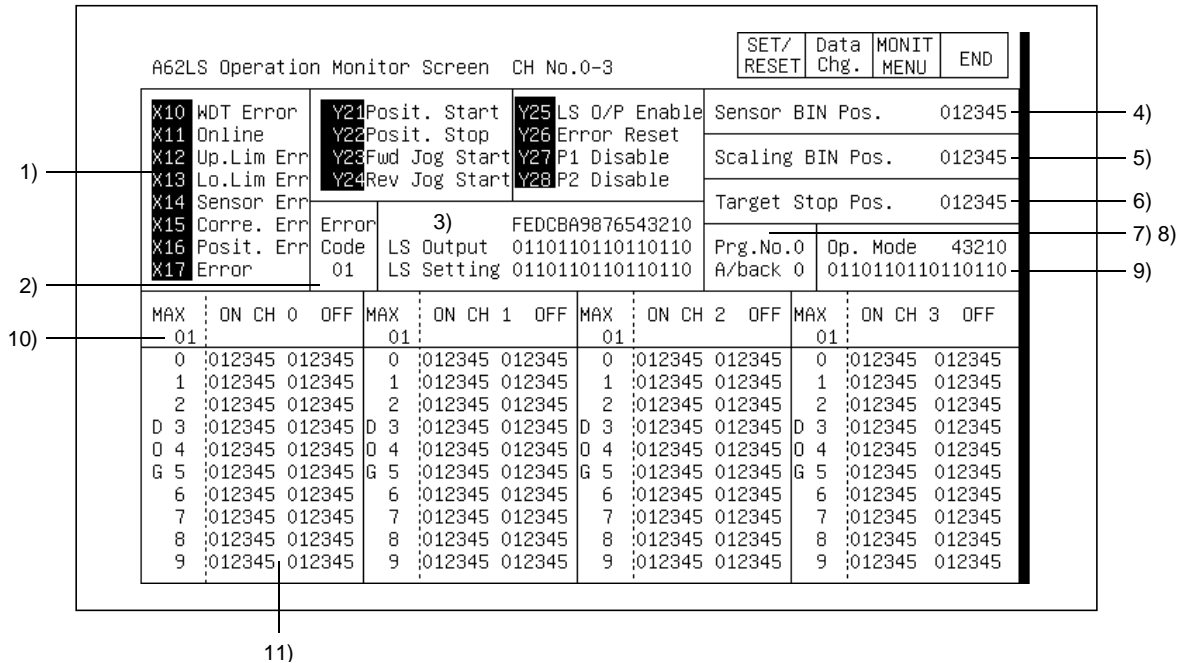

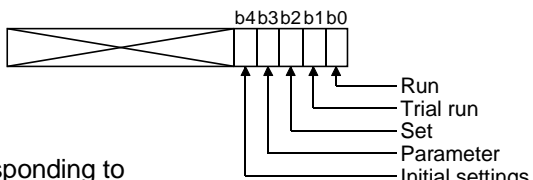
No.	Contents of display	Buffer memory address to reference (decimal)
1)	The ON/OFF status of the I/O signal corresponding to the PLC CPU is displayed. The I/O signal is ON when displayed in a reverse display.	—
2)	The error code is displayed when an error occurs.	7
3)	The output status of each channel is displayed. 0: OFF      1: ON	4
	The set limit switch output enable/disable status for each channel is displayed. 0: Enable    1: Disable	8
4)	The sensor binary current value is displayed.	2, 3
5)	After module conversion of the sensor binary current value to mm or inches, the value added to the minimum current value is displayed as the scaling binary current value.	0, 1
6)	The set value of the positioning object stop position is displayed.	10, 11
7)	The program number used with the limit switch output function is displayed.	9
8)	The answer back program number corresponding to the program number used with the limit switch output function is displayed.	5
9)	The A62LS operation mode status is displayed.   "1" is displayed in the bit corresponding to the selected operation mode.	6
10)	The number of multi-dogs that are set is displayed.	12 to 226
11)	The set value for the on position and off position of the multi-dog No. is displayed for each channel.	12 to 226

12.7.2 I/O monitor

SET/ RESET	Data Chg.	MONIT MENU	END
---------------	--------------	---------------	-----

A62LS Input/Output Monitor Screen

Inputs (X)				Outputs (Y)			
00	10	WDT Error	20	00	10	PLC READY	
01	11	Online	21	01	11	Posit. Start	
02	12	Upper Lim.Error	22	02	12	Posit. Stop	
03	13	Lower Lim.Error	23	03	13	Fwd Jog Start	
04	14	Sensor Error	24	04	14	Rev Jog Start	
05	15	Correction Err.	25	05	15	LS O/P Enable	
06	16	Position Error	26	06	16	Error Reset	
07	17	Error	27	07	17	P1 Disable	
08	18	CH 0/8 Status	28	08	18	P2 Disable	
09	19	CH 1/9 Status	29	09	19		
0A	1A	CH 2/10 Status	2A	0A	1A		
0B	1B	CH 3/11 Status	2B	0B	1B		
0C	1C	CH 4/12 Status	2C	0C	1C		
0D	1D	CH 5/13 Status	2D	0D	1D		
0E	1E	CH 6/14 Status	2E	0E	1E		
0F	1F	CH 7/15 Status	2F	0F	1F		

1) —

No.	Contents of display
1)	The ON/OFF status of the I/O signal corresponding to the PLC CPU is displayed. The I/O signal is ON when displayed in a reverse display.

12.8 A1S62RD module monitor

12.8.1 Operation monitor

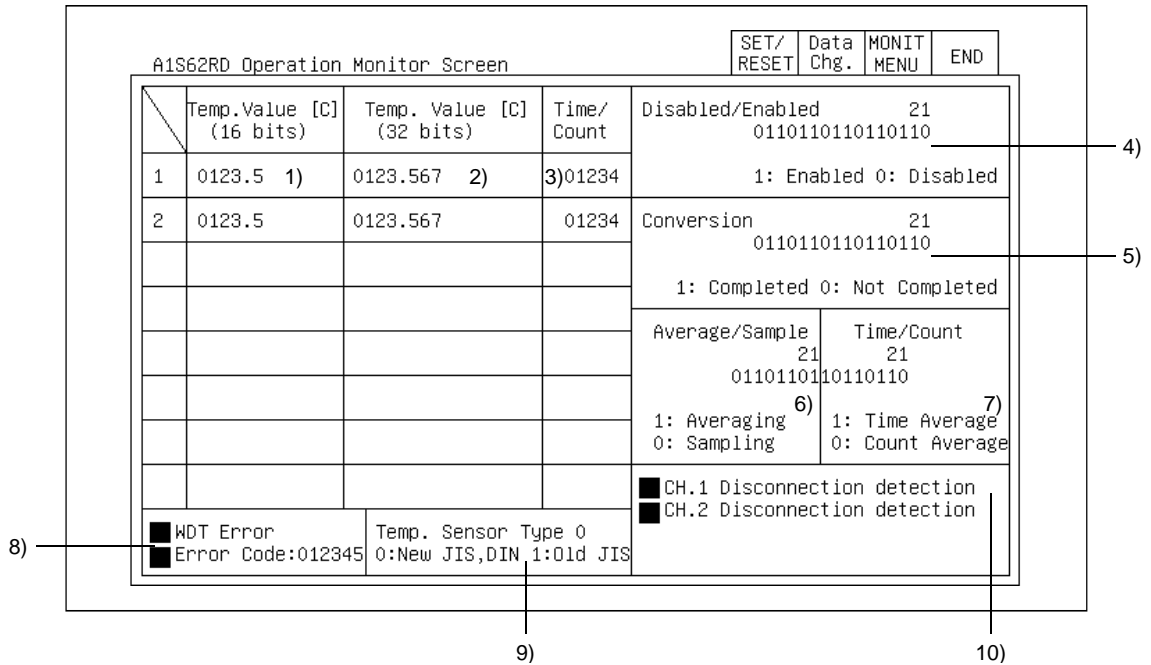

No.	Contents of display	Buffer memory address to reference (decimal)
1)	The temperature detection value of each channel is displayed up to 1 digit after the decimal point.	10, 11
2)	The temperature detection value of each channel is displayed up to 3 digits after the decimal point.	18 to 21
3)	The values set for the time and count of times for averaging processing of each of the channels is displayed.	2, 3
4)	The specified conversion enabled/disabled status of each channel is displayed.	0
5)	The Conversion Completed flag status for each channel is displayed.	35
6)	The specified status for the averaging processing/sampling processing of each channel is displayed.	1
7)	The specified status for the averaging processing of each channel is displayed.	1
8)	A "■" is displayed when a watchdog timer error occurs.	—
	A "■" is displayed when a writing data error occurs; the channel where it occurred and error code are displayed.	34
9)	The specified status of the platinum temperature sensor that is used is displayed.	36
10)	For A1S62RD3	—
	A "■" is displayed in a channel where broken wire was detected.	
	For A1S62RD4	
	A "■" is displayed in CH1 when a broken wire is detected in any channel.	

12.8.2 I/O monitor

A1S62RD Input/Output Monitor Screen				SET/ RESET	Data Chg.	MONIT MENU	END
Inputs (X)			Outputs (Y)				
00	WDT Error	10	00	10			
01	READY	11	01	11			
02	Error Detection	12	02	12	Error Reset		
03	CH1 Disconnected	13	03	13			
04	CH2 Disconnected	14	04	14			
05		15	05	15			
06		16	06	16			
07		17	07	17			
08		18	08	18			
09		19	09	19			
0A		1A	0A	1A			
0B		1B	0B	1B			
0C		1C	0C	1C			
0D		1D	0D	1D			
0E		1E	0E	1E			
0F		1F	0F	1F			

1)

No.	Contents of display
1)	The ON/OFF status of the I/O signal corresponding to the PLC CPU is displayed. The I/O signal is ON when displayed in a reverse display.



12.8.3 Graph monitor

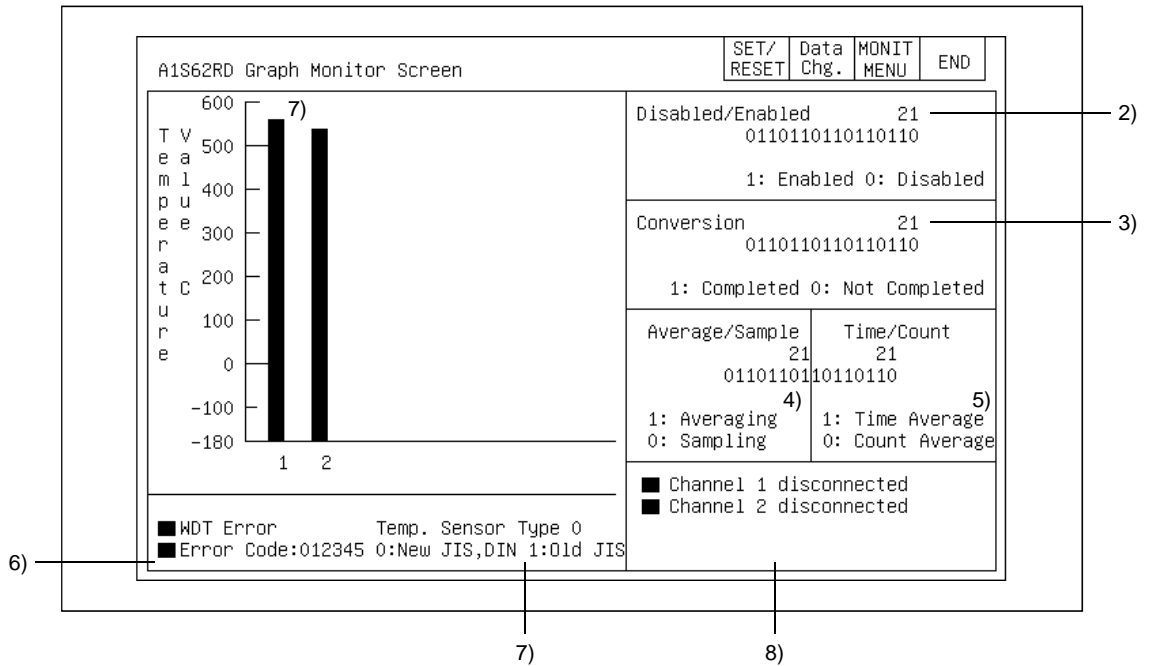

No.	Contents of display	Buffer memory address to reference (decimal)
1)	The temperature detection value of each channel is displayed as a graph.	10, 11
2)	The specified conversion enabled/disabled status for each channel is displayed.	0
3)	The status of the Conversion Complete flag for each channel is displayed.	35
4)	The specified status for the averaging processing/sampling processing of each channel is displayed.	1
5)	The specified status for the averaging processing of each channel is displayed.	1
6)	A "■" is displayed when a watchdog timer error occurs. A "■" is displayed when a writing data error occurs; the channel where it occurred and the error code are displayed.	— 34
7)	The specified status of the platinum temperature sensor that is used is displayed.	36
8)	For A1S62RD3 A "■" is displayed in a channel where a broken wire was detected. For A1S62RD4 A "■" is displayed in CH1 when a broken wire is detected in any channel.	—

12.9 A1S63DA module monitor

12.9.1 Operation monitor

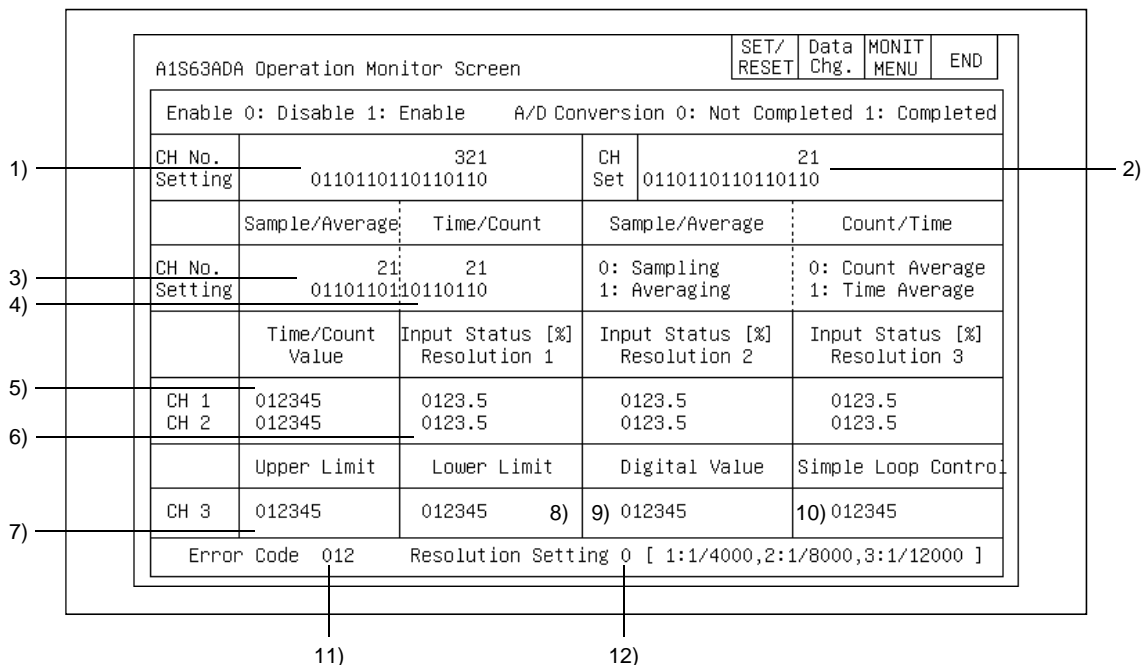

No.	Contents of display	Buffer memory address to reference (decimal)
1)	The specified conversion enabled/disabled status for each channel is displayed.	0
2)	The Conversion Completed flag status for channels 1 and 2 is displayed.	15
3)	The specified status for the averaging processing/sampling processing of channels 1 and 2 is displayed.	1
4)	The specified status for the averaging processing of channels 1 and 2 is displayed.	
5)	The values set for the time and number of times for averaging processing of channels 1 and 2 is displayed.	2, 3
6)	The current output value, a value between 0 to 4000 for the digital output value of channels 1 and 2, is displayed as a percentage ranging from 0 to 100% (Resolution selection: 2: 0 to 8000, 3: 0 to 12000)	11, 12
7)	The upper limit of the digital value following D/A conversion with channel 3 is displayed.	4
8)	The lower limit of the digital value following D/A conversion with channel 3 is displayed.	5
9)	The set value of the digital value following D/A conversion with channel 3 is displayed.	10
10)	The digital value of channel 3 calculated by simple loop control is displayed.	13
11)	The error code is displayed when a writing data error occurs.	16
12)	The set resolution selection is displayed.	14

12.9.2 Simple loop monitor

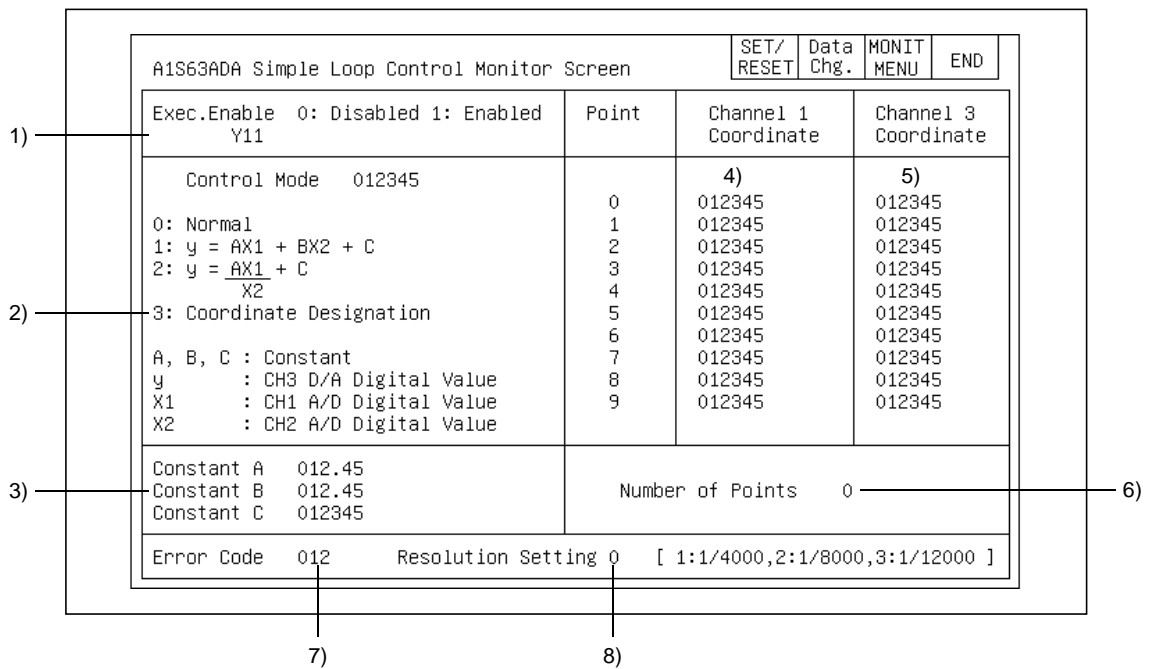

No.	Contents of display	Buffer memory address to reference (decimal)
1)	The specified simple loop control execution enabled/disabled status is displayed.	—
2)	The control mode set status is displayed.	6
3)	The set value of the simple loop control constant is displayed.	7, 8, 9
4)	The set values of channel 1 coordinates that were set in each point are displayed.	18 to 37
5)	The set values of channel 3 coordinates that were set in each point are displayed.	
6)	The number of coordinate points of the simple loop control that was set is displayed.	17
7)	The error code is displayed when a writing data error occurs.	16
8)	The set resolution selection is displayed.	14

12.9.3 I/O monitor

A1S63ADA Input/Output Monitor Screen				SET/ RESET	Data Chg.	MONIT MENU	END
Inputs (X)			Outputs (Y)				
00	WDT Error	10	00	CH3 Output	10	CH3 Output	
01	Conversion READY	11	01	Loop Control	11	Loop Control	
02	Error Detection	12	02	Error Reset	12	Error Reset	
03	CH3 Up Limit	13	03	CH3 Unlimited	13	CH3 Unlimited	
04	CH3 Low Limit	14	04		14		
05	Loop Control	15	05		15		
06		16	06		16		
07		17	07		17		
08	Resolution	18	08	Resol. Selection	18	Resol. Selection	
09	Resolution	19	09	Resol. Selection	19	Resol. Selection	
0A	CH1 Volt./Current	1A	0A	CH1 Volt./Current	1A	CH1 Volt./Current	
0B	CH2 Volt./Current	1B	0B	CH2 Volt./Current	1B	CH2 Volt./Current	
0C	CH3 Volt./Current	1C	0C	CH3 Volt./Current	1C	CH3 Volt./Current	
0D		1D	0D	Offset/Gain Set.	1D	Offset/Gain Set.	
0E		1E	0E		1E		
0F		1F	0F		1F		

1)

No.	Contents of display
1)	The ON/OFF status of the I/O signal corresponding to the PLC CPU is displayed. The I/O signal is ON when displayed in a reverse display.

## 12. OPERATION OF EACH SPECIAL MODULE MONITOR SCREEN

MELSEC GOT

### 12.10 A1S64DA module monitor

#### 12.10.1 Operation monitor

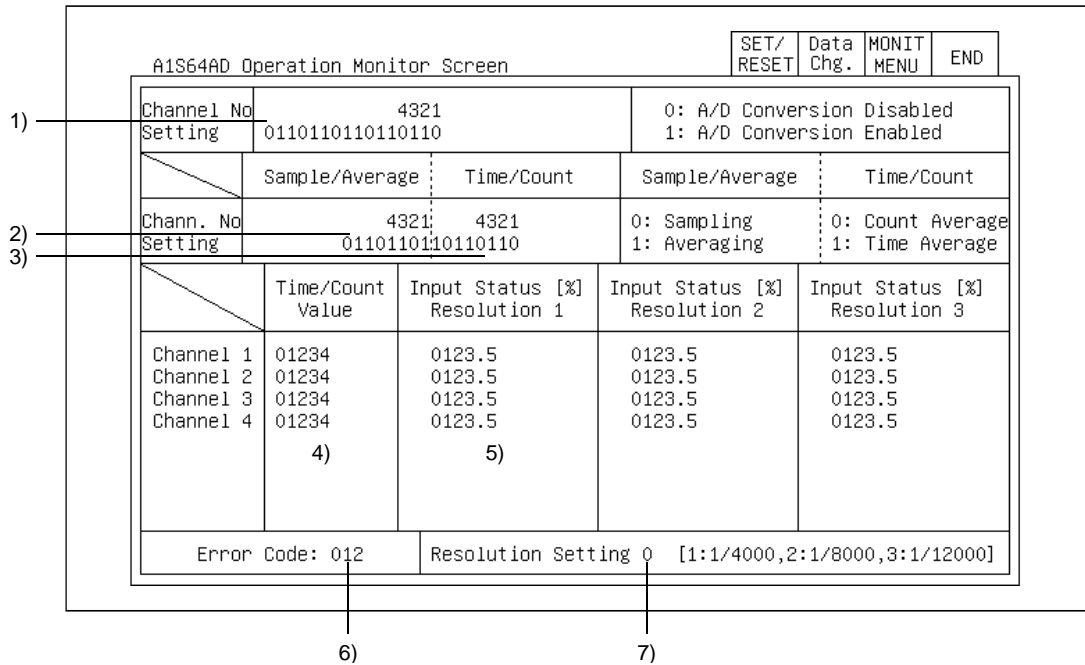

No.	Contents of display	Buffer memory address to reference (decimal)
1)	The specified conversion enabled/disabled status of each channel is displayed.	0
2)	The specified status for the averaging processing/sampling processing of each channel is displayed.	1
3)	The specified status for the averaging processing of each channel is displayed.	1
4)	The values set for the time and number of times for averaging processing of each channel is displayed.	2 to 5
5)	The current output value, a value between 0 to 4000 for the digital output value of each channel, is displayed as a percentage ranging from 0 to 100%. (Resolution selection: 2: 0 to 8000, 3: 0 to 12000)	10 to 13
6)	The error code is displayed when a writing data error occurs.	18
7)	The set resolution selection is displayed.	20

12.10.2 I/O monitor

SET/RESET
Data Chg.
MONIT MENU
END

A1S64AD Input/Output Monitor Screen

Inputs (X)		Outputs (Y)	
00	WDT Error Flag	10	00
01	READY	11	01
02	Error Flag	12	02
03		13	03
04		14	04
05		15	05
06		16	06
07		17	07
08		18	08
09		19	09
0A		1A	0A
0B		1B	0B
0C		1C	0C
0D		1D	0D
0E		1E	0E
0F		1F	0F
			12 Error Reset

1) —

No.	Contents of display
1)	The ON/OFF status of the I/O signal corresponding to the PLC CPU is displayed. The I/O signal is ON when displayed in a reverse display.

12.10.3 Graph monitor

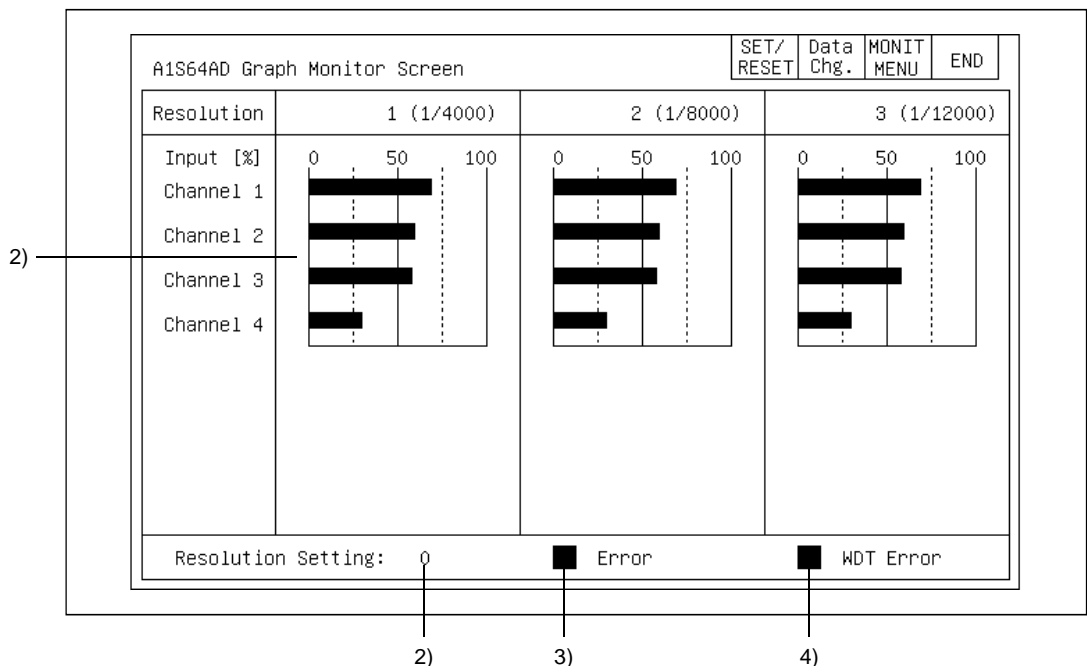

No.	Contents of display	Buffer memory address to reference (decimal)
1)	The current output value, a value between 0 to 4000 for the digital output value of each channel, is displayed in a graph as a percentage ranging from 0 to 100% (Resolution selection: 2: 0 to 8000, 3: 0 to 12000)	10 to 13
2)	The set resolution selection is displayed. 1: 1/4000    2: 1/8000    3: 1/12000	20
3)	A "■" is displayed when a writing data error occurs.	—
4)	A "■" is displayed when a watchdog timer error occurs.	—

12.11 A68AD module monitor

12.11.1 Operation monitor

A68AD Operation Monitor Screen				SET/ RESET	Data Chg.	MONIT MENU	END
	Sample/Average	Time/Count	Sample/Average Count/Time				
1) Channel No.	87654321	87654321	0:Sampling	0:Count Average			
2) Setting	01101101	10110110	1:Averaging	1:Time Average			
	Count/Time Value	Input Status [%]	No. of Channels Used 0				
Channel 1	01234	01234.6	Writing Data Error 01				
Channel 2	01234	01234.6					
Channel 3	01234	01234.6					
Channel 4	01234	01234.6					
Channel 5	01234	01234.6					
Channel 6	01234	01234.6					
Channel 7	01234	01234.6					
Channel 8	01234	01234.6					

No.	Contents of display	Buffer memory address to reference (decimal)
1)	The specified status for the averaging processing/sampling processing of each channel is displayed.	1
2)	The specified status for the averaging processing of each channel is displayed.	1
3)	The values set for the time and number of times for averaging processing of each channel is displayed.	2 to 9
4)	The current output value, a value between 0 to 2000 for the digital output value of each channel, is displayed as a percentage ranging from 0 to 100%.	10 to 17
5)	The number of channels that are used is displayed. (With A68AD-S2 monitoring, the display value is invalid.)	0
6)	The error code is displayed when a writing data error occurs.	34



## 12. OPERATION OF EACH SPECIAL MODULE MONITOR SCREEN

MELSEC GOT

### 12.11.2 I/O monitor

A68AD Input/Output Monitor Screen

		Inputs (X)			Outputs (Y)
	00	HDT Error	10		00
1) →	01	READY	11		01
	02		12		02
	03		13		03
	04		14		04
	05		15		05
	06		16		06
	07		17		07
	08		18		08
	09		19		09
	0A		1A		0A
	0B		1B		0B
	0C		1C		0C
	0D		1D		0D
	0E		1E		0E
	0F		1F		0F

SET/ RESET	Data Chg.	MONIT MENU	END
---------------	--------------	---------------	-----

No.	Contents of display
1)	The ON/OFF status of the I/O signal corresponding to the PLC CPU is displayed. The I/O signal is ON when displayed in a reverse display.

## 12. OPERATION OF EACH SPECIAL MODULE MONITOR SCREEN MELSEC GOT

### 12.11.3 Graph monitor

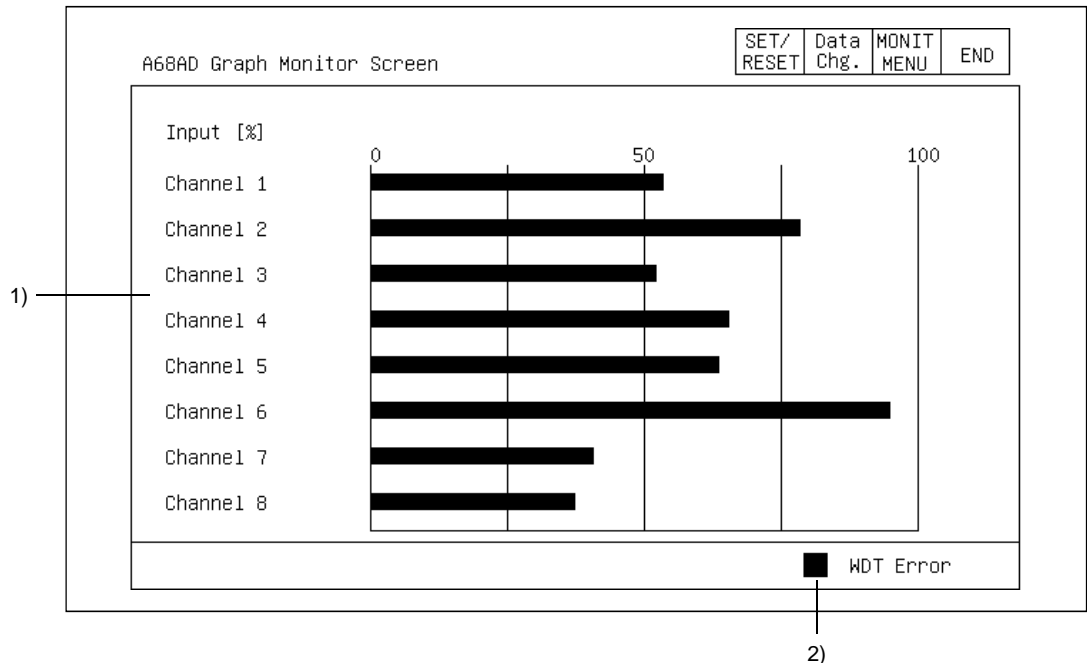

No.	Contents of display	Buffer memory address to reference (decimal)
1)	The current output value, a value between 0 to 2000 for the digital output value of each channel, is displayed in a graph as a percentage ranging from 0 to 100%	10 to 17
2)	A "■" is displayed when a watchdog timer error occurs.	—

## 12. OPERATION OF EACH SPECIAL MODULE MONITOR SCREEN

MELSEC GOT

### 12.12 A1S68AD module monitor

#### 12.12.1 Operation monitor

A1S68AD		Movement Monitor Screen		SET/ RESET	Data Chg.	MONIT MENU	END
	C H	8 7 6 5 4 3 2 1					
1)	A/D Conversion	0 1 1 0 1 1 0 1	0 : Disabled	1 : Enabled			
2)	A/D Method	0 1 1 0 1 1 0 1	0 : Sampling	1 : Averaging			
3)	Averaging	0 1 1 0 1 1 0 1	0 : Number	1 : Time			
4)	A/D Conversion	0 1 1 0 1 1 0 1	0 : Incomplete	1 : Complete			
		Averaging Time/Number	Input Status [%]				
	CH 1	0 1 2 3 4	0 1 2 3 4 . 6				
	CH 2	0 1 2 3 4	0 1 2 3 4 . 6				
	CH 3	0 1 2 3 4	0 1 2 3 4 . 6				
	CH 4	0 1 2 3 4	0 1 2 3 4 . 6				
	CH 5	5) 0 1 2 3 4	6) 0 1 2 3 4 . 6				
	CH 6	0 1 2 3 4	0 1 2 3 4 . 6				
	CH 7	0 1 2 3 4	0 1 2 3 4 . 6				
	CH 8	0 1 2 3 4	0 1 2 3 4 . 6				
			Error Code		0 1 2		

7)

No.	Contents of display	Buffer memory address to reference (decimal)
1)	The A/D conversion enabled/disabled status of each channel is displayed.	0
2)	The specified status for the averaging processing/sampling processing of each channel is displayed.	2
3)	The specified status for the averaging processing of each channel (Time/count) is displayed.	2
4)	The A/D Conversion Complete flag status for each channel is displayed.	28
5)	The values set for the time and count of times for averaging processing of each channel is displayed.	10 to 17
6)	The current output value, a value between 0 to 2000 for the digital output value of each channel, is displayed as a percentage ranging from 0 to 100%.	20 to 27
7)	The error code is displayed when a writing data error occurs.	1

## 12. OPERATION OF EACH SPECIAL MODULE MONITOR SCREEN

MELSEC GOT

### 12.12.2 I/O monitor

A1S68AD		Input/Output Monitor Screen		SET/ RESET	Data Chg.	MONIT MENU	END	
				X	Y			
00	WDT Error	10		00		10		
01	Ready	11		01		11		
02	Error Detect	12		02		08	Error Reset	
03		13		03		13		
04		14		04		14		
05		15		05		15		
06		16		06		16		
07		17		07		17		
08		18		08		18		
09		19		09		19		
0A		1A		0A		1A		
0B		1B		0B		1B		
0C		1C		0C		1C		
0D		1D		0D		1D		
0E		1E		0E		1E		
0F		1F		0F		1F		

1) —

No.	Contents of display
1)	The ON/OFF status of the I/O signal corresponding to the PLC CPU is displayed. The I/O signal is ON when displayed in a reverse display.

## 12. OPERATION OF EACH SPECIAL MODULE MONITOR SCREEN MELSEC GOT

### 12.12.3 Graph monitor

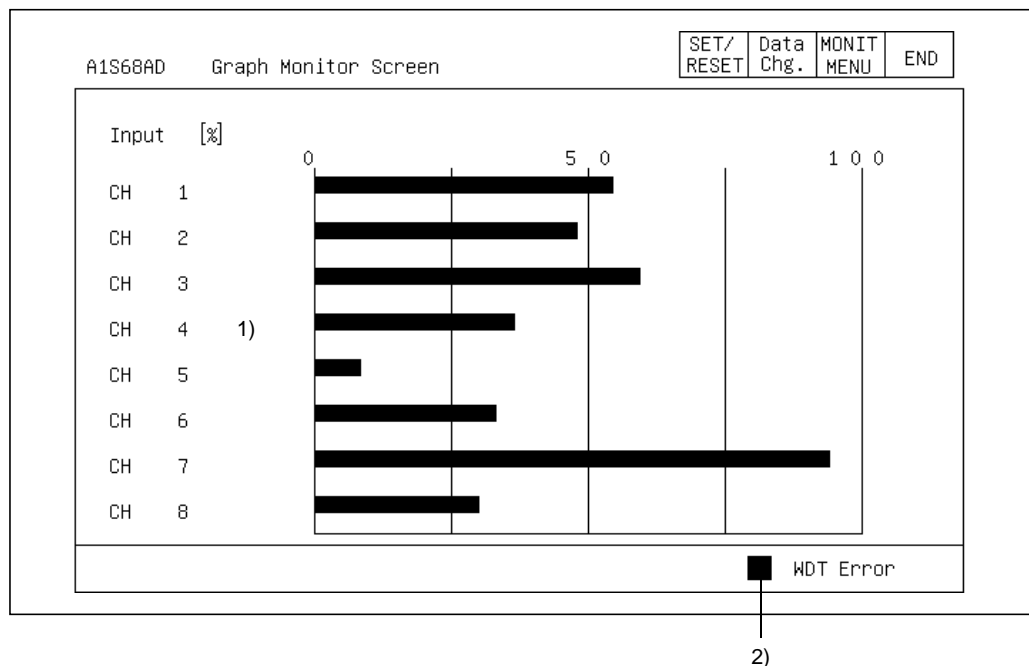

No.	Contents of display	Buffer memory address to reference (decimal)
1)	The current output value, a value between 0 to 2000 for the digital output value of each channel, is displayed in a graph as a percentage ranging from 0 to 100%	20 to 27
2)	A "■" is displayed when a watchdog timer error occurs.	—

## 12. OPERATION OF EACH SPECIAL MODULE MONITOR SCREEN

MELSEC GOT

### 12.13 A68ADN module monitor

#### 12.13.1 Operation monitor

A68ADN Operation Monitor Screen					SET/ RESET	Data Chg.	MONIT MENU	END
1)	Channel Setting	87654321 0110110110110110		0:Disabled		1:Enabled		
		Sample/Average	Count/Time	Sample/Average	Count/Time			
2)	Channel Setting	87654321 0110110110110110		0:Sampling		0:Count Average		
3)				1:Averaging		1:Time Average		
		Count/Time Value	Input Status [%] Resolution 1	Input Status [%] Resolution 2	Input Status [%] Resolution 3			
	Channel 1	01234	0123.5	0123.5	0123.5			
	Channel 2	01234	0123.5	0123.5	0123.5			
	Channel 3	01234	0123.5	0123.5	0123.5			
	Channel 4	01234	0123.5	0123.5	0123.5			
	Channel 5	01234	0123.5	0123.5	0123.5			
	Channel 6	01234	0123.5	0123.5	0123.5			
	Channel 7	01234	0123.5	0123.5	0123.5			
	Channel 8	01234	0123.5	0123.5	0123.5			
	Error Code	012		Resolution Selection 0 [1:1/4000,2:1/8000,3:1/12000]				
		6)		7)				

No.	Contents of display	Buffer memory address to reference (decimal)
1)	The specified conversion enabled/disabled status of each channel is displayed.	0
2)	The specified status for the averaging processing/sampling processing of each channel is displayed.	1
3)	The specified status for the averaging processing of each channel is displayed.	1
4)	The values set for the time and count of times for averaging processing of each channel is displayed.	2 to 9
5)	The current output value, a value between 0 to 4000 for the digital output value of each channel, is displayed as a percentage ranging from 0 to 100%. (Resolution selection: 2: 0 to 8000, 3: 0 to 12000)	10 to 17
6)	The error code is displayed when a writing data error occurs.	18
7)	The resolution selection that was set is displayed.	20

## 12. OPERATION OF EACH SPECIAL MODULE MONITOR SCREEN

MELSEC GOT

### 12.13.2 I/O monitor

A68ADN Input/Output Monitor Screen

		Inputs (X)			Outputs (Y)
	00	WDT Error	10		00
	01	READY	11		01
1)	02	Error	12		02
	03		13		03
	04		14		04
	05		15		05
	06		16		06
	07		17		07
	08		18		08
	09		19		09
	0A		1A		0A
	0B		1B		0B
	0C		1C		0C
	0D		1D		0D
	0E		1E		0E
	0F		1F		0F
					12
					Error Reset

No.	Contents of display
1)	The ON/OFF status of the I/O signal corresponding to the PLC CPU is displayed. The I/O signal is ON when displayed in a reverse display.

## 12. OPERATION OF EACH SPECIAL MODULE MONITOR SCREEN

MELSEC GOT

### 12.13.3 Graph monitor

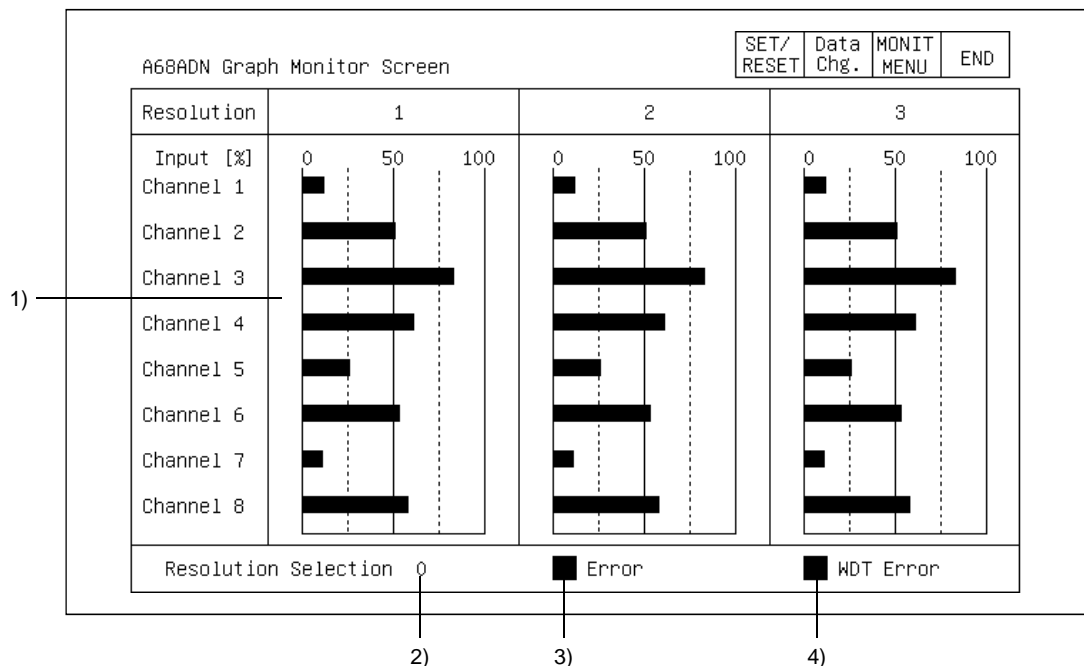

No.	Contents of display	Buffer memory address to reference (decimal)
1)	The current output value, a value between 0 to 4000 for the digital output value of each channel, is displayed as a percentage ranging from 0 to 100%. (Resolution selection: 2: 0 to 8000, 3: 0 to 12000)	10 to 17
2)	The set resolution selection is displayed. 1: 1/4000    2: 1/8000    3: 1/12000	20
3)	A "■" is displayed when a writing data error occurs.	—
4)	A "■" is displayed when a watchdog timer error occurs.	—



## 12. OPERATION OF EACH SPECIAL MODULE MONITOR SCREEN

MELSEC GOT

### 12.14 A68RD module monitor

#### 12.14.1 Operation monitor

A68RD Operation Monitor Screen				SET/ RESET	Data Chg.	MONIT MENU	END
	Temp. Value (16 bits)	Temp. Value (32 bits)	Time/ Count	Disabled/Enabled 87654321 0110110110110110			
1	0123.5 1)	0123.567 2)	3)01234	1: Enabled 0: Disabled			
2	0123.5	0123.567	01234	Conversion 87654321 0110110110110110			
3	0123.5	0123.567	01234	1: Completed 0: Not Completed			
4	0123.5	0123.567	01234	Average/Sample Time/Count 8765432187654321 0110110110110110			
5	0123.5	0123.567	01234	6) 7)			
6	0123.5	0123.567	01234	1: Averaging 1: Time Average 0: Sampling 0: Count Average			
7	0123.5	0123.567	01234	■ CH1 disconn. ■ CH5 disconn. ■ CH2 disconn. ■ CH6 disconn. ■ CH3 disconn. ■ CH7 disconn. ■ CH4 disconn. ■ CH8 disconn.			
8	0123.5	0123.567	01234	■ WDT Error Temp. Sensor Type 0 ■ Error Code:012345 0:New JIS,DIN 1:Old JIS			

No.	Contents of display	Buffer memory address to reference (decimal)
1)	The temperature detection value of each channel is displayed up to 1 digit after the decimal point.	10 to 17
2)	The temperature detection value of each channel is displayed up to 3 digits after the decimal point.	18 to 33
3)	The values set for the time and count of times for averaging processing of each channel is displayed.	2 to 9
4)	The specified conversion enabled/disabled status of each channel is displayed.	0
5)	The conversion complete flag status for each channel is displayed.	35
6)	The specified status for the averaging processing/sampling processing of each channel is displayed.	1
7)	The specified status for the averaging processing of each channel is displayed.	1
8)	A "■" is displayed when a watchdog timer error occurs.	—
	A "■" is displayed when a writing data error occurs; the channel where it occurred and the error code are displayed.	34
9)	The specified status of the platinum temperature sensor that is used is displayed.	36
10)	For A68RD3 A "■" is displayed in a channel where a broken wire was detected. For A68RD4 A "■" is displayed in CH1 when a broken wire is detected in any channel.	—

## 12. OPERATION OF EACH SPECIAL MODULE MONITOR SCREEN

MELSEC GOT

### 12.14.2 I/O monitor

A68RD Input/Output Monitor Screen

Inputs (X)		Outputs (Y)	
00	WDT Error	10	00
01	READY	11	01
02	Write Data Error	12	02
03	CH1 Disconnected	13	03
04	CH2 Disconnected	14	04
05	CH3 Disconnected	15	05
06	CH4 Disconnected	16	06
07	CH5 Disconnected	17	07
08	CH6 Disconnected	18	08
09	CH7 Disconnected	19	09
0A	CH8 Disconnected	1A	0A
0B		1B	0B
0C		1C	0C
0D		1D	0D
0E		1E	0E
0F		1F	0F

SET/ RESET	Data Chg.	MONIT MENU	END
---------------	--------------	---------------	-----

1) →

No.	Contents of display
1)	The ON/OFF status of the I/O signal corresponding to the PLC CPU is displayed. The I/O signal is ON when displayed in a reverse display.

## 12. OPERATION OF EACH SPECIAL MODULE MONITOR SCREEN

MELSEC GOT

### 12.14.3 Graph monitor

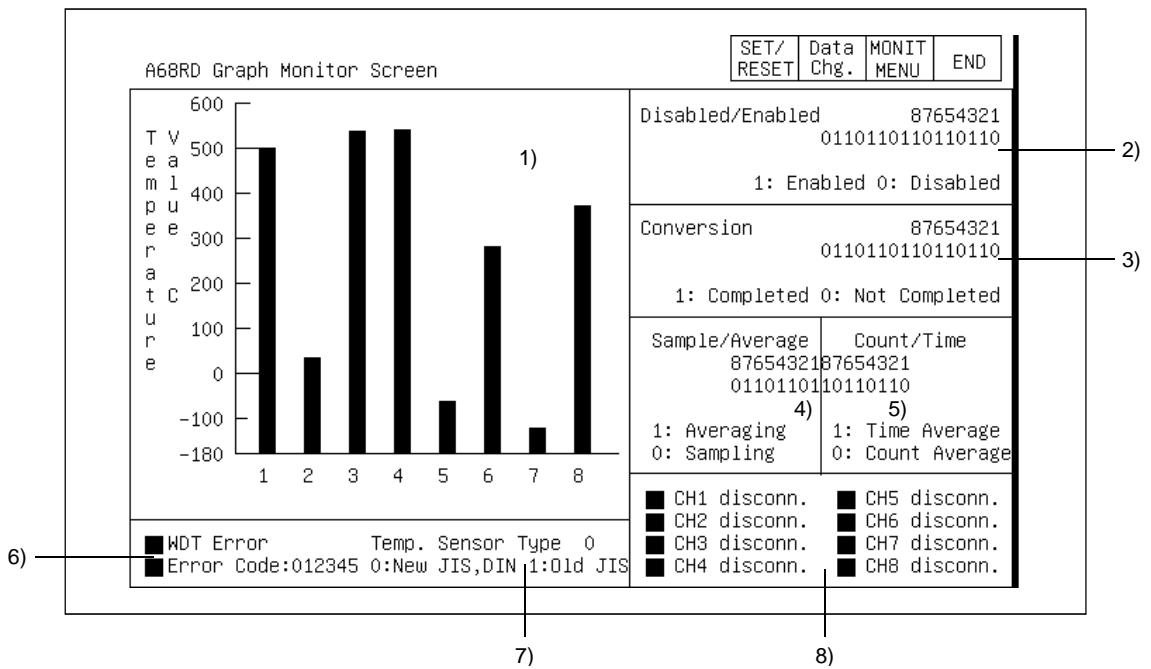

No.	Contents of display	Buffer memory address to reference (decimal)
1)	The temperature detection value of each channel is displayed in a graph.	10 to 17
2)	The specified conversion enabled/disabled status of each channel is displayed.	0
3)	The conversion complete flag status for each channel is displayed..	35
4)	The specified status for the averaging processing/sampling processing of each channel is displayed.	1
5)	The specified status for the averaging processing of each channel is displayed.	1
6)	A "■" is displayed when a watchdog timer error occurs.	—
	A "■" is displayed when a writing data error occurs; the channel where it occurred and the error code are displayed.	34
7)	The specified status of the platinum temperature sensor that is used is displayed.	36
8)	For A68RD3 A "■" is displayed in a channel where a broken wire was detected.	—
	For A68RD4 A "■" is displayed in CH1 when a broken wire is detected in any channel.	

12.15 A1S68DAI, A1S68DAV module monitor

The contents displayed on each monitor of the A1S68DAI module and A1S68DAV module are nearly identical, except for the sections displaying the module format. The A1S68DAV module monitor screen is used as an example in each of the following sections.

12.15.1 Operation monitor

A1S68DAV Movement Monitor Screen		SET/ RESET	Data Chg.	MONIT MENU	END
C	H	8 7 6 5 4 3 2 1			
Analog Output		01101101			
		0 : Enabled			
		1 : Disabled			
		Output Status	[%]	Up Limit	Low Limit
CH	1	012345.7		0	0
CH	2	012345.7		0	0
CH	3	012345.7		0	0
CH	4	012345.7		0	0
CH	5	012345.7		0	0
CH	6	012345.7		0	0
CH	7	012345.7		0	0
CH	8	012345.7		0	0
Up/Low Limit		0 : OK		1 : Error	

No.	Contents of display	Buffer memory address to reference (decimal)
1)	The analog output enabled/disabled status for each channel is displayed.	0
2)	For A1S68DAI: The present input value, a value between 0 to 4000 for the digital input value of each channel, is displayed as a percentage ranging from 0 to 100%. For A1S68DAV: The present input value, a value between -2000 to 2000 for the digital input value of each channel, is displayed as a percentage ranging from 0 to 100%.	1 to 8
3)	When the digital input value set for each channel is greater than the allowable value, "1" is displayed.	10 to 17
4)	When the digital input value set for each channel is less than the allowable value, "1" is displayed.	10 to 17

## 12. OPERATION OF EACH SPECIAL MODULE MONITOR SCREEN

MELSEC GOT

### 12.15.2 I/O monitor

A1S68DAV Input/Output Monitor Screen

X			Y		
00	WDT Error	10	00	CH1 Enable	10
01	Ready	11	01	CH2 Enable	11
02	Error Detect	12	02	CH3 Enable	12
03		13	03	CH4 Enable	13
04		14	04	CH5 Enable	14
05		15	05	CH6 Enable	15
06		16	06	CH7 Enable	16
07		17	07	CH8 Enable	17
08		18	08	Error Reset	18
09		19	09		19
0A		1A	0A		1A
0B		1B	0B		1B
0C		1C	0C		1C
0D		1D	0D		1D
0E		1E	0E		1E
0F		1F	0F		1F

SET/ RESET	Data Chg.	MONIT MENU	END
---------------	--------------	---------------	-----

1) →

No.	Contents of display
1)	The ON/OFF status of the I/O signal corresponding to the PLC CPU is displayed. The I/O signal is ON when displayed in a reverse display.

12.15.3 Graph monitor

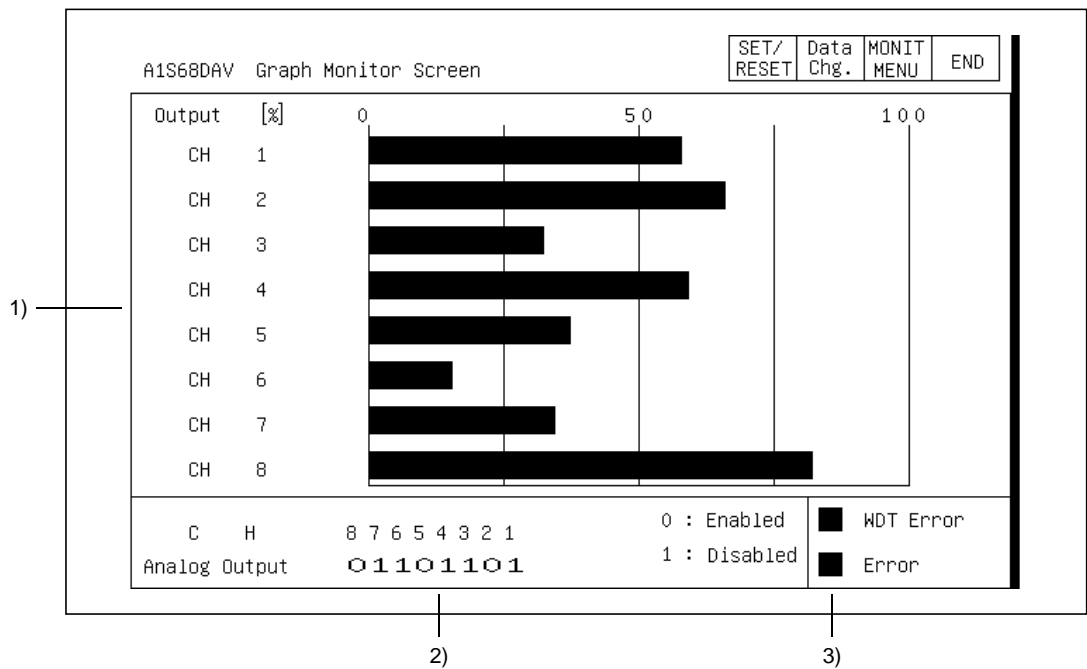

No.	Contents of display	Buffer memory address to reference (decimal)
1)	For A1S68DAI: The present input value, a value between 0 to 4000 for the digital input value of each channel, is displayed in a graph as a percentage ranging from 0 to 100%. For A1S68DAV: The present input value, a value between -2000 to 2000 for the digital input value of each channel, is displayed in a graph as a percentage ranging from 0 to 100%.	1 to 8
2)	The analog output enabled/disabled status for each channel is displayed.	0
3)	A "■" is displayed when a watchdog timer error occurs. When the digital input value set for each channel is greater than/ less than the allowable value, a "■" is displayed.	— 10 to 17

## 12. OPERATION OF EACH SPECIAL MODULE MONITOR SCREEN

MELSEC GOT

### 12.16 A616AD module monitor

#### 12.16.1 Operation monitor

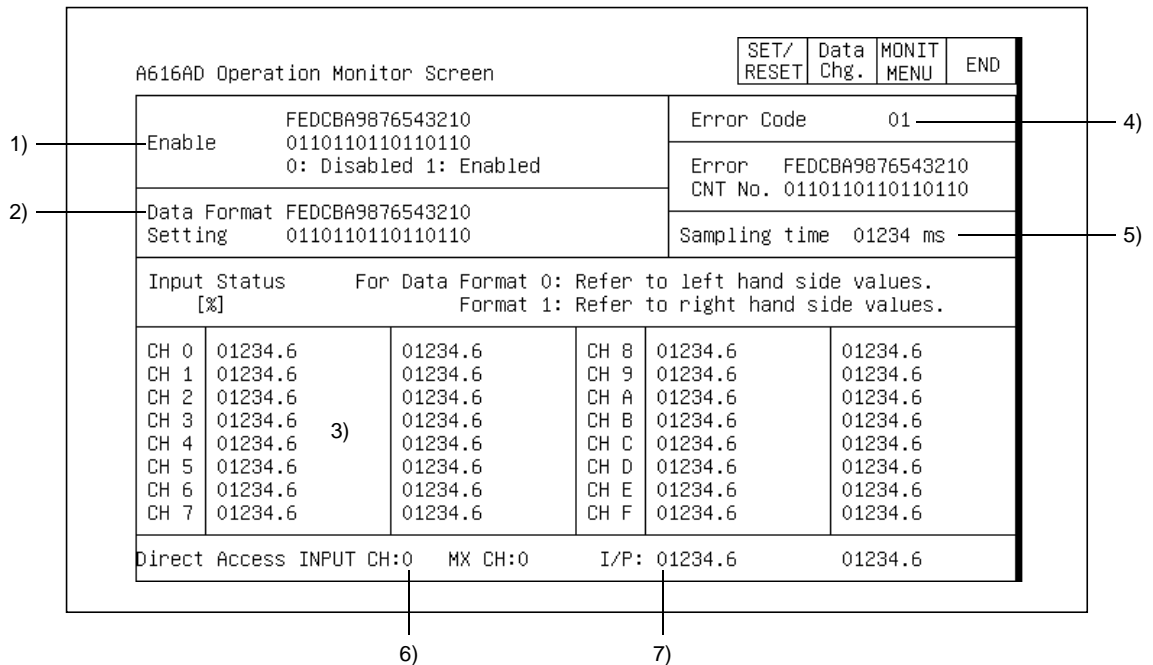

No.	Contents of display	Buffer memory address to reference (hexadecimal)
1)	The specified conversion enabled/disabled status of each channel is displayed.	F
2)	The set status of the data format for each channel is displayed. 0: Data format 48-4047 1: Data format 2048-2047	4
3)	The current output value, a value between 0 to 4000 for the digital output value of each channel, is displayed as a percentage ranging from 0 to 100%.	30 to 3F
4)	The error code is displayed when an error occurs.	5
5)	The set value of the sampling period is displayed.	3
6)	The channels where direct access occurs are displayed.	0
7)	The current output value, a value between 0 to 4000 for the digital output value for each channel where direct access occurs, is displayed as a percentage ranging from 0 to 100%.	2

## 12. OPERATION OF EACH SPECIAL MODULE MONITOR SCREEN

MELSEC GOT

### 12.16.2 Operation monitor (connect No. 0 to connect No. 7 when multiplex module is used)

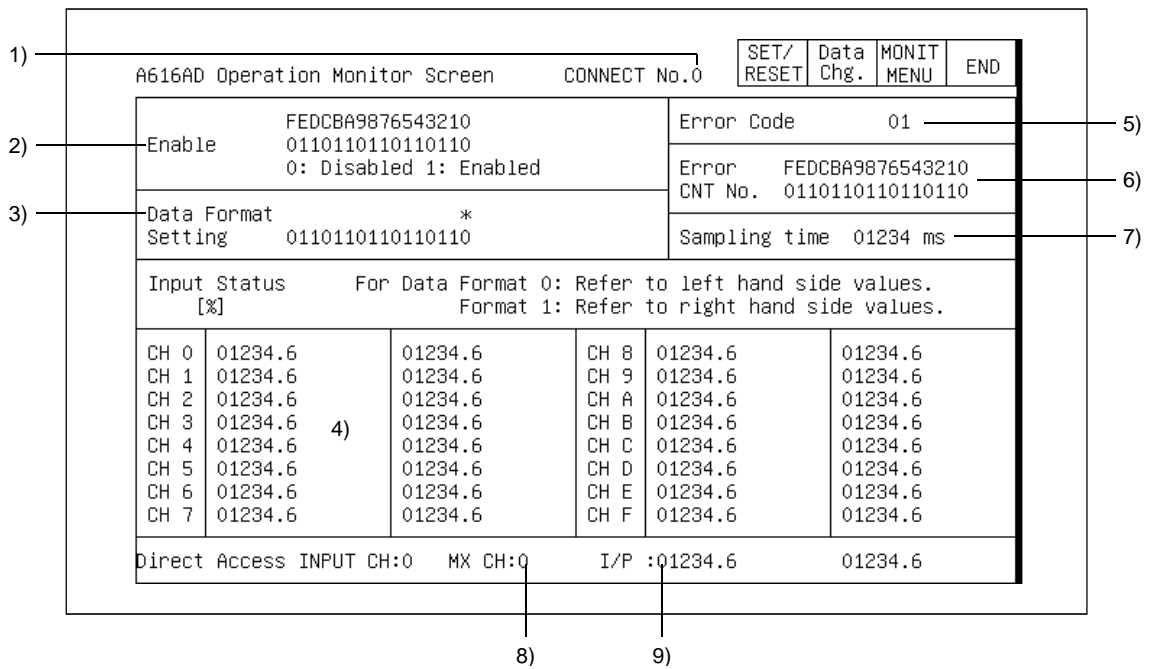

No.	Contents of display	Buffer memory address to reference (hexadecimal)
1)	The connect number of the monitor being used is displayed.	—
2)	The specified conversion enabled/disabled status of each channel is displayed.	10 to 17
3)	The set status of the data format for each channel is displayed. 0: Data format 48-4047 1: Data format 2048-2047	4
4)	The current output value, a value between 0 to 4000 for the digital output value of each channel, is displayed as a percentage ranging from 0 to 100%.	100 to 17F
5)	The error code is displayed when an error occurs.	5
6)	"1" is displayed when an error with error code 01 to 03 occurs for any channel.	6
7)	The set value of the sampling period is displayed.	3
8)	The channels where direct access occurs are displayed.	1
9)	The current output value, a value between 0 to 4000 for the digital output value for each channel where direct access occurs, is displayed as a percentage ranging from 0 to 100%.	2



## 12. OPERATION OF EACH SPECIAL MODULE MONITOR SCREEN

MELSEC GOT

### 12.16.3 I/O monitor

A616AD Input/Output Monitor Screen

		Inputs (X)		Outputs (Y)	
	00	WDT Error	10	00	10
	01	READY	11	01	11
1)	02	Error	12	02	12
	03		13	03	13
	04		14	04	14
	05		15	05	15
	06		16	06	16
	07		17	07	17
	08		18	08	18 Direct Access
	09		19	09	19
	0A		1A	0A	1A
	0B		1B	0B	1B
	0C		1C	0C	1C
	0D		1D	0D	1D
	0E		1E	0E	1E
	0F		1F	0F	1F

SET/ RESET	Data Chg.	MONIT MENU	END
---------------	--------------	---------------	-----

No.	Contents of display
1)	The ON/OFF status of the I/O signal corresponding to the PLC CPU is displayed. The I/O signal is ON when displayed in a reverse display.

12.16.4 Graph monitor

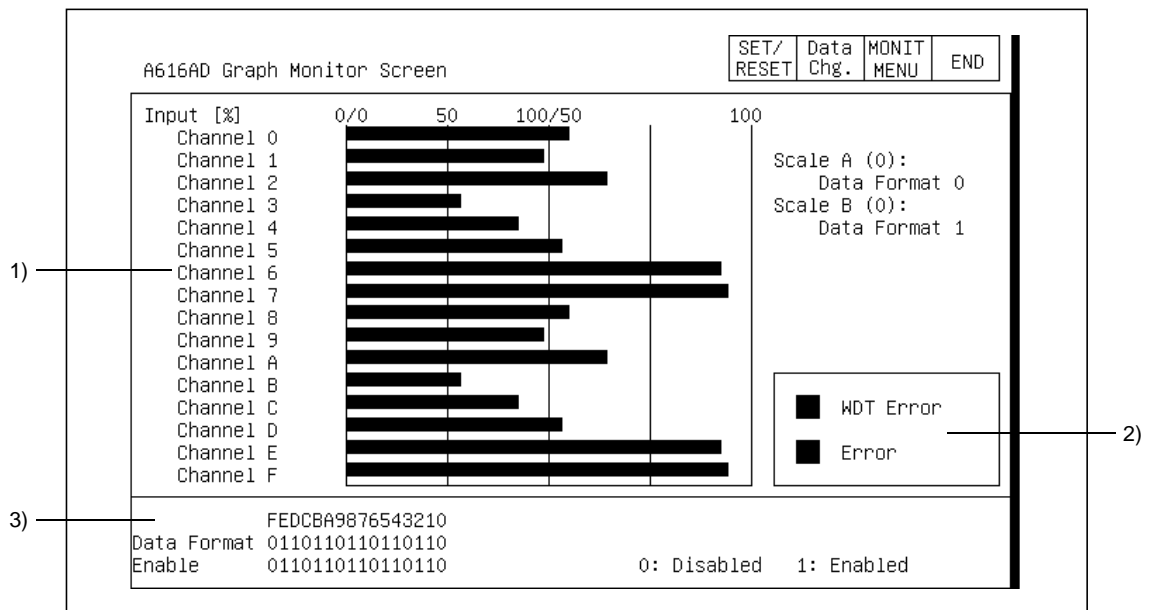

No.	Contents of display	Buffer memory address to reference (hexadecimal)
1)	The current output value, a value between 0 to 4000 for the digital output value of each channel, is displayed as a percentage ranging from 0 to 100%.	30 to 3F
2)	A "■" is displayed when watchdog timer error occurs.	—
	A "■" is displayed when an error occurs.	—
3)	The set status of the data format for each channel is displayed.	4
	The specified conversion enabled/disabled status of each channel is displayed.	F

## 12. OPERATION OF EACH SPECIAL MODULE MONITOR SCREEN

MELSEC GOT

### 12.16.5 Graph monitor (connect No. 0 to connect No. 7 when multiplex module is used)

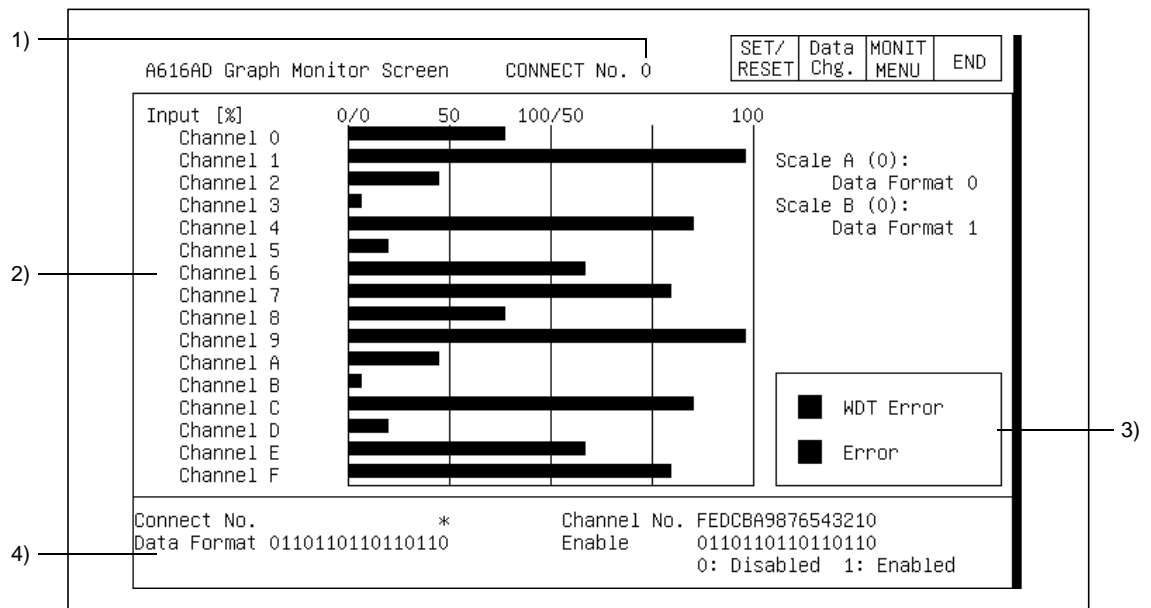

No.	Contents of display	Buffer memory address to reference (hexadecimal)
1)	The connect number of the monitor being used is displayed.	—
2)	The current output value, a value between 0 to 4000 for the digital output value of each channel, is displayed in a graph as a percentage ranging from 0 to 100%.	100 to 17F
3)	A "■" is displayed when watchdog timer error occurs.	—
	A "■" is displayed when an error occurs.	—
4)	The set status of the data format for each channel is displayed.	4
	The specified conversion enabled/disabled status of each channel is displayed.	10 to 17

## 12. OPERATION OF EACH SPECIAL MODULE MONITOR SCREEN

MELSEC GOT

### 12.17 A616DAI, A616DAV module monitor

The contents displayed on each monitor of the A616DAI module and A616DAV module are nearly identical, except for the sections displaying the module format.

The A616DAI module monitor screen is used as an example in each of the following sections.

#### 12.17.1 Operation monitor

A616DAI Operation Monitor Screen								SET/ RESET	Data Chg.	MONIT MENU	END
Channel No. FEDCBA9876543210											
D/A Conversion 0110110110110110								0: Disabled			
Output Enable 0110110110110110								1: Enabled			
		Output [%]	Over Error	Under Error		Output [%]	Over Error	Under Error			
CH 0		012345.7	0	0	CH 8	012345.7	0	0	3)		
CH 1		012345.7	0	0	CH 9	012345.7	0	0	4)		
CH 2		012345.7	0	0	CH A	012345.7	0	0			
CH 3		012345.7	0	0	CH B	012345.7	0	0			
CH 4		012345.7	0	0	CH C	012345.7	0	0			
CH 5		012345.7	0	0	CH D	012345.7	0	0			
CH 6		012345.7	0	0	CH E	012345.7	0	0			
CH 7		012345.7	0	0	CH F	012345.7	0	0			
Over/Under Error			0: Normal		1: Error						

No.	Contents of display	Buffer memory address to referende (hexadecimal)
1)	The set D/A conversion enabled/disabled status for each channel is displayed.	0
	The set analog output enabled/disabled status for each channel is displayed.	1
2)	The current input value, a value between 0 to 4000 for the digital input value of each channel, is displayed as a percentage ranging from 0 to 100%.	10 to 1F
3)	When the digital input value for any channel is set to 4096 or higher, "1" is displayed in the over error column.	30 to 3F
4)	For A616DAI: When the digital input value for any channel is set as a negative number, "1" is displayed in the under error column.	30 to 3F
	For A616DAV: When the digital input value for any channel is set to 4097 or less, "1" is displayed in the under error column.	

## 12. OPERATION OF EACH SPECIAL MODULE MONITOR SCREEN

MELSEC GOT

### 12.17.2 I/O monitor

A616DAI Input/Output Monitor Screen

		Inputs (X)			Outputs (Y)
	00	WDT Error	10	00	10
	01	READY	11	01	11
1)	02	Error	12	02	12
	03		13	03	13
	04		14	04	14
	05		15	05	15
	06		16	06	16
	07		17	07	17
	08		18	08	18
	09		19	09	19
	0A		1A	0A	1A
	0B		1B	0B	1B Output Enable
	0C		1C	0C	1C
	0D		1D	0D	1D
	0E		1E	0E	1E
	0F		1F	0F	1F

No.	Contents of display
1)	The ON/OFF status of the I/O signal corresponding to the PLC CPU is displayed. The I/O signal is ON when displayed in a reverse display.

12.17.3 Graph monitor

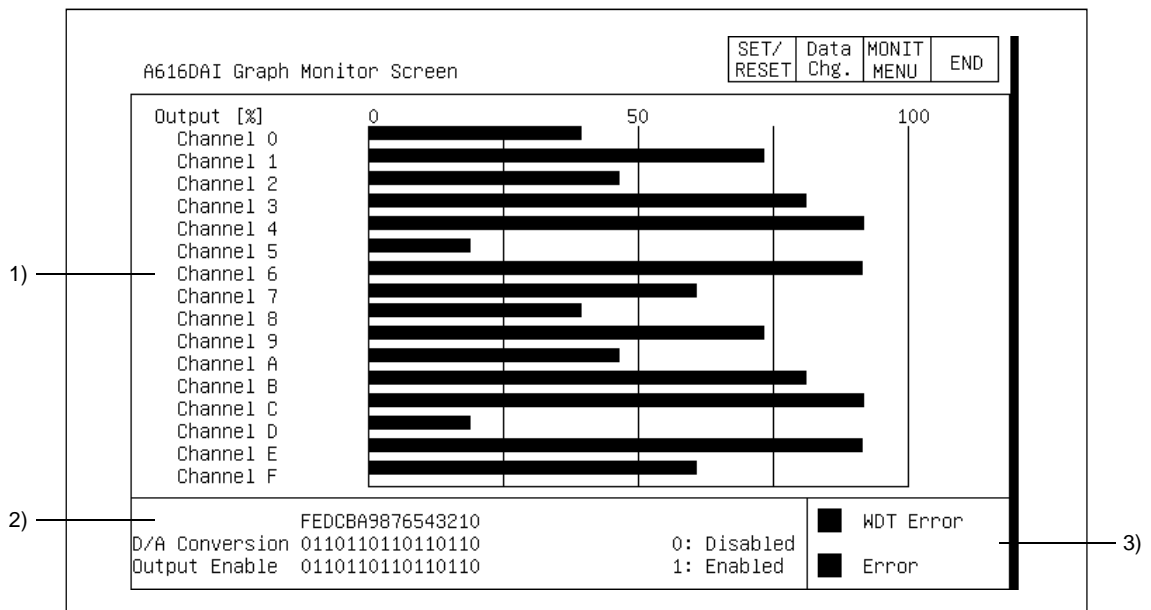

No.	Contents of display	Buffer memory address to reference (hexadecimal)
1)	The current input value, a value between 0 to 4000 for the digital input value of each channel, is displayed in a graph as a percentage ranging from 0 to 100%.	10 to 1F
2)	The set D/A conversion enabled/disabled status for each channel is displayed.	0
	The set analog output enabled/disabled status for each channel is displayed.	1
3)	A "■" is displayed when a watchdog timer error occurs.	—
	For A616DAI: A "■" is displayed when the digital input value of any channel is set to 4096 or higher, or to a negative number. For A616DAV: A "■" is displayed when the digital input value of any channel is set to 4096 or higher, or to -4097 or lower.	—

12.18 A616TD module monitor

12.18.1 Operation monitor (INPUT 0-F)

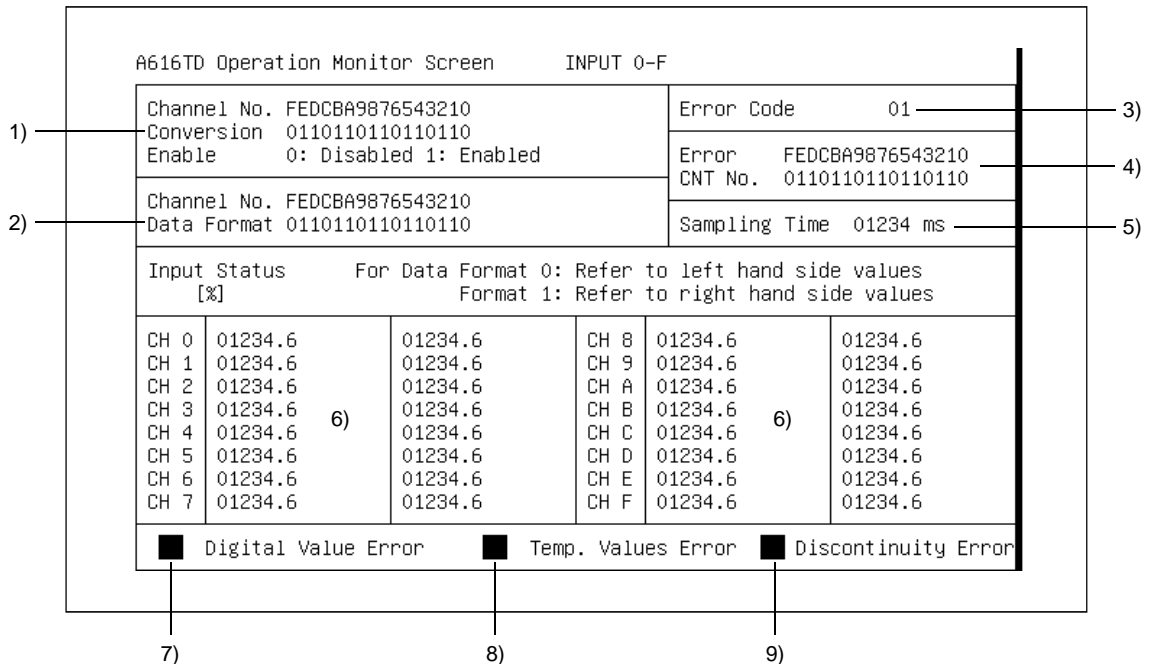

No.	Contents of display	Buffer memory address to reference (hexadecimal)
1)	The specified D/A conversion enabled/disabled status for each channel is displayed.	F
2)	The set status of the data format for each channel is displayed.	0
3)	An error code is displayed when an error occurs.	1
4)	"1" is displayed for CNT No. when an error with error code 01 to 04 has occurred due to a malfunction of the A60MXT unit or a setting error.	2
5)	"0" is displayed for the sampling period current value.	4
6)	For a channel not connected to the A60MX[ ], the current output value, a value between 0 to 4000 for the digital output of that channel, is displayed as a percentage ranging from 0 to 100%. When a channel is connected to the A60MX[ ], the above is displayed for the digital output value for CH0 of A60MX[ ].	70 to 7F
7)	When the A60MXT is used, "■" is displayed when a temperature was input that exceeds the temperature range set according to the digital output value set for each channel.	—
8)	When the A60MXT is used, "■" is displayed when a temperature was input that exceeds the measurement temperature range set for the measurement range of each channel.	—
9)	When the A60MXT is used, "■" is displayed when broken wire is detected in the thermocouple or the compensating lead wire.	—

## 12. OPERATION OF EACH SPECIAL MODULE MONITOR SCREEN

MELSEC GOT

### 12.18.2 Operation monitor (connect No. 0 to connect No. 7 when multiplex module is used)

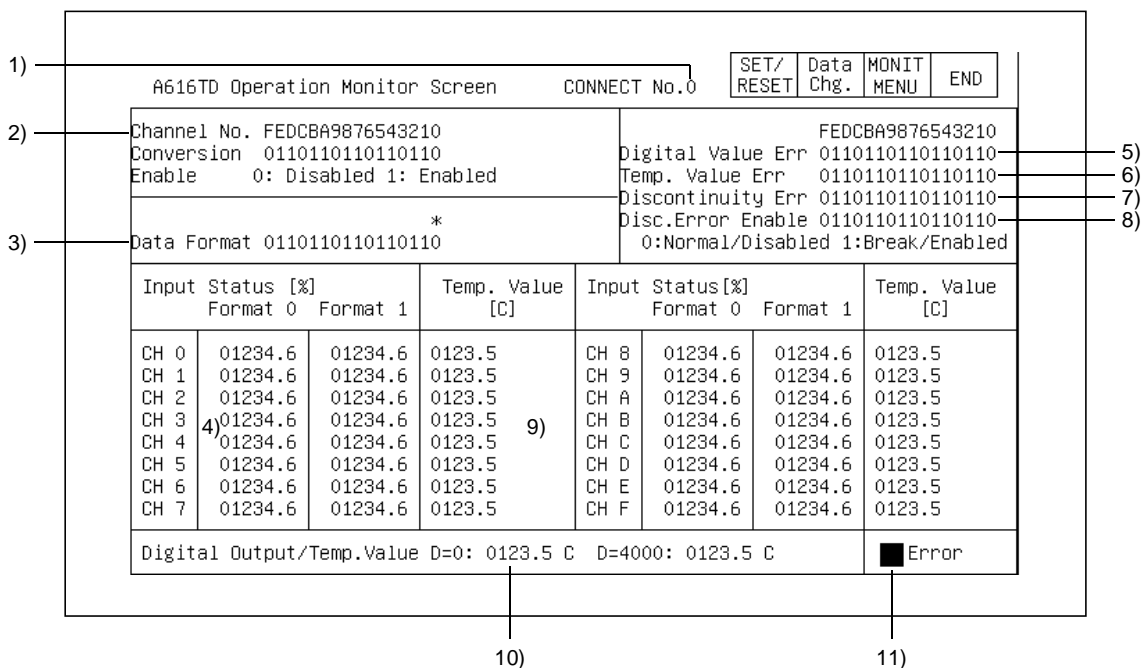

No.	Contents of display	Buffer memory address to reference (hexadecimal)
1)	The connect number of the monitor being used is displayed.	—
2)	The specified conversion enabled/disabled status for each channel is displayed.	10 to 17
3)	The set status of the data format for each channel is displayed. 0: Data format 48-4047 1: Data format 2048-4047	0
4)	The current output value, a value between 0 to 4000 for the digital output value of each channel, is displayed as a percentage ranging from 0 to 100%.	180 to 1FF
5)	When the A60MXT is used, "1" is displayed when a temperature was input that exceeds the temperature range set according to the digital output value set for each channel.	50 to 57
6)	When the A60MXT is used, "1" is displayed when a temperature was input that exceeds the measurement temperature range set for the measurement range of each channel.	60 to 67
7)	When the A60MXT is used, "1" is displayed when broken wire is detected in the thermocouple or the compensating lead wire.	40 to 47
8)	When the A60MXT is used, the set status of the broken wire detection for the thermocouple that is connected to each channel is displayed. 0: Broken wire detection disabled 1: Broken wire detection enabled	20 to 27
9)	When the A60MXT is used, the temperature detection value of each channel is displayed.	200 to 27F
10)	The set temperature value (when the digital value is 0 or 4000) of the channel to which the A60MXT being monitored is connected is displayed.	30 to 3F
11)	A "■" is displayed when an error occurs.	—



## 12. OPERATION OF EACH SPECIAL MODULE MONITOR SCREEN

MELSEC GOT

### 12.18.3 I/O monitor

A616TD Input/Output Monitor Screen

Inputs (X)				Outputs (Y)			
00	WDT Error	10		00		10	LED Display
01	READY	11		01		11	
02	Error	12		02		12	
03	Discon. Error	13		03		13	
04	Digital Error	14		04		14	
05	Temp. Error	15		05		15	
06		16		06		16	
07		17		07		17	
08		18		08		18	
09		19		09		19	
0A		1A		0A		1A	
0B		1B		0B		1B	
0C		1C		0C		1C	
0D		1D		0D		1D	
0E		1E		0E		1E	
0F		1F		0F		1F	

1) —

No.	Contents of display
1)	The ON/OFF status of the I/O signal corresponding to the PLC CPU is displayed. The I/O signal is ON when displayed in a reverse display.

## 12. OPERATION OF EACH SPECIAL MODULE MONITOR SCREEN

MELSEC GOT

### 12.18.4 Setting monitor (when A60MXT is used)

A616TD Setting Monitor Screen									SET/ RESET	Data Chg.	MONIT MENU	END
	CNT No.0	CNT No.1	CNT No.2	CNT No.3	CNT No.4	CNT No.5	CNT No.6	CNT No.7				
CH 1	01234	0	01234	0	01234	0	01234	0	01234	0	01234	0
CH 2	01234	0	01234	0	01234	0	01234	0	01234	0	01234	0
CH 3	01234	0	01234	0	01234	0	01234	0	01234	0	01234	0
CH 4	01234	0	01234	0	01234	0	01234	0	01234	0	01234	0
CH 5	01234	0	01234	0	01234	0	01234	0	01234	0	01234	0
CH 6	01234	0	01234	0	01234	0	01234	0	01234	0	01234	0
CH 7	01234	0	01234	0	01234	0	01234	0	01234	0	01234	0
CH 8	01234	0	01234	0	01234	0	01234	0	01234	0	01234	0
CH 9	01234	0	01234	0	01234	0	01234	0	01234	0	01234	0
CH A	01234	0	01234	0	01234	0	01234	0	01234	0	01234	0
CH B	01234	0	01234	0	01234	0	01234	0	01234	0	01234	0
CH C	01234	0	01234	0	01234	0	01234	0	01234	0	01234	0
CH D	01234	0	01234	0	01234	0	01234	0	01234	0	01234	0
CH E	01234	0	01234	0	01234	0	01234	0	01234	0	01234	0
CH F	01234	0	01234	0	01234	0	01234	0	01234	0	01234	0
Col. A:	Err. Comp. Value	Error Code		If Error Code 70								
Col. B:	Sensor Type	[ 01 ]		Wrong Sensor Type				CNT No. 0 MX CH 0				

1)      2)                      3)                                      4)

No.	Contents of display	Buffer memory address to reference (hexadecimal)																																																																	
1)	<p>The set value corresponding to the thermocouple used in each channel is displayed only in the column of the the CNT No. to which the A60MXT is connected.</p> <p>The types of thermocouples that correspond to the set values are indicated below.</p> <table border="1" style="margin-left: 20px;"> <thead> <tr> <th rowspan="2">Set value Rating</th> <th colspan="10">Type of thermocouple</th> </tr> <tr> <th>0</th> <th>1</th> <th>2</th> <th>3</th> <th>4</th> <th>5</th> <th>6</th> <th>7</th> <th>8</th> <th></th> </tr> </thead> <tbody> <tr> <td>JIS</td> <td>K</td> <td>J</td> <td>E</td> <td>R</td> <td>T</td> <td>B</td> <td>S</td> <td>—</td> <td>—</td> <td></td> </tr> <tr> <td>ANSI</td> <td>K</td> <td>J</td> <td>E</td> <td>R</td> <td>T</td> <td>B</td> <td>S</td> <td>—</td> <td>—</td> <td></td> </tr> <tr> <td>BS</td> <td>NiCr -NiAl</td> <td>Fe -CuNi</td> <td>NiCr -CuNi</td> <td>PtRh13 -Pt</td> <td>Cu -CuNi</td> <td>PtRh30 -PtRh6</td> <td>PtRh10 -Pt</td> <td>—</td> <td>—</td> <td></td> </tr> <tr> <td>DIN</td> <td>NiCr -Ni</td> <td>—</td> <td>—</td> <td>—</td> <td>—</td> <td>—</td> <td>PtRh -Pt</td> <td>Fe -CuNi</td> <td>Cu -CuNi</td> <td></td> </tr> </tbody> </table>	Set value Rating	Type of thermocouple										0	1	2	3	4	5	6	7	8		JIS	K	J	E	R	T	B	S	—	—		ANSI	K	J	E	R	T	B	S	—	—		BS	NiCr -NiAl	Fe -CuNi	NiCr -CuNi	PtRh13 -Pt	Cu -CuNi	PtRh30 -PtRh6	PtRh10 -Pt	—	—		DIN	NiCr -Ni	—	—	—	—	—	PtRh -Pt	Fe -CuNi	Cu -CuNi		100 to 17F
Set value Rating	Type of thermocouple																																																																		
	0	1	2	3	4	5	6	7	8																																																										
JIS	K	J	E	R	T	B	S	—	—																																																										
ANSI	K	J	E	R	T	B	S	—	—																																																										
BS	NiCr -NiAl	Fe -CuNi	NiCr -CuNi	PtRh13 -Pt	Cu -CuNi	PtRh30 -PtRh6	PtRh10 -Pt	—	—																																																										
DIN	NiCr -Ni	—	—	—	—	—	PtRh -Pt	Fe -CuNi	Cu -CuNi																																																										
2)	The error correction value of each channel is displayed only in the column of the CNT No. to which the A60MXT is connected.	80 to FF																																																																	
3)	The error code is displayed when an error occurs.	1																																																																	
4)	The connect number and channel are displayed when an error occurs in the thermocouple type setting.	3																																																																	

12.18.5 Temperature monitor (connect No. 0 to connect No. 7 when A60MXT is used)

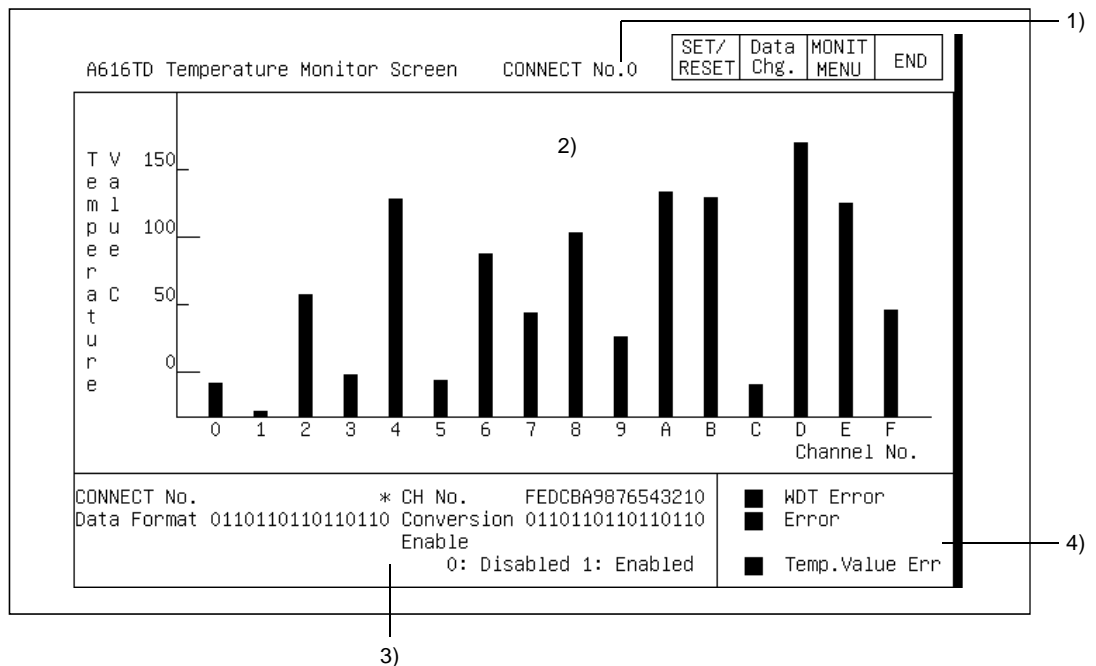

No.	Contents of display	Buffer memory address to reference (hexadecimal)
1)	The connect number of the monitor being used is displayed.	—
2)	The temperature detection value for each channel is graphically displayed.	200 to 27F
3)	The set status of the data format for each channel is displayed.	0
	The specified conversion enabled/disabled status for each channel is displayed.	10 to 17
4)	A "■" is displayed when a watchdog timer error occurs.	—
	A "▧" is displayed when an error occurs.	—
	A "▨" is displayed when a temperature was input that exceeds the measurement temperature range set for the measurement range of each channel.	—

## 12. OPERATION OF EACH SPECIAL MODULE MONITOR SCREEN

MELSEC GOT

### 12.18.6 Graph monitor (INPUT 0-F)

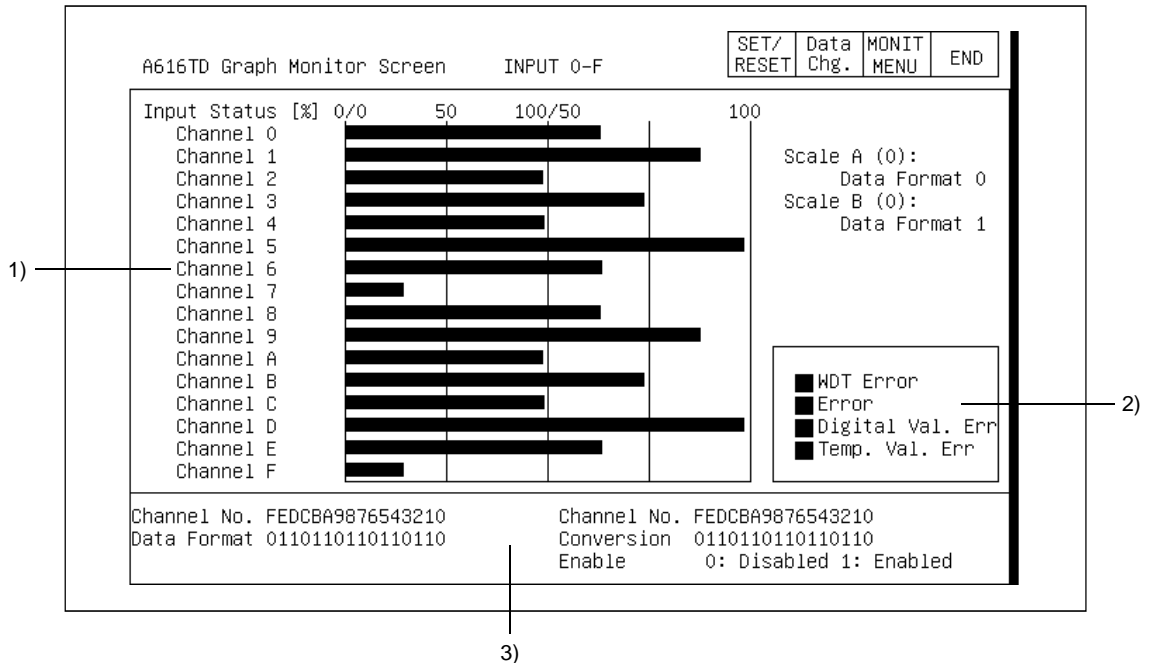

No.	Contents of display	Buffer memory address to reference (hexadecimal)
1)	For a channel not connected to the A60MX <sub>[ ]</sub> , the current output value, a value between 0 to 4000 for the digital output of that channel, is displayed as a percentage ranging from 0 to 100%. When a channel is connected to the A60MX <sub>[ ]</sub> , the above is displayed for the digital output value for CH0 of A60MX <sub>[ ]</sub> .	70 to 7F
2)	A "■" is displayed when a watchdog timer error occurs. A "■" is displayed when an error occurs. When the A60MXT is used, "■" is displayed when a temperature was input that exceeds the temperature range set according to the digital output value set for each channel. When the A60MXT is used, "■" is displayed when a temperature was input that exceeds the measurement temperature range set for the measurement range of each channel.	—
3)	The set status of the data format for each channel is displayed. The specified conversion enabled/disabled status for each channel is displayed.	0 F

## 12. OPERATION OF EACH SPECIAL MODULE MONITOR SCREEN

MELSEC GOT

### 12.18.7 Graph monitor (connect No. 0 to connect No. 7 when multiplex module is used)

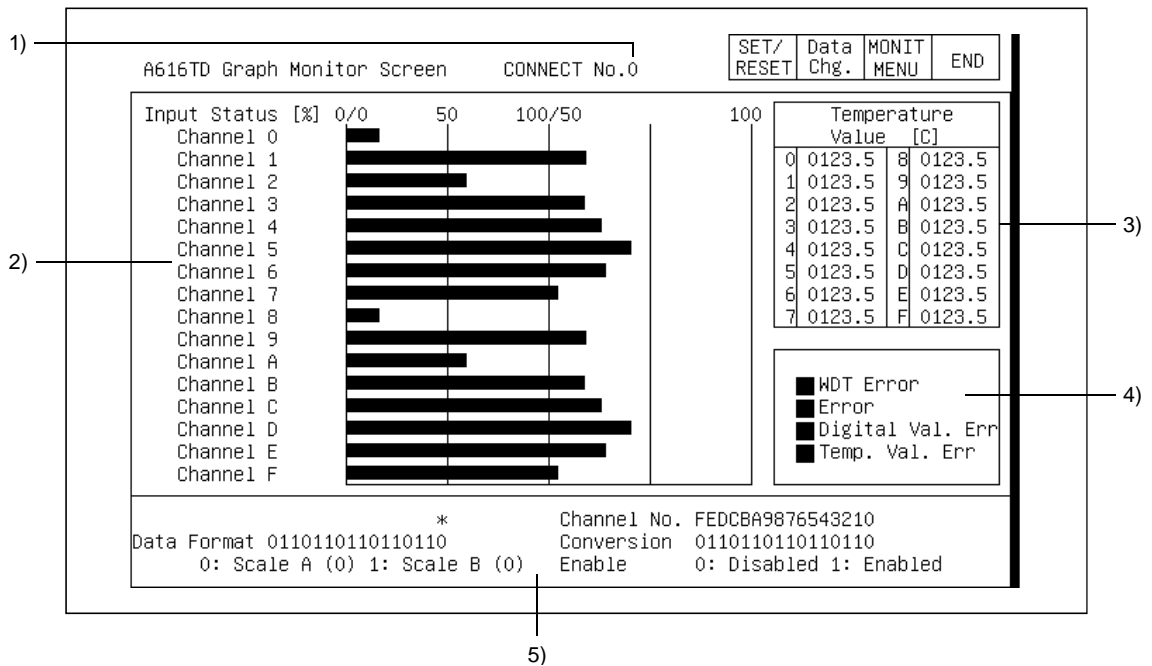

No.	Contents of display	Buffer memory address to reference (hexadecimal)
1)	The connect number of the monitor being used is displayed.	—
2)	The current output value, a value between 0 to 4000 for the digital output value of each channel, is displayed in a graph as a percentage ranging from 0 to 100%.	180 to 1FF
3)	When the A60MXT is used, the temperature detection value of each channel is displayed.	200 to 27F
4)	A "■" is displayed when a watchdog timer error occurs.	—
	A "■" is displayed when an error occurs.	—
	When the A60MXT is used, "1" is displayed when a temperature was input that exceeds the temperature range set according to the digital output value set for each channel.	—
5)	When the A60MXT is used, "1" is displayed when a temperature was input that exceeds the measurement temperature range set for the measurement range of each channel.	—
	The set status of the data format for each channel is displayed.	0
	The specified conversion enabled/disabled status for each channel is displayed.	10 to 17









12.19.3 I/O Monitor

SET/ RESET	Data Chg.	MONIT MENU	END
---------------	--------------	---------------	-----

AD70 Input/Output Monitor Screen

	Inputs (X)		Outputs (Y)
00	WDT Error 10	00	10 Zero Rtn Start
01	AD70 READY 11	01	11 Posit. Start
02	Zero Rtn Request 12	02	12 Forward Start
03	Zero Rtn Comple. 13	03	13 Reverse Start
04	BUSY 14	04	14 Fwd. Jog Start
05	Posit. Complete 15	05	15 Rev. Jog Start
06	In-position 16	06	16 Vel/Pos Restart
07	Excessive Error 17	07	17 Stop
08	Error Detection 18	08	18 Error Reset
09	Overflow 19	09	19 Overflow Reset
0A	Underflow 1A	0A	1A Underflow Reset
0B	Servo Ready 1B	0B	1B
0C	Near Zero Point 1C	0C	1C V/P Switchover
0D	Stop (External) 1D	0D	1D PLC READY
0E	Upper Limit LS 1E	0E	1E
0F	Lower Limit LS 1F	0F	1F

1) —

No.	Contents of display
1)	The ON/OFF status of the I/O signal corresponding to the PLC CPU is displayed. The I/O signal is ON when displayed in a reverse display.



12. OPERATION OF EACH SPECIAL MODULE MONITOR SCREEN

MELSEC GOT

No.	Contents of display	Buffer memory address to reference (decimal)																										
12)	The error code is displayed when an error occurs that can be handled by a sequence program such as a data error or BUSY in progress.	121																										
13)	The error code is displayed when an error occurs that causes monitoring to stop due to an external signal when starting or when a startup is in progress.	122																										
14)	The error code output from the servo amp that was converted into an error code for AD70D is displayed.	123																										
15)	The change value (PLS) of the current value is displayed.	80, 81																										
16)	The change value (PLS) of the speed/position/travel distance is displayed.	86, 87																										
17)	The change value of the velocity change is displayed.	82, 83																										
18)	The set value of the JOG velocity is displayed.	84, 85																										
19)	The change value of the torque limit is displayed.	89																										
20)	The actual number of revolutions of the motor is displayed.	110																										
21)	The motor current is displayed as 100% of the rated current.	111																										
22)	The data for monitoring the load of the regeneration resistance is displayed.	112																										
23)	The maximum torque is displayed when it is 100% of the rated torque.	113																										
24)	Valid when using peripheral equipment (SW [ ] ; GP-AD70DP).	125																										
	<table border="1"> <thead> <tr> <th>Bit</th> <th>8</th> <th>7</th> <th>6</th> <th>5</th> <th>4</th> <th>3</th> <th>2</th> <th>1</th> </tr> </thead> <tbody> <tr> <td rowspan="2">Contents of display</td> <td>0</td> <td>Servo Ready OFF</td> <td>—</td> <td>—</td> <td>—</td> <td>—</td> <td>—</td> <td>Test mode normal</td> <td>Not in test mode</td> </tr> <tr> <td>1</td> <td>Servo Ready ON</td> <td>—</td> <td>—</td> <td>—</td> <td>—</td> <td>—</td> <td>Test mode request error</td> <td>Test mode in progress</td> </tr> </tbody> </table>		Bit	8	7	6	5	4	3	2	1	Contents of display	0	Servo Ready OFF	—	—	—	—	—	Test mode normal	Not in test mode	1	Servo Ready ON	—	—	—	—	—
Bit	8	7	6	5	4	3	2	1																				
Contents of display	0	Servo Ready OFF	—	—	—	—	—	Test mode normal	Not in test mode																			
	1	Servo Ready ON	—	—	—	—	—	Test mode request error	Test mode in progress																			
25)	The set status of the AD70D slide switch is displayed.	126																										
	<table border="1"> <thead> <tr> <th>Bit</th> <th>8</th> <th>7</th> <th>6</th> <th>5</th> <th>4</th> <th>3</th> <th>2</th> <th>1</th> </tr> </thead> <tbody> <tr> <td rowspan="2">Contents of display</td> <td>0</td> <td>SW8 "OFF"</td> <td>SW7 "OFF"</td> <td>SW6 "OFF"</td> <td>SW5 "OFF"</td> <td>SW4 "OFF"</td> <td>SW3 "OFF"</td> <td>SW2 "OFF"</td> <td>SW1 "OFF"</td> </tr> <tr> <td>1</td> <td>SW8 "ON"</td> <td>SW7 "ON"</td> <td>SW6 "ON"</td> <td>SW5 "ON"</td> <td>SW4 "ON"</td> <td>SW3 "ON"</td> <td>SW2 "ON"</td> <td>SW1 "ON"</td> </tr> </tbody> </table>		Bit	8	7	6	5	4	3	2	1	Contents of display	0	SW8 "OFF"	SW7 "OFF"	SW6 "OFF"	SW5 "OFF"	SW4 "OFF"	SW3 "OFF"	SW2 "OFF"	SW1 "OFF"	1	SW8 "ON"	SW7 "ON"	SW6 "ON"	SW5 "ON"	SW4 "ON"	SW3 "ON"
Bit	8	7	6	5	4	3	2	1																				
Contents of display	0	SW8 "OFF"	SW7 "OFF"	SW6 "OFF"	SW5 "OFF"	SW4 "OFF"	SW3 "OFF"	SW2 "OFF"	SW1 "OFF"																			
	1	SW8 "ON"	SW7 "ON"	SW6 "ON"	SW5 "ON"	SW4 "ON"	SW3 "ON"	SW2 "ON"	SW1 "ON"																			

## 12. OPERATION OF EACH SPECIAL MODULE MONITOR SCREEN

MELSEC GOT

### 12.20.2 Zero return monitor

AD70D Zero Return Data Monitor Screen				SET/ RESET	Data Chg.	MONIT MENU	END	
Y11	Posit. Start	Feed Position	2)01234567890	Present Value	01234567890			16)
Y12	Forward Start	Actual Position	3)01234567890	Travel Dist.	01234567890			17)
Y13	Reverse Start							
Y14	Fwd. Jog Start	Error Counter	4)01234567890	Velocity	012345 PLS/s			18)
Y15	Rev. Jog Start							
Y16	Vel/Pos Restart	Zero Address	5)01234567890	Jog Velocity	012345 PLS/s			19)
X05	Posit. Complete							
	Zero Rtn Request	Zero Rtn Vel.	6)012345 PLS/s	Torque Limit	012345 %			20)
Y10	Zero Rtn Start	Creep Velocity	7)012345 PLS/s	Motor Speed	012345 rpm			21)
X03	Zero Rtn Comple.	Zero Rtn Dist.	8)01234567890					
Y17	Stop	Near Zero Dist.	9)01234567890	Motor Current	012345 %			22)
X04	BUSY In-position							
		Near Zero Set.	10)01234567890	Regen. Level	012345 %			23)
Y1B	Servo OFF	V/P Mode	0 0: Pos 1: Vel	Max. Torque	012345 %			24)
Y1C	V/P Switchover	Torque Control Mode	0	Test Mode	0110110110110110 87654321			25)
X00	WDT Error	Err. Code	1:012 2:0123 S:0123	S/Switch	0110110110110110			26)
X08	Error Detection							

11) 12) 13) 14) 15)

No.	Contents of display	Buffer memory address to reference (decimal)
1)	The ON/OFF status of the I/O signal corresponding to the PLC CPU is displayed. The I/O signal is ON when displayed in a reverse display.	—
2)	The calculated command pulse number (PLS) based on the command value is displayed.	100, 101
3)	The actual amount of servo movement (feedback pulse number) (PLS) calculated from the feedback pulse is displayed.	102, 103
4)	The difference between the command pulse number x CMS/CDV and the feedback pulse number (PLS) is displayed.	104, 105
5)	The set value (PLS) of the zero address is displayed.	30, 31
6)	The set value of the zero return velocity is displayed.	32, 33
7)	The set value of the creep velocity is displayed.	34, 35
8)	After zero return starts, the near zero point signal goes off, decelerates and stops. The travel distance (PLS) from that point until zero return is complete is displayed.	108, 109
9)	After zero return starts, the travel distance (PLS) from when the near zero point signal goes on until zero return is complete is displayed.	106, 107
10)	The set value (PLS) of the travel distance after the near zero point signal goes ON is displayed.	36, 37
11)	The status of the control mode when changing modes from velocity to position control is displayed. 0: Positioning control in progress      1: Velocity control in progress	119

## 12. OPERATION OF EACH SPECIAL MODULE MONITOR SCREEN

MELSEC GOT

No.	Contents of display	Buffer memory address to reference (decimal)																										
12)	This displays whether the torque command (electrical current command) for the motor is controlled by the rated torque written in the motor catalog x the "torque limit value". 0: When motor is rotating within set torque limit 1: Limited	120																										
13)	The error code is displayed when an error occurs that can be handled by a sequence program such as a data error or BUSY in progress.	121																										
14)	The error code is displayed when an error occurs that causes monitoring to stop due to an external signal when starting or when a startup is in progress.	122																										
15)	The error code output from the servo amp that was converted into an error code for AD70D is displayed.	123																										
16)	The change value (PLS) of the current value is displayed.	80, 81																										
17)	The change value (PLS) of the speed/position/travel distance is displayed.	86, 87																										
18)	The change value of the velocity change is displayed.	82, 83																										
19)	The set value of the JOG velocity is displayed.	84, 85																										
20)	The change value of the torque limit is displayed.	89																										
21)	The actual number of revolutions of the motor is displayed.	110																										
22)	The motor current is displayed as 100% of the rated current.	111																										
23)	The data for monitoring the load of the regeneration resistance is displayed.	112																										
24)	The maximum torque is displayed when it is 100% of the rated torque.	113																										
25)	Valid when using peripheral equipment (SW [ ] GP-AD70DP).	125																										
	<table border="1"> <thead> <tr> <th>Bit</th> <th>8</th> <th>7</th> <th>6</th> <th>5</th> <th>4</th> <th>3</th> <th>2</th> <th>1</th> </tr> </thead> <tbody> <tr> <td rowspan="2">Contents of display</td> <td>0</td> <td>Servo ready OFF</td> <td>—</td> <td>—</td> <td>—</td> <td>—</td> <td>—</td> <td>Test mode normal</td> <td>Not in test mode</td> </tr> <tr> <td>1</td> <td>Servo ready ON</td> <td>—</td> <td>—</td> <td>—</td> <td>—</td> <td>—</td> <td>Test mode request error</td> <td>Test mode in progress</td> </tr> </tbody> </table>		Bit	8	7	6	5	4	3	2	1	Contents of display	0	Servo ready OFF	—	—	—	—	—	Test mode normal	Not in test mode	1	Servo ready ON	—	—	—	—	—
Bit	8	7	6	5	4	3	2	1																				
Contents of display	0	Servo ready OFF	—	—	—	—	—	Test mode normal	Not in test mode																			
	1	Servo ready ON	—	—	—	—	—	Test mode request error	Test mode in progress																			
26)	The set status of the AD70D slide switch is displayed.	126																										
	<table border="1"> <thead> <tr> <th>Bit</th> <th>8</th> <th>7</th> <th>6</th> <th>5</th> <th>4</th> <th>3</th> <th>2</th> <th>1</th> </tr> </thead> <tbody> <tr> <td rowspan="2">Contents of display</td> <td>0</td> <td>SW8 "OFF"</td> <td>SW7 "OFF"</td> <td>SW6 "OFF"</td> <td>SW5 "OFF"</td> <td>SW4 "OFF"</td> <td>SW3 "OFF"</td> <td>SW2 "OFF"</td> <td>SW1 "OFF"</td> </tr> <tr> <td>1</td> <td>SW8 "ON"</td> <td>SW7 "ON"</td> <td>SW6 "ON"</td> <td>SW5 "ON"</td> <td>SW4 "ON"</td> <td>SW3 "ON"</td> <td>SW2 "ON"</td> <td>SW1 "ON"</td> </tr> </tbody> </table>		Bit	8	7	6	5	4	3	2	1	Contents of display	0	SW8 "OFF"	SW7 "OFF"	SW6 "OFF"	SW5 "OFF"	SW4 "OFF"	SW3 "OFF"	SW2 "OFF"	SW1 "OFF"	1	SW8 "ON"	SW7 "ON"	SW6 "ON"	SW5 "ON"	SW4 "ON"	SW3 "ON"
Bit	8	7	6	5	4	3	2	1																				
Contents of display	0	SW8 "OFF"	SW7 "OFF"	SW6 "OFF"	SW5 "OFF"	SW4 "OFF"	SW3 "OFF"	SW2 "OFF"	SW1 "OFF"																			
	1	SW8 "ON"	SW7 "ON"	SW6 "ON"	SW5 "ON"	SW4 "ON"	SW3 "ON"	SW2 "ON"	SW1 "ON"																			

12.20.3 Parameter data monitor

AD70D Parameter Data Monitor Screen			SET/ RESET	Data Chg.	MONIT MENU	END	
Y11	Posit. Start	Upper Limit 2)	01234567890	In-position Range	012345	PLS	13)
Y12	Forward Start						
Y13	Reverse Start	Lower Limit 3)	01234567890	Feedback Pulses	012345	PLS	14)
Y14	Fwd. Jog Start						
Y15	Rev. Jog Start	Electronic Gear 4)	0123/ 0123	Rotation Direction	0		15)
Y16	Vel/Pos Restart						
X05	Posit. Complete	System Setting 5)	0	Torque Limit	012345	%	16)
	Zero Rtn Request	Regen. Resistance 6)	0	Velocity Limit	0123456	PLS/s	17)
Y10	Zero Rtn Start						
X03	Zero Rtn Comple.	Motor Type 7)	0	Accel. Time	012345	ms	18)
	8)						
Y17	Stop	Motor Capacity	0123.5 kW	Decel. Time	012345	ms	19)
X04	BUSY						
	In-position	9)					
	10)	Motor Rotations	012345 rpm	Positioning Mode	0		20)
Y1B	Servo OFF	11)					
Y1C	V/P Switchover	Pos. Loop Gain	012345 rad/s	Amplifier Ver.	A01W012-ABC		21)
X00	WDT Error	12)					
X08	Error Detection	Vel. Loop Gain	012345	Test Mode	0110110110110110- 87654321		22)
		Vel. Integration	012345 ms	S/Switch	0110110110110110		23)

No.	Contents of display	Buffer memory address to reference (decimal)
1)	The ON/OFF status of the I/O signal corresponding to the PLC CPU is displayed. The I/O signal is on when displayed in a reverse display.	—
2)	The set value (PLS) of the upper stroke limit is displayed.	0, 1
3)	The set value (PLS) of the lower stroke limit is displayed.	2, 3
4)	The command pulse ratio numerator (CMX) and denominator (CDV) are displayed.	4, 5
5)	The set status of the system is displayed. 0: MR-SB (standard) 1: MR-SB (absolute values)	10
6)	The set status of the regeneration resistance is displayed. 0: None 1: RB30 2: RB50,51 3: RB100, 101	11
7)	The set status of the motor type is displayed. 0: Standard 1: Low inertia L 2: Flat U	12
8)	The motor output capacity is displayed.	13
9)	The set status of the motor rpm is displayed.	14
10)	The set value of the position loop gain is displayed.	15
11)	The set value of the velocity loop gain is displayed.	16
12)	The set value of the velocity integration is displayed.	17
13)	The set value of the in-position range is displayed.	18
14)	The feedback pulse number (PLS) of one revolution of the motor is displayed.	19
15)	The set status of the direction of rotation is displayed. 0: Counter-clockwise with address increase 1: Clockwise with address increase	20
16)	The set value of the torque limit is displayed.	21
17)	The set value of the velocity limit is displayed.	40, 41

## 12. OPERATION OF EACH SPECIAL MODULE MONITOR SCREEN

MELSEC GOT

No.	Contents of display	Buffer memory address to reference (decimal)																											
18)	The set value of the acceleration time is displayed.	42																											
19)	The set value of the deceleration time is displayed.	43																											
20)	The set status of the positioning mode is displayed. 0: Positioning mode    1: Velocity → position control change mode	44																											
21)	The servo amp model code and version are displayed.	114 to 117																											
22)	Valid when using peripheral instrument (SW[ ]GP-AD70DP)																												
	<table border="1"> <thead> <tr> <th>Bit</th> <th>8</th> <th>7</th> <th>6</th> <th>5</th> <th>4</th> <th>3</th> <th>2</th> <th>1</th> </tr> </thead> <tbody> <tr> <td rowspan="2">Contents of display</td> <td>0</td> <td>Servo ready OFF</td> <td>—</td> <td>—</td> <td>—</td> <td>—</td> <td>—</td> <td>Test mode normal</td> <td>Not in test mode</td> </tr> <tr> <td>1</td> <td>Servo ready ON</td> <td>—</td> <td>—</td> <td>—</td> <td>—</td> <td>—</td> <td>Test mode request error</td> <td>Test mode in progress</td> </tr> </tbody> </table>	Bit	8	7	6	5	4	3	2	1	Contents of display	0	Servo ready OFF	—	—	—	—	—	Test mode normal	Not in test mode	1	Servo ready ON	—	—	—	—	—	Test mode request error	Test mode in progress
Bit	8	7	6	5	4	3	2	1																					
Contents of display	0	Servo ready OFF	—	—	—	—	—	Test mode normal	Not in test mode																				
	1	Servo ready ON	—	—	—	—	—	Test mode request error	Test mode in progress																				
23)	The set status of the AD70D slide switch is displayed.																												
	<table border="1"> <thead> <tr> <th>Bit</th> <th>8</th> <th>7</th> <th>6</th> <th>5</th> <th>4</th> <th>3</th> <th>2</th> <th>1</th> </tr> </thead> <tbody> <tr> <td rowspan="2">Contents of display</td> <td>0</td> <td>SW8 "OFF"</td> <td>SW7 "OFF"</td> <td>SW6 "OFF"</td> <td>SW5 "OFF"</td> <td>SW4 "OFF"</td> <td>SW3 "OFF"</td> <td>SW2 "OFF"</td> <td>SW1 "OFF"</td> </tr> <tr> <td>1</td> <td>SW8 "ON"</td> <td>SW7 "ON"</td> <td>SW6 "ON"</td> <td>SW5 "ON"</td> <td>SW4 "ON"</td> <td>SW3 "ON"</td> <td>SW2 "ON"</td> <td>SW1 "ON"</td> </tr> </tbody> </table>	Bit	8	7	6	5	4	3	2	1	Contents of display	0	SW8 "OFF"	SW7 "OFF"	SW6 "OFF"	SW5 "OFF"	SW4 "OFF"	SW3 "OFF"	SW2 "OFF"	SW1 "OFF"	1	SW8 "ON"	SW7 "ON"	SW6 "ON"	SW5 "ON"	SW4 "ON"	SW3 "ON"	SW2 "ON"	SW1 "ON"
Bit	8	7	6	5	4	3	2	1																					
Contents of display	0	SW8 "OFF"	SW7 "OFF"	SW6 "OFF"	SW5 "OFF"	SW4 "OFF"	SW3 "OFF"	SW2 "OFF"	SW1 "OFF"																				
	1	SW8 "ON"	SW7 "ON"	SW6 "ON"	SW5 "ON"	SW4 "ON"	SW3 "ON"	SW2 "ON"	SW1 "ON"																				

## 12. OPERATION OF EACH SPECIAL MODULE MONITOR SCREEN

MELSEC GOT

### 12.20.4 I/O monitor

AD70D Input/Output Monitor Screen

Inputs (X)		Outputs (Y)	
00	WDT Error	10	Zero Rtn Start
01	READY	11	Posit. Start
02	Zero Rtn Request	12	Forward Start
03	Zero Rtn Comple.	13	Reverse Start
04	BUSY	14	Fwd. Jog Start
05	Posit. Complete	15	Rev. Jog Start
06	In-position	16	Vel/Pos Restart
07	Zero Return	17	Stop
08	Error Detection	18	Error Reset
09	Overflow	19	Overflow Reset
0A	Underflow	1A	Underflow Reset
0B	Servo Ready	1B	Servo OFF
0C	Near Zero Point	1C	V/P Switchover
0D	Stop (External)	1D	PLC READY
0E	Upper Limit LS	1E	
0F	Lower Limit LS	1F	

1) —

No.	Contents of display
1)	The ON/OFF status of the I/O signal corresponding to the PLC CPU is displayed. The I/O signal is ON when displayed in a reverse display.



## 12. OPERATION OF EACH SPECIAL MODULE MONITOR SCREEN

MELSEC GOT

### 12.21 AD71 Module monitor

#### 12.21.1 Positioning monitor

AD71 Positioning Data Monitor Screen				SET/ RESET	Data Chg.	MONIT MENU	END
X	Y			3) X Axis	4) Y Axis	X	Y
Y10 Y11	Posit. Start	Exec.Data No.	012 Pt 01	012 Pt 01	012 Pt 01	01	012
Y12	Interpolation					02	012
X02 X03	Posit. Compl.	Present Value	5) 0123456789	0123456789	0123456789	03	012
X06 X07	Zero Request	Change Value	6) 0123456789	0123456789	0123456789	04	012
Y13 Y14	Zero Start	Zero Address	7) 0123456789	0123456789	0123456789	05	012
X0C X0D	Zero Complete					06	012
Y17 Y19	Fwd.Jog Start	Output Speed	8) 01234567	01234567	01234567	07	012
Y18 Y1A	Rev.Jog Start	Speed Limit	9) 01234567	01234567	01234567	08	012
Y15 Y16	Stop	Speed Change	10) 01234567	01234567	01234567	09	012
X08 X09	Pos. Started	Jog Speed	11) 01234567	01234567	01234567	10	012
X04 X05	BUSY	Jog Spd.Limit	12) 01234567	01234567	01234567	11	012
X0E X0F	M Code ON					12	012
X00	WDT Err Man.Pulse	MCode/ErrCode	012	01	012	01	012
X0A	Batt.ErrX:Wi					13	012
X0B	Error Y:Wi					14	012
						15	012

No.	Contents of display	Buffer memory address to reference (decimal)	
		X axis	Y axis
1)	The ON/OFF status of the I/O signal corresponding to the PLC CPU is displayed. The I/O signal is ON when displayed in a reverse display.	—	—
2)	The set manual pulser run enabled/disabled status is displayed.	47	347
3)	The data number during execution of current positioning is displayed.	48	348
4)	The remaining pointer value is displayed.	39	339
5)	The current value during execution of current positioning is displayed.	602 603	604 605
6)	The change value of the current value is displayed.	41 42	341 342
7)	The zero address set value is displayed.	7912 7913	7922 7923
8)	The set value of the output speed is displayed.	600	601
9)	The set value of the speed limit is displayed.	7874	7894
10)	The change value of the speed change is displayed.	40	340
11)	The set value of the jog speed is displayed.	44	344
12)	The set value of the jog speed limit is displayed.	7875	7895
13)	The set value of the M code is displayed. 0: M code not used	46	346
14)	The error code is displayed when an error occurs.	45	345
15)	The starting data number of each point is displayed.	0 to 37	300 to 337

12.21.2 Zero return monitor

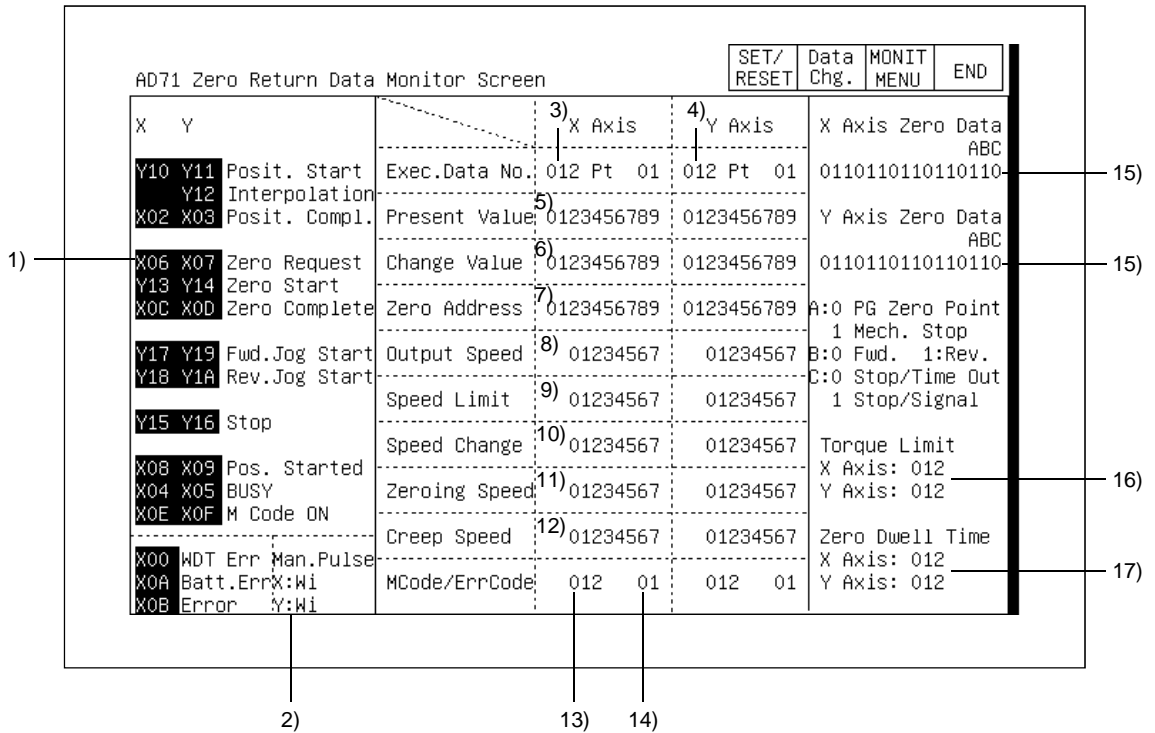

No.	Contents of display	Buffer memory address to reference (decimal)	
		X axis	Y axis
1)	The ON/OFF status of the I/O signal corresponding to the PLC CPU is displayed. The I/O signal is ON when displayed in a reverse display.	—	—
2)	The set manual pulser run enabled/disabled status is displayed.	47	347
3)	The data number during execution of current positioning is displayed.	48	348
4)	The remaining pointer value is displayed.	39	339
5)	The current value during execution of current positioning is displayed.	602 603	604 605
6)	The change value of the current value is displayed.	41 42	341 342
7)	The zero address set value is displayed.	7912 7913	7922 7923
8)	The set value of the output speed is displayed.	600	601
9)	The set value of the speed limit is displayed.	7874	7894
10)	The change value of the speed change is displayed.	40	340
11)	The set value of the zero return speed is displayed.	7914	7924
12)	The set value of the zero return creep speed is displayed.	7915	7925
13)	The set value of the M code is displayed. 0: M code not used	46	346
14)	The error code is displayed when an error occurs.	45	345
15)	The zero return data is displayed. 	7918	7928
16)	The set value of the torque limit is displayed.	7917	7927
17)	The set value of the dwell time is displayed.	7916	7926

12.21.3 Parameter data monitor

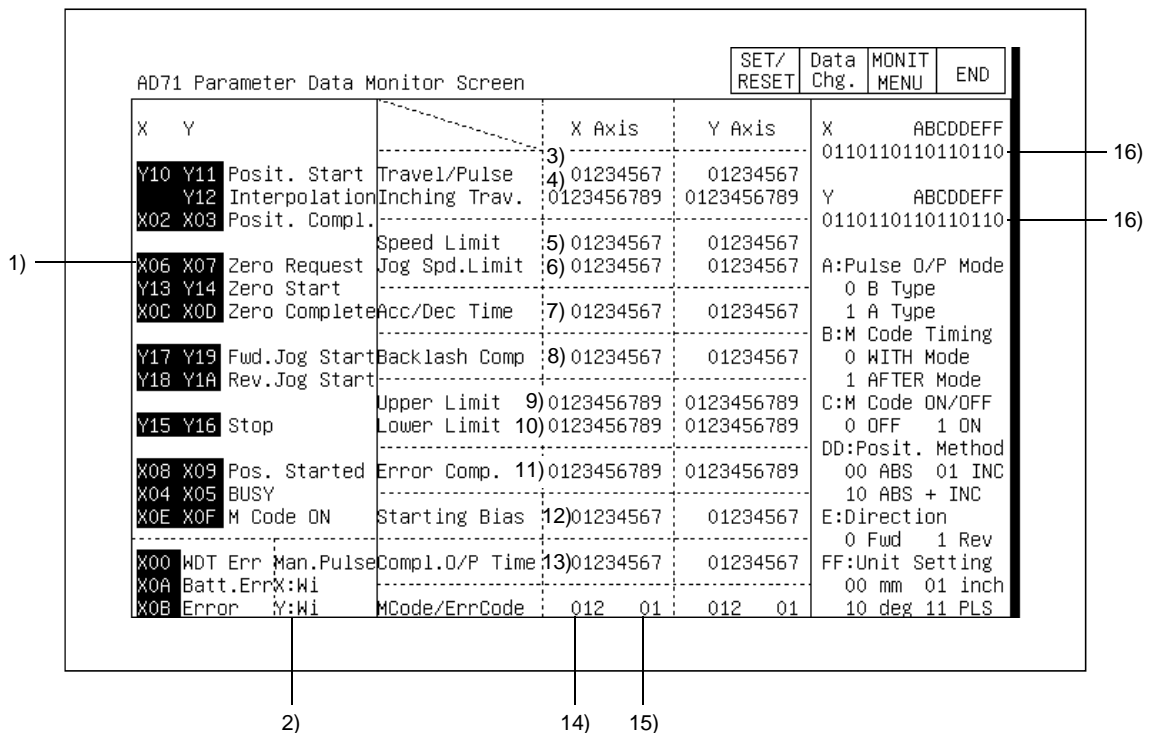

No.	Contents of display	Buffer memory address to reference (decimal)	
		X axis	Y axis
1)	The ON/OFF status of the I/O signal corresponding to the PLC CPU is displayed.The I/O signal is ON when displayed in a reverse display.	—	—
2)	The set manual pulser run enabled/disabled status is displayed.	47	347
3)	The set value of the travel distance per 1 pulse is displayed.	7873	7893
4)	The set value of the travel distance per 1 pulse using the manual pulser is displayed.	7884 7885	7904 7905
5)	The set value of the speed limit is displayed.	7874	7894
6)	The set value of the jog speed limit is displayed.	7875	7895
7)	The set value of the acceleration/deceleration time is displayed.	7876	7896
8)	The set value of the backlash compensation amount is displayed.	7877	7897
9)	The set value of the upper stroke limit is displayed.	7878 7879	7898 7899
10)	The set value of the lower stroke limit is displayed.	7880 7881	7900 7901
11)	The set value of the error compensation amount is displayed.	7882 7883	7902 7903
12)	The set value of the starting bias speed is displayed.	7886	7906
13)	The set value of the positioning complete signal output time is displayed.	7887	7907
14)	The set value of the M code is displayed.	46	346
15)	The error code is displayed when an error occurs.	45	345
16)	The set status of the parameter data is displayed.	7872	7892

12.21.4 M code comment monitor

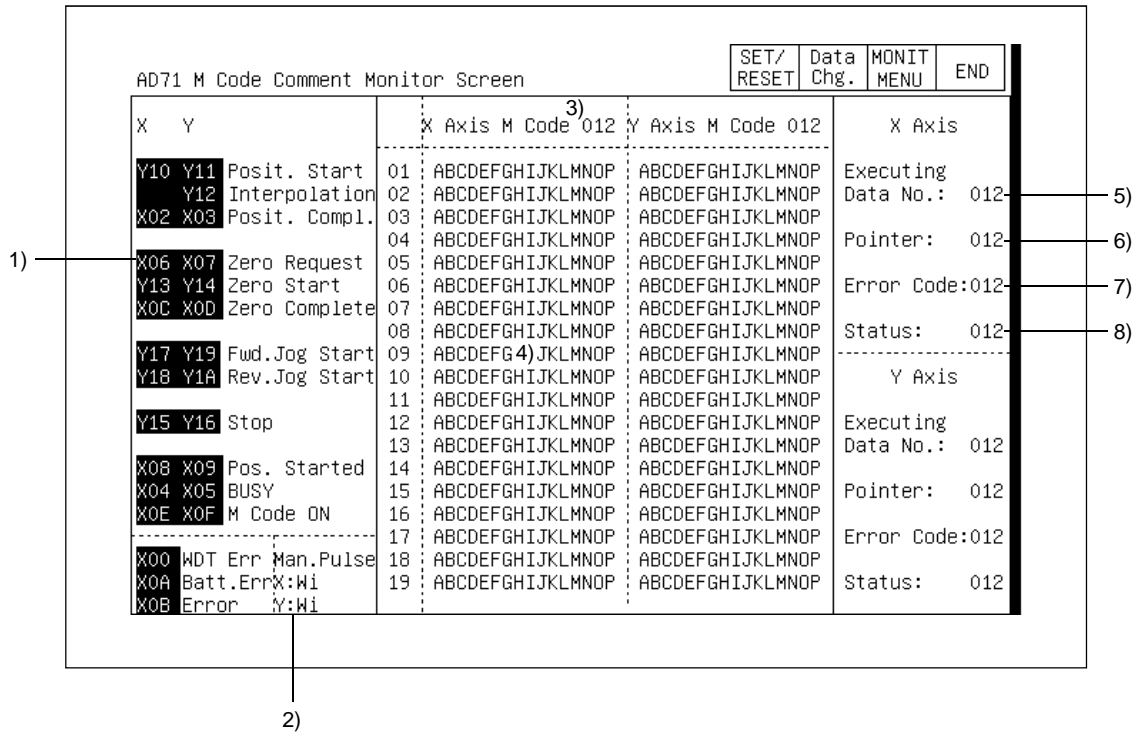

No.	Contents of display	Buffer memory address to reference (decimal)	
		X axis	Y axis
1)	The ON/OFF status of the I/O signal corresponding to the PLC CPU is displayed. The I/O signal is ON when displayed in a reverse display.	—	—
2)	The set manual pulser run enabled/disabled status is displayed.	47	347
3)	The set value of the M code is displayed.	46	346
4)	The set value of the comment for the M code is displayed.	49 to 200	349 to 500
5)	The data number during execution of current positioning is displayed.	48	348
6)	The remaining pointer value is displayed.	39	339
7)	The error code is displayed when an error occurs.	45	345
8)	<p>The 8 bits where the status is saved are displayed in hexadecimal format. When "FF" is displayed</p>	43	343

12.21.5 I/O monitor

AD71 Input/Output Monitor Screen				SET/ RESET	Data Chg.	MONIT MENU	END
Inputs (X)				Outputs (Y)			
00	WDT Error	10		00		10	X Posit. Start
01	READY	11		01		11	Y Posit. Start
02	X Posit. Complete	12		02		12	Interpolation
03	Y Posit. Complete	13		03		13	X Zeroing Start
04	X Axis BUSY	14		04		14	Y Zeroing Start
05	Y Axis BUSY	15		05		15	X Stop
06	X Zero Request	16		06		16	Y Stop
07	Y Zero Request	17		07		17	X Fwd. Jog Start
08	X Posit. Started	18		08		18	X Rev. Jog Start
09	Y Posit. Started	19		09		19	Y Fwd. Jog Start
0A	Battery Error	1A		0A		1A	Y Rev. Jog Start
0B	Error Detection	1B		0B		1B	X M Code OFF
0C	X Zero Complete	1C		0C		1C	Y M Code OFF
0D	Y Zero Complete	1D		0D		1D	PLC READY
0E	X M Code ON	1E		0E		1E	
0F	Y M Code ON	1F		0F		1F	

1)

No.	Contents of display
1)	The ON/OFF status of the I/O signal corresponding to the PLC CPU is displayed. The I/O signal is ON when displayed in a reverse display.

12.21.6 Positioning data monitor

The positioning Data Monitor Screen No. 1 is used as an example.

AD71 Positioning Data Monitor Screen										SET/ RESET	Data Chg.	MONIT MENU	END		
001	01234567	01234	012	012	0	001	01234567	01234	012	012	0				
002	01234567	01234	012	012	0	002	01234567	01234	012	012	0				
003	01234567	01234	012	012	0	003	01234567	01234	012	012	0				
004	01234567	01234	012	012	0	004	01234567	01234	012	012	0				
005	01234567	01234	012	012	0	005	01234567	01234	012	012	0				
006	01234567	01234	012	012	0	006	01234567	01234	012	012	0				
007	01234567	01234	012	012	0	007	01234567	01234	012	012	0				
008	01234567	01234	012	012	0	008	01234567	01234	012	012	0				
009	01234567	01234	012	012	0	009	01234567	01234	012	012	0				
010	01234567	01234	012	012	0	010	01234567	01234	012	012	0				
011	01234567	01234	012	012	0	011	01234567	01234	012	012	0				
012	01234567	01234	012	012	0	012	01234567	01234	012	012	0				
013	01234567	01234	012	012	0	013	01234567	01234	012	012	0				
014	01234567	01234	012	012	0	014	01234567	01234	012	012	0				
015	01234567	01234	012	012	0	015	01234567	01234	012	012	0				
016	01234567	01234	012	012	0	016	01234567	01234	012	012	0				
017	01234567	01234	012	012	0	017	01234567	01234	012	012	0				
018	01234567	01234	012	012	0	018	01234567	01234	012	012	0				
019	01234567	01234	012	012	0	019	01234567	01234	012	012	0				
020	01234567	01234	012	012	0	020	01234567	01234	012	012	0				

1)                      2)                      3)                      4)                      5)

No.	Contents of display	Buffer memory address to reference (decimal)	
		X axis	Y axis
1)	The set value of the positioning address for each data number is displayed.	5072 to 5111	7072 to 7111
2)	The set value of the positioning speed for each data number is displayed.	4272 to 4291	6272 to 6291
3)	The set value of the dwell time for each data number is displayed.	4672 to 4691	6672 to 6691
4)	The set value of the M code for each data number is displayed.	3872 to 3891	5872 to 5891
5)	<p>The 4 bits where the set status of the positioning pattern, the positioning method, and the positioning direction for each data number is stored are displayed in hexadecimal format.</p> <p>When "F" is displayed</p> <p>1) Positioning pattern                      00: Positioning complete                      01: Positioning continues                      11: Speed changes and positioning continues</p> <p>2) Positioning method                      0: Absolute                      1: Incremental</p> <p>3) Positioning direction (only valid in incremental mode)                      0: Forward direction (address increase direction)                      1: Reverse direction (address decrease direction)</p>	3872 to 3891	5872 to 5891

12.22 AD72, A1SD71 module monitor

The contents displayed on each monitor of the AD72 module and the A1SD71 module are nearly identical, except for the sections displaying the module format.

The AD72 module monitor screen is used as an example in each of the following sections.

12.22.1 Positioning monitor

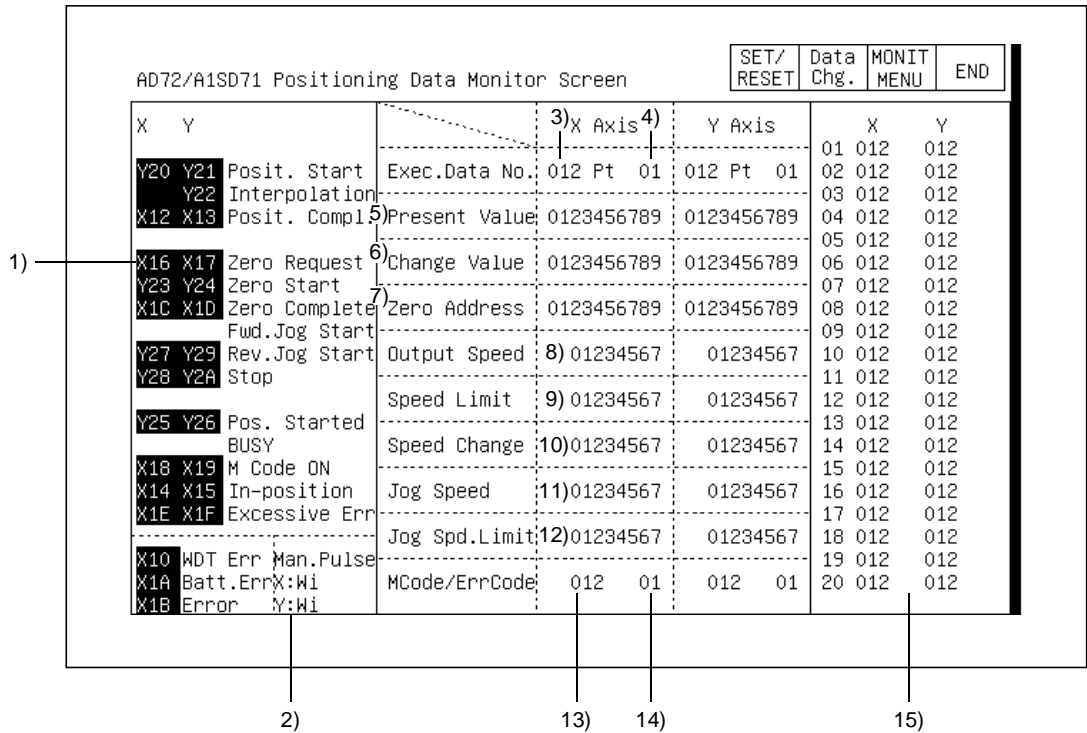

No.	Contents of display	Buffer memory address to reference (decimal)	
		X axis	Y axis
1)	The ON/OFF status of the I/O signal corresponding to the PLC CPU is displayed. The I/O signal is ON when displayed in a reverse display.	—	—
2)	The set manual pulser run enabled/disabled status is displayed.	47	347
3)	The data number during execution of current positioning is displayed.	48	348
4)	The remaining pointer value is displayed.	39	339
5)	The current value during execution of current positioning is displayed.	602	604
		603	605
6)	The change value of the current value is displayed.	41	341
		42	342
7)	The zero address set value is displayed.	7912	7922
		7913	7923
8)	The set value of the output speed is displayed.	600	601
9)	The set value of the speed limit is displayed.	7874	7894
10)	The change value of the speed change is displayed.	40	340
11)	The set value of the jog speed is displayed.	44	344
12)	The set value of the jog speed limit is displayed.	7875	7895
13)	The set value of the M code is displayed. 0: M code not used	46	346
14)	The error code is displayed when an error occurs.	45	345
15)	The starting data number of each point is displayed.	0 to 37	300 to 337

12.22.2 Zero return monitor

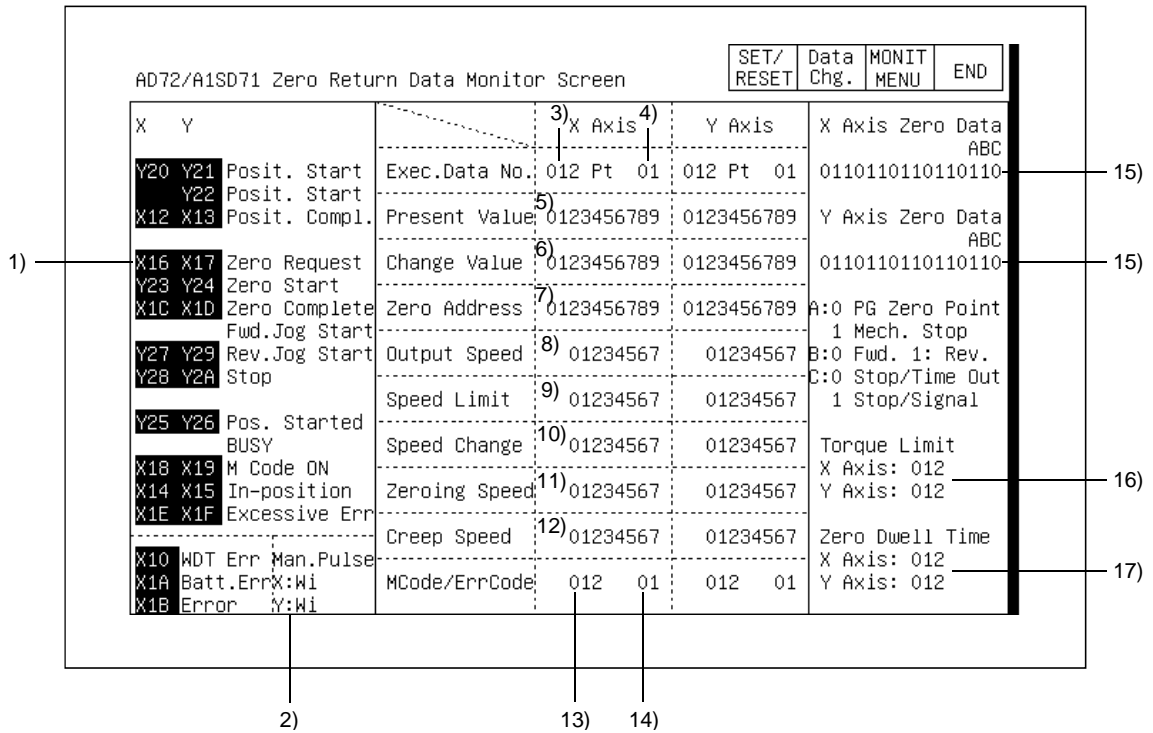

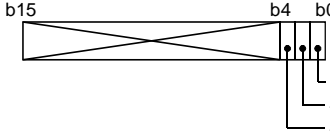
No.	Contents of display	Buffer memory address to reference (decimal)	
		X axis	Y axis
1)	The ON/OFF status of the I/O signal corresponding to the PLC CPU is displayed. The I/O signal is ON when displayed in a reverse display.	—	—
2)	The set manual pulser run enabled/disabled status is displayed.	47	347
3)	The data number during execution of current positioning is displayed.	48	348
4)	The remaining pointer value is displayed.	39	339
5)	The current value during execution of current positioning is displayed.	602 603	604 605
6)	The change value of the current value is displayed.	41 42	341 342
7)	The zero address set value is displayed.	7912 7913	7922 7923
8)	The set value of the output speed is displayed.	600	601
9)	The set value of the speed limit is displayed.	7874	7894
10)	The change value of the speed change is displayed.	40	340
11)	The set value of the zero return speed is displayed.	7914	7924
12)	The set value of the zero return creep speed is displayed.	7915	7925
13)	The set value of the M code is displayed. 0: M code not used	46	346
14)	The error code is displayed when an error occurs.	45	345
15)	The zero return data is displayed. Method where return is complete when stopper stops 	7918	7928
16)	The set value of the torque limit is displayed.	7917	7927
17)	The set value of the dwell time is displayed.	7916	7926



12.22.3 Parameter data monitor

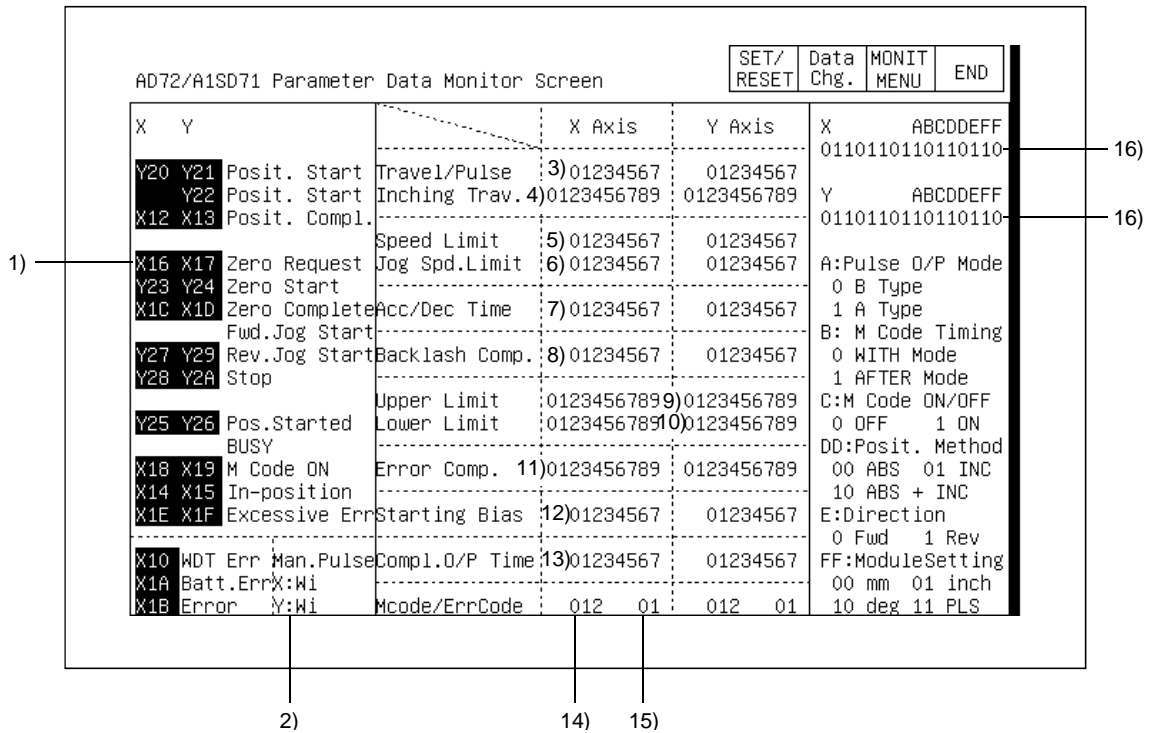

No.	Contents of display	Buffer memory address to reference (decimal)	
		X axis	Y axis
1)	The ON/OFF status of the I/O signal corresponding to the PLC CPU is displayed. The I/O signal is ON when displayed in a reverse display.	—	—
2)	The set manual pulser run enabled/disabled status is displayed.	47	347
3)	The set value of the travel distance per 1 pulse is displayed.	7873	7893
4)	The set value of the travel distance per 1 pulse using the manual pulser is displayed.	7884 7885	7904 7905
5)	The set value of the speed limit is displayed.	7874	7894
6)	The set value of the jog speed limit is displayed.	7875	7895
7)	The set value of the acceleration/deceleration time is displayed.	7876	7896
8)	The set value of the backlash compensation amount is displayed.	7877	7897
9)	The set value of the upper stroke limit is displayed.	7878 7879	7898 7899
10)	The set value of the lower stroke limit is displayed.	7880 7881	7900 7901
11)	The set value of the error compensation amount is displayed.	7882 7883	7902 7903
12)	The set value of the starting bias speed is displayed.	7886	7906
13)	The set value of the positioning complete signal output time is displayed.	7887	7907
14)	The set value of the M code is displayed. 0: M code not used	46	346
15)	The error code is displayed when an error occurs.	45	345
16)	The set status of the parameter data is displayed.	7872	7892

12.22.4 M code comment monitor

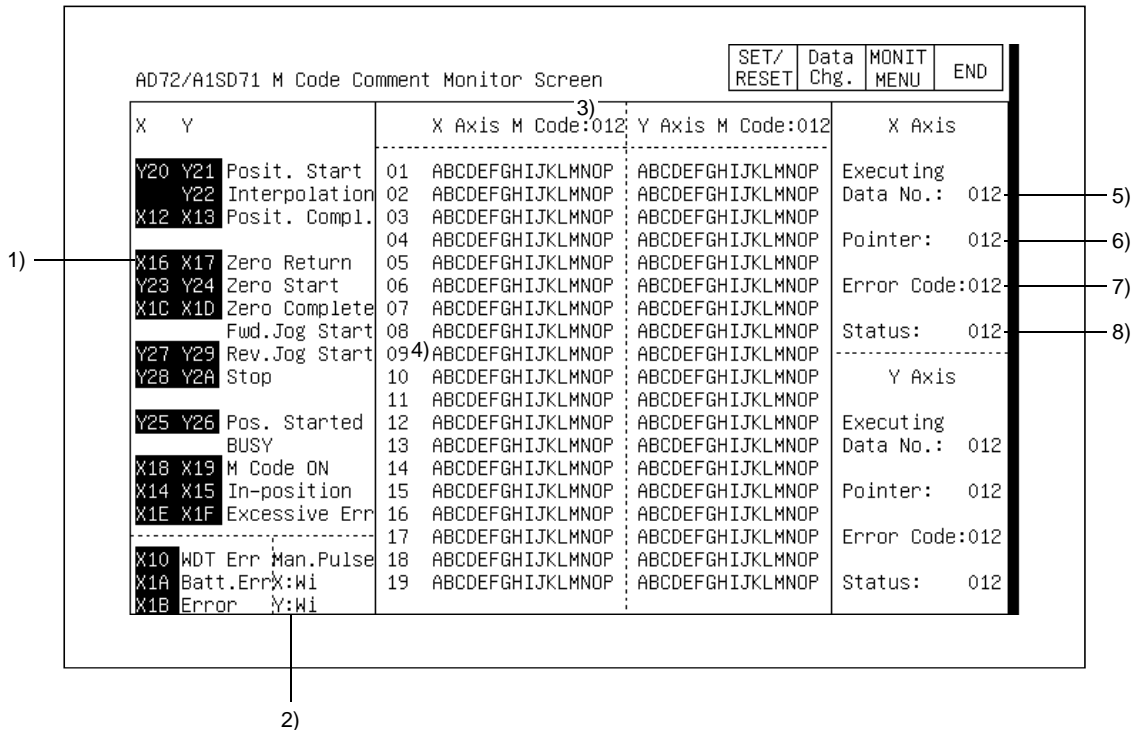

No.	Contents of display	Buffer memory address to reference (decimal)	
		X axis	Y axis
1)	The ON/OFF status of the I/O signal corresponding to the PLC CPU is displayed. The I/O signal is ON when displayed in a reverse display.	—	—
2)	The set manual pulser run enabled/disabled status is displayed.	47	347
3)	The set value of the M code is displayed.	46	346
4)	The set value of the comment for the M code is displayed.	49 to 200	349 to 500
5)	The data number during execution of current positioning is displayed.	48	348
6)	The remaining pointer value is displayed.	39	339
7)	The error code is displayed when an error occurs.	45	345
8)	<p>The 8 bits where the status is saved are displayed in hexadecimal format. When "FF" is displayed</p>	43	343

12.22.5 I/O monitor

AD72/A1SD71 Input/Output Monitor Screen

		SET/ RESET	Data Chg.	MONIT MENU	END		
Inputs (X)			Outputs (Y)				
00	10	WDT Error	20	X In-position	00	10	X Posit. Start
01	11	READY	21	Y In-position	01	11	Y Posit. Start
02	12	X Pos. Complete	22	X Excessive Err	02	12	Interpolation
03	13	Y Pos. Complete	23	Y Excessive Err	03	13	X Zero Start
04	14	X Axis BUSY	24		04	14	Y Zero Start
05	15	Y Axis BUSY	25		05	15	X Stop
06	16	X Zero Request	26		06	16	Y Stop
07	17	Y Zero Request	27		07	17	X Fwd.Jog Start
08	18	X Posit.Started	28		08	18	X Rev.Jog Start
09	19	Y Posit.Started	29		09	19	Y Fwd.Jog Start
0A	1A	Battery Error	2A		0A	1A	Y Rev.Jog Start
0B	1B	Error Detection	2B		0B	1B	X M Code OFF
0C	1C	X Zero Complete	2C		0C	1C	Y M Code OFF
0D	1D	Y Zero Complete	2D		0D	1D	PLC READY
0E	1E	X M Code ON	2E		0E	1E	2E
0F	1F	Y M Code ON	2F		0F	1F	2F

1) ———

No.	Contents of display
1)	The ON/OFF status of the I/O signal corresponding to the PLC CPU is displayed. The I/O signal is ON when displayed in a reverse display.

12.22.6 Positioning data monitor

The Positioning Data Monitor Screen No. 1 is used as an example.

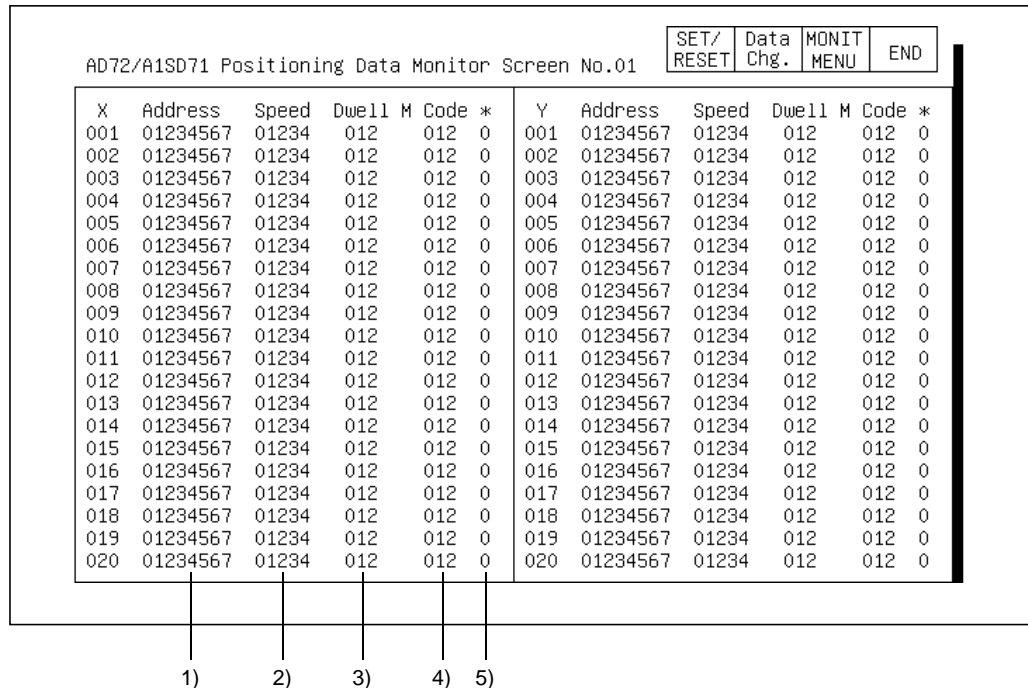

No.	Contents of display	Buffer memory address to reference (decimal)	
		X axis	Y axis
1)	The set value of the positioning address for each data number is displayed.	5072 to 5111	7072 to 7111
2)	The set value of positioning speed for each data number is displayed.	4272 to 4291	6272 to 6291
3)	The set value of the dwell time for each data number is displayed.	4672 to 4691	6672 to 6691
4)	The set value of the M code for each data number is displayed.	3872 to 3891	5872 to 5891
5)	<p>The 4 bits where the set status of the positioning pattern, the positioning method, and the positioning direction for each data number is stored are displayed in hexadecimal format.</p> <p>When "F" is displayed</p> <p>1) Positioning pattern                      00: Positioning complete                      01: Positioning continues                      11: Speed changes and positioning continues</p> <p>2) Positioning method                      0: Absolute                      1: Incremental</p> <p>3) Positioning direction (only valid in incremental mode)                      0: Forward direction (address increase direction)                      1: Reverse direction (address decrease direction)</p>	3872 to 3891	5872 to 5891

12.23 AD75, A1SD75 module monitor

The contents displayed on each monitor of the AD75P1 (P2, P3) module and the A1SD75P1 (P2, P3) module are nearly identical, except for the sections displaying the module format.

The AD75P3 module monitor screen is used as an example in this section.

12.23.1 I/O monitor

AD75P
I/O Monitor Screen

SET/ RESET	Data Chg.	MONIT MENU	END
---------------	--------------	---------------	-----

  

	X		Y	
00 AD75 Ready	10	00	10	Axis#1 Start
01 Axis#1 Started	11	01	11	Axis#2 "
02 Axis#2 "	12	02	12	Axis#3 "
03 Axis#3 "	13	03	13	Axis#1 Stop
04 Axis#1 BUSY	14	04	14	Axis#2 "
05 Axis#2 "	15	05	15	Spar
06 Axis#3 "	16	06	16	Axis#1 FWD JOG
07 Axis#1 Completed	17	07	17	Axis#1 RVS "
08 Axis#2 "	18	08	18	Axis#2 FWD "
09 Axis#3 "	19	09	19	Axis#2 RVS "
0A Axis#1 Error	1A	0A	1A	Axis#3 FWD "
0B Axis#2 "	1B	0B	1B	Axis#3 RVS "
0C Axis#3 "	1C	0C	1C	Axis#3 Stop
0D Axis#1 M Code	1D	0D	1D	Ready
0E Axis#2 "	1E	0E	1E	Not for use
0F Axis#3 "	1F	0F	1F	Not for use

1) ———

No.	Contents of display
1)	The ON/OFF status of the I/O signal corresponding to the PLC CPU is displayed. The I/O signal is ON when displayed in a reverse display.

12.23.2 Operation monitor

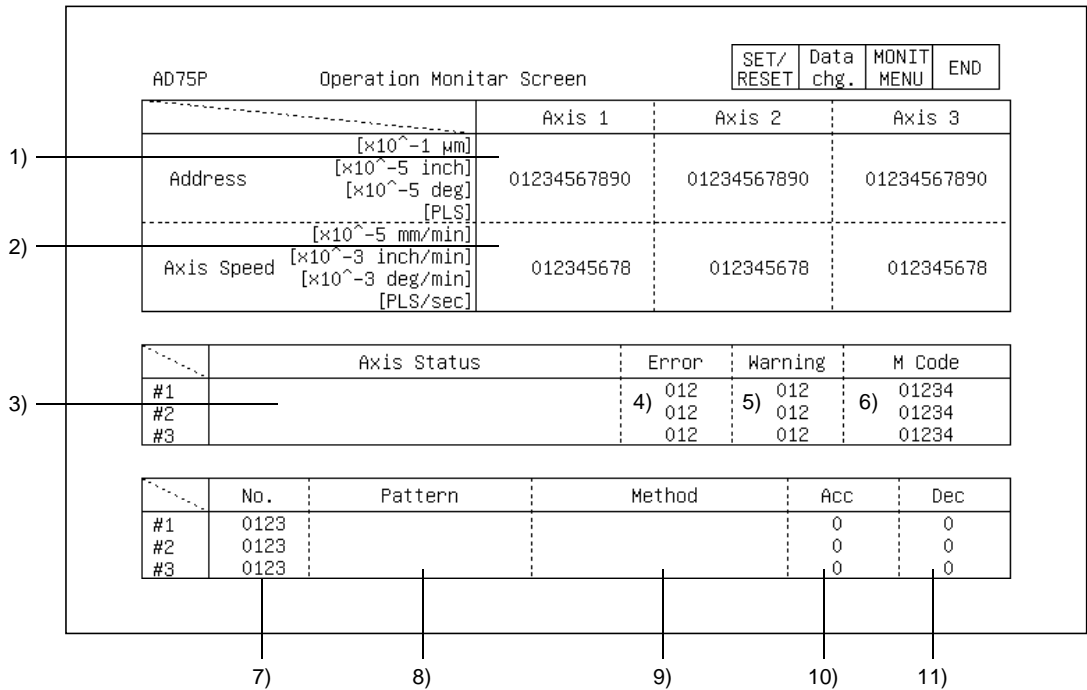

No.	Contents of display	Buffer memory address to reference (decimal)		
		Axis 1	Axis 2	Axis 3
1)	The feed current value is displayed.	800 801	900 901	1000 1001
2)	The axis speed is displayed.	812 813	912 913	1012 1013
3)	The axis operation status is displayed.	809	909	1009
4)	The axis error No. is displayed when an axis error occurs.	807	907	1007
5)	The axis warning No. is displayed when an axis warning occurs.	808	908	1008
6)	The M code (valid M code) that is set in the data during positioning is displayed.	806	906	1006
7)	Positioning data No. during positioning is displayed. (The actual data No. is also displayed when specified indirectly.)	835	935	1035
8) 9) 10) 11)	The positioning identifier of the positioning data during positioning is displayed.	838	938	1038

Bit 15 to 8 7 6 5 4 3 to 0

9)	11)	10)	8)
----	-----	-----	----

↑ Operation pattern  
 ↑ Acceleration time no.  
 ↑ Deceleration time no.  
 ↑ Data control method

12.23.3 Basic parameter monitor

(1) Basic parameter 1

AD75P		Basic Parameter 1			SET/ RESET	Data chg.	MONIT MENU	END
Parameter	Valid Range	1Axis	2Axis	3Axis				
1) Unit	0:mm 1:inch 2:degree 3:PULSE	0	0	0				
2) Pulse Per Revolution	1 to 65535 [PLS]	01234	01234	01234				
3) Travel Per Revolution	0 to 65535 [ $\times 10^{-1}$ $\mu$ m] [ $\times 10^{-5}$ inch] [ $\times 10^{-5}$ degree] [PLS]	01234	01234	01234				
4) Unit Multiplier	1: x1 10: x10 100: x100 1000: x1000	0123	0123	0123				
5) Pulse Output Mode	0:PLS/SIGN Mode 1:CW/CCW Mode 2:A/B Mode	0	0	0				
6) Rotation Direction	0:Forward Pulses 1:Reverse Pulses	0	0	0				

No.	Contents of display	Buffer memory address to reference (decimal)		
		Axis 1	Axis 2	Axis 3
1)	The command module for positioning control is displayed.	0	150	300
2)	The pulse number per 1 revolution of the motor determined by the machine system is displayed.	1	151	301
3)	The travel distance per 1 revolution of the motor determined by the machine system is displayed.	2	152	302
4)	The multiplier of the travel distance per 1 pulse is displayed.	3	153	303
5)	The pulse output mode is displayed.	4	154	304
6)	The direction of rotation when the current value is increased is displayed.	5	155	305

(2) Basic parameter 2

AD75P		Basic Parameter 2			SET/ RESET	Data Chg.	MONIT MENU	END
Parameter	Valid Range	1Axis	2Axis	3Axis				
1) Speed Limit	1 to 600000000 [ $\times 10^{-5}$ mm/min] 1 to 600000000 [ $\times 10^{-3}$ inch/min] 1 to 600000000 [ $\times 10^{-3}$ deg/min] 0 to 1000000 [PLS/sec]	012345678	012345678	012345678				
2) Accel.Time #0	1 to 65535 [msec]	01234	01234	01234				
3) Decel.Time #0	1 to 65535 [msec]	01234	01234	01234				

No.	Contents of display	Buffer memory address to reference (decimal)		
		Axis 1	Axis 2	Axis 3
1)	The maximum speed for the positioning operation (also including zero return) and the manual pulser operation is displayed.	6	156	306
		7	157	307
2)	With the positioning operation, the acceleration time 0 from speed 0 until the speed limit has been attained is displayed.	8	158	308
		9	159	309
3)	With the positioning operation, the deceleration time 0 from the speed limit to 0 speed is displayed.	10	160	310
		11	161	311



12.23.4 Extended parameter monitor

(1) Extended parameter 1

AD75P		Basic Parameter 2			SET/ RESET	Data Chg.	MONIT MENU	END
Parameter	Valid Range	1Axis	2Axis	3Axis				
1) Speed Limit	1 to 600000000 [ $\times 10^{-5}$ mm/min] 1 to 600000000 [ $\times 10^{-3}$ inch/min] 1 to 600000000 [ $\times 10^{-3}$ deg/min] 0 to 1000000 [PLS/sec]	012345678	012345678	012345678				
3) Acce1.Time #0	1 to 65535 [msec]	01234	01234	01234				
4) Decel.Time #0	1 to 65535 [msec]	01234	01234	01234				

No.	Contents of display	Buffer memory address to reference (decimal)		
		Axis 1	Axis 2	Axis 3
1)	The machine backlash compensation amount when the positioning direction changes is displayed.	15	165	315
2)	The upper limit of the range that the machine can travel is displayed. (Software stroke upper limit)	16	166	316
		17	167	317
3)	The lower limit of the range that the machine can travel is displayed. (Software stroke lower limit)	18	168	318
		19	169	319
4)	This shows whether the software stroke limit is applied to the feed current value or the feed machine value. Check the feed current value with the operation monitor (Sec. 12.23.1). Check the feed machine value with the target value and the machine value monitor (Sec. 12.23.13).	20	170	320
5)	This shows whether the software stroke limit for the jog operation and the manual pulser operation is enabled/disabled.	21	171	321
6)	The torque limit is displayed.	24	174	324

(2) Extended parameter 2

AD75P		Extended Parameter 2			SET/ RESET	Data Chg.	MONIT MENU	END
1)	Parameter	Valid Range	Axis1	Axis2	Axis3			
	Accel.Time#1	1 to 65535 [msec]	012345	012345	012345			
	Accel.Time#2	1 to 65535 [msec]	012345	012345	012345			
2)	Decel.Time#1	1 to 65535 [msec]	012345	012345	012345			
	Decel.Time#2	1 to 65535 [msec]	012345	012345	012345			
	Decel.Time#3	1 to 65535 [msec]	012345	012345	012345			

No.	Contents of display	Buffer memory address to reference (decimal)		
		Axis 1	Axis 2	Axis 3
1)	With the positioning operation, acceleration time 1 through acceleration time 3 from speed 0 until the speed limit is attained is displayed.	36 to 41	186 to 191	336 to 341
2)	With the positioning operation, deceleration time 1 through deceleration time 3 from the speed limit to 0 speed is displayed.	42 to 47	192 to 197	342 to 347

12.23.5 Zero return parameter monitor

(1) Basic parameters for zero return

AD75P		OPR Basic Parameter			SET/ RESET	Data Chg.	MONIT MENU	END
Parameter	Valid Range	1Axis	2Axis	3Axis				
1) Method	0:DOG 4:Count#1 1:Stopper#1 5:Count#2 2:Stopper#2 3:Stopper#3	0	0	0				
2) Direction	0:Forward 1:Reverse	0	0	0				
3) Address	-2147483648 to 2147483647 [ $\times 10^{-1}$ $\mu$ m] [ $\times 10^{-5}$ inch] [PLS] 0 to 35999999	01234567890	01234567890	01234567890				
4) Return Speed	1 to 600000000 [ $\times 10^{-2}$ mm/min] [ $\times 10^{-3}$ inch/mm] [ $\times 10^{-3}$ deg/mm] 1 to 1000000 [PLS/sec]	012345678	012345678	012345678				
5) Creep Speed	1 to 600000000 [ $\times 10^{-2}$ mm/min] [ $\times 10^{-3}$ inch/mm] [ $\times 10^{-3}$ deg/mm] 1 to 1000000 [PLS/sec]	012345678	012345678	012345678				
6) Return Retry	0:No Retry 1:retry	0	0	0				

No.	Contents of display	Buffer memory address to reference (decimal)		
		Axis 1	Axis 2	Axis 3
1)	The zero return method is displayed.	70	220	370
2)	The zero return direction is displayed. Forward: address increase direction Reverse: address decrease direction	71	221	371
3)	The zero address that is set when the zero return is complete is displayed.	72 73	222 223	372 373
4)	The maximum speed for the zero return is displayed.	74 75	224 225	374 375
5)	The creep speed after the near signal turns on is displayed. (speed before zero return is complete)	76 77	226 227	376 377
6)	This indicates whether or not to retry the zero return with the zero return retry function.	78	228	378

(2) Detailed parameters for origin return

AD75P		OPR Extended Parameter			SET/ RESET	Data Chg.	MONIT MENU	END
Parameter	Valid Range	1Axis	2Axis	3Axis				
1) OPR Dwell Time	0 to 65535 [msec]	01234	01234	01234				
2) OPR Torque Limit	1 to 300 [%]	012	012	012				
3) Travel Distance After DOG	0 to 2147483647 [ $\times 10^{-1}$ $\mu$ m] [ $\times 10^{-5}$ inch] [PLS]	0123456789	0123456789	0123456789				
4) OPR Accel. Time	0 to 3	0	0	0				
5) OPR Decel. Time	0 to 3	0	0	0				
6) OP Distance From Zero	-2147483648 to 2147483647 [ $\times 10^{-1}$ $\mu$ m] [ $\times 10^{-5}$ inch] [PLS] 0 to 35999999 [ $\times 10^{-5}$ deg]	01234567890	01234567890	01234567890				

No.	Contents of display	Buffer memory address to reference (decimal)		
		Axis 1	Axis 2	Axis 3
1)	The time from when the proximity dog goes ON to when the origin point return is completed is displayed. (for stopper stop 1)	79	229	379
2)	The restriction value used to limit the torque of the servomotor after reaching the creeping speed is displayed.	86	236	386
3)	The amount of movement after the proximity dog goes ON is displayed. (for count equation)	80 81	230 231	380 381
4)	The display shows which acceleration time, 0 to 3 (basically, this is set using the detailed parameters) is to be used as the acceleration time when making an origin point return.	82	232	382
5)	The display shows which deceleration time, 0 to 3 (basically, this is set using the detailed parameters) is to be used as the deceleration time when making an origin point return.	83	233	383
6)	The shift amount (amount of movement) for an origin point shift is displayed.	84 85	234 235	384 385

12.23.6 Monitoring the error history and warning history

AD75P
Error History . Warning History

SET/ RESET	Data chg.	MONIT MENU	END
---------------	--------------	---------------	-----

[ Error History ]

No.	Ax.	Code	Time
1	○	012	00:00:00.00
2	○	012	00:00:00.00
3	○	012	00:00:00.00
4	○	012	00:00:00.00
5	○	012	00:00:00.00
6	○	012	00:00:00.00
7	○	012	00:00:00.00
8	○	012	00:00:00.00
9	○	012	00:00:00.00
10	○	012	00:00:00.00
11	○	012	00:00:00.00
12	○	012	00:00:00.00
13	○	012	00:00:00.00
14	○	012	00:00:00.00
15	○	012	00:00:00.00
16	○	012	00:00:00.00

[ Warning History ]

No.	Ax.	Code	Time
1	○	012	00:00:00.00
2	○	012	00:00:00.00
3	○	012	00:00:00.00
4	○	012	00:00:00.00
5	○	012	00:00:00.00
6	○	012	00:00:00.00
7	○	012	00:00:00.00
8	○	012	00:00:00.00
9	○	012	00:00:00.00
10	○	012	00:00:00.00
11	○	012	00:00:00.00
12	○	012	00:00:00.00
13	○	012	00:00:00.00
14	○	012	00:00:00.00
15	○	012	00:00:00.00
16	○	012	00:00:00.00

1)
2)

No.	Contents of display	Buffer memory address to reference (decimal)		
		Axis 1	Axis 2	Axis 3
1)	The error history is displayed. Axis : No. of axis on which error occurred Code: Code for error which occurred (decimal) Time : Time at which error occurred	624 to 687 (624, 628..) (625, 629..) (626, 630..)		
2)	The warning history is displayed. Axis : No. of axis on which warning occurred Code: Code for warning which occurred (decimal) Time : Time at which warning occurred	689 to 752 (689, 693..) (690, 694..) (691, 695..)		

12.23.7 Monitoring the error temporary startup history and startup history

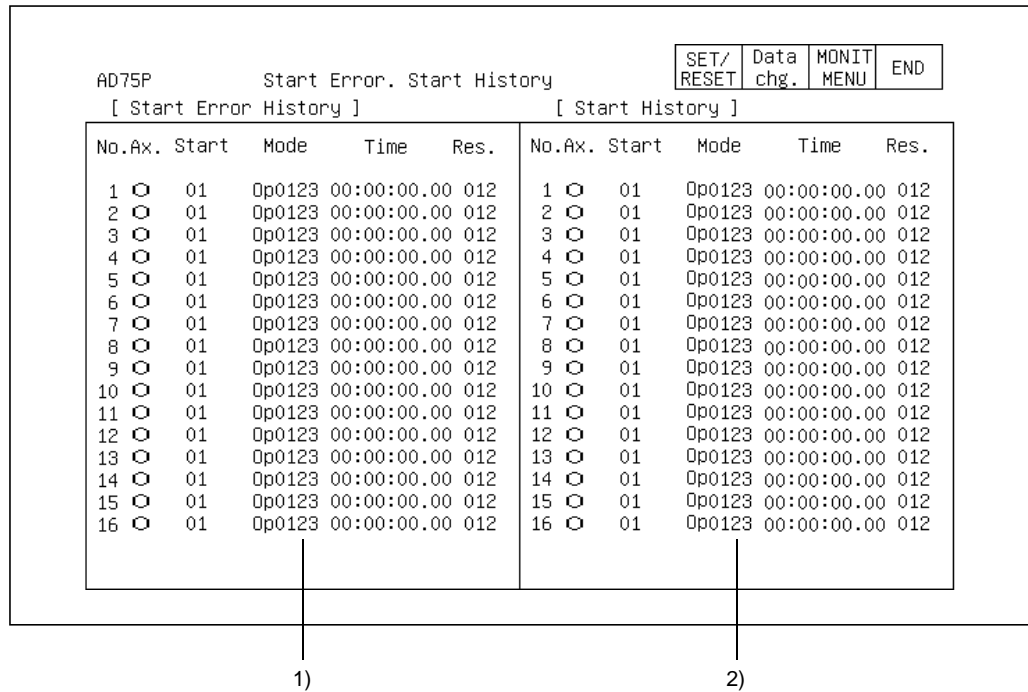

No.	Contents of display	Buffer memory address to reference (decimal)		
		Axis 1	Axis 2	Axis 3
1)	<p>The error startup history is displayed.</p> <p>Axis : Startup axis no.</p> <p>Startup source : Source which initiates startup (*1)                      00: PLC CPU (Y)                      01: External signal                      10: Peripheral equipment (AD75P)</p> <p>Type of operation : Type of operation at startup (*2)                      If restarting from a stopped status, "Re" is displayed just before this.</p> <p>Time : Startup time (hour: minutes: seconds: 100 milliseconds)</p> <p>Judgment : Error code when startup error occurred (decimal)                      The numeric values of the least significant 14 bits of the buffer memory are displayed.</p>	543 to 622 (543, 548..) (544, 549..)  (544, 549..)  (545 · 546, 550 · 551..) (547, 552..)		
2)	<p>The startup history is displayed.                      (The contents of the display are the same as in 1).)</p> <p>Axis : Startup axis no.</p> <p>Startup source : Source which initiates startup (*1)</p> <p>Type of operation : Type of operation at startup (*2)</p> <p>Time : Startup time (hour: minutes: seconds: 100 milliseconds)</p> <p>Judgment : Error code when startup error occurred (decimal)</p>	462 to 541  (462, 467..) (463, 468..) (463, 468..) (464 · 465, 469 · 470..) (466, 471..)		

- \*1 The display is based on the data in Bits 13 and 14 of the object buffer memory.
- \*2 The correspondence between the numeric value displayed in the "Operation Type" column and the type of startup is shown below. The display is based on the data in Bits 0 to 12 of the object buffer memory.

Data no.	Type of startup	Remarks
1 to 600	Startup with positioning operation	Indicates the data number at the time of startup
7000	Startup with block positioning operation	
8051	Startup with origin point return	
8052	Startup with high-speed origin point return	
8053	Startup with change in current value	
8160	Startup with jogging operation	
8161	Startup with manual pulser operation	

Items with the "Re" prefix are displayed based on the data of Bit 15 of the object buffer memory.

12.23.8 Monitoring Speed/Position Control

AD75P		Speed Position Control			
		SET/ RESET	Data chg.	MONIT MENU	END
		Axis1	Axis2	Axis3	
1)	Travel After Switch [ $\times 10^{-1}$ $\mu\text{m}$ ] [ $\times 10^{-5}$ inch] [ $\times 10^{-5}$ deg] [PLS]	01234567890	01234567890	01234567890	
2)	Travel Correction Register [ $\times 10^{-1}$ $\mu\text{m}$ ] [ $\times 10^{-5}$ inch] [ $\times 10^{-5}$ deg] [PLS]	01234567890	01234567890	01234567890	
3)	V/P Switch Latch	●	○	●	
4)	Switch Enabled 0:Disable 1:Enable	0	0	0	
5)	V-Control	○	●	●	

No.	Contents of display	Buffer memory address to reference (decimal)		
		Axis 1	Axis 2	Axis 3
1)	The address (amount of movement) for position control in speed/position changing control is displayed.	814 815	914 915	1014 1015
2)	The changed value is displayed when the position control address (amount of movement) in the speed control function is changed in speed/position changing control.	1164 1165	1214 1215	1264 1265
3)	The ON/OFF status of the speed/position changing latch flag (the flag indicating the control status) is displayed. (The status of Bit 1 of the pertinent buffer memory is displayed.) ● : Position control in progress ○ : Speed control in progress/positioning is in progress in another control method or operation method (such as jogging)	817	917	1017
4)	This displays whether control switching in response to an external signal is effective or not in speed/position changing control. 1 : Switching is permitted 0 : Switching is not permitted	1163	1213	1263
5)	The ON/OFF status flag during speed control (the flag indicating the control status) is displayed. (The status of Bit 0 of the pertinent buffer memory is displayed.) ● : Speed control in progress ○ : Position control in progress/positioning is in progress in another control method or operation method (such as jogging)	817	917	1017



12.23.9 Monitoring special startup, jogging, and manual pulser operation

AD75P SP Start JOG MPG Drive					SET/ RESET	Data chg.	MONIT MENU	END
[ Special Star ]								
	Operation	Information	Parameter	Data No.				
1) #1	012	01 H	012	0123				
#2	012	01 H	012	0123				
#3	012	01 H	012	0123				
[ JOG & MPG ]								
		Axis1	Axis2	Axis3				
2) JOG Speed	[ $\times 10^{-5}$ mm/min]: [ $\times 10^{-3}$ inch/min]: [ $\times 10^{-3}$ deg/min]: [PLS/sec]:	012345678	012345678	012345678				
3) MPG Magnify		012	012	012				
4) MPG Enabled	0:Disable 1:Enable	0	0	0				

No.	Contents of display	Buffer memory address to reference (decimal)		
		Axis 1	Axis 2	Axis 3
1)	The information for the special startup currently in progress is displayed. Operation : Startup data pointer Information : Command code of the special startup data specified by the startup data pointer Parameter : Parameters for the special startup data specified by the startup data pointer Data No. : Positioning data number specified by the startup data pointer	832 827 828 829	932 927 928 929	1032 1027 1028 1029
2)	The jogging speed used during jogging operation is displayed.	1160 1161	1210 1211	1260 1261
3)	The input magnification per one pulse from the manual pulser is displayed.	1168 1169	1218 1219	1268 1269
4)	The display shows whether or not manual pulser operation is permitted.	1167	1217	1267

12.23.10 Monitoring an origin point return

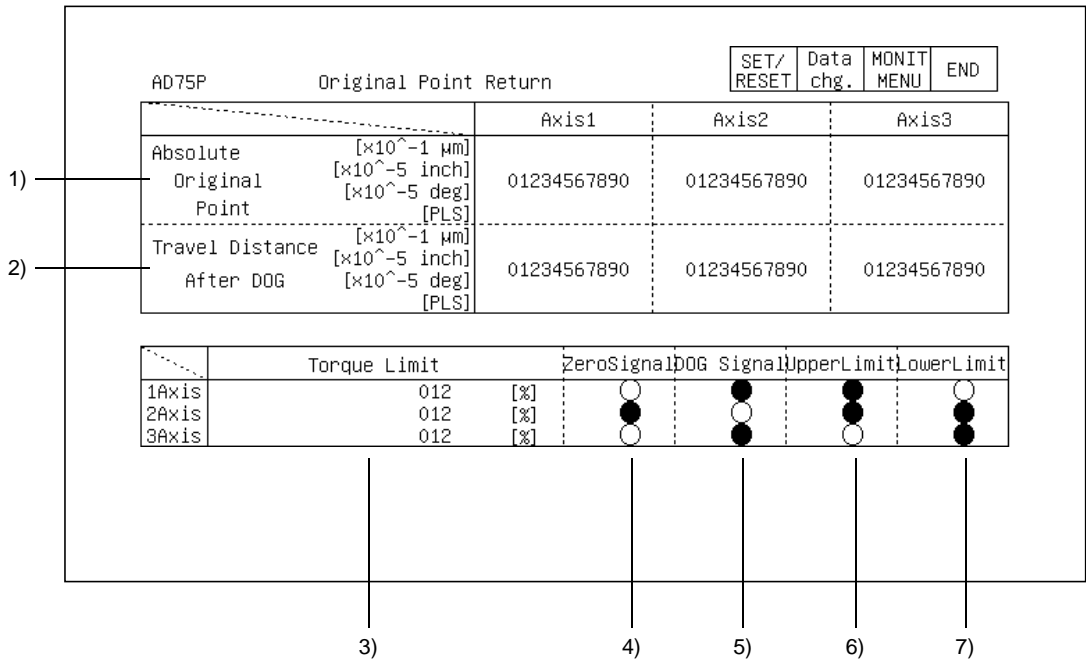

No.	Contents of display	Buffer memory address to reference (decimal)										
		Axis 1	Axis 2	Axis 3								
1)	The address of the origin point set when an origin point return is completed is displayed.	822 823	922 923	1022 1023								
2)	The amount of movement after the proximity dog goes ON is displayed.	824 825	924 925	1024 1025								
3)	The torque limit value is displayed.	826	926	1026								
4) 5) 6) 7)	The ON/OFF status of the external I/O signal corresponding to the signal name displayed on the screen is displayed. ○ : OFF ● : ON  <div style="display: flex; align-items: center;"> <div style="margin-right: 10px;">Bit 15 to</div> <div style="border: 1px solid black; padding: 2px;"> <table style="border-collapse: collapse; text-align: center;"> <tr> <td style="width: 15px;">7</td> <td style="width: 15px;">6</td> <td style="width: 15px;">5</td> <td style="width: 15px;">4</td> <td style="width: 15px;">3</td> <td style="width: 15px;">2</td> <td style="width: 15px;">1</td> <td style="width: 15px;">0</td> </tr> </table> </div> <div style="margin-left: 10px;"> <p>Zero point signal</p> <p>Proximity signal</p> <p>Upper limit</p> <p>Lower limit</p> </div> </div>	7	6	5	4	3	2	1	0	816	916	1016
7	6	5	4	3	2	1	0					

12.23.11 Monitoring axis control data

AD75P		Axis Control Data			SET/ RESET	Data chg.	MONIT MENU	END
		Axis1	Axis2	Axis3				
1)	Correcting Address	[ $\times 10^{-1}$ mm] [ $\times 10^{-5}$ inch] [ $\times 10^{-5}$ deg]	01234567890	01234567890	01234567890			
2)	Correcting Speed	[PLS] [ $\times 10^{-5}$ mm/min] [ $\times 10^{-3}$ inch/min] [ $\times 10^{-3}$ deg/min]	012345678	012345678	012345678			
3)	Speed Dump	[PLS/sec] [%]	012	012	012			
4)	Step Valid Flag	0:Disable 1:Enable	0	0	0			
5)	Step Mode	0:Dec Unit 1:Data No.	0	0	0			
6)	Skip Command	0:Completed 1:Req.	0	0	0			
7)	EXT.Start Enable	0:Disable 1:Enable	0	0	0			

No.	Contents of display	Buffer memory address to reference (decimal)		
		Axis 1	Axis 2	Axis 3
1)	The value for the current value change is displayed.	1154 1155	1204 1205	1254 1255
2)	The speed change value is displayed.	1156 1157	1206 1207	1256 1257
3)	The override value in relation to the positioning speed is displayed.	1159	1209	1259
4)	The ON/OFF status for the flag indicating whether step action is effective is displayed; this flag confirms the actions of the various positioning data in the step function. 1 : Step effective (step action is carried out) 0 : Step invalid (step action is not carried out)	1172	1222	1272
5)	This displays the module to be used for step action in operation based on the step function. 1 : Step action in data number modules 0 : Step action in reduced-speed modules	1173	1223	1273
6)	The ON/OFF status of the skip command is displayed. 1 : Request for skip in progress 0 : Request for skip has been completed/No request	1175	1225	1275
7)	The display shows whether control based on an external startup signal is effective or invalid. 1 : External startup effective 0 : External startup invalid	1171	1221	1271

12.23.12 Monitoring the output speed

AD75P		Output Speed			
		SET/ RESET	Data Chg.	MONIT MENU	END
		Axis1	Axis2	Axis3	
1)	Target Speed [ $\times 10^{-5}$ mm/min] [ $\times 10^{-3}$ inch/min] [ $\times 10^{-3}$ deg/min]	012345678	012345678	012345678	
2)	Current Speed [ $\times 10^{-5}$ mm/min] [ $\times 10^{-3}$ inch/min] [ $\times 10^{-3}$ deg/min]	012345678	012345678	012345678	
3)	Axis Speed [ $\times 10^{-5}$ mm/min] [ $\times 10^{-3}$ inch/min] [ $\times 10^{-3}$ deg/min]	012345678	012345678	012345678	

No.	Contents of display	Buffer memory address to reference (decimal)		
		Axis 1	Axis 2	Axis 3
1)	When positioning, the actual speed, taking the override and the speed limit value into consideration, is displayed. When using interpolation operation, the target speeds for the composite speed/reference axis speed are displayed on the reference axis side, and "0" is displayed on the other axis side. When using jogging operation, the actual speed taking the jogging speed limit value into consideration is displayed.	820 821	920 921	1020 1021
2)	The speed set for the positioning data is displayed. When using interpolation operation, the target speeds for the composite speed/reference axis speed are displayed on the reference axis side, and "0" is displayed on the other axis side.	810 811	910 911	1010 1011
3)	The actual positioning speed is displayed.	812 813	912 913	1012 1013

12.23.13 Monitoring the target values and machine values

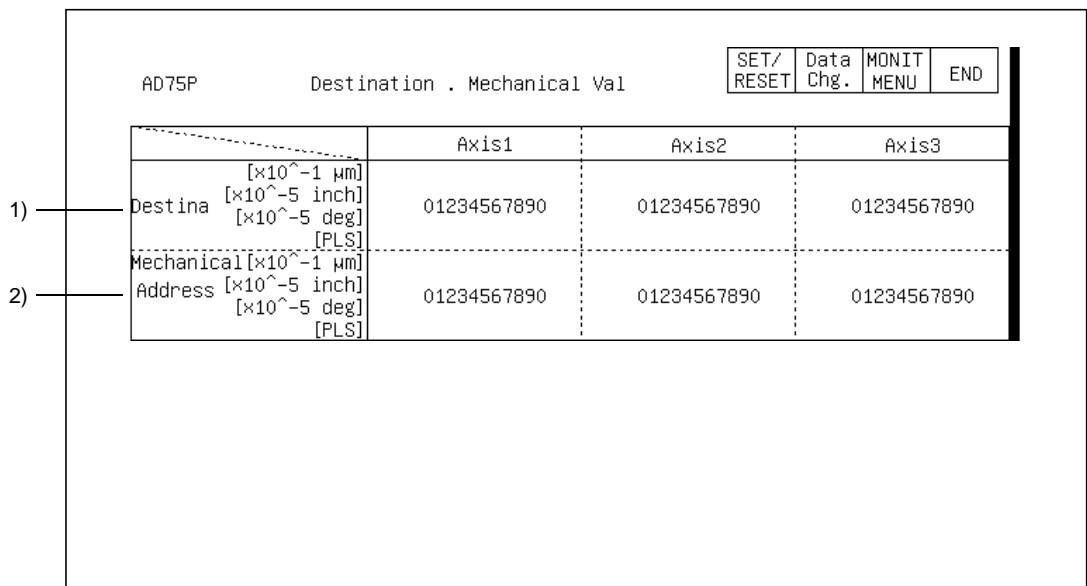

No.	Contents of display	Buffer memory address to reference (decimal)		
		Axis 1	Axis 2	Axis 3
1)	The object values when using positioning based on position control are displayed. (With ABS:adress/With INC:amount of movement)	818	918	1018
	When using speed/position changing control, the amount of movement following a change to position control is displayed.	819	919	1019
2)	The individual position determined by the machine is used as the machine origin point, and the current machine feed value (position)is displayed.	802	902	1002
		803	903	1003

12.23.14 Monitoring external I/O signals and status signals (flags)

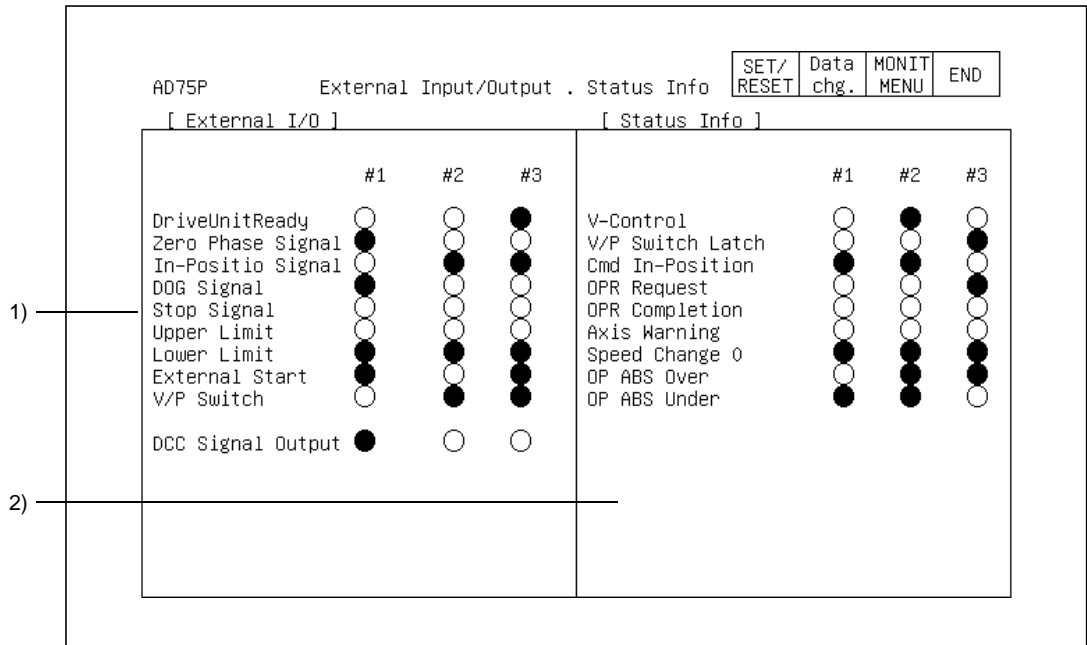

No.	Contents of display	Buffer memory address to reference (decimal)		
		Axis 1	Axis 2	Axis 3
1)	<p>The ON/OFF status for the external I/O signal corresponding to the signal name shown on the screen is displayed.</p> <p>○ : OFF ● : ON</p> <p>Bit 15 to 9 8 7 6 5 4 3 2 1 0</p>	816	916	1016
2)	<p>The ON/OFF status for the various flags corresponding to the flag shown on the screen is displayed.</p> <p>○ : OFF ● : ON</p> <p>Bit 15 to 12 11 10 9 to 4 3 2 1 0</p>	817	917	1017

## 12. OPERATION OF EACH SPECIAL MODULE MONITOR SCREEN

MELSEC GOT

### 12.23.15 Monitoring positioning information

AD75P Positioning Information Monitor Screen No. 1														
<div style="text-align: right;"> <table border="1" style="display: inline-table; border-collapse: collapse;"> <tr> <td style="padding: 2px;">SET/ RESET</td> <td style="padding: 2px;">Data chg.</td> <td style="padding: 2px;">MONIT MENU</td> <td style="padding: 2px;">END</td> </tr> </table> </div>											SET/ RESET	Data chg.	MONIT MENU	END
SET/ RESET	Data chg.	MONIT MENU	END											
No.	Pat rn	Me thod	▲	▼	Address	Arc Address	Speed	Dwell Time	M Code					
1)	Ax 1	1	01	01	01	01	01234567890	01234567890	012345678	01234	01234			
		2	01	01	01	01	01234567890	01234567890	012345678	01234	01234			
		3	01	01	01	01	01234567890	01234567890	012345678	01234	01234			
		4	01	01	01	01	01234567890	01234567890	012345678	01234	01234			
		5	01	01	01	01	01234567890	01234567890	012345678	01234	01234			
2)	Ax 2	1	01	01	01	01	01234567890	01234567890	012345678	01234	01234			
		2	01	01	01	01	01234567890	01234567890	012345678	01234	01234			
		3	01	01	01	01	01234567890	01234567890	012345678	01234	01234			
		4	01	01	01	01	01234567890	01234567890	012345678	01234	01234			
		5	01	01	01	01	01234567890	01234567890	012345678	01234	01234			
3)	Ax 3	1	01	01	01	01	01234567890	01234567890	012345678	01234	01234			
		2	01	01	01	01	01234567890	01234567890	012345678	01234	01234			
		3	01	01	01	01	01234567890	01234567890	012345678	01234	01234			
		4	01	01	01	01	01234567890	01234567890	012345678	01234	01234			
		5	01	01	01	01	01234567890	01234567890	012345678	01234	01234			

No.	Contents of display	Buffer memory address to reference (decimal)
1)	<p>The positioning data corresponding to the data number and data name shown on the screen for Axis 1 is displayed.</p> <p>Pattern : This is displayed based on Bits 0 to 1 of the applicable buffer memory address.</p> <p>Control method :</p> <p>Acceleration :</p> <p>Deceleration :</p> <p>Address :</p> <p>Arc address :</p> <p>Specified speed :</p> <p>Dwell time :</p> <p>M code :</p>	<p>1300 to 2299</p> <p>(1300, 1310···)</p> <p>(1300, 1310···)</p> <p>(1300, 1310···)</p> <p>(1300, 1310···)</p> <p>(1306 · 1307, 1316 · 1317···)</p> <p>(1308 · 1309, 1318 · 1319···)</p> <p>(1304, 1314···)</p> <p>(1302, 1312···)</p> <p>(1301, 1311···)</p>
2)	<p>The positioning data corresponding to the data number and data name shown on the screen for Axis 2 is displayed.</p> <p>Pattern : (The contents of the display are the same as for 1.)</p> <p>Address :</p> <p>Arc address :</p> <p>Dwell time :</p> <p>M code :</p>	<p>2300 to 3299</p> <p>(2300, 2310···)</p> <p>(2306 · 2307, 2316 · 2317···)</p> <p>(2308 · 2309, 2318 · 2319···)</p> <p>(2302, 2312···)</p> <p>(2301, 2311···)</p>
3)	<p>The positioning data corresponding to the data number and data name shown on the screen for Axis 3 is displayed.</p> <p>Pattern : (The contents of the display are the same as for 1.)</p> <p>Address :</p> <p>Arc address :</p> <p>Dwell time :</p> <p>M code :</p>	<p>3300 to 4299</p> <p>(3300, 3310···)</p> <p>(3306 · 3307, 3316 · 3317···)</p> <p>(3308 · 3309, 3318 · 3319···)</p> <p>(3302, 3312···)</p> <p>(3301, 3311···)</p>

12.24 AJ71PT32-S3 and A1SJ71PT32-S3 module monitor

The contents displayed on the monitor screens of the AJ71PT32-S3 and A1SJ71PT32-S3 modules are the same, except for the section where the module model name is displayed.

In this section, we will look at the monitor screens for the AJ71PT32-S3.

12.24.1 I/O monitor (I/O mode)

AJ71PT32-S3 I/O Monitor Scr. (I/O Dedicated Mode)				SET/ RESET	Data Chg.	MONIT MENU	END
Inputs (X)			Outputs (Y)				
00	Hardware Fault	10	00	10			
01	Link Working	11	01	11			
02		12	02	12			
03		13	03	13			
04		14	04	14			
05	Test Mode	15	05	15			
06	Link Error Detect	16	06	16			
07	Link Comms. Error	17	07	17			
08		18	08	18	Link Comms.Start		
09		19	09	19			
0A		1A	0A	1A	FROM/TO Response		
0B		1B	0B	1B	Faulty Sta.Clear		
0C		1C	0C	1C			
0D		1D	0D	1D	Error Reset		
0E		1E	0E	1E			
0F		1F	0F	1F			

No.	Contents of display
1)	The ON/OFF status of the I/O signal corresponding to the PLC CPU of the master module is displayed. The I/O signal is ON when displayed in a reversed display.



## 12. OPERATION OF EACH SPECIAL MODULE MONITOR SCREEN

MELSEC GOT

### 12.24.2 Monitoring the link status

		SET/ RESET	Data Chg.	MONIT MENU	END	
AJ71PT32-S3 Link Data Monitor Screen						
1)	No. of Remote Stations 01	Communication Error Code 01				4)
Remote I/O Units Card Data		Accumulative Faulty Station Detection 0: Normal 1: Error				
ST : 8 7 6 5 4 3 2 1		FEDCBA9876543210				
8 - 10110110110110110		16- 10110110110110110				5)
16 - 90110110110110110		32-170110110110110110				
24 - 170110110110110110		48-330110110110110110				6)
32 - 250110110110110110		64-490110110110110110				
40 - 330110110110110110		Faulty Station Detection				
48 - 410110110110110110		FEDCBA9876543210				
56 - 490110110110110110		16- 10110110110110110				7)
64 - 570110110110110110		32-170110110110110110				
Card Data: 00 No remote unit or no initial communication		48-330110110110110110				8)
01 Input, partial refresh or remote terminal		64-490110110110110110				
10 Output remote unit		Accumulative Input Error Detection for Partial Refresh				
Remote Terminal Unit Faulty Station		FEDCBA9876543210				
No. FEDCBA9876543210		0110110110110110				
0110110110110110		Input Faulty Error Detection for Partial Refresh				
FEDCBA9876543210		FEDCBA9876543210				
0110110110110110		0110110110110110				

No.	Contents of display	Buffer memory address to reference (decimal)
1)	The total number of remote stations connected is displayed.	0
2)	This shows whether the station number of the connected remote module is for input or output.	70 to 77
3)	A "1" is displayed for the remote terminal module number where the error has occurred.	195
4)	When an error occurs in link communications, the communications error code is displayed. 0: No error    1: Initial data error 2: Ladder error    3: Erroneous station issued 4: Separate refresh type remote I/O module error	107
5)	A communications error has occurred, and a "1" is displayed for the station number of the remote module. The detection status is maintained until the error is reset.	90 to 93
6)	A communications error has occurred, and a "1" is displayed for the station number of the remote module. If the automatic recovery function is on, a "0" is displayed when normal communications have been resumed.	100 to 103
7)	A "1" is displayed for the station number of a separate refresh type remote I/O module where the input information could not be read out within a given time period. The detection status is maintained until the error is reset.	598
8)	A "1" is displayed for the station number of a separate refresh type remote I/O module where the input information could not be read out within a given time period. If the automatic recovery function is on, a "0" is displayed when the station is able to read the input normally.	599





## 12. OPERATION OF EACH SPECIAL MODULE MONITOR SCREEN

MELSEC GOT

### 12.24.5 Monitoring input and output (expansion mode)

1) —

AJ71PT32-S3 I/O Monitor Screen (Extension Mode)				SET/ RESET	Data Chg.	MONIT MENU	END
Inputs (X)				Outputs (Y)			
00	Tx.Complete No.1	16	Tx.Complete No.12	00	Tx.Request No.1	16	Tx.Request No.12
01	Read Request	17	Read Request	01	Read Complete	17	Read Complete
02	Tx.Complete No.2	18	Tx.Complete No.13	02	Tx.Request No.2	18	Tx.Request No.13
03	Read Request	19	Read Request	03	Read Complete	19	Read Complete
04	Tx.Complete No.3	1A	Tx.Complete No.14	04	Tx.Request No.3	1A	Tx.Request No.14
05	Read Request	1B	Read Request	05	Read Complete	1B	Read Complete
06	Tx.Complete No.4			06	Tx.Request No.4		
07	Read Request			07	Read Complete		
08	Tx.Complete No.5	20	Hardware Fault	08	Tx.Request No.5	20	
09	Read Request	21	Link Working	09	Read Complete	21	
0A	Tx.Complete No.6	22		0A	Tx.Request No.6	22	
0B	Read Request	23	RxDData Clear Comp	0B	Read Complete	23	RxDData Clear Req.
0C	Tx.Complete No.7	24	RTU Error Detect	0C	Tx.Request No.7	24	RTU Error Clear
0D	Read Request	25	Test Mode	0D	Read Complete	25	
0E	Tx.Complete No.8	26	Link Error	0E	Tx.Request No.8	26	
0F	Read Request	27	Link Comms. Error	0F	Read Complete	27	
10	Tx.Complete No.9	28	ROM Error	10	Tx.Request No.9	28	Link Comms.Start
11	Read Request	29		11	Read Complete	29	
12	Tx.Complete No.10	2A		12	Tx.Request No.10	2A	FROM/TO Response
13	Read Request	2B		13	Read Complete	2B	Faulty Sta.Clear
14	Tx.Complete No.11	2C		14	Tx.Request No.11	2C	Switch BM Chann.
15	Read Request	2D		15	Read Complete	2D	Error Reset

No.	Contents of display
1)	The ON/OFF status for the I/O signal corresponding to the PLC CPU of the master module is displayed. An I/O signal is ON when it is displayed in a reverse display.

## 12. OPERATION OF EACH SPECIAL MODULE MONITOR SCREEN

MELSEC GOT

### 12.25 AJ71ID1 (ID2)-R4 and A1SJ71ID1 (ID2)-R4 module monitor

#### 12.25.1 Action monitor (CH 1 and CH 2)

AJ71ID		Movement Monitor Screen CH1				SET/ RESET	Data Chg.	MONIT MENU	END
Addr	Data	Addr	Data	Addr	Data	Addr	Data		
K 100	H 0123	K 116	H 0123	K 132	H 0123	K 148	H 0123		
K 101	H 0123	K 117	H 0123	K 133	H 0123	K 149	H 0123		
K 102	H 0123	K 118	H 0123	K 134	H 0123	K 150	H 0123		
K 103	H 0123	K 119	H 0123	K 135	H 0123	K 151	H 0123		
K 104	H 0123	K 120	H 0123	K 136	H 0123	K 152	H 0123		
K 105	H 0123	K 121	H 0123	K 137	H 0123	K 153	H 0123		
K 106	H 0123	K 122	H 0123	K 138	H 0123	K 154	H 0123		
K 107	H 0123	K 123	H 0123	K 139	H 0123	K 155	H 0123		
K 108	H 0123	K 124	H 0123	K 140	H 0123	K 156	H 0123		
K 109	H 0123	K 125	H 0123	K 141	H 0123	K 157	H 0123		
K 110	H 0123	K 126	H 0123	K 142	H 0123	K 158	H 0123		
K 111	H 0123	K 127	H 0123	K 143	H 0123	K 159	H 0123		
K 112	H 0123	K 128	H 0123	K 144	H 0123	K 160	H 0123		
K 113	H 0123	K 129	H 0123	K 145	H 0123	K 161	H 0123		
K 114	H 0123	K 130	H 0123	K 146	H 0123	K 162	H 0123		
K 115	H 0123	K 131	H 0123	K 147	H 0123	K 163	H 0123		

1)

No.	Contents of display	Buffer memory address to reference (decimal)	
		CH1	CH2
1)	The contents of the data storage area are displayed in address modules. (The illustration above shows the results when the CH 1 side is monitored.) (Addresses are displayed in decimal format and data in hexadecimal format.)	100 to 163	4100 to 4163

12.25.2 I/O monitor

AJ71ID      Input/Output Monitor Screen

	X		Y
00	WDT Error	10	00
01		11	01
02		12	02
03	CH1 ID-BUSY	13	03
04	ID-CommandComplete	14	04 CH1 ID-Command Exe
05	ID-Error	15	05
06	ID-READY	16	06
07		17	07
08		18	08
09		19	09
0A		1A	0A
0B	CH2 ID-BUSY	1B	0B
0C	ID-CommandComplete	1C	0C CH2 ID-Command Exe
0D	ID-Error	1D	0D
0E		1E	0E
0F		1F	0F

1) ———→

No.	Contents of display
1)	The ON/OFF status for the I/O signal corresponding to the PLC CPU is displayed. An I/O signal is ON when it is displayed in a reverse display.

12.25.3 Monitoring set information

AJ71ID Set Up Information Monitor Screen		SET/ RESET	Data chg.	MONIT MENU	END
		Valid range	CH1	CH2	
1)	ID Command		Continual Write	Comparison Write	
2)	Address. Data	0~4094 · 1~3900	K 0123 · K 0123Word	K 0123 · K 0123Word	
3)	Retry	0~32767	01234	01234	
4)	Total Communica.		0123456789	0123456789	
5)	Comparison		<input type="checkbox"/> Disagreement <input checked="" type="checkbox"/> OFF	<input checked="" type="checkbox"/> Disagreement <input type="checkbox"/> OFF	
6)	Copy direction	12: CH1 → CH2 21: " ← "	CH1 → CH2		
7)	LED Status		<input checked="" type="checkbox"/> DC24V <input type="checkbox"/> IDERR <input type="checkbox"/> ERR	<input checked="" type="checkbox"/> DC24V <input type="checkbox"/> IDERR <input type="checkbox"/> ERR	
8)	Err Record Latst  Past1 Past2 Past3 Past4	Execution Word Number Error		Data Career Absent Error	
		Execution Address Error Write Incompletion Error Set Up Address Error Set Up Word Number Error		Data Career Communicate Error Command Execution Error Command Code Error Communicate Condition Error	

No.	Contents of display	Buffer memory address to reference (decimal)	
		CH1	CH2
1)	The output command for the data carrier is displayed.	0	4000
2)	The first address for the data carrier which is reading and writing the data is displayed, along with the number of processing points for the data being read and written.	1	4001
		2	4002
3)	The number of retries when a data communications error occurs is displayed.	8	4008
4)	The number of communications (accumulated number of times) for the data carrier is displayed (excluding the CM, CL, OF, and ON commands).	22	4022
		23	4023
5)	The results of executing the compare command (CM) are displayed.	4	4004
		5	4005
6)	The direction in which data is copied when the copy data command (CO) is executed is displayed.	—	4010
7)	The lighting status of the error LED is displayed. (A "■" is displayed when an error occurs.)	12	4012
8)	The error codes for the five most recent times that an error has occurred is displayed.	14 to 18	4014 to 4018

12.26 A84AD module monitor

12.26.1 Action monitor

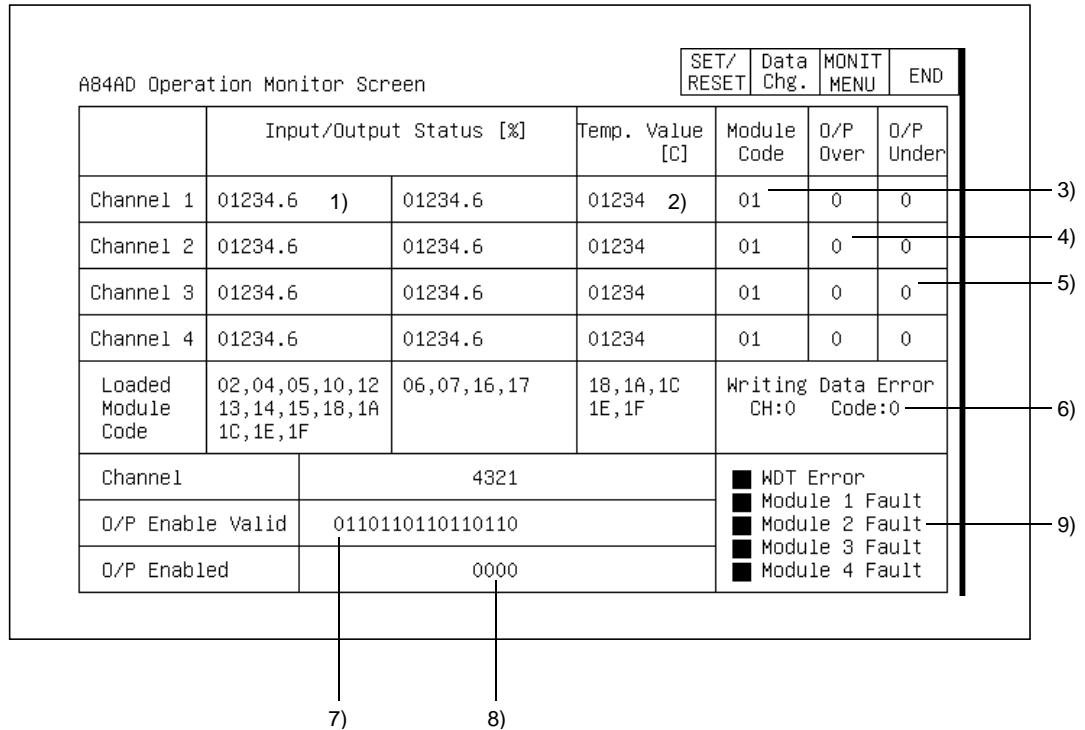

No.	Contents of display	Buffer memory address to reference (decimal)
1)	The current I/O data, a value between 0 to 1000 or 0 to 2000 for the digital I/O value of the various channels, is displayed as a percentage ranging from 0 to 100%, in the corresponding module code column.	10 to 13
2)	The temperature detection values for the various channels are displayed.	18 to 21
3)	The codes for installed modules for the various channels are displayed.	28 to 31
4)	If the digital values for the various channels have been set to values larger than the maximum value for the various modules, a "1" is displayed in the "Output Over" column.	22 to 25
5)	If the digital values for the various channels have been set to values smaller than the maximum value for the various modules, a "1" is displayed in the "Output Under" column.	22 to 25
6)	If an error occurs in the data being written, the channel on which the error occurred, and the error code, are displayed.	26
7)	The specified effective/invalid status for the analog output enable signal for each of the channels is displayed. 0: Effective    1: Invalid	27
8)	The specified status for the output enable command of each of the channels is displayed. 0: The offset value is output as an analog value. 1: The analog value following D/A conversion is output.	—
9)	A "■" is displayed when a watchdog timer error occurs. A "■" is displayed when an error occurs in a module on the various channels.	—



12.26.2 Setting monitor

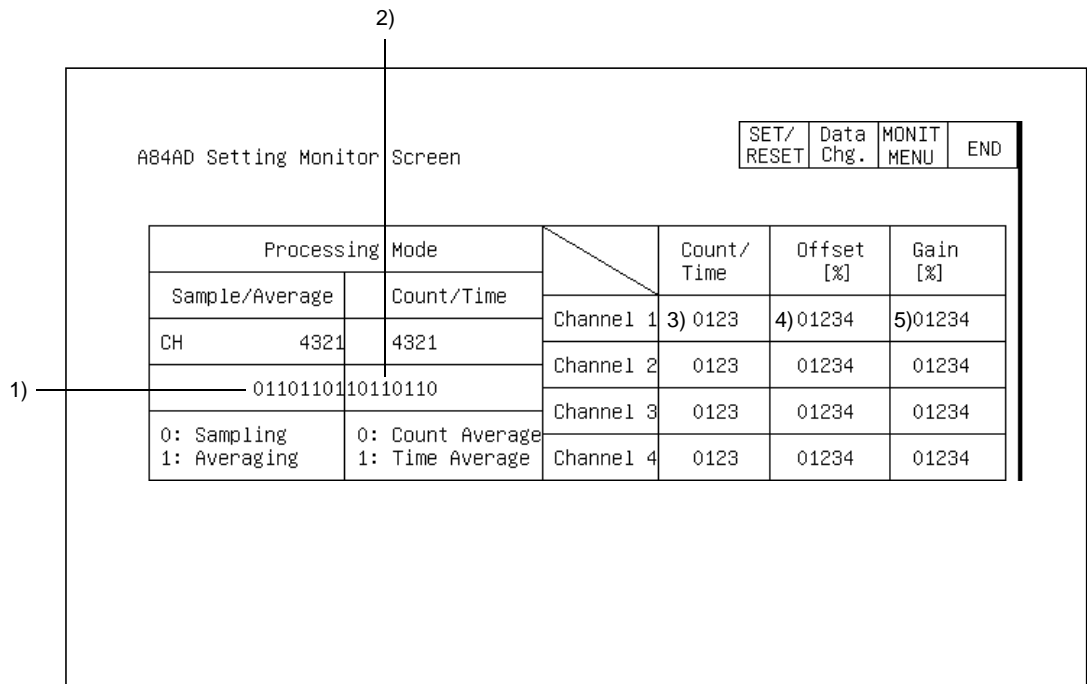

No.	Contents of display	Buffer memory address to reference (decimal)
1)	The specified status for the averaging processing/sampling processing of each of the channels is displayed.	1
2)	The specified status for the averaging processing of each of the channels is displayed.	1
3)	The values set for the time and number of times for averaging processing of each of the channels is displayed.	2 to 5
4)	When a temperature sensor input module is installed, the offset values for each of the channels is displayed.	32,34,36,38
5)	When a temperature sensor input module is installed, the gain values for each of the channels is displayed.	33,35,37,39

12.26.3 I/O monitor

A84AD Input/Output Monitor Screen

Inputs (X)				Outputs (Y)			
00	10	WDT Error	20	00	10	20	CH1 Enabled
01	11	READY	21	01	11	21	CH2 Enabled
02	12	CH1 Mod. Fault	22	02	12	22	CH3 Enabled
03	13	CH2 Mod. Fault	23	03	13	23	CH4 Enabled
04	14	CH3 Mod. Fault	24	04	14	24	
05	15	CH4 Mod. Fault	25	05	15	25	
06	16		26	06	16	26	
07	17		27	07	17	27	
08	18		28	08	18	28	
09	19		29	09	19	29	
0A	1A		2A	0A	1A	2A	
0B	1B		2B	0B	1B	2B	
0C	1C		2C	0C	1C	2C	
0D	1D		2D	0D	1D	2D	
0E	1E		2E	0E	1E	2E	
0F	1F		2F	0F	1F	2F	

1) —

No.	Contents of display
1)	The ON/OFF status for the I/O signal corresponding to the PLC CPU is displayed. An I/O signal is ON when it is displayed in a reverse display.

12.26.4 Monitoring graphs

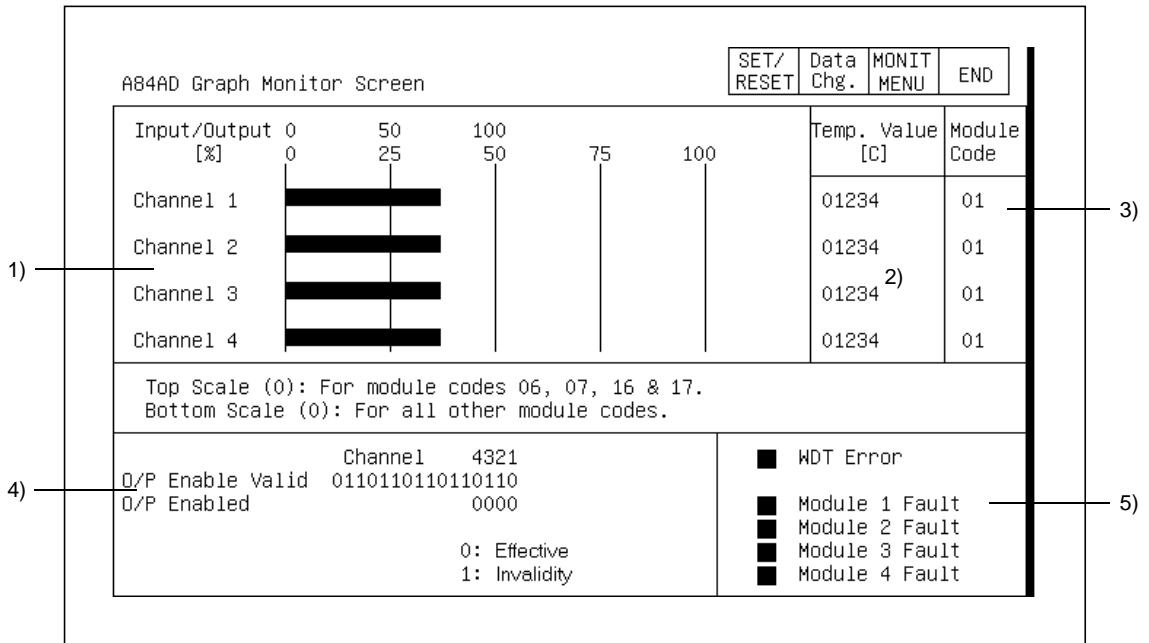

No.	Contents of display	Buffer memory address to reference (decimal)
1)	The current I/O value, a value between 0 to 1000 or 0 to 2000 for the digital I/O value of the various channels, is displayed as a percentage ranging from 0 to 100%	10 to 13
2)	The temperature detection values for the various channels are displayed.	18 to 21
3)	The module codes for installed modules for the various channels are displayed.	28 to 31
4)	The specified effective/invalid status for the analog output enable signal for each of the channels is displayed. 0: Effective 1: Invalid	27
	The specified status for the output enable command of each of the channels is displayed. 0: The offset value is output as an analog value. 1: The analog value following D/A conversion is output.	—
9)	A "■" is displayed when a watchdog timer error occurs.	—
	A "■" is displayed when an error occurs in a module on the various channels.	—

12.27. A1S64TCTT(BW)-S1 and A1S64TCRT(BW)-S1 module monitor

12.27.1 Operation monitor

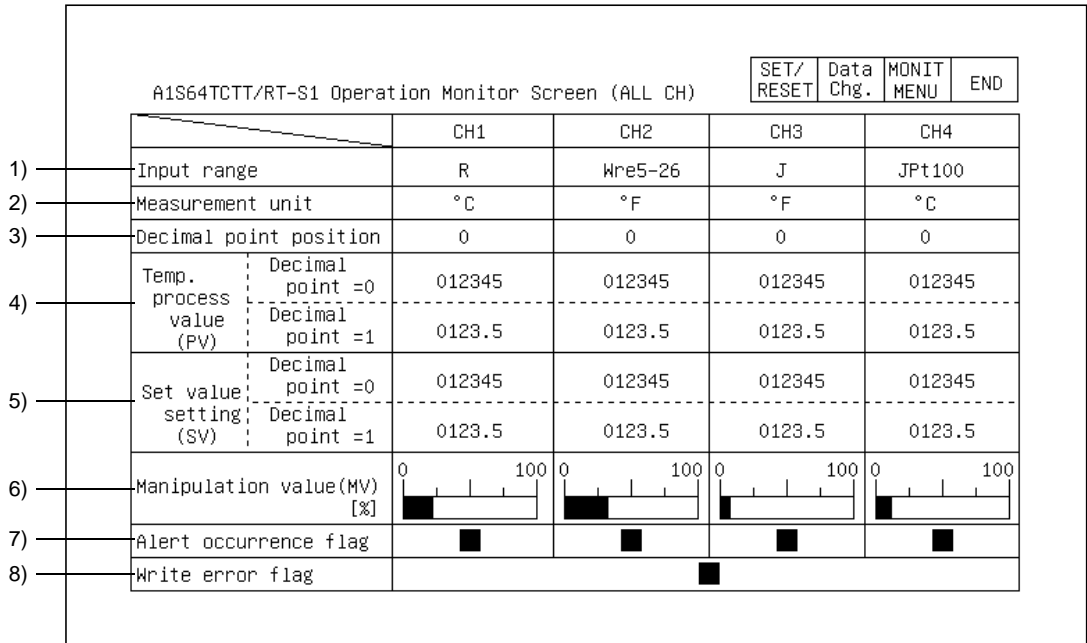

No.	Contents of display	Buffer memory address to reference (hexadecimal)				
		CH1	CH2	CH3	CH4	
1)	The type of the thermocouple connected to each channel is displayed.	20	40	60	80	
2)	The temperature measurement unit set for each channel is displayed.	20	40	60	80	
3)	The decimal position information of the temperature measurement value, goal value, and warning setting value for the input range and temperature measurement unit setting are displayed.					
		Display	When reading from PLC CPU	When writing from PLC CPU		
		When 0	Use the data from buffer memory as is.	Write the value to be specified directly as is.	01	02
	When 1	Use the 1/10th of the data read as actual value.	Write the value to be specified as 10 times the value.	03	04	
4)	The measured temperature (PV value) detected for each channel is displayed. In the decimal point position = 0 column, the value of the detected measured temperature is displayed as is. In the decimal point position = 1 column, the value 1/10th of the detected measured temperature is displayed.	09	0A	0B	0C	
5)	The goal value (SV value) set for each channel is displayed. In the decimal point position = 0 column, the value of the set goal value is displayed as is. In the decimal point position = 1 column, the 1/10th of the set goal value is displayed.	22	42	62	82	
6)	The PID-calculated values (-5.0% to 105.0%) of the temperature values read from the thermocouple of each is displayed in the graph.	0D	0E	0F	10	
7)	A "■" is displayed when a warning is indicated in each channel. The details of the warning can be verified in the warning occurrence details monitor screen.	—				
8)	A "■" is displayed when out-of-range data is stored in the temperature adjustment module buffer memory.	—				

12.27.2 Alert detail monitor

A1S64TCTT/RT-S1 Alert details					SET/ RESET	Data Chg.	MONIT MENU	END
	CH1	CH2	CH3	CH4				
PV exceeds the specified temperature measurement range in the input range.	■	■	□	■				
PV is below the specified temperature measurement range in the input range.	□	■	■	■				
Hardware error occurs.	■	□	□	□				
Alert alarm 1 is turned on.	□	■	■	■				
Alert alarm 2 is turned on.	■	■	□	□				
Alert alarm 3 is turned on.	□	□	□	□				
Alert alarm 4 is turned on.	□	□	□	■				
The heater disconnection alarm is detected.	■	□	□	□				
The loop disconnection is detected.	□	■	□	□				
The "current error when the output is off" is detected.	□	□	□	□				

1) {

No.	Contents of display	Buffer memory address to reference (hexadecimal)			
		CH1	CH2	CH3	CH4
1)	A "■" is displayed in the column corresponding to the warning details detected for each channel.	05	06	07	08

12.27.3 Operation monitor (CH1 to CH4)

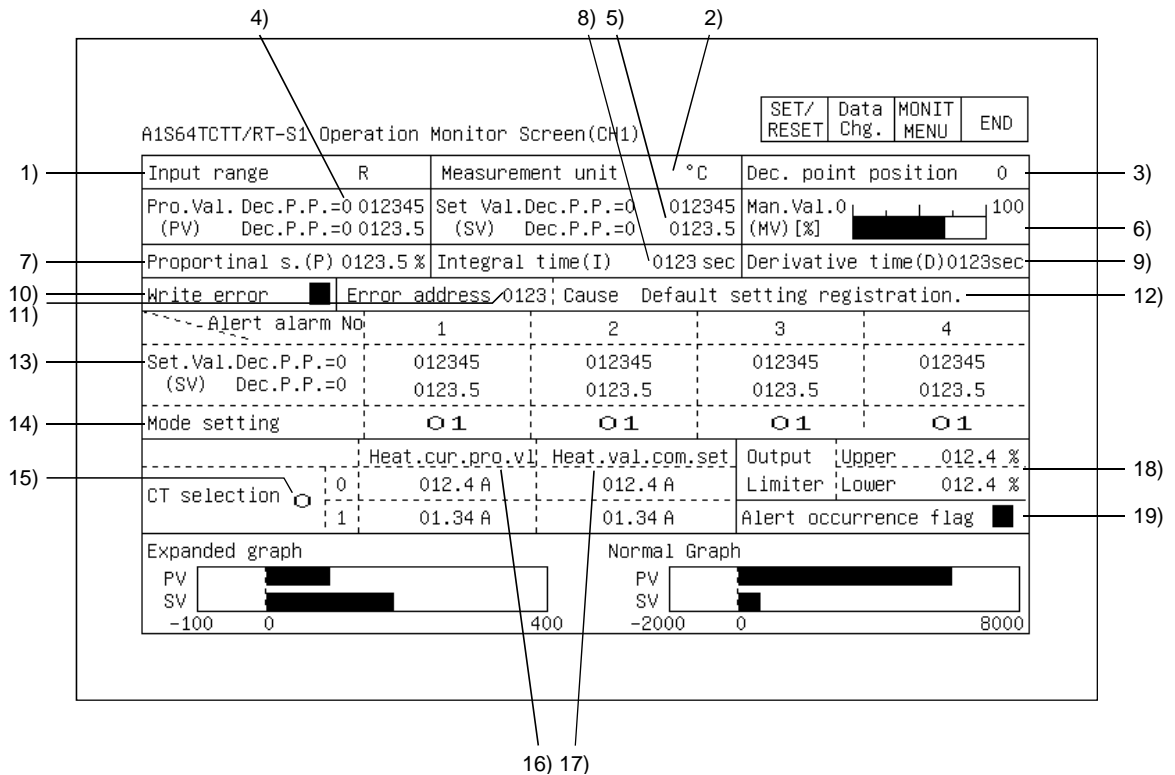

No.	Contents of display	Buffer memory address to reference (hexadecimal)					
		CH1	CH2	CH3	CH4		
1)	The type of the thermocouple connected to each channel is displayed.	20	40	60	80		
2)	The temperature measurement unit set for each channel is displayed.	20	40	60	80		
3)	The decimal position information of the temperature measurement value, goal value, and warning setting value for the input range and temperature measurement unit setting are displayed.		01	02	03	04	
	Display	When reading from PLC CPU					When writing from PLC CPU
	When 0	Use the data from buffer memory as is.					Write the value to be specified directly as is.
When 1	Use the 1/10th of the data read as actual value.	Write the value to be specified as 10 times the value.					
4)	The measured temperature (PV value) detected for each channel is displayed.		09	0A	0B	0C	
	In the decimal point position = 0 column, the value of the detected measured temperature is displayed as is. In the decimal point position = 1 column, the value 1/10th of the detected measured temperature is displayed.						
5)	The goal value (SV value) set for each channel is displayed.		22	42	62	82	
	In the decimal point position = 0 column, the value of the set goal value is displayed as is. In the decimal point position = 1 column, the 1/10th of the set goal value is displayed.						
6)	The PID-calculated values (-5.0% to 105.0%) of the temperature values read from the thermocouple of each is displayed in the graph.	0D	0E	0F	10		

No.	Contents of display	Buffer memory address to reference (hexadecimal)			
		CH1	CH2	CH3	CH4
7)	The ratio range (P) which is set in the PID constant setting of each channel is displayed. When 0, the 2-position control is set.	23	43	63	83
8)	The integral time (I), set in the PID constant setting of each channel is displayed.	24	44	64	84
9)	The derivative time (D), set in the PID constant setting of each channel is displayed. When 0, the PI control is set.	25	45	65	85
10)	A "■" is displayed when out-of-range data is stored in the temperature adjustment module buffer memory.	—			
11)	The buffer memory address for which an error was detected during the performance of a write to the temperature adjustment module buffer memory is displayed.	0			
12)	The details of the error detected during the performance of a write to the temperature adjustment module buffer memory is displayed.	0			
13)	The temperatures for which the warning alarms 1 to 4 set for each channel turns on are displayed.	26 to 29	46 to 49	66 to 69	86 to 89
14)	The warning mode of warning alarm 1 to 4 set for each channel are displayed.	A0 to A3			
15)	The current sensors connected to each channel are displayed. 0: When using CTL-12-S36-8 1: When using CTL-6-P (When using A1S64TCRTBW-S1 or A1S64TCTTBW-S1)	39	59	79	99
16)	The heater currents detected for each channel are displayed.	19	1A	1B	1C
17)	The standard heater current values set for each channel are displayed.	AB	AC	AD	AE
18)	The upper/lower limits for when the movement value (MV) which are calculated with the PID calculation set for each channel is outputted to the external device are displayed.	2A 2B	4A 4B	6A 6B	8A 8B
19)	A "■" is displayed when a warning occurs for each channel.	—			

Chapter13 Operating I/O module monitor screens

This section explains how the various screens are operated in the special module monitor function, when monitoring input or output modules.

13.1 Specifying the module to be monitored

This describes how to start monitoring an optional special input or output module.

[Operation procedure]

Display the System Configuration screen. .... See Sec. 12.1.1.

Specify the module to be monitored (Touch the position at which the module is displayed.)

- (1) Of the modules installed in Slot 0 to Slot 7 of the base unit, specify a module for which "Input" or "Output" is displayed. For information on specifying special function modules, please see Sec. 12.1.3.

Display the monitor screen for the specified module.

X MODULE				sys. conf.	END
	X	O			
00	○	○	20	○	○
01	●	○	21	○	○
02	○	○	22	○	○
03	○	○	23	○	○
04	○	○	24	○	○
05	○	○	25	○	○
06	○	○	26	○	○
07	○	○	27	○	○
08	○	○	28	○	○
09	○	○	29	○	○
0A	○	○	2A	○	○
0B	○	○	2B	○	○
0C	○	○	2C	○	○
0D	○	○	2D	○	○
0E	○	○	2E	○	○
0F	○	○	2F	○	○

- (2) For information on confirming the displayed contents and subsequent operation, please see Sec. 13.2.

\* Tests cannot be conducted on input or output modules.

To Sec. 13.2



13.2 Monitor screen configuration and key functions

This section describes the configuration of monitor screens displayed by specifying the input module on the system configuration screen, and explains the functions of the keys displayed on the screen.

(1) Display (for an input module)

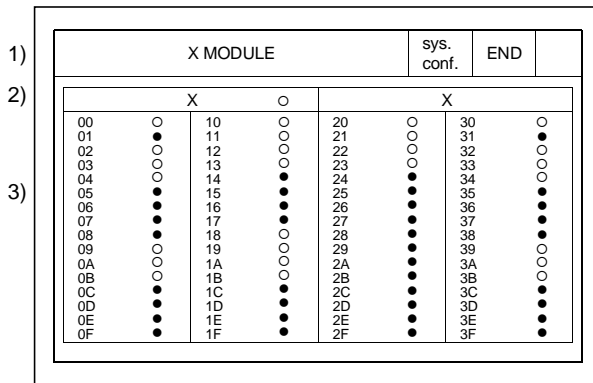

- 4) Displays the statuses of input and output signals after being read out from the corresponding module. (OS executes it automatically.)
- Statuses for up to 64 can be displayed.  
 Signal statuses:  
 ● : ON  
 ○ : OFF

1)	Displays the type of the object module (input or output module).
2)	Displays the name of the signal being monitored (X or Y).
3)	Displays the number and status of the input or output signal.
4)	Displays keys that are used with the operation of the monitor screen shown in (2) (Touch input).

(2) Key functions

The chart below shows the functions of the keys that are used with the Monitor Screen operation.

Key	Function
END	Monitoring ends; and display returns to the screen where the special module monitor function was begun.
sys. conf.	The current monitoring ends; and returns to the system configuration screen.

## Chapter14 Error display and handling with special module monitoring

The following chart shows the error messages that may be displayed when operating the special module monitor and the method of handling them.

Error message	Description	Method of Handling
Can not Communication	Communication could not be established with the PLC CPU.	(1) To try the operation again, touch "Retry". When the operation is retried, the error message disappears and monitoring resumes automatically, so no action is required. If monitoring is not resumed for a long period of time, however, check the following: 1) Connections between the PLC CPU and the GOT (disconnected or cut cables). 2) Has an error occurred in the PLC CPU? Etc.



Chapter15 Operating the network monitor function

This chapter describes how to operate the network monitor function.

15.1 Steps in getting started with the network monitor function

The following flowchart outlines how to transmit and install an operating system (OS) for the network monitor function in the GOT internal memory using the Personal computer.

For further information on screen displays and key operations, see the online help of the drawing software.

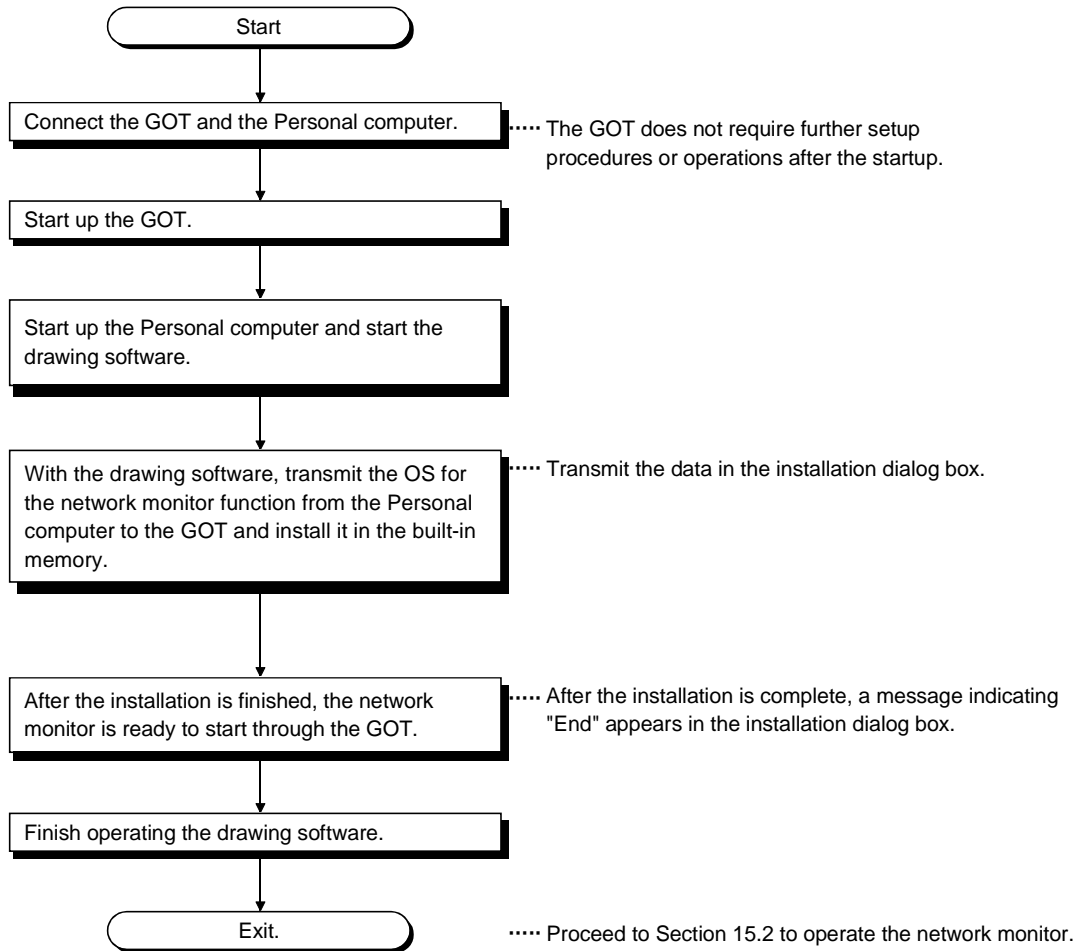

## 15.2 Steps in starting the network monitor function from the user-created monitor screen

The following flowchart outlines how to start the network monitor function after the operating system (OS) for the network monitor has been installed in the GOT built-in internal memory.



\*1 Touch the key assigned to the network monitor function (set in the touch switch expanded function of the drawing software). In the Utility Menu screen, touch **NET.MON.** to start the network monitor function.

Chapter16 Switching the network monitor screens

The following flowchart outlines the steps involved in switching the network monitor screens.

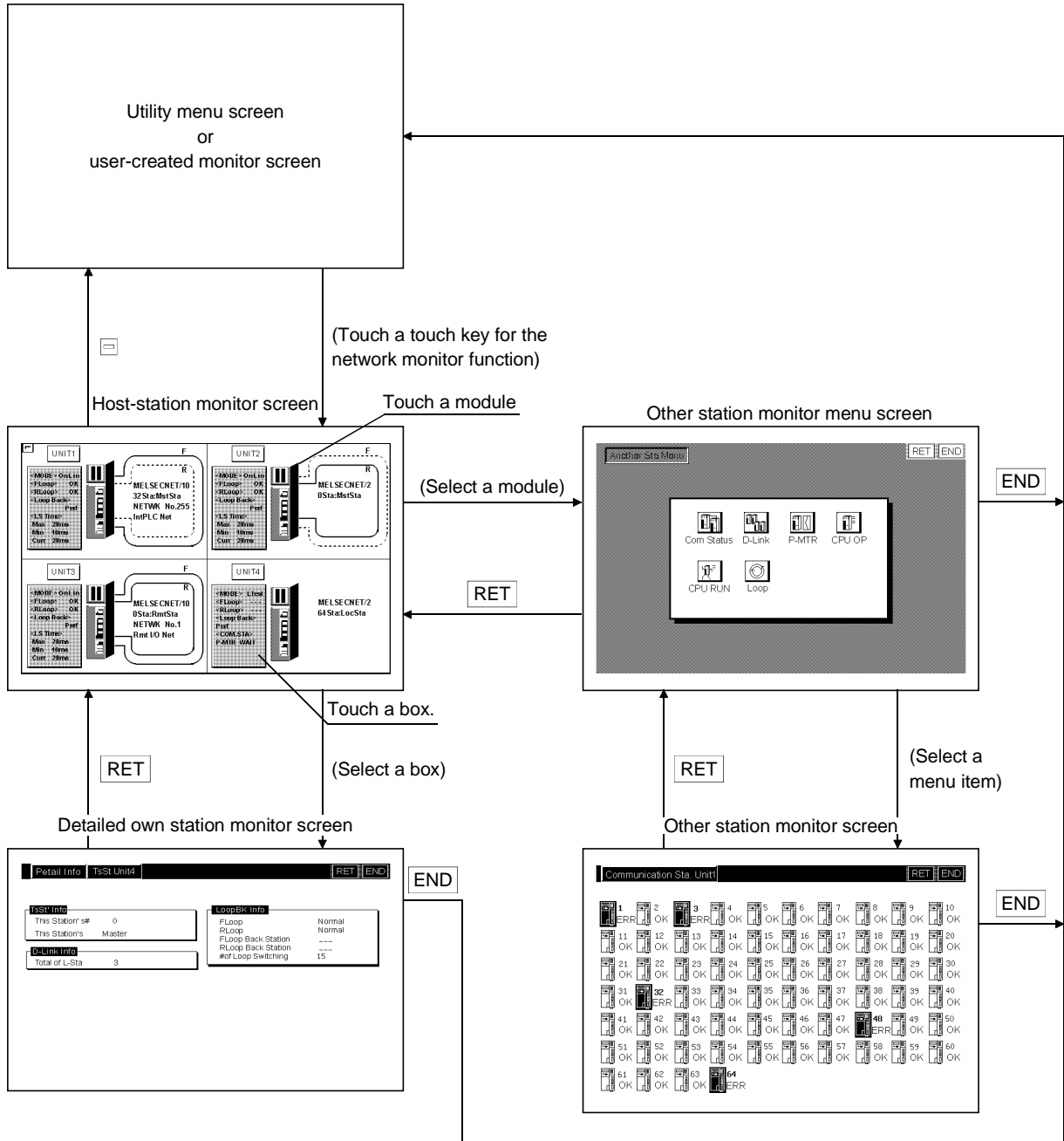



Chapter17 Using the network monitor screens

This chapter describes how to use various monitor screens when you execute the network monitor function.

17.1 Own station monitor

This section describes the structure of the monitor screen and the common operations used when executing the own station monitor.

17.1.1 Display contents and keys functions: own station monitor

This section describes the own station monitor screen and the function of on-screen keys, all of which are displayed and used when executing the network monitor function.

(1) Display contents

When the A985/97*/960GOT is used	When the A95*GOT is used
	<p>The display details are the same as the ones on the A985/97*/960GOT.</p> <p>Touch  button to change the display.</p> <p>(Display example)</p>



No.	Contents of Display
1)	<p>(1) This shows the action mode of the own station: On-line, Off-line, loop test.</p> <p>(2) This shows the status of the F-loop (primary loop): OK, NG.</p> <p>(3) This shows the status of the R-loop (secondary loop): OK, NG.</p> <p>(4) This shows whether the loopback was executed or not: Executed, Not executed.</p> <p>(5) This shows link scan time required for the control station and the ordinary station, for the remote master station and the remote I/O station, and for the mater station and all the sub-stations.</p> <p>(a) Maximum (the maximum value of link scan time)</p> <p>(b) Minimum (the minimum value of link scan time)</p> <p>(c) Current (the current value of link scan time)</p>
2)	<p>This shows the network category, network number, and station number.</p>
3)	<p>This shows the loop status of a network system as follows: (Primary loop: F, Secondary loop: R)</p> <p>(a) Primary loop : OK      (b) Primary loop : OK      (c) Primary loop : NG                      Secondary loop : OK      Secondary loop : NG      Secondary loop : OK</p> <p>(d) Executing loopback      (e) Primary loop : NG      (f) MELSECNET/10      (g) MELSECNET/10                      loopback      Secondary loop : NG      coaxial bus (OK)      coaxial bus (NG)</p>

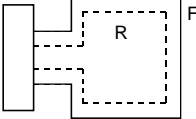
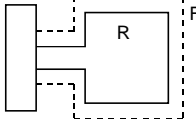
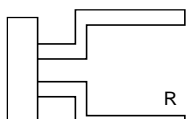
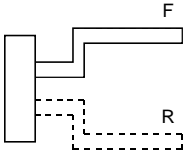
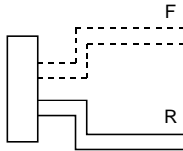
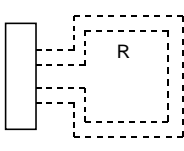

No.	Contents of Display
3)	<p>The following loop status in the data link system is displayed. (Primary loop: F, Sub-loop: R)</p> <p>(a) Data is linked in the Primary loop.      (b) Data is linked in the sub-loop.      (c) Loop-back is performed in the Primary/sub loop direction.</p>    <p>(d) Loop-back is performed in the Primary loop direction only.      (e) Loop-back is performed in the sub-loop direction only.      (f) Data link is not available.</p>   

(2) Key functions

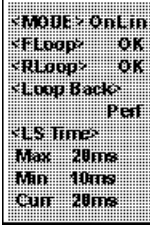
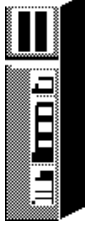
This section describes the function of keys to be used on the own station monitor screen.

Key	Function
	Exits the own station monitor screen and returns to the previous monitor screen where the network monitor function was executed.
	Switches to the detailed monitor screen that corresponds to the module displayed on the current monitor screen. This key is effective for each screen.
	Switches to the other station monitor menu that corresponds to the network displayed on the current monitor screen. This key is effective for each screen.
	Changes the details on the window. (only for A95*GOT)

17.2 Detailed own station monitor

This section describes the structure of the monitor screen and the common operations used when executing the detailed own station monitor.

17.2.1 Display contents and keys functions: acting as a MELSECNET/B or MELSECNET (II) master station

This section describes the detailed own station monitor screen and the function of on-screen keys, all of which are displayed and used when the own station acts as the master station on the MELSECNET/B or MELSECNET (II).

(1) Display contents

When the A985/97*/960GOT is used	When the A95*GOT is used
	<p>The display details are the same as the ones on the A985/97*/960GOT.</p> <p>Touch  button to change the display.</p> <p>(Display example)</p>

No.	Section	Contents of Display
1)	TsSt's Info	<ul style="list-style-type: none"> <li>• This Station's # Indicates the station number of the own station.</li> <li>• This Station's: Indicates the category of the own station.</li> </ul>
2)	D-Link Info	<ul style="list-style-type: none"> <li>• Total of L-Sta: Indicates the maximum number of the stations to be linked. The maximum number is defined by common parameters.</li> </ul>
3)	LoopBK Info	<ul style="list-style-type: none"> <li>• FLoop: Shows the status of the primary loop lines of the own station. (Normal/NG)</li> <li>• RLoop: Shows the status of the secondary loop lines of the own station. (Normal/NG)</li> <li>• Floop Back Station: Indicates the station number of a station that executes the loopback along the primary loop.</li> <li>• Rloop Back Station: Indicates the station number of a station that executes the loopback along the secondary loop.</li> <li>• # of Loop Switching: Indicates the cumulative number of times for which loops have been switched.</li> </ul>

(2) Key functions

The table below shows the function of keys that are used on the detailed own station monitor screen.

Key	Function
[RET]	Returns to the own station monitor screen.
[END]	Exits the detailed own station monitor screen and returns to the previous monitor screen where the network monitor function was executed.
	Changes the details on the window. (only for A95*GOT)

17.2.2 Display contents and keys functions: acting as a MELSECNET/B or MELSECNET (II) local station

This section describes the detailed own station monitor screen and the function of on-screen keys, all of which are displayed and used when the own station acts as the local station on the MELSECNET/B or MELSECNET (II).

(1) Display contents

When the A985/97*/960GOT is used	When the A95*GOT is used
	<p>The display details are the same as the ones on the A985/97*/960GOT.</p> <p>Touch  button to change the display.</p> <p>(Display example)</p>

No.	Section	Contents of Display
1)	TsSt' Info	<ul style="list-style-type: none"> <li>This Station's # Indicates the station number of the own station.</li> <li>This Station's: Indicates the category of the own station.</li> </ul>
2)	D-Link Info	<ul style="list-style-type: none"> <li>Total of L-Sta: Indicates the maximum number of the stations to be linked. The maximum number is defined by common parameters.</li> </ul>
3)	Com Status	<ul style="list-style-type: none"> <li>Com Status: Displays the communications status of the own station. (Parameter wait, Cyclic comm, NG)</li> </ul>
4)	BWY From Master	<ul style="list-style-type: none"> <li>This shows the status of receiving Device BWY from the master station. OK: Data is being received by cyclic receiving. NG: The own station cannot receive data because of column reading.</li> </ul>
5)	BW From Hostmaster	<ul style="list-style-type: none"> <li>This shows the status of receiving Device BW from the master station of a dual-layer system. OK: Data is being received by cyclic receiving. NG: The own station cannot receive data due to column reading.</li> </ul>
6)	LoopBK Info	<ul style="list-style-type: none"> <li>FLoop: Shows the status of the primary loop lines of the own station. (Normal/NG)</li> <li>RLoop: Shows the status of the secondary loop lines of the own station. (Normal/NG)</li> </ul>

(2) Key functions

The table below shows the functions of keys that are used on the detailed own station monitor screen.

Key	Function
	Returns to the own station monitor screen.
	Exits the detailed own station monitor screen and returns to the previous monitor screen where the network monitor function was executed.
	Changes the details on the window. (only for A95*GOT)

17.2.3 Display contents and keys functions: acting as a MELSECNET/10 Control station/ordinary Station

This section describes the contents of the detailed own station monitor screen and the function of on-screen keys. All these are displayed and used when the own station acts as the control station/ordinary station on the MELSECNET/10.

(1) Display contents

When the A985/97*/960GOT is used	When the A95*GOT is used
	<p>The display details are the same as the ones on the A985/97*/960GOT.</p> <p>Touch  button to change the display.</p> <p>(Display example)</p>

No.	Section	Contents of Display
1)	TsSt' Info	<ul style="list-style-type: none"> <li>• This Station's # : Indicates the station number of the own station.</li> <li>• Network # : Indicates the network number.</li> <li>• Group # : Indicates the group number.</li> </ul>
2)	Ctrl St Info	<ul style="list-style-type: none"> <li>• Spc Ctrl Sta: Indicates the station number of a station that is specified as a control station.</li> <li>• Curr Ctrl Sta: Indicates the station number of a station that is currently acting as the control station.</li> <li>• Com Info: Indicates whether the own station is communicating with the control station or the sub control station.</li> <li>• SubCtrl Sta Com: Indicates the availability of a sub control station. (Available/None)</li> <li>• Rmt I/O Mst Sta: Indicates the station number of a remote I/O master station in Block 1 or Block 2. If the master station is not available, this indicates "None" instead.</li> </ul>



No.	Section	Contents of Display
3)	D-Link Info	<ul style="list-style-type: none"> <li>• Total of L-Sta: Indicates the maximum number of the stations to be linked. The maximum number is defined by common parameters.</li> <li>• Largest Nrm Sta: Indicates the station number of the largest station that is connected in a normal condition.</li> <li>• Largest DL-Sta: Indicates the station number of the largest station that is data-linked.</li> <li>• Com Status: Show the current communications status of the own station. (D- Link in prog, D- Link Stop (A), D- Link Stop (H), B- Pass excut, Disconnection, Testing, Reset. in prgr.)</li> <li>• Causes of Ssp: Indicates the causes why the communications were interrupted. This indicates "OK" if communications is in a normal condition. (Normal, Offline, Offline Test, Others (error codes))</li> <li>• Causes of Stop: Indicates the causes why the data link was stopped. This indicate "OK" if the data link is in a normal condition. (No common para, Host Para error, Instructed by Other Station (n station), Essential Parameter Not Matched, Instructed by Host Station, Improper I/O Allocation, Instructed by All Stations (n stations), Others (error codes))</li> </ul>
4)	Constant LS	<ul style="list-style-type: none"> <li>• Constant LS: Indicates the predetermined time of constant link scans.</li> </ul>
5)	LoopBK Info	<ul style="list-style-type: none"> <li>• FLoop: Shows the status of the primary loop lines of the own station. (Normal/LoopBK Trans/D-Link Impo)</li> <li>• RLoop: Shows the status of the secondary loop lines of the own station. (Normal/LoopBK Trans/D-Link Impo)</li> <li>• FLoop Back Station: Indicates the station number of a station that executes the loopback along the primary loop.</li> <li>• RLoop Back Station: Indicates the station number of a station that executes the loopback along the secondary loop.</li> <li>• # of Loop Switching: Indicates the cumulative number of times for which loops have been switched. * "---" is displayed when coaxial bus connections are established.</li> </ul>

No.	Section	Contents of Display
6)	TsSt' Sta	<ul style="list-style-type: none"> <li>• Parameter Setting: Common Param, Common + Spec if, Default Param, Default + Specif</li> <li>• Reserved Sta: Indicates the availability of a reserved station. (Have/None)</li> <li>• Communication Mode: Indicates either of "Normal mode" or "Constant LS."</li> <li>• Transmission Mode: Indicates either of "Normal Trans" or "Multipl Trans." *</li> <li>• Transmission Stat: Indicates either of "Normal Trans" or "Multipl Trans." *</li> </ul>

\* "---" is displayed when coaxial bus connections are established.

(2) Key functions

The table below shows the function of keys that are used on the detailed own station monitor screen.

Key	Function
	Returns to the own station monitor screen.
	Exits the detailed own station monitor screen and returns to the previous monitor screen where the network monitor function was executed.
	Changes the details on the window. (only for A95*GOT)

17.2.4 Display contents and keys functions: acting as a MELSECNET/10 remote master station

This section describes the detailed own station monitor screen and the function of on-screen keys, all of which are displayed and used when the own station acts as the remote master station on the MELSECNET/10.

(1) Display contents

When the A985/97*/960GOT is used	When the A95*GOT is used
	<p>The display details are the same as the ones on the A985/97*/960GOT.</p> <p>Touch  button to change the display.</p> <p>(Display example)</p>

No.	Section	Contents of Display
1)	TsSt' Info	<ul style="list-style-type: none"> <li>•This Stations # : Indicates the station number of the own station.</li> <li>• Network # : Indicates the network number.</li> <li>• Group # : Not displayed.</li> </ul>
2)	Ctrl St Info	<ul style="list-style-type: none"> <li>• Spc Ctrl Sta: Not displayed</li> <li>• Curr Ctrl Sta: Not displayed</li> <li>• Com Info: Not displayed</li> <li>• SubCtrl-Sta Com: Not displayed</li> </ul>

No.	Section	Contents of Display
3)	D-Link Info	<ul style="list-style-type: none"> <li>• Total of L-Sta: Indicates the maximum number of the stations to be linked. The maximum number is defined by common parameters.</li> <li>• Largest Nrm Sta: Indicates the station number of the largest station that is connected in a normal condition.</li> <li>• Largest DL-Sta: Indicates the station number of the largest station that is data-linked.</li> <li>• Com Status: Show the current communications status of the own station. (D-Link in prog, D-Link Stop (A), D-Link Stop (H), B-Pass excut, Disconnection, Testing, Reset. in prgr.)</li> <li>• Causes of Ssp: Indicates the reason why the communications were interrupted. This indicates "OK" if communications is in a normal condition. (Normal, Offline, Offline Test, Others (error codes))</li> <li>• Causes of Stop: Indicates the causes why the data link was stopped. This indicates "OK" if the data link is in a normal condition. (No common para, Host Para error, Instructed by Other Station (n station), Essential Parameter Not Matched, Instructed by Host Station, Improper I/O Allocation, Instructed by All Stations (n stations), Others (error codes))</li> </ul>
4)	Constant LS	<ul style="list-style-type: none"> <li>• Constant LS: Indicates the predetermined time of constant link scans.</li> </ul>
5)	LoopBK Info	<ul style="list-style-type: none"> <li>• FLoop: Shows the status of the primary loop lines of the own station. (Normal/LoopBK Trans/D-Link Impo)</li> <li>• RLoop: Shows the status of the secondary loop lines of the own station. (Normal/LoopBK Trans/D-Link Impo)</li> <li>• FLoop Back Station: Indicates the station number of a station that executes the loopback along the primary loop.</li> <li>• RLoop Back Station: Indicates the station number of a station that executes the loopback along the secondary loop.</li> <li>• # of Loop Switching: Indicates the cumulative number of times for which loops have been switched. * "---" is displayed when coaxial bus connections are established.</li> </ul>





No.	Section	Contents of Display
6)	TsSt' Sta	<ul style="list-style-type: none"> <li>• Parameter Setting: Not displayed.</li> <li>• Reserved Sta: Indicates the availability of a reserved station. (Have/None)</li> <li>• Communication Mode: Indicates either of "Normal mode" or "Constant LS."</li> <li>• Transmission Mode: Indicates either of " Normal Trans " or " Multipl trans." *</li> <li>• Transmission Stat: Indicates either of " Normal Trans " or Multipl trans." *</li> </ul>

\* "---" is displayed when coaxial bus connections are established.

(2) Key functions

The table below shows the function of keys that are used on the detailed own station monitor screen.

Key	Function
	Returns to the own station monitor screen.
	Exits the detailed own station monitor screen and returns to the previous monitor screen where the network monitor function was executed.
	Changes the details on the window. (only for A95*GOT)

17.3 Other station monitor

This section describes the structure of the monitor screen and the common operations used when executing the other station monitor.

17.3.1 Display contents and keys functions: other station monitor menu

This section describes the other station monitor menu screen and the function of on-screen keys. The menu screen for the other station monitor is displayed by touching a module number displayed on the own station monitor screen. The menu screen provides many options for the other station monitor.

(1) Display contents

When the A985/97*/960GOT is used	When the A95*GOT is used
	<p>The display details are the same as the ones on the A985/97*/960GOT.</p> <p>(Display example)</p>

No.	Touch Key	Contents of Display
1)	Communications Status	Switches to a monitor screen that shows the communications status of other stations. *
2)	Data Link	Switches to a monitor screen that shows the data link status of other stations. *
3)	Parameters	Switches to a monitor screen that shows the parameter status of other stations. *
4)	CPU Action	Switches to a monitor screen that shows the CPU action status of other stations.
5)	CPU RUN	Switches to a monitor screen that shows the CPU RUN status of other stations.
6)	Loop	Switches to a monitor screen that shows the loop status of other stations.

\* This is not selectable when connected to a MELSECNET/B or MELSECNET (II) local station.

(2) Key Functions

The table below shows the function of keys that are used on the other station monitor screen.

Key	Function
	Switches to the other station monitor screen.
RET	Returns to the own station monitor screen.
END	Exits the other station monitor screen and returns to the previous monitor screen where the network monitor function was executed.

17.3.2 Display contents and keys functions: other station communication status monitor

This section describes the other station communications status monitor screen and the function of on-screen keys.

(1) Display contents

When the A985/97*/960GOT is used	When the A95*GOT is used
	<p>The display details are the same as the ones on the A985/97*/960GOT.</p> <p>(Display example)</p>

No.	Contents of Display
1)	Station numbers are shown up to the maximum number of linked stations.
2)	Any station in an abnormal condition is highlighted on-screen.
3)	Any station specified as a reserved station is treated as a station that stays in a normal condition.

(2) Key Functions

The table below shows the function of keys that are used on the other station communications status monitor screen.

Key	Function
RET	Returns to the own station monitor screen.
END	Exits the other station communications status monitor screen and returns to the previous monitor screen where the network monitor function was executed.

17.3.3 Display contents and keys functions: other station data link status monitor

This section describes the other station data link status monitor screen and the function of on-screen keys.

(1) Display contents

When the A985/97*/960GOT is used	When the A95*GOT is used
	<p>The display details are the same as the ones on the A985/97*/960GOT.</p> <p>(Display example)</p>

No.	Contents of Display
1)	Station numbers are shown up to the maximum number of linked stations.
2)	Any station that is not data-linked is highlighted on-screen.
3)	Any station specified as a reserved station is treated as a station that stays in a normal condition.

(2) Key Functions

The table below shows the function of keys that are used on the other station data link status monitor screen.

Key	Function
RET	Returns to the own station monitor screen.
END	Exits the other station data link status monitor screen and returns to the previous monitor screen where the network monitor function was executed.

17.3.4 Display contents and keys functions: other station parameter status monitor

This section describes the other station parameter status monitor screen and the function of on-screen keys.

(1) Display contents

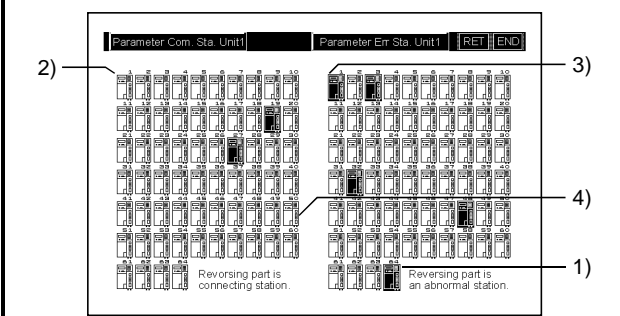
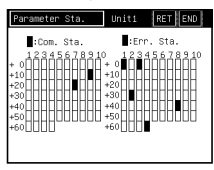
When the A985/97*/960GOT is used	When the A95*GOT is used
	<p>The display details are the same as the ones on the A985/97*/960GOT.</p> <p>(Display example)</p> 

No.	Contents of Display
1)	Station numbers are shown up to the maximum number of linked stations.
2)	Any station whose parameters are monitored is highlighted on-screen. *
3)	Any station that stays in an abnormal condition is highlighted on-screen.
4)	A station specified as a reserved station is treated as a station that stays in a normal condition.

\* Not highlighted when connected to a MELSECNET/B or MELSECNET (II) master station.

(2) Key Functions

The table below shows the function of keys that are used on the other station parameter status monitor screen.

Key	Function
RET	Returns to the own station monitor screen.
END	Exits the other station parameter status monitor screen and returns to the previous monitor screen where the network monitor function was executed.

17.3.5 Display contents and keys functions: other station CPU action status monitor

This section describes the other station CPU action status monitor screen and the function of on-screen keys.

This option is not selectable when connecting to a remote I/O network system.

(1) Display contents

When the A985/97*/960GOT is used	When the A95*GOT is used
	<p>The display details are the same as the ones on the A985/97*/960GOT.</p> <p>(Display example)</p>

No.	Contents of Display
1)	Station numbers are shown up to the maximum number of linked stations.
2)	Any station that stays in an abnormal condition or out of action is highlighted on-screen.
3)	A station specified as a reserved station is treated as a station that stays in a normal condition.

(2) Key Functions

The table below shows the function of keys that are used on the other station CPU action status monitor screen.

Key	Function
RET	Returns to the own station monitor screen.
END	Exits the other station CPU action status monitor screen and returns to the previous monitor screen where the network monitor function was executed.



17.3.7 Display contents and keys functions: other station loop status monitor

This section describes the other station loop status monitor screen and the function of on-screen keys.

\* This option is not selectable when connecting to a MELSECNET/B or MELSECNET (II) local station or establishing MELSECNET/10 coaxial bus connections.

(1) Display contents

When the A985/97*/960GOT is used	When the A95*GOT is used
	<p>The display details are the same as the ones on the A985/97*/960GOT.</p> <p>(Display example)</p>

No.	Contents of Display
1)	The F-loop (primary loop) status and the R-loop (secondary loop status) are displayed.
2)	Station numbers are shown up to the maximum number of linked stations.
3)	Any station that stays in an abnormal condition is highlighted on-screen.
4)	A station specified as a reserved station is treated as a station that stays in a normal condition.

(2) Key Functions

The table below shows the function of keys that are used on the other station loop status monitor screen.

Key	Function
RET	Returns to the own station monitor screen.
END	Exits the other station loop status monitor screen and returns to the previous monitor screen where the network monitor function was executed.





## Chapter18 Error Displays and Countermeasures when Monitoring Networks

The following chart shows the error messages that are displayed during the network monitor operation and how to handle them.

Error message	Contents of error	Action to take
Can not Communication	Communication could not established with the PLC CPU.	<ul style="list-style-type: none"><li>• Check the connections between the PLC CPU and the GOT for disconnected connectors and cables.</li><li>• Check if an error has occurred in the PLC CPU.</li></ul>
Key Word error	The PLC CPU to be connected is keyword-protected by the QnA.	<ul style="list-style-type: none"><li>• Release the keyword.</li></ul>



Chapter19. Operation Procedures for the List editor function

This section describes the operation procedures for use of list editor function.

19.1 Operation procedures before starting the list edit

Procedures for transferring the operating system (OS) for the list editor function from the personal computer to the GOT and for installing the system into the memory.

For details, refer to the Help of the drawing software. Detailed information including displays and key operations is provided.

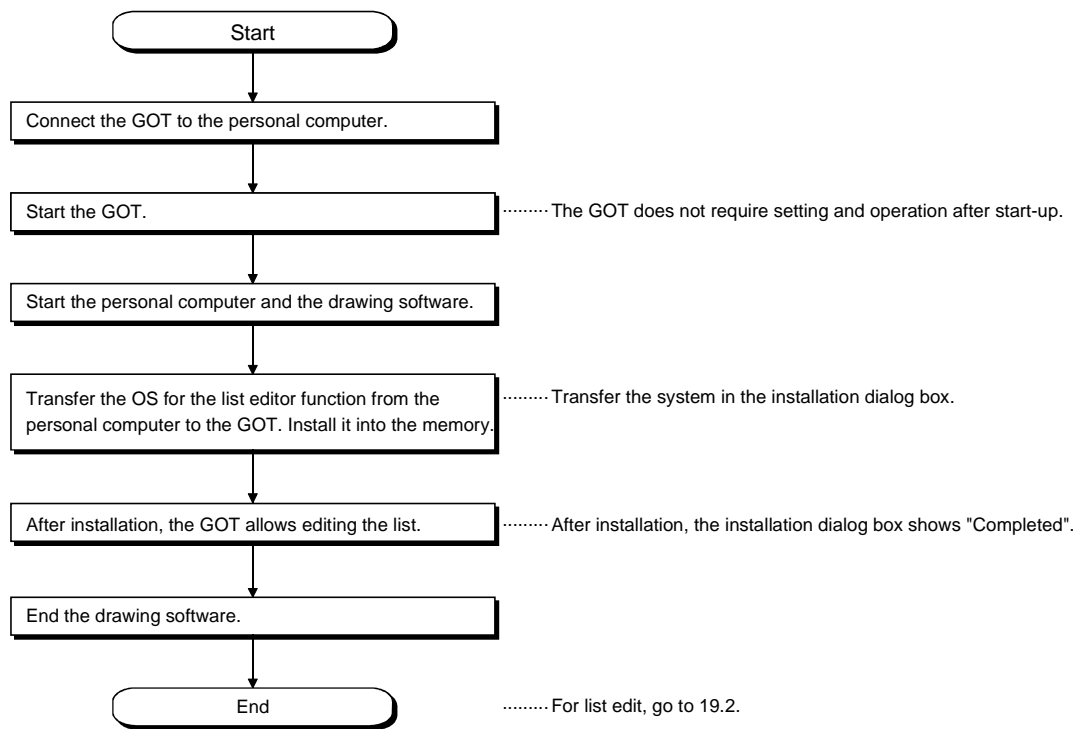

19.2 Operation procedures from user-created monitor screen display to starting list editing

This section explains how you should operate the GOT to access the list editor function after having installed the list editor function operating system (OS) to the GOT internal memory.

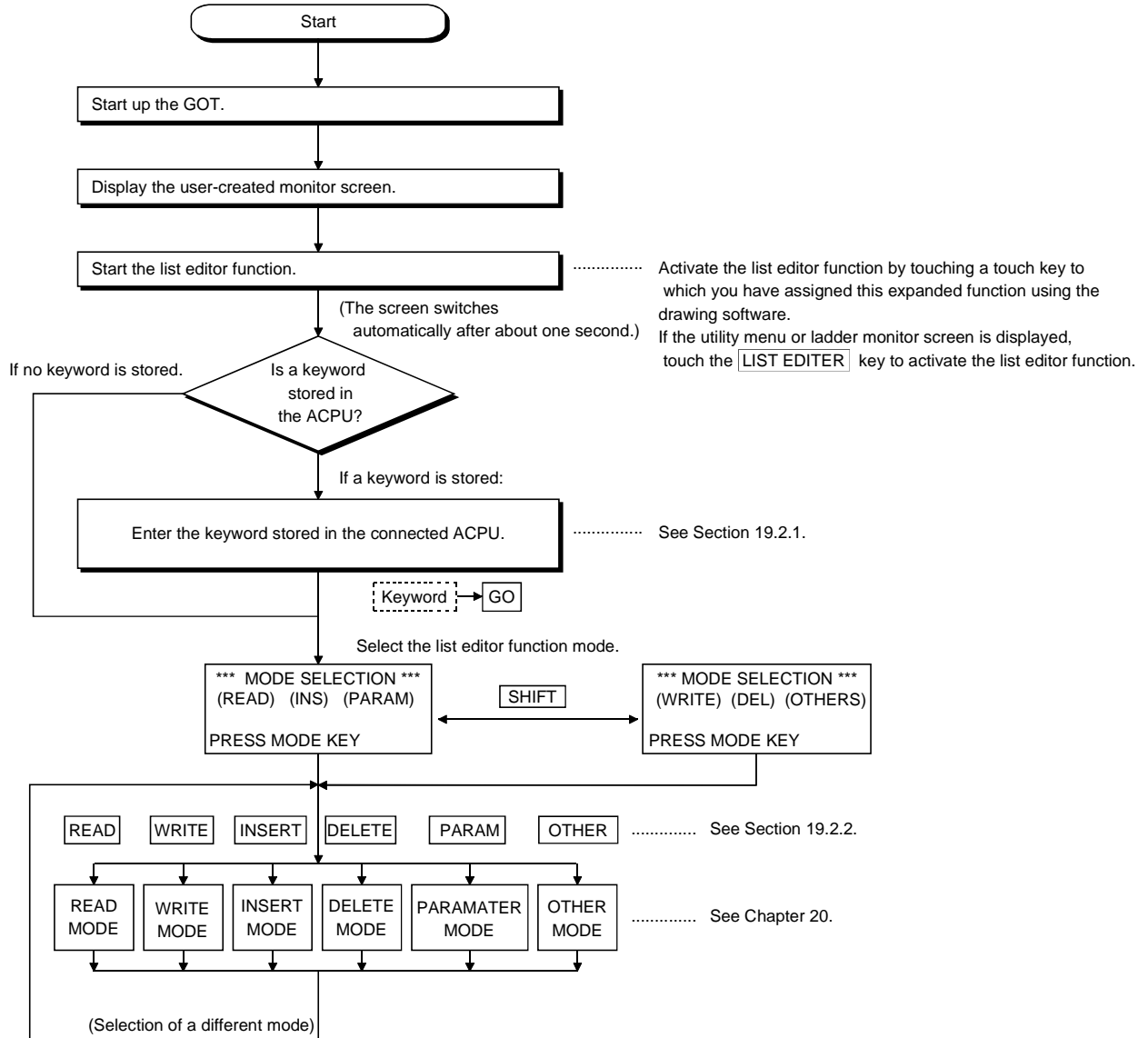

19.2.1 Operation of keyword input

If a keyword is registered in the ACPU when the connected ACPU or the ACPU PLC No. corresponding to the operation is changed, the GOT requests for input of the registered keyword. Input the keyword registered in the ACPU and press the **GO** key. If a keyword is not registered in the ACPU, this operation is not required. (The operation automatically changes to Selection of Function and Mode in 19.2.2.)

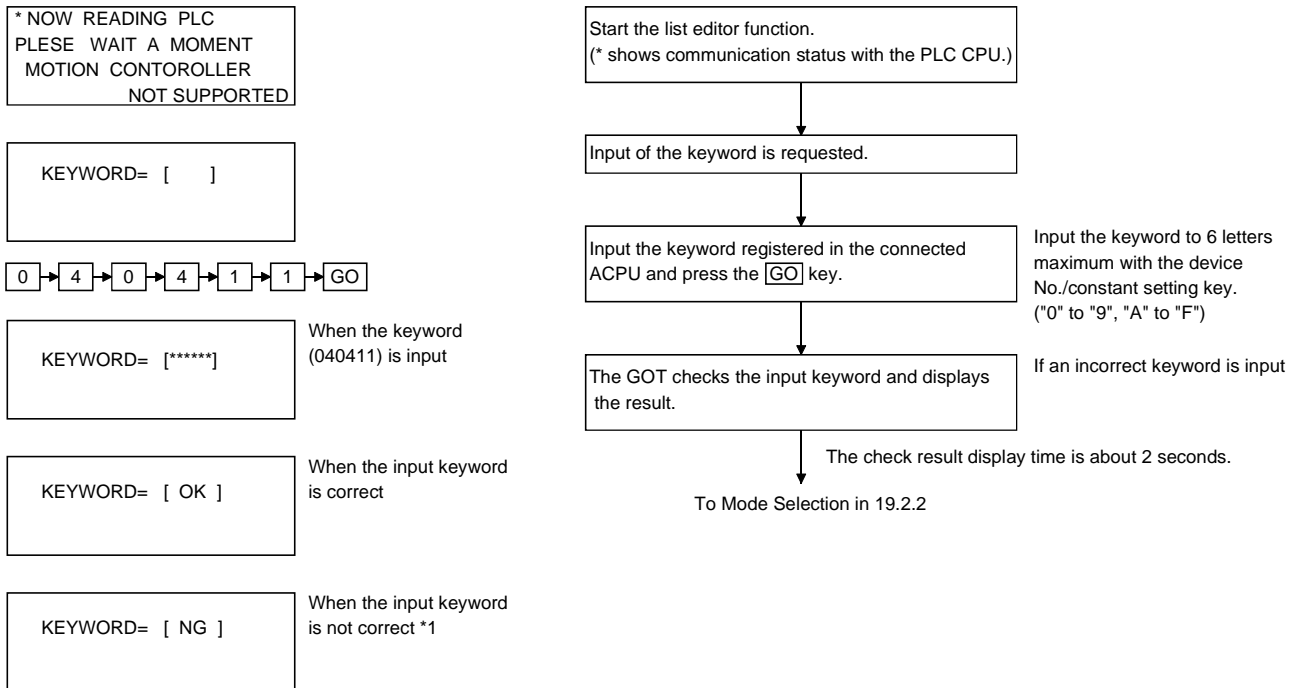

\*1 When the input keyword does not match with the registered keyword, only the following operations in Chapter 20 can be allowed.

- Other modes
- Error step reading
  - Buffer memory overall monitor
  - Time monitor
  - PLC No. setting
  - Main/sub switching

POINTS
<ul style="list-style-type: none"> <li>For operations not shown in other modes, clear (delete) the registered keyword with the "PLC memory all clear" in the following page if you do not remember the keyword registered in the ACPU. When "PLC memory all clear" is performed, the user data including sequence program is also cleared.</li> <li>The keyword registered in the ACPU can be changed or a new keyword can be registered as shown in Chapter 20.</li> </ul>

# 19. OPERATION PROCEDURES FOR THE LIST EDITOR FUNCTION MELSEC GOT

When input of a keyword is requested, all parameters and sequence programs can be cleared together with the keyword registered in the ACPU using the operation below.

(Step 1) Display the keyword input request.

KEYWORD= [            ]

(Step 2) Stop operation of ACPU

(Step 3) Operation of PC memory all clear

Input "ALLCLR" and press the GO key.

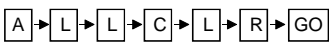

(Step 4) Display of PC memory all clear process

When the GOT starts clearing the process, the display in the left appears. "\*" column and the total number of bytes change sequentially.

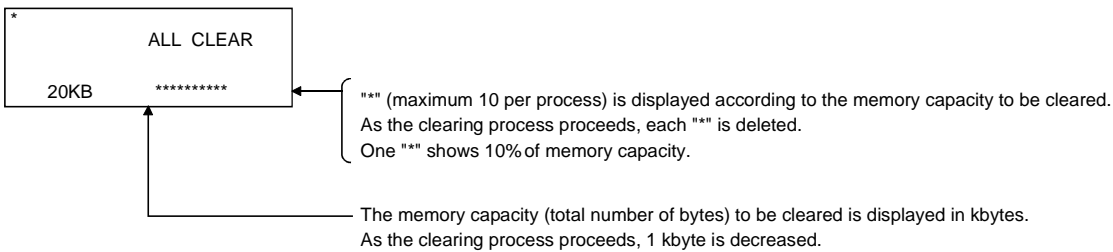

(Step 5) Completion of PC memory all clear process

When the GOT completes the clearing process, the screen in the left appears.

(status before the mode selection)

\*\* MODE SELECTION \*\*  
(READ) (INS) (PARAM)

PRESS MODE KEY

(Step 6) Select the mode as in 19.2.2 and start the following operation.

19.2.2 Selection and operation of mode

After the keyword input, select the mode in the list editor function for operations in Chapter 20.

(1) Selection and change of mode with mode key

Select the mode with the mode key (Refer to 3.5.5.) so that operation corresponding to the mode in Chapter 20 may be performed.

The mode can be freely changed when operations in Chapter 20 are performed.

Various operations can be continued while changing modes. \*1

<input type="checkbox"/> READ	-----	Read mode
<input type="checkbox"/> WRITE	-----	Write mode
<input type="checkbox"/> INSERT	-----	Insert mode
<input type="checkbox"/> DELETE	-----	Delete mode
<input type="checkbox"/> PARAM	-----	Parameter mode
<input type="checkbox"/> OTHER	-----	Other mode

\*1 Mode key input is always valid.

Input of the mode key clears the input data except for the step numbers. The display returns to the initial status of the mode selection.

(2) Operation in each mode

The mode selected in (1) allows for operation corresponding to the mode in Chapter 20. Operation procedures of each mode are described in Chapter 20.

Operate the GOT according to the description.

If an error message appears during operation, take action according to Chapter 21.





## Chapter 20. Operation of Editing Screen for Each List

This section describes the operation procedures of the list edit screen.

### 20.1 Basic operation of key input

After starting the list editor function, basic operations of key input are described.

#### 20.1.1 Switching of valid key (function indicated at the upper/lower part of the key)

When the list edit has started, whether the upper or the lower key available for two purposes is valid is displayed on the second line at the left end of the display.

The GOT controls and displays the valid key. A user may switch the valid key with the following keys.

\* :Upper character key is valid.  
 :Lower character key is valid.

\* The following keys can be input if the valid key is at the lower character.

(Input of  key is not required.)

- Comparison symbol key at the command input of comparison operation instruction.

, ,

- Minus key at the source data of command.

The valid key after setting each mode switches as follows:

Read mode, Write mode, Insert mode	: Upper character key (When the cursor position is at the setting value and the device step is in the Write mode, the "lower character" key is valid.)
Parameter mode and other modes	: Always lower character key
Help of each mode	: Always lower character key (When "Command Read" is selected from the Help in the Read mode, the upper character key is valid.)

When  key is input and the valid key is switched, the switched side is valid until the mode key and the control key are input.

For details of each key, refer to 3.5.4.

20.1.2 Command input procedures

Command input procedures can be classified as follows:

- 1) Input the command key to use the command on the key.
- 2) Input the alphanumeric keys corresponding to each character of command sequentially.
- 3) Select and input the command to be used from the Help function.

Command input procedures for 1) and 2) above are as follows.

For command input procedure 3) from the Help function, refer to 20.2.5.

**POINT**

When the command is input, the input details are displayed at the 4th line (the bottom line) on the display. In the following description, the input of **[SP]** key may be omitted when a blank space between the input command and the cursor position is automatically inserted. Refer to the example in each description.

(1) For command code only

1) When the command available on the keyboard is input

Command → **[GO]**

(Ex) When END is input

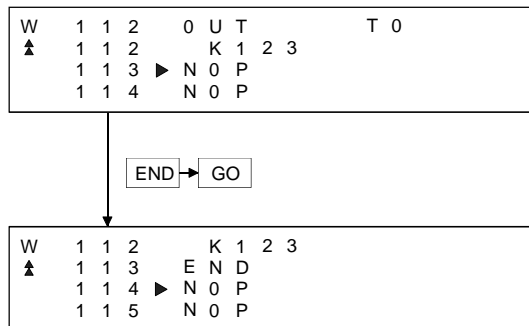

2) When the command not available on the keyboard is input

(Ex) When FOR K5 is input

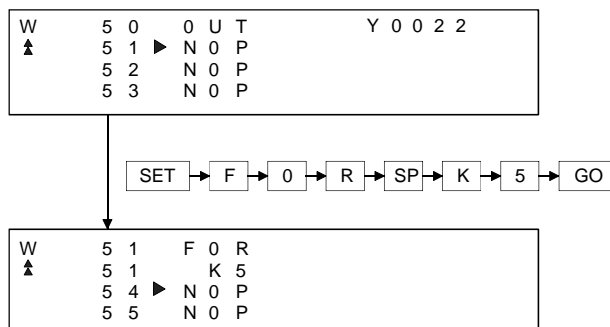

(2) For command code and device (1)

Command →  → DEVICE → DEVICE No. →

(Ex) When LD X0 is input

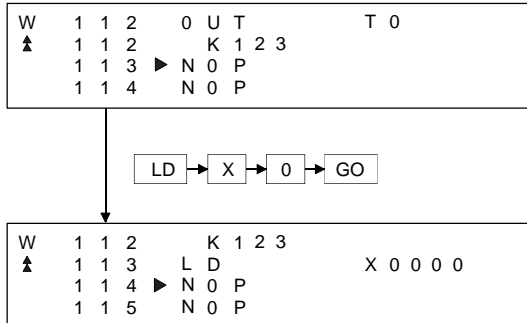

(3) For commands other than above

Input the  key between the command and the device, the source data, and the destination data.

(Ex 1) When FMOV K-2 DO K5 is input

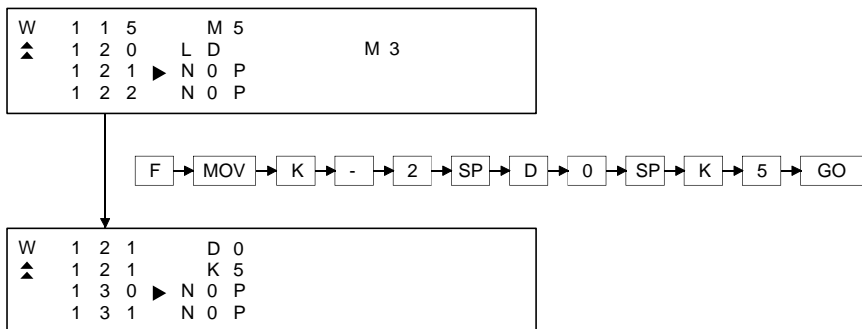

(Ex 2) When OUT T1 K10 is input

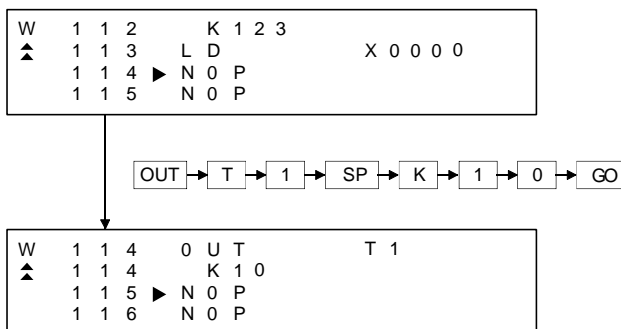

(Ex 3) When MC N3 M5 is input

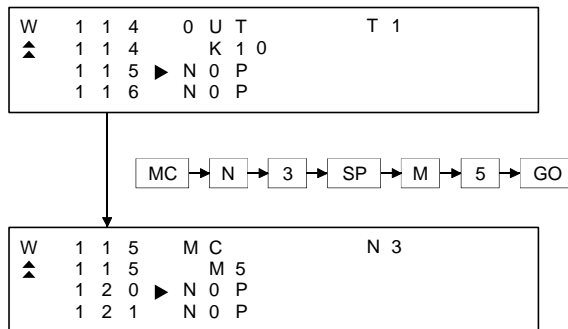

(Ex 4) When LD = K10 D10 is input

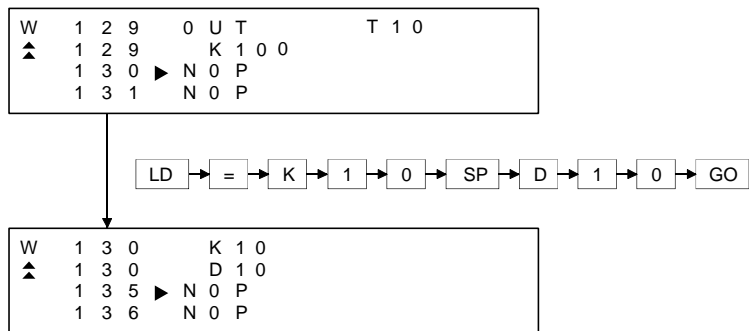

(Ex 5) When ANDD<=H7FFFF D20 is input

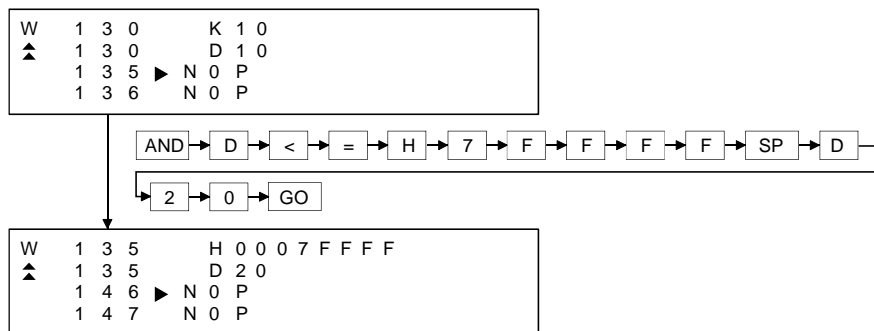

(4) Handling of devices M, L and S

Devices M, L and S in the Test, Monitor, Write and Insert modes change the display depending on the set parameters.

If LD L0 is input for the parameter setting of M0 to 999 and L1000 to L2047, the result is LD M0.

(5) For extension timer/extension counter of AnA and AnUCPU

When the extension timer (T256 to T2047) and the extension counter (C256 to C1023) are input as the first device of the command, input the first device and the device number.

(Ex) When OUT T256 D500 is input

W	9 9	0 U T	M 1 0
▲	1 0 0	L D	
	1 0 1	▶ N O P	
	1 0 2	N O P	

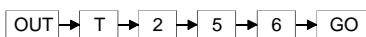

W	1 0 1	0 U T	T 2 5 6
▲	1 0 2	D 5 0 0	
	1 0 3	▶ N O P	
	1 0 4	N O P	

← The device (D500) for the T256 setting value on the parameter is automatically displayed.

<b>POINT</b>	
<p>When the extension timer and the extension counter are used, be sure to set the 257 points or more and the setting value device (D, W, R) on the parameter for both the timer and the counter.</p>	

## 20.1.3 Action if an incorrect key is input

- (1) Input the **CLEAR** key before the **GO** key. Then input the correct key.  
Input of the **CLEAR** key clears the command and the device number that have been input immediately. The display returns to the status (status before change in the Write mode) when the mode is selected.
- (2) When the **GO** key is input, repeat the intended operation.  
Command input procedures can be classified as follows:

**REMARK**

When the **CLEAR** key is input in the parameter mode, the GOT stops the process.  
To continue the operation, carry on the key input.

20.2 Basic operation of list edit

This section describes basic operations of list edit with simple operation examples.

20.2.1 Reading sequence program

The sequence program is read to check its content.

[Operation example]

1) <input type="button" value="READ"/>	<pre>R 7 D20 ^ 14 END 15▶NCP 16 NCP</pre>	Select the "Read" mode.
2) <input type="button" value="SET"/> → <input type="text" value="0"/> → <input type="button" value="GO"/>	<pre>R 0▶LD X0000 ^ 1 OR Y0010 2 ANI X0001 3 OUT Y0010</pre>	Read the 0th step.
3) <input type="button" value="GO"/>	<pre>R 3 OUT Y0010 ^ 4▶OUT T0 4 K10 5 LD T0</pre>	
↓		
Scroll the screen with the <input type="button" value="GO"/> key.		



20.2.2 Changing (overwriting) command

The following example shows the changing procedure of the sequence program.

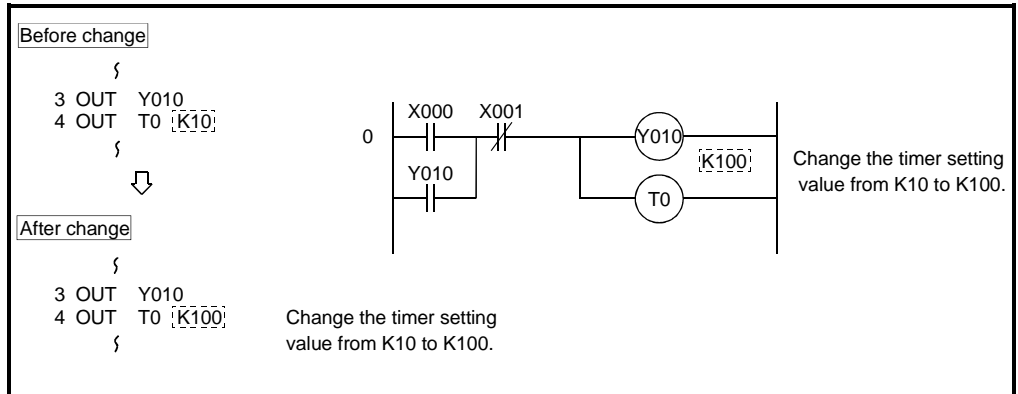

[Operation example]

<p>1) <b>SHIFT</b> → <b>WRITE</b></p>	<pre> W 7 K80 ^ 7▶ K5 7 D20 14 END     </pre>	<p>Select the "Write" mode.</p>
<p>2) <b>SET</b> → <b>4</b> → <b>GO</b></p>	<pre> W 3 OUT Y0010 ^ 4▶OUT T0 4 K10 5 LD T0     </pre>	<p>Read the 4th step that changes the setting value.</p>
<p>3) <b>↓</b> → <b>GO</b></p>	<pre> W 3 OUT Y0010 v 4 OUT T0 4▶ K10 K10     </pre>	<p>Move the cursor to setting value "K10" of T0.</p>
<p>4) <b>K</b> → <b>1</b> → <b>0</b> → <b>0</b> → <b>GO</b></p>	<pre> W 4 OUT T0 ^ 4 K100 5▶LD T0 6 ANI MD     </pre>	
<p>↓</p>		
<p>The setting value of timer T0 was changed from "K10" to "K100".</p>		

20.2.3 Adding (inserting) command

The following example shows the procedure of adding the command to the sequence program..

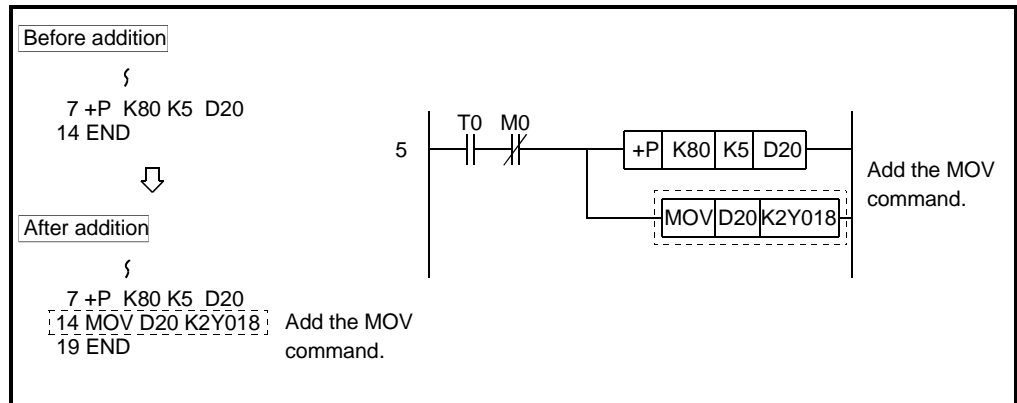

[Operation example]

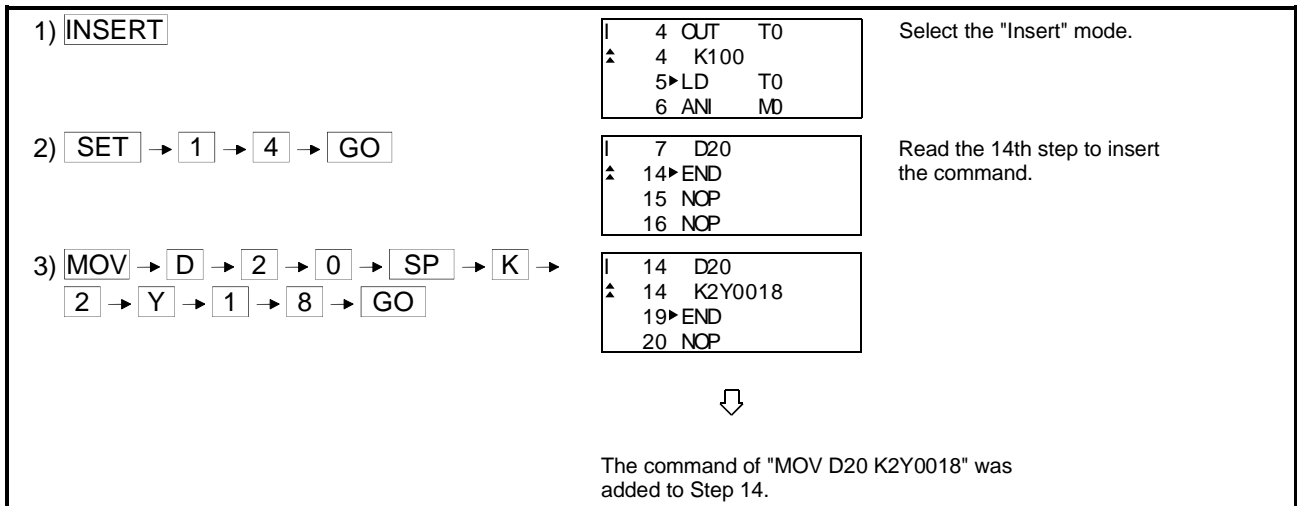

20.2.4 Deleting command

The following example shows the procedure of deleting the command from the sequence program.

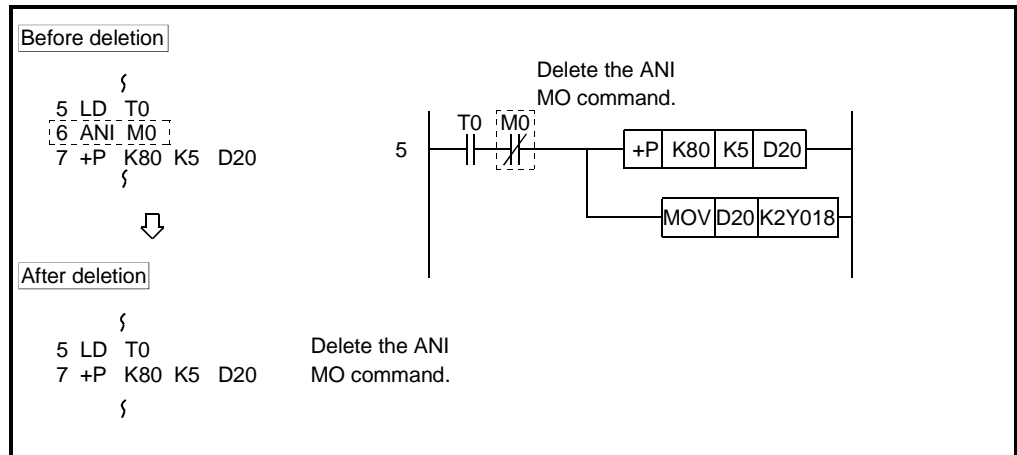

[Operation example]

1) <b>SHIFT</b> → <b>DELETE</b>	<pre> D 14 D20 ^ 14 K2Y0018 19▶END 20 NCP                 </pre>	Select the "Delete" mode.
2) <b>SET</b> → <b>6</b> → <b>GO</b>	<pre> D 5 LD T0 ^ 6▶ANI M0 7 +P 7 K80                 </pre>	Read the 6th step
3) <b>GO</b>	<pre> D 5 LD T0 ^ 6▶+P 6 K80 6 K5                 </pre>	The <b>GO</b> key deletes the command at the cursor position. The step number is brought forward.

↓

The "ANI MO" command was deleted.

20.2.5 Using Help function

**HELP** is input to use the Help function.  
 Input of **HELP** displays the Help function menus in each mode. Select the corresponding item for execution.

(1) Reading the command in the sequence program

Example of reading the area using the "MOV" command in the sequence program.

[Operation example]

1) <b>READ</b> → <b>HELP</b>	<pre>***HELP MENU*** 1: READ 2: COMMENT DISPLAY    CLEAR:END</pre>	Input the <b>HELP</b> key in the Read mode.
2) <b>1</b>	<pre>*** READ *** 1/2 1: STEP 2: INSTRUCTION CLEAR:END HELP:MENU</pre>	Select "Read".
3) <b>2</b>	<pre>*** READ *** KEY IN STEP NO.       [      ] CLEAR:END HELP:MENU</pre>	2: Select "Command".
4) <b>MOV</b>	<pre>*** READ *** KEY IN STEP NO.       [MOV  ] CLEAR:END HELP:MENU</pre>	Set the "MOV" command.
5) <b>GO</b>	<pre>R  6  D20 ^ 13▶MOV    13  D20    13  K2Y0018</pre>	Reading "MOV D20 K2Y0018" of the 13th step.
6) <b>GO</b>	<pre>R  6  D20 ^ 13▶MOV    13  D20    NOT FOUND</pre>	Message when the "MOV" command is not present after the 13th step.

↓

Now, reading the command with the Help function command specification is completed.

(2) Displaying Kana comment

The following example shows the procedure of displaying the Kana comment in the Read mode.

[Operation example]

1) <input type="button" value="HELP"/>	<pre> ***HELP MENU*** 1: READ 2: COMMENT DISPLAY CLEAR:END                     </pre>	Input the <input type="button" value="HELP"/> key in the Read mode.
2) <input type="button" value="2"/>	<pre> ***COMMENT DISP.*** 1: YES 2: NO CLEAR:END HELP:MENU                     </pre>	2: Select the Kana comment display.
3) <input type="button" value="1"/>	<pre> R 0▶LD X0000 ^ 1 OUT Y0020   2 LD X0000 Motor start limit                     </pre>	Select "1: Kana comment display". Display the Kana comment of the device at the cursor position.
4) <input type="button" value="↓"/>	<pre> R 0 LD X0000 ^ 1▶OUT Y0020   2 LD X0000 Motor start check                     </pre>	

20.3 Operation procedure list of list edit

20.3.1 Common operation

	Details	Purpose	Procedures (key input sequence)
Basic operation	Input of keyword at start-up	Input when the keyword is registered in the ACPU.	Keyword → <b>GO</b>
	Mode selection	Select the mode.	Mode key ( <b>READ</b> , <b>INSERT</b> , <b>PARAM</b> ) <b>SHIFT</b> → Mode key ( <b>WRITE</b> , <b>DELETE</b> , <b>OTHERS</b> )
	Switching of valid key	Switch the valid key (function indicated at the upper/lower part of the key) by a user.	<b>SHIFT</b> or <b>SET</b>
	Action for incorrect input	Perform the operation for incorrect key input.	<b>CLEAR</b> , Mode key or <b>SHIFT</b> → Mode key
	Operation of command help function	Perform operation with the Help function command specification.	Perform program display → <b>HELP</b> → <b>1</b> → <b>1</b> → <b>1</b> → Input the capital letter of the command. 
	Display of Comment	Display the comment stored in the ACPU.	Perform program display operation → <b>HELP</b> → <b>2</b> → <b>1</b> → <b>2</b>
Command input operation	Command code only	Input the command code only.	Command → <b>GO</b>
	Command code and 1 device	Input the command code and 1 device.	Command → <b>SP</b> → Device → Device No. → <b>GO</b>
	Other than above command key input)	Input the command other than above with the command key.	Input the <b>SP</b> between the device, the source data and the destination.
	Other than above (device key input)	Input the command other than above without the command key.	Input the <b>SP</b> between the command, the device, the source data and the destination.

20.3.2 Operation in Write mode (W)

	Details	Purpose	Procedures (key input sequence)
Continuous write in NOP		Set the specified range in the program to NOP.	Program display → <b>HELP</b> → <b>1</b> → <b>2</b> 
Write/modify (change) of program		Write the new program/modify (change)	<b>SHIFT</b> → <b>WRITE</b> → <b>SET</b> → Step number → <b>GO</b> → Com → <b>GO</b> 

20.3.3 Operation in Read mode (R)

Details	Purpose	Procedures (key input sequence)
Command reading with the specified step number	Read the command of the specified step number in the program.	READ → SET → Step number → GO → GO
Read the command with the specified command.	Read the specified command in the program.	READ → Command → Device → Device number → GO → GO
Read the command with the specified device.	Read the command with the specified device used in the program.	READ → SET → Device → Device number → GO → GO
Automatic scroll	Display the program with automatic scroll.	Read operation above → SET → ↑ ↓ SET → Step number → ↑ ↓ SET → SP → ↑ ↓

20.3.4 Operation in Insert mode (I)

Details	Purpose	Procedures (key input sequence)
Insert a command in the program.	Insert a command in the program.	INSERT → SET → Step number → GO → Com → GO ↑ ↓ mand
Move the program.	Move the whole program.	Display the program → HELP → 1 → 2 → Specify the movement start step. GO → Specify the movement end step. → GO → Specify the movement destination step. → GO
Copy the program.	Copy the program.	Display the program → HELP → 1 → 3 → Specify the copy start step. GO → Specify the copy end step. → GO → Specify the copy destination step. → GO

20.3.5 Operation in Delete (D) mode

Details	Purpose	Procedures (key input sequence)
Delete a command from the program.	Delete a command from the program.	SHIFT → DELETE → SET → Step number → GO → GO ↑ ↓
Delete the specified range of the program.	Specify the range of the program for deletion.	Display the program → HELP → 1 → 1 → Specify the deletion start step. GO → Specify the deletion end step. → GO
Delete the whole NOP.	Delete the whole NOP in the program.	Display the program → HELP → 1 → 2

20.3.6 Operation in Parameter mode (P)

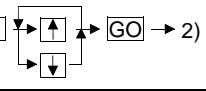
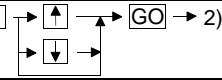
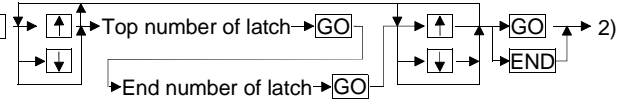
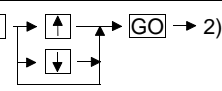
Details	Purpose	Procedures (key input sequence)
Clearing all parameters	Return the parameters to the initial setting status.	PARAM → 1 → ↑ → GO → END → ↑ → GO
Parameter setting (for A0J2HCPU)	Set the parameters for the A0J2HCPU.	PARAM → 2 → 1)
Setting of latch range	Select the latch range from "No latch", "1/2 latch" and "All latch".	1) → 1 →  → 2)
Setting of step relay	Set the availability (S1536 to 2047) of the step relay.	1) → 2 →  → 2)
Completion of setting (write)	When the parameter setting is complete, write the PLC CPU.	2) → CLEAR → END → ↑ → GO (End of writing is displayed.) Setting for multiple items is also available.
Parameter setting (other than A0J2HCPU)	Set the parameters other than A0J2HCPU.	PARAM → 2 → 1)
Setting of memory capacity	Set the main sequence program capacity and the file register capacity.	1) → 1 → Capacity → GO → END → 2) (For main, input unit: 1K step) 1) → 1 → ↓ → Capacity → GO → END → 2) (For sub, input unit: 1K step) 1) → 1 → ↓ → points → GO → END → 2) (For file register, input unit: 1K point)
M, L, S setting (other than AnA, AnUCPU)	Set the top device number used in the latch relay/step relay.	1) → 2 → Top number of L → GO → Top number of S → GO → 2)
M, L, S setting (AnA, AnUCPU only)	Set the top device number used in the latch relay/step relay/internal relay.	1) → 2 → Top number of L → GO → Top number of S → GO → Top number of M → GO → 2)
Timer setting (other than AnACPU)	Set the top device used in the low speed/high speed/retentive timers.	1) → 3 → Top number of timer → GO → 2)
Timer setting (AnACPU)	Set the number of timers used, the top device number that stores the setting value after T256, and the top device used in the low speed/high speed/retentive timers.	1) → 3 → No. of timers → GO → Top device for storage of setting values → GO → Top number of timer → GO → 2)
Counter setting (AnACPU only)	Set the number of counters used, and the top device number that stores the setting value after C255.	1) → 4 → No. of counters → GO → Top device for storage of setting values → GO → 2)
Setting of latch range	Set the range of the device for latch setting.	1) → 5 →  → 2)
WDT setting	Set the value of the watchdog timer in the unit of 10 ms.	1) → 6 → WDT value → GO → 2) (input unit: 10 ms)
Setting of I/O control system (only for A3HCPU and A3MCP)	Set the I/O control system.	1) → 7 →  → 2)
Completion of setting (write)	When parameter setting is complete, write the PLC CPU.	2) → CLEAR → END → ↑ → GO (End of writing is displayed.) Setting for multiple items is also available.



20.3.7 Operation in Other modes (O)

Details	Purpose	Procedures (key input sequence)
Error check	Operation that checks the error step number/error code for the current error in the ACPU. (other than AnA and AnUCPU)	<p>(Except AnA, AnUCPU) (AnA, AnUCPU)</p>
Program check	Check the program (double coil, command code, END command).	
Buffer memory batch monitoring	Monitor the buffer memory details of the special function unit.	<p>Buffer memory address</p>
Clock monitor	Monitor the clock data of the ACPU.	
Clearing of all PC memories	Clear all memories in the ACPU.	
Clearing of all programs	Clear all sequence program, microcomputer program and T/C setting value areas.	
Clearing of all device memories	Clear all details of the bit device and the word device in the ACPU.	
PLC No. setting	Set the PLC No. of other stations for access on the MELSECNET II (/B) or MELSECNET/10.	
Main/sub-program switching	Select the main/sub-program displayed on the list edit screen.	
Remote run/stop	Operate the run/stop status of the ACPU from the GOT.	
Read/write of machine language	Specify the memory address (absolute address) of the ACPU. Read the memory details and write the machine language to the memory.	

Chapter 21. Error Display and Corrective Actions for List Edit

21.1 Error detected with the list editor function

If an error is detected with the list editor function during operation of each mode, an error message appears at the 4th line of the display.

Error messages, display conditions and corrective actions are displayed below. If an error message appears, take the following actions to resume operation.

- 1) Check the error message.
  - 2) Remove the cause of the error.
  - 3) Input the corresponding key.
- (The error message disappears. The screen returns to the status before error.)

(Example)

R	0	▶	L D	X 0 0 0 0
▲	1		O R	Y 0 0 2 0
	2		A N I	M 1 0 0
	3		O U T	Y 0 0 2 0

**RST** → **M** → **0** → **GO** ..... Reading the step with the RST command.

R	0	▶	L D	X 0 0 0 0
▲	1		O R	Y 0 0 2 0
	2		A N I	M 1 0 0
	NOT FOUND			

← Display the error message.

**SET** ..... Delete the error message.

R	0	▶	L D	X 0 0 0 0
▲	1		O R	Y 0 0 2 0
	2		A N I	M 1 0 0

← The error message disappears.  
The next operation is resumed.

Error message	Display condition	Action
Address error	<ul style="list-style-type: none"> <li>In machine language writing, the address which was tried to be written was at the write-protect area.</li> </ul>	<ul style="list-style-type: none"> <li>Set the correct address.</li> </ul>
No corresponding program	<ul style="list-style-type: none"> <li>The specified command was not found.</li> </ul>	<ul style="list-style-type: none"> <li>Check the program.</li> </ul>
Memory cassette check	<ul style="list-style-type: none"> <li>In communication with the CPU for clearing the keyword or writing the parameter, the memory cassette is insufficient or not mounted.</li> </ul>	<ul style="list-style-type: none"> <li>Mount the memory cassette properly.</li> <li>Replace the memory cassette with a new one.</li> </ul>
Step over error	<ul style="list-style-type: none"> <li>The set step number is larger than the maximum step number.</li> </ul>	<ul style="list-style-type: none"> <li>Set the correct step number.</li> </ul>
Setting error	<ul style="list-style-type: none"> <li>Setting value is not correct.</li> </ul>	<ul style="list-style-type: none"> <li>Set the correct value.</li> </ul>
Not selectable	<ul style="list-style-type: none"> <li>The function which cannot be executed was selected.</li> </ul>	<ul style="list-style-type: none"> <li>Select other function.</li> </ul>
Operation error	<ul style="list-style-type: none"> <li>The set device symbol is incorrect.</li> </ul>	<ul style="list-style-type: none"> <li>Perform the correct key operation.</li> </ul>
Device error	<ul style="list-style-type: none"> <li>The specified command was not found.</li> <li>The device number exceeds the range.</li> </ul>	<ul style="list-style-type: none"> <li>Set the correct device symbol.</li> <li>Set the number within the range of CPU device.</li> </ul>
Identical coil	<ul style="list-style-type: none"> <li>The identical coil is found in the sequence program.</li> </ul>	<ul style="list-style-type: none"> <li>Proceed to the next operation if it does not affect the control.</li> <li>Correct the program if it affects the control.</li> </ul>
Command error	<ul style="list-style-type: none"> <li>When the program is read, it cannot be converted to the proper command.</li> </ul>	<ul style="list-style-type: none"> <li>When the CPU has detected the error, stop running of the operation. After resetting the CPU, check the command around the error. Write the correct command. (For check of the error step, refer to 20.3.7.)</li> </ul>
Command setting error	<ul style="list-style-type: none"> <li>The command set at the time of read, write or insert is not correct.</li> </ul>	<ul style="list-style-type: none"> <li>Set the correct command.</li> </ul>
Memory protect	<ul style="list-style-type: none"> <li>When writing in the Write or the Insert/Delete mode, the memory protect switch in the memory cassette is ON.</li> </ul>	<ul style="list-style-type: none"> <li>Turn OFF the memory protect switch in the memory cassette.</li> </ul>
Capacity over	<ul style="list-style-type: none"> <li>Memory assignment set in the parameter exceeded the capacity of the memory cassette.</li> </ul>	<ul style="list-style-type: none"> <li>Set the parameter within the capacity of the memory cassette.</li> </ul>
No END command	<ul style="list-style-type: none"> <li>There is no END command.</li> </ul>	<ul style="list-style-type: none"> <li>Write the END command at the last step of the program.</li> </ul>
PLC communication error	<ul style="list-style-type: none"> <li>When the list editor function is started, proper communication with the PLC is not made.</li> </ul>	<ul style="list-style-type: none"> <li>Restart the list editor function. If communication is not made properly, check the following: GOT main unit Connection of the cable CPU main unit (if any error has occurred)</li> </ul>
PC write error	<ul style="list-style-type: none"> <li>Correct writing was not made in the Write or Insert mode.</li> </ul>	<ul style="list-style-type: none"> <li>Check the setting of RAM/ROM.</li> <li>Check the RAM mounting.</li> <li>Check the setting of the memory protect switch in the CPU.</li> </ul>
PLC is running	<ul style="list-style-type: none"> <li>Writing, insertion or deletion was attempted during running of the CPU.</li> </ul>	<ul style="list-style-type: none"> <li>Stop the CPU.</li> </ul>
PC No. error	<ul style="list-style-type: none"> <li>The PLC number is set to other station.</li> </ul>	<ul style="list-style-type: none"> <li>Change the PLC number and set the station for access to the host.</li> </ul>

Error message	Display condition	Action
**KS over	<ul style="list-style-type: none"> <li>The value exceeding the range of the program capacity by **K steps was attempted to be set.</li> </ul>	<ul style="list-style-type: none"> <li>Reduce the program capacity by **K steps for setting.</li> </ul>
**KP over	<ul style="list-style-type: none"> <li>The value exceeding the range of the file register capacity by **K points was attempted to be set.</li> </ul>	<ul style="list-style-type: none"> <li>The value exceeding the range of the file register capacity by **K points was attempted to be set.</li> </ul>
Not available for QnACPU. Set the PLC No.	<ul style="list-style-type: none"> <li>The CPU at the list edit destination is QnACPU.</li> </ul>	<ul style="list-style-type: none"> <li>Set the PLC number and change the station for access.</li> </ul>
The keyword is not input. Set the PLC No.	<ul style="list-style-type: none"> <li>The  key was pressed without input of the keyword on the keyword input screen.</li> </ul>	<ul style="list-style-type: none"> <li>Set the PLC number and change the station for list edit. Or select the same station and input the keyword.</li> </ul>
The PLC parameter was changed. Restart the GOT system.	<ul style="list-style-type: none"> <li>The PLC parameter exceeding the file (R) register capacity was set.</li> </ul>	<ul style="list-style-type: none"> <li>Restart the GOT system if required.</li> </ul>
The PLC parameter was changed. Read the ladder monitor again.	<ul style="list-style-type: none"> <li>The capacity of the file (R) register was set.</li> </ul>	<ul style="list-style-type: none"> <li>Read the ladder monitor on the PLC again if required.</li> </ul>
The PLC program was edited. Read the ladder monitor again.	<ul style="list-style-type: none"> <li>Edit the PLC program.</li> </ul>	<ul style="list-style-type: none"> <li>Set the PLC number and change the station for access.</li> </ul>

21.2 Error of PLC CPU

When the error step read in other mode is performed, the error message and the error step of the current error in the ACPU are displayed.

Error messages, error details and corrective actions are displayed below. If an error message appears, take the following actions to resume operation.

- 1) Check the error message.
- 2) If the error code is not displayed, check the error code of special register D9008 with the system monitor function (Refer to Chapter 8.).
- 3) Remove the cause of the error.

(Display)

Example of display for an error in the CPU other than AnA and AnU

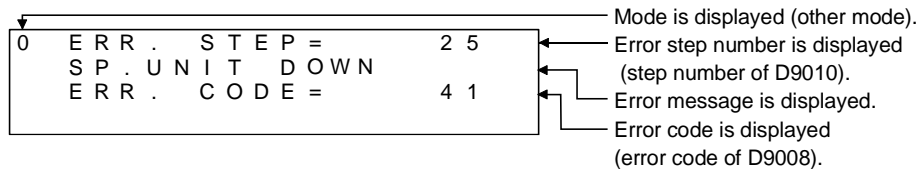

Example of display for an error in the AnA or AnUCPU

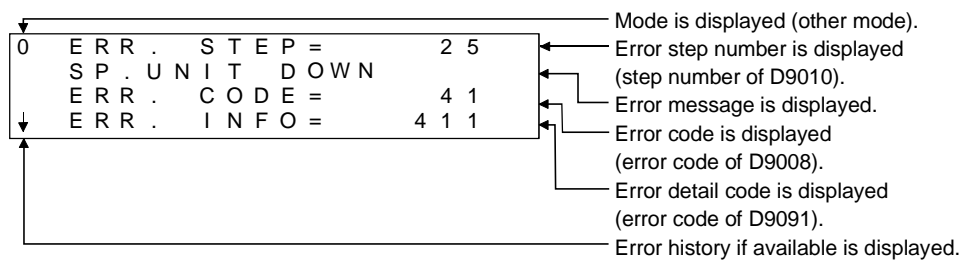

Example of next display for the display of " [«" above (error history is available)

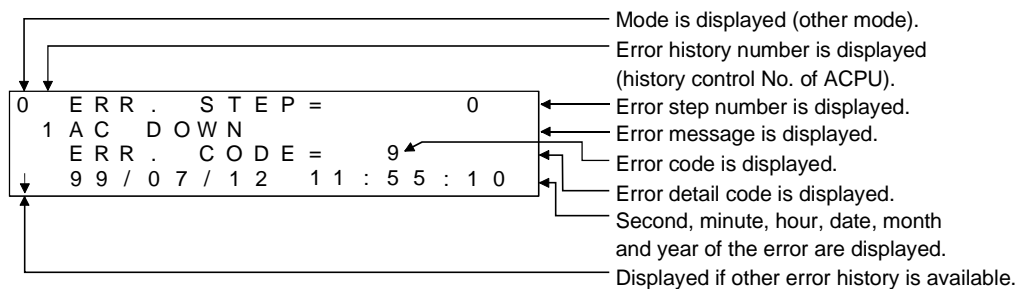

**POINT**

When an error message of the PLC CPU appears, refer to the ACPU programming manual (Common Command) and the user's manual for each CPU for corrective actions.

21.3 Error using list editor function on the link system

When the list editor function is used on the link system, the "PLC communication error (\*\*)" may appear. In this case, check the error details and the corrective actions.

Error No.	Error message	Action
2	Time-out error: No response to the request	Check the cable wiring.
4	Process cancel: New process request was given to the list editor function while the CPU is processing.	Perform correct key operations on the GOT.
5	Sum check error: A sum check error from the link communication has occurred.	There may be noise interference. Check the system again.
16	PLC No. error: There is no station corresponding to the PLC number.	Check the PLC number setting. Set the correct number.
19	This error may occur when the ACPU is reset during monitoring.	Perform the monitor setting again.
24	Remote error: Although remote stop/pause is performed from the computer link unit, remote run/stop is additionally performed.	Perform the remote run/stop/pause from either unit.
32	Link error: While the slave station is monitoring the master station, the master station is reset.	Perform the monitor setting again.
34	EEPROM failure: The EEPROM, cannot be written due to EEPROM failure.	Replace the EEPROM with a new one.

If error number "25" appears, the following causes are possible. Check the details and the corrective actions.

(1) When connected to the master station

Device number	Description	Details	
M9210	Link card error (for master station)	OFF: Normal ON : Error	The control depends on whether there is an error at the hardware of the link card. The link card in the CPU link unit is judged at the CPU. Replace the link unit.
M9224	Link status	OFF: Online ON : Offline, station-to-station test, or self-loopback test	The control depends on whether the master station itself is online or offline, or in the station-to-station mode or the self-loopback mode. Check the mode switch.
M9227	Loop test status	OFF: Not executed ON : Normal loop test and sub- loop test are being executed.	The control depends on whether the master station itself is executing the normal loop test or the sub-loop test.

(2) When connected to the local station

Device number	Description	Details	
M9211	Link card error (for local station)	OFF: Normal ON : Error	The control depends on whether there is an error at the hardware of the link card. The link card in the CPU link unit is judged at the CPU. Replace the link unit.
M9240	Link status	OFF: Online ON : Offline, station-to-station test, or self-loopback test	The control depends on whether the local station itself is online or offline, or in the station-to-station mode or the self-loopback mode. Check the mode switch.
M9257	Loop test status	OFF: Not executed ON : Normal loop test and sub- loop test are being executed.	The control depends on whether the local station itself is executing the normal loop test or the sub-loop test.

(3) When connected to the CPU in MELSECNET/10

An error in the MELSECNET/10 is reported using a four digit (hexadecimal) error number.

For details of the errors and corrective actions, see the MELSECNET/10 Network System Reference Manual.

POINT
-------

If an error code not listed in the previous page is displayed, contact the nearest of our system service centers, agents, and branch offices.
---

## INDEX

- [A]  
Adaptor address ..... 4 - 8
- [B]  
Batch monitor ..... 9 -10  
BM monitor ..... 9 -14  
Brightness/contrast  
adjustment of monitor screen ..... 4 - 3  
Brightness/contrast  
adjustment screen ..... 4 -16  
Buzzer sound ..... 4 - 8
- [C]  
Capacity of special module monitor data .... 3 - 5  
Connection transmission speed ..... 4 - 8  
Clock setting ..... 4 -12
- [D]  
Deleting a registered device ..... 9 - 9  
Detailed own station monitor ..... 17 - 3
- [E]  
Entry monitor ..... 9 - 7  
Error display and handling  
Ladder monitor function ..... 7 - 1  
Network monitor function ..... 18 - 1  
Special module monitor function ..... 14 - 1  
System monitor function ..... 10 - 1  
List editor function ..... 21 - 1
- [F]  
Features  
Ladder monitor function ..... 1 - 8  
Network monitor function ..... 1 -14  
Special module monitor function ..... 1 -12  
System monitor function ..... 1 -10  
Utility function ..... 1 - 6  
List editor function ..... 1 -16  
Function list ..... 1 - 2  
Functions requiring a memory board ..... 1 - 1
- [G]  
Grip switch ..... 4 - 9
- [H]  
Host (FF) address ..... 4 - 8  
How to display the utility menu ..... 4 - 2  
Human sensor detection sensitivity ..... 4 - 9  
Human sensor function ..... 4 - 9  
Human sensor OFF delay ..... 4 - 9
- [L]  
Ladder monitor function ..... 1 - 8  
Ladder read operation ..... 6 - 4  
List editor function ..... 1 -16
- [M]  
Memory capacity of OS ..... 1 - 5  
Memory information ..... 4 -11  
Message display ..... 4 - 8  
Microcomputer connection protocol ..... 4 - 8  
Microcomputer  
connection transmission speed ..... 4 - 8
- [N]  
Network monitor function ..... 1 -14
- [O]  
Operation for defect search ..... 6 -10  
Operation procedures  
Ladder monitor function ..... 5 - 1  
Network monitor function ..... 15 - 1  
Special module monitor function ..... 11 - 1  
System monitor function ..... 8 - 1  
List editor function ..... 19- 1  
Other station monitor ..... 17 - 9  
Outside speaker sound ..... 4 - 8  
Own station monitor ..... 17 - 1
- [P]  
Password ..... 4 - 15
- [Q]  
QC24 connection transmission speed ..... 4 - 8  
Quick test function ..... 9-19  
QBUS extension number ..... 4 - 8  
QBUS slot number ..... 4 - 8



[R]

Reading data from the PLC .....	6 - 1
Required equipment .....	2 - 1
Reverse display.....	4 - 8

[S]

Screen display and key functions	
Batch monitor .....	9 -11
BM monitor .....	9 -15
Detailed own station monitor .....	17- 3
Entry monitor .....	9 - 8
Ladder monitor function .....	6 -14
Other station monitor .....	17- 9
Special module monitor function .....	12- 1
System monitor function .....	9 - 1
TC monitor .....	9 -13
Screen cleanup .....	4 -13
Screen & OS copy .....	4 - 5
Screen save light.....	4 - 8
Screen saver function .....	4 - 9
Screen saver Human sensor .....	4 - 9
Screen save time .....	4 - 8
Security password .....	4 -14
Self test .....	4 -10
Setup .....	4 - 7
Special module monitor function .....	1 -12
Specifications	
Ladder monitor function .....	3 - 1
Network monitor function .....	3 - 8
Special module monitor function .....	3 - 4
System monitor function .....	3 - 2
List editor function .....	3 -10
Specifying the monitor station and device ...	9 - 4
Switching the display form .....	9 - 2
System monitor function .....	1 -10

[T]

TC monitor .....	9 -12
Test for special function module .....	12- 5
Test function .....	9 -16

[U]

Utility function .....	1 - 6
Utility function list .....	4 - 1



# WARRANTY

Please confirm the following product warranty details before starting use.

## 1. Gratis Warranty Term and Gratis Warranty Range

If any faults or defects (hereinafter "failure") found to be the responsibility of Mitsubishi occurs during use of the product within the gratis warranty term, the product shall be repaired at no cost via the dealer or Mitsubishi Service Company. Note that if repairs are required at a site overseas, on a detached island or remote place, expenses to dispatch an engineer shall be charged for.

### [Gratis Warranty Term]

The gratis warranty term of the product shall be for one year after the date of purchase or delivery to a designated place.

Note that after manufacture and shipment from Mitsubishi, the maximum distribution period shall be six (6) months, and the longest gratis warranty term after manufacturing shall be eighteen (18) months. The gratis warranty term of repair parts shall not exceed the gratis warranty term before repairs.

### [Gratis Warranty Range]

- (1) The range shall be limited to normal use within the usage state, usage methods and usage environment, etc., which follow the conditions and precautions, etc., given in the instruction manual, user's manual and caution labels on the product.
- (2) Even within the gratis warranty term, repairs shall be charged for in the following cases.
  1. failure occurring from inappropriate storage or handling, carelessness or negligence by the user. Failure caused by the user's hardware or software design.
  2. Failure caused by unapproved modifications, etc., to the product by the user.
  3. When the Mitsubishi product is assembled into a user's device, failure that could have been avoided if functions or structures, judged as necessary in the legal safety measures the user's device is subject to or as necessary by industry standards, had been provided.
  4. Failure that could have been avoided if consumable parts (battery, backlight, fuse, etc.) designated in the instruction manual had been correctly serviced or replaced.
  5. Failure caused by external irresistible forces such as fires or abnormal voltages, and failure caused by force majeure such as earthquakes, lightning, wind and water damage.
  6. Failure caused by reasons unpredictable by scientific technology standards at time of shipment from Mitsubishi.
  7. Any other failure found to not be the responsibility of Mitsubishi or the user.

## 2. Onerous repair term after discontinuation of production

- (1) Mitsubishi shall accept onerous product repairs for seven (7) years after production of the product is discontinued. Discontinuation of production shall be notified with Mitsubishi Technical Bulletins, etc.
- (2) Product supply (including repair parts) is not possible after production is discontinued.

## 3. Overseas service

Overseas, repairs shall be accepted by Mitsubishi's local overseas FA Center. Note that the repair conditions at each FA Center may differ.

## 4. Exclusion of chance loss and secondary loss from warranty liability

Regardless of the gratis warranty term, Mitsubishi shall not be liable for compensation to damages caused by any cause found not to be the responsibility of Mitsubishi, chance losses, lost profits incurred to the user by failures in Mitsubishi products, damages and secondary damages caused from special reasons regardless of Mitsubishi's expectations, compensation for accidents, and compensation for damages to products other than Mitsubishi products and other duties.

## 5. Changes in product specifications

The specifications given in the catalogs, manuals or technical documents are subject to change without prior notice.

## 6. Product application

- (1) In using the Mitsubishi MELSEC programmable logic controller, the usage conditions shall be that the application will not lead to a major accident even if any problem or fault should occur in the programmable logic controller device, and that backup and fail-safe functions are systematically provided outside of the device for any problem or fault.
- (2) The Mitsubishi general-purpose programmable logic controller has been designed and manufactured for applications in general industries, etc. Thus, applications in which the public could be affected such as in nuclear power plants and other power plants operated by respective power companies, and applications in which a special quality assurance system is required, such as for each Japan Railways company or the Department of Defense shall be excluded from the programmable logic controller applications.

Note that even with these applications, if the user approves that the application is to be limited and a special quality is not required, application shall be possible.

When considering use in aircraft, medical applications, railways, incineration and fuel devices, manned transport devices, equipment for recreation and amusement, and safety devices, in which human life or assets could be greatly affected and for which a particularly high reliability is required in terms of safety and control system, please consult with Mitsubishi and discuss the required specifications.

# GOT-A900 Series Operating Manual

(SW4D5C-GOTR-PACKE compatible  
Extended•Option Functions Manual)

MODEL	SW4-GOTR-O(SYS)-E
MODEL CODE	13J979
SH(NA)-080069-B(0005)MEE	

 **MITSUBISHI ELECTRIC CORPORATION**

HEAD OFFICE : MITSUBISHI DENKI BLDG MARUNOUCHI TOKYO 100-8310 TELEX : J24532 CABLE MELCO TOKYO  
NAGOYA WORKS : 1-14 , YADA-MINAMI 5 , HIGASHI-KU, NAGOYA , JAPAN

When exported from Japan, this manual does not require application to the  
Ministry of International Trade and Industry for service transaction permission.

Specifications subject to change without notice.