



PROGRAMMABLE CONTROLLERS
MELSEC-F

Side A JAPANESE
Side B ENGLISH

FX3U-232ADP-MB

Installation Manual



Manual Number	JY997D26401
Revision	F
Date	April 2015

This manual describes the part names, dimensions, mounting, and specifications of the product. Before use, read this manual and manuals of relevant products fully to acquire proficiency in handling and operating the product. Make sure to learn all the product information, safety information, and precautions.

And, store this manual in a safe place so that you can take it out and read it whenever necessary. Always forward it to the end user.

Registration:

MODBUS® is a registered trademark of Schneider Electric S.A. The company name and the product name to be described in this manual are the registered trademarks or trademarks of each company.

Effective April 2015
Specifications are subject to change without notice.
© 2007 Mitsubishi Electric Corporation

Safety Precaution (Read these precautions before use.)

This manual classify the safety precautions into two categories:

	WARNING	Indicates that incorrect handling may cause hazardous conditions, resulting in death or severe injury.
	CAUTION	Indicates that incorrect handling may cause hazardous conditions, resulting in medium or slight personal injury or physical damage.

Depending on circumstances, procedures indicated by **CAUTION** may also be linked to serious results. In any case, it is important to follow the directions for usage.

Associated Manuals

Manual name	Manual No.	Description
FX3S Series User's Manual - Hardware Edition	JY997D48601 MODEL CODE: 09R535	Explains FX3S Series PLC specification details for I/O, wiring, installation, and maintenance.
FX3G Series User's Manual - Hardware Edition	JY997D31301 MODEL CODE: 09R521	Explains FX3G Series PLC specification details for I/O, wiring, installation, and maintenance.
FX3GC Series User's Manual - Hardware Edition	JY997D45401 MODEL CODE: 09R533	Explains FX3GC Series PLC specification details for I/O, wiring, installation, and maintenance.
FX3U Series User's Manual - Hardware Edition	JY997D16501 MODEL CODE: 09R516	Explains FX3U Series PLC specification details for I/O, wiring, installation, and maintenance.
FX3UC Series User's Manual - Hardware Edition	JY997D28701 MODEL CODE: 09R519	Explains FX3UC Series PLC specification details for I/O, wiring, installation, and maintenance.
FX3S/FX3G/FX3GC/FX3U/FX3UC Series Programming Manual - Basic & Applied Instruction Edition	JY997D16601 MODEL CODE: 09R517	Describes PLC programming for basic/applied instructions and devices.
FX Series User's Manual - Data Communication Edition	JY997D16901 MODEL CODE: 09R715	Explains N:N link, parallel link, computer link, no protocol communication by RS instructions/FX2N-232IF.

Manual name	Manual No.	Description
FX3S/FX3G/FX3GC/FX3U/FX3UC Series User's Manual - MODBUS Serial Communication Edition	JY997D26201	Explains the MODBUS serial communication network.

How to obtain manuals
For the necessary product manuals or documents, consult with the Mitsubishi Electric dealer from where you purchase your product.

Applicable standards

FX3U-232ADP-MB units made in April, 2007 or later comply with the EC Directive (EMC Directive) and UL standards (UL, cUL). Further information can be found in the following manual.

- FX3S Series Hardware Manual (Manual No. JY997D48301)
- FX3G Series Hardware Manual (Manual No. JY997D46001)
- FX3GC Series Hardware Manual (Manual No. JY997D45201)
- FX3U Series Hardware Manual (Manual No. JY997D18801)
- FX3UC (D, DS, DSS) Series Hardware Manual (Manual No. JY997D28601)
- FX3UC-32MT-LT-2 Hardware Manual (Manual No. JY997D31601)

Regarding the standards that relate to the main unit, please refer to either the FX series product catalog or consult with your nearest Mitsubishi product provider.

Attention

- This product is designed for use in industrial applications.

Note

- Authorized Representative in the European Community:
Mitsubishi Electric Europe B.V.
Gothaer Str. 8, 40880 Ratingen, Germany

1. Outline

The FX3U-232ADP-MB communication special adapter (hereinafter called 232ADP-MB) is a special adapter for RS-232C communication with a 9-pin D-Sub connector. 232ADP-MB is an isolated signal exchange unit of the RS-232C serial data communication between the PLC and RS-232C device. The FX3U-232ADP-MB features all functionality that is available with the FX3U-232ADP, except that it also has MODBUS communication available.

1.1 Communication Function

Communication type	Function
Computer link	Data transfer via dedicated protocol between PLC and computer (specified as the master station).
Non-protocol communication	Serial communication via non-protocol between PLC and RS-232C device.
Programming communication	Optional port available for suitable programming tool when 232ADP-MB is connected to PLC.
Remote maintenance	Program transfer or monitoring enabled via modem and phone line connected to serial port of PLC.
MODBUS communication	Data transfer between a master and a slave.

1.2 Incorporated Items

Verify that the following product and items are included in the package:

Product	Accessories
FX3U-232ADP-MB communication special adapter	Installation manual (This manual)

1.3 External Dimensions and Part Names

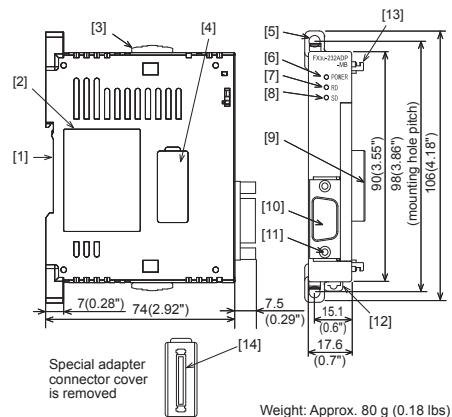

- DIN rail mounting groove (DIN rail: DIN46277)
- Name plate
- Special adapter slide lock: Used to connect special adapter on left side of this special adapter.
- Special adapter connector cover: Remove this cover for connecting special adapter on the left side.
- Direct mounting hole: 2 holes of $\phi 4.5$ (0.18") (mounting screw: M4 screw) Not used when connecting to FX3GC/FX3UC Series PLC.
- POWER LED (green): Lit while 5 V DC power is supplied from main unit.
- RD LED (red): Lit while receiving data from connected RS-232C device.
- SD LED (red): Lit while sending data to connected RS-232C device.
- Special adapter connector: Used to connect this special adapter to PLC main unit or special adapter.
- RS-232C connector (9-pin D-Sub, male): Connect RS-232C device to this RS-232C connector
- Screws to fix a cable connector: Screw holes #4-40UNC (inch screw thread)
- DIN rail mounting hook
- Special adapter fixing hook
- Special adapter connector: Used to connect communication special adapter or analog special adapter to this adapter on left side.

1.4 Pin Configuration

The pin configuration of the RS-232C port on the 232ADP-MB is as shown below.

Pin No.	Signal	Name	Function
1	CD (DCD)	Receive carrier detection	ON when carrier for data reception is detected. (RS-232C device to 232ADP-MB)
2	RD (RXD)	Receive data	Receive data (RS-232C device to 232ADP-MB)
3	SD (TXD)	Send data	Send data (232ADP-MB to RS-232C device)
4	ER (DTR)	Send request	ON when RS-232C device is ready to receive data. (232ADP-MB to RS-232C device)
5	SG (GND)	Signal ground	Signal ground (232ADP-MB to RS-232C device)
6	DR (DSR)	Send enable	ON when send request is made toward RS-232C device. (RS-232C device to 232ADP-MB)
7,8,9	Not used		

2. Channel Allocation

Up to two communication ports can be added to the main unit. Refer to the following manual for equipment that occupies communication ports.
→ FX Series User's Manual - Data Communication Edition

FX3S Series PLC

Communication port channels are automatically allocated.

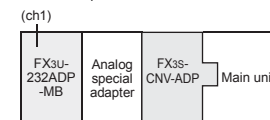

FX3G Series PLC

Communication port channels are automatically allocated.

- 40-point, 60-point type

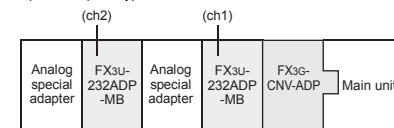

14-point, 24-point type

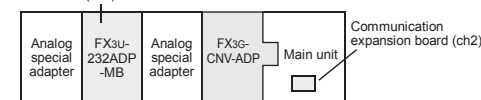

FX3GC Series PLC

Communication port channels are automatically allocated. The communication special adapter closer to the main unit is ch1.

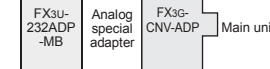

FX3U/FX3UC-32MT-LT(-2) Series PLC

Communication port channels are automatically allocated. The communication special adapter closer to the main unit is ch1.

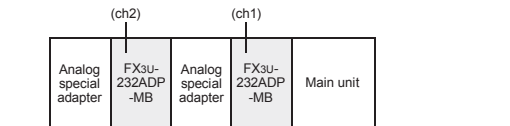

Using one communication special adapter + communication expansion board

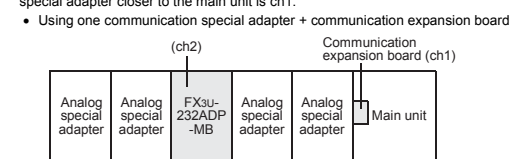

Using two communication special adapters

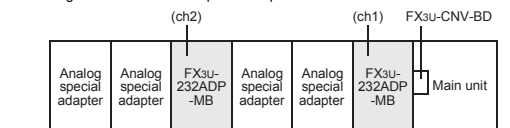

FX3uc (D, DS, DSS) Series PLC

Communication port channels are automatically allocated. The communication special adapter closer to the main unit is ch1.

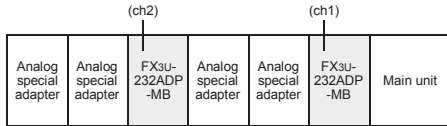

3. Installation

For installation/uninstallation details, refer to the respective PLC User's manual Hardware Edition.

INSTALLATION PRECAUTIONS **WARNING**

- Make sure to cut off all phases of the power supply externally before attempting installation or wiring work. Failure to do so may cause electric shock or damage to the product.

INSTALLATION PRECAUTIONS **CAUTION**

- Use the product within the generic environment specifications described in PLC main unit manual (Hardware Edition). Never use the product in areas with excessive dust, oily smoke, conductive dusts, corrosive gas (salt air, Cl₂, H₂S, SO₂, or NO₂), flammable gas, vibration or impacts, or expose it to high temperature, condensation, or rain and wind. If the product is used in such conditions, electric shock, fire, malfunctions, deterioration or damage may occur.
- When drilling screw holes or wiring, make sure cutting or wire debris does not enter the ventilation slits. Failure to do so may cause fire, equipment failures or malfunctions.
- Do not touch the conductive parts of the product directly. Doing so may cause device failures or malfunctions.
- Connect special adapter securely to their designated connectors. Loose connections may cause malfunctions.

3.1 Connection to the PLC

This section describes the connection method to the PLC (FX3u Series PLC is used for the following example). For installation method to other PLCs, refer to the respective PLC User's manual Hardware Edition.

Procedure

- Turn off the power. Disconnect all the cables connected to the PLC main unit and special adapter. Dismount the main unit and special adapter mounted on DIN rail or mounted directly using screws.
- Install an expansion board to the main unit. For installation of expansion board, refer to the following manual: → FX3u Series User's Manual - Hardware Edition
- Remove the special adapter connector cover on the expansion board (Right fig.A). In case of connecting this product to another special adapter, please replace the "expansion board" in the above description with a "special adapter" and perform the procedure as indicated.
- Slide the special adapter slide lock (Right fig.B) of the main unit. In case of connecting this product to another special adapter, please replace the "main unit" in the above description with a "special adapter" and perform the procedure as indicated. (Please replace the following procedures similarly.)
- Connect the special adapter (Right fig.C) to the main unit as shown on the right.
- Slide back the special adapter slide lock (Right fig.B) of the main unit to fix the special adapter (Right fig.C).

Connection precautions

Connect all the high-speed I/O special adapters before connecting other special adapters when they are used in combination. Do not connect a high-speed I/O special adapter on the left side of a communication or analog special adapter.

4. Wiring

For wiring details, refer to the following manual.
→ FX Series User's Manual - Data Communication Edition
→ FX3s/FX3g/FX3gc/FX3u/FX3uc Series User's Manual - MODBUS Serial Communication Edition

WIRING PRECAUTIONS **WARNING**

- Make sure to cut off all phases of the power supply externally before attempting installation or wiring work. Failure to do so may cause electric shock or damage to the product.

WIRING PRECAUTIONS **CAUTION**

- When drilling screw holes or wiring, make sure cutting or wire debris does not enter the ventilation slits. Failure to do so may cause fire, equipment failures or malfunctions.
- Make sure to observe the following precautions in order to prevent any damage to the machinery or accidents due to abnormal data written to the PLC under the influence of noise:
 - Do not bundle the main circuit line together with or lay it close to the main circuit, high-voltage line or load line. Otherwise, noise disturbance and/or surge induction are likely to take place. As a guideline, lay the control line at least 100mm (3.94") or more away from the main circuit or high-voltage lines.

5. Specification

STARTUP AND MAINTENANCE PRECAUTIONS **CAUTION**

- Do not disassemble or modify the unit. Doing so may cause fire, equipment failures, or malfunctions.
 - For repair, contact your local Mitsubishi Electric representative.
- Do not drop the product or exert strong impact to it. Doing so may cause damage.

DISPOSAL PRECAUTIONS **CAUTION**

- Please contact a certified electronic waste disposal company for the environmentally safe recycling and disposal of your device.

TRANSPORTATION AND STORAGE PRECAUTIONS **CAUTION**

- The product is a precision instrument. During transportation, avoid any impacts. Failure to do so may cause failures in the product. After transportation, verify the operations of the product.

5.1 Applicable PLC

Model name	Applicability
FX3s Series PLC	Ver. 1.00 or later for all communication functions
FX3G Series PLC	Ver. 1.30 or later for MODBUS communication Ver. 1.00 or later for all communication functions except MODBUS
FX3GC Series PLC	Ver. 1.40 or later for all communication functions
FX3U Series PLC	Ver. 2.40 or later for MODBUS communication Ver. 2.20 or later for all communication functions except MODBUS
FX3UC Series PLC	Ver. 2.40 or later for MODBUS communication Ver. 1.00 or later for all communication functions except MODBUS

The version number can be checked by monitoring D8001/D8101, as well as the last three digits indicate the version number.

5.2 General Specifications

Items other than the following are equivalent to the those of the PLC main unit. For general specifications, refer to the respective PLC User's manual Hardware Edition.

Item	Specification
Dielectric withstand voltage	500 V AC, one minute
Insulation resistance	5 MΩ or more by 500 V DC megger

5.3 Power Supply Specification

Item	Specification
Current consumption	30 mA 5 V DC power is supplied internally from the main unit.

5.4 Performance Specification

Item	Specification
Transmission standard	Conforming to RS-232C
Type of isolation	Photocoupler isolation
Transmission distance	15 m (49' 2") or less
Connection method	9-pin D-Sub connector (male)
Number of occupied I/O points	0 point (This number is not related to the maximum number of input/output points of the PLC.)
Communication method	Full-duplex
Baud rate	Computer link, and Non-protocol Items other than the following are equivalent to the those of the PLC main unit. For general specifications, refer to the respective PLC User's manual Hardware Edition.: 300/600/1200/2400/4800/9600/19200/38400 ^{*1} bps Programming communication: 9600/19200/38400/57600/115200 bps Remote maintenance: 9600 bps MODBUS communication ^{*2} : 300/600/1200/2400/4800/9600/19200/38400 ^{*3} /57600 ^{*3} /115200 ^{*3} bps
Communication format	Computer link (dedicated protocol: format 1/format 4), Non-protocol, Programming communication, Remote maintenance, and MODBUS communication
LED display: LED color	Power: green, RD: red, SD: red

*1 Applicable for FX3u/FX3uc Series PLC Ver. 2.41 or later and FX3s/FX3g/FX3gc Series PLC.

*2 When you set the baud rate to 38400 bps or more in a FX3s/FX3g/FX3gc Series PLC, please set D8411 (D8431) to be 3 ms or more. When D8411 (D8431) is set at less than 3 ms, it may not be able to communicate normally.

*3 Applicable for products manufactured in July, 2012 or later (manufacturer's serial number: 127**** or later). The year and month of production of the special adapter can be checked from the manufacturer's serial number "S/N" indicated on the label. For manufacturer's serial number, refer to the following manual.

→ FX3s/FX3g/FX3gc/FX3u/FX3uc SERIES USER'S MANUAL - MODBUS Serial Communication Edition

This manual confers no industrial property rights or any rights of any other kind, nor does it confer any patent licenses. Mitsubishi Electric Corporation cannot be held responsible for any problems involving industrial property rights which may occur as a result of using the contents noted in this manual.

Warranty

Mitsubishi will not be held liable for damage caused by factors found not to be the cause of Mitsubishi; opportunity loss or lost profits caused by faults in the Mitsubishi products; damage, secondary damage, accident compensation caused by special factors unpredictable by Mitsubishi; damages to products other than Mitsubishi products; and to other duties.

For safe use

- This product has been manufactured as a general-purpose part for general industries, and has not been designed or manufactured to be incorporated in a device or system used in purposes related to human life.
- Before using the product for special purposes such as nuclear power, electric power, aerospace, medicine or passenger movement vehicles, consult with Mitsubishi Electric.
- This product has been manufactured under strict quality control. However when installing the product where major accidents or losses could occur if the product fails, install appropriate backup or failsafe functions in the system.

MITSUBISHI ELECTRIC CORPORATION

HEAD OFFICE : TOKYO BUILDING, 2-7-3 MARUNOUCHI, CHIYODA-KU, TOKYO 100-8310, JAPAN

FX3U-232ADP-MB

Installation Manual



Manual Number	JY997D26401
Revision	F
Date	April 2015

This manual describes the part names, dimensions, mounting, and specifications of the product. Before use, read this manual and manuals of relevant products fully to acquire proficiency in handling and operating the product. Make sure to learn all the product information, safety information, and precautions. And, store this manual in a safe place so that you can take it out and read it whenever necessary. Always forward it to the end user.

Registration:
MODBUS[®] is a registered trademark of Schneider Electric S.A. The company name and the product name to be described in this manual are the registered trademarks or trademarks of each company.

Effective April 2015
Specifications are subject to change without notice.
© 2007 Mitsubishi Electric Corporation

Safety Precaution (Read these precautions before use.)

This manual classifies the safety precautions into two categories:
⚠ **WARNING** and ⚠ **CAUTION**

	Indicates that incorrect handling may cause hazardous conditions, resulting in death or severe injury.
	Indicates that incorrect handling may cause hazardous conditions, resulting in medium or slight personal injury or physical damage.

Depending on circumstances, procedures indicated by ⚠ **CAUTION** may also be linked to serious results.
In any case, it is important to follow the directions for usage.

Associated Manuals

Manual name	Manual No.	Description
FX3S Series User's Manual - Hardware Edition	JY997D48601 MODEL CODE: 09R535	Explains FX3S Series PLC specification details for I/O, wiring, installation, and maintenance.
FX3G Series User's Manual - Hardware Edition	JY997D31301 MODEL CODE: 09R521	Explains FX3G Series PLC specification details for I/O, wiring, installation, and maintenance.
FX3GC Series User's Manual - Hardware Edition	JY997D45401 MODEL CODE: 09R533	Explains FX3GC Series PLC specification details for I/O, wiring, installation, and maintenance.
FX3U Series User's Manual - Hardware Edition	JY997D16501 MODEL CODE: 09R516	Explains FX3U Series PLC specification details for I/O, wiring, installation, and maintenance.
FX3UC Series User's Manual - Hardware Edition	JY997D28701 MODEL CODE: 09R519	Explains FX3UC Series PLC specification details for I/O, wiring, installation, and maintenance.
FX3S/FX3G/FX3GC/FX3U/FX3UC Series Programming Manual - Basic & Applied Instruction Edition	JY997D16601 MODEL CODE: 09R517	Describes PLC programming for basic/applied instructions and devices.
FX Series User's Manual - Data Communication Edition	JY997D16901 MODEL CODE: 09R715	Explains N-N link, parallel link, computer link, no protocol communication by RS instructions/FX2N-232IF.

FX3UC (D, DS, DSS) Series PLC

Communication port channels are automatically allocated. The communication special adapter closer to the main unit is ch1.

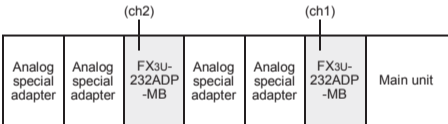

3. Installation

For installation/uninstallation details, refer to the respective PLC User's manual Hardware Edition.

INSTALLATION PRECAUTIONS ⚠ **WARNING**
• Make sure to cut off all phases of the power supply externally before attempting installation or wiring work.
Failure to do so may cause electric shock or damage to the product.

INSTALLATION PRECAUTIONS ⚠ **CAUTION**
• Use the product within the generic environment specifications described in PLC main unit manual (Hardware Edition).
Never use the product in areas with excessive dust, oily smoke, conductive dusts, corrosive gas (salt air, Cl₂, H₂S, SO₂, or NO₂), flammable gas, vibration or impacts, or expose it to high temperature, condensation, or rain and wind.
If the product is used in such conditions, electric shock, fire, malfunctions, deterioration or damage may occur.
• When drilling screw holes or wiring, make sure cutting or wire debris does not enter the ventilation slits.
Failure to do so may cause fire, equipment failures or malfunctions.
• Do not touch the conductive parts of the product directly.
Doing so may cause device failures or malfunctions.
• Connect special adapter securely to their designated connectors.
Loose connections may cause malfunctions.

3.1 Connection to the PLC

This section describes the connection method to the PLC (FX3U Series PLC is used for the following example).
For installation method to other PLCs, refer to the respective PLC User's manual Hardware Edition.

Procedure
1) Turn off the power.
Disconnect all the cables connected to the PLC main unit and special adapter.
Dismount the main unit and special adapter mounted on DIN rail or mounted directly using screws.

2) Install an expansion board to the main unit.
For installation of expansion board, refer to the following manual:
→ FX3U Series User's Manual - Hardware Edition

3) Remove the special adapter connector cover on the expansion board (Right fig.A).
In case of connecting this product to another special adapter, please replace the 'expansion board' in the above description with a 'special adapter' and perform the procedure as indicated.

4) Slide the special adapter side lock (Right fig.B) of the main unit.
In case of connecting this product to another special adapter, please replace the 'main unit' in the above description with a 'special adapter' and perform the procedure as indicated. (Please replace the following procedures similarly.)

5) Connect the special adapter (Right fig.C) to the main unit as shown on the right.

6) Slide back the special adapter side lock (Right fig.B) of the main unit to fix the special adapter (Right fig.C).

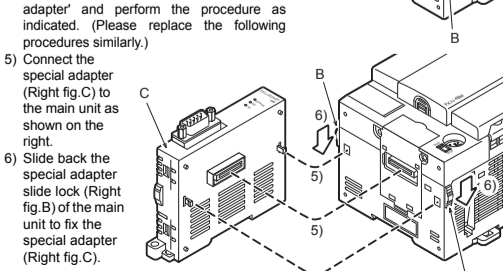

Connection precautions

Connect all the high-speed I/O special adapters before connecting other special adapters when they are used in combination.
Do not connect a high-speed I/O special adapter on the left side of a communication or analog special adapter.

Manual name	Manual No.	Description
FX3S/FX3G/FX3GC/FX3U/FX3UC Series User's Manual - MODBUS Serial Communication Edition	JY997D26201	Explains the MODBUS serial communication network.

How to obtain manuals
For the necessary product manuals or documents, consult with the Mitsubishi Electric dealer from where you purchase your product.

Applicable standards
FX3U-232ADP-MB units made in April, 2007 or later comply with the EC Directive (EMC Directive) and UL standards (UL, cUL). Further information can be found in the following manual.
→ FX3S Series Hardware Manual (Manual No. JY997D48301)
→ FX3G Series Hardware Manual (Manual No. JY997D46001)
→ FX3GC Series Hardware Manual (Manual No. JY997D45201)
→ FX3U Series Hardware Manual (Manual No. JY997D18801)
→ FX3UC (D, DS, DSS) Series Hardware Manual (Manual No. JY997D28601)
→ FX3UC-32MT-LT-2 Hardware Manual (Manual No. JY997D31601)

Regarding the standards that relate to the main unit, please refer to either the FX series product catalog or consult with your nearest Mitsubishi product provider.
Attention
• This product is designed for use in industrial applications.
Note
• Authorized Representative in the European Community:
Mitsubishi Electric Europe B.V.
Gothaer Str. 8, 40880 Ratingen, Germany

1. Outline

The FX3U-232ADP-MB communication special adapter (hereinafter called 232ADP-MB) is a special adapter for RS-232C communication with a 9-pin D-Sub connector. 232ADP-MB is an isolated signal exchange unit of the RS-232C serial data communication between the PLC and RS-232C device.
The FX3U-232ADP-MB features all functionality that is available with the FX3U-232ADP, except that it also has MODBUS communication available.

1.1 Communication Function

Communication type	Function
Computer link	Data transfer via dedicated protocol between PLC and computer (specified as the master station).
Non-protocol communication	Serial communication via non-protocol between PLC and RS-232C device.
Programming communication	Optional port available for suitable programming tool when 232ADP-MB is connected to PLC.
Remote maintenance	Program transfer or monitoring enabled via modem and phone line connected to serial port of PLC.
MODBUS communication	Data transfer between a master and a slave.

1.2 Incorporated Items

Verify that the following product and items are included in the package:

Product	FX3U-232ADP-MB communication special adapter
Accessories	Installation manual (This manual)

1.3 External Dimensions and Part Names

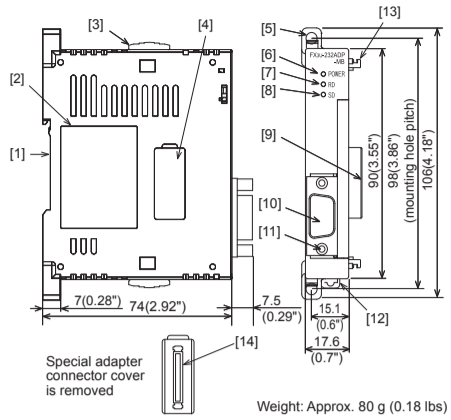

- DIN rail mounting groove (DIN rail: DIN46277)
- Name plate
- Special adapter side lock: Used to connect special adapter on left side of this special adapter.
- Special adapter connector cover: Remove this cover for connecting special adapter on the left side.
- Direct mounting hole: 2 holes of $\phi 4.5$ (0.18") (mounting screw: M4 screw) Not used when connecting to FX3G/FX3GC Series PLC.
- POWER LED (green): Lit while 5 V DC power is supplied from main unit.
- RD LED (red): Lit while receiving data from connected RS-232C device.
- SD LED (red): Lit while sending data to connected RS-232C device.
- Special adapter connector: Used to connect this special adapter to PLC main unit or special adapter.
- RS-232C connector (9-pin D-Sub, male): Connect RS-232C device to this RS-232C connector
- Screws to fix a cable connector: Screw holes #4-40UNC (inch screw thread)
- DIN rail mounting hook
- Special adapter fixing hook
- Special adapter connector: Used to connect communication special adapter or analog special adapter to this adapter on left side.

1.4 Pin Configuration

The pin configuration of the RS-232C port on the 232ADP-MB is as shown below.

Pin No.	Signal	Name	Function
1	CD (DCD)	Receive carrier detection	ON when carrier for data reception is detected. (RS-232C device to 232ADP-MB)
2	RD (RXD)	Receive data	Receive data (RS-232C device to 232ADP-MB)
3	SD (TXD)	Send data	Send data (232ADP-MB to RS-232C device)
4	ER (DTR)	Send request	ON when RS-232C device is ready to receive data. (232ADP-MB to RS-232C device)
5	SG (GND)	Signal ground	Signal ground (232ADP-MB to RS-232C device)
6	DR (DSR)	Send enable	ON when send request is made toward RS-232C device. (RS-232C device to 232ADP-MB)
7, 8, 9		Not used	

2. Channel Allocation

Up to two communication ports can be added to the main unit.
Refer to the following manual for equipment that occupies communication ports.
→ FX Series User's Manual - Data Communication Edition

FX3S Series PLC

Communication port channels are automatically allocated.

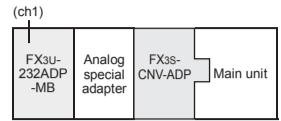

FX3G Series PLC

Communication port channels are automatically allocated.

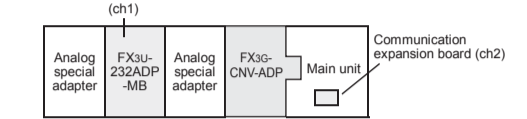
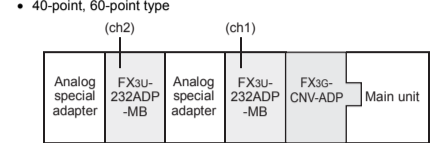

40-point, 60-point type

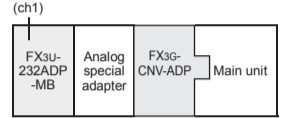

14-point, 24-point type

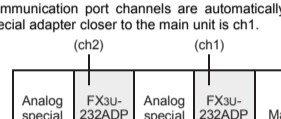

FX3GC Series PLC

Communication port channels are automatically allocated. The communication special adapter closer to the main unit is ch1.

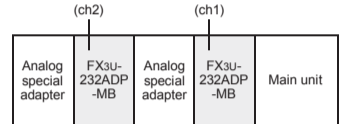

FX3U/FX3UC-32MT-LT(-2) Series PLC

Communication port channels are automatically allocated. The communication special adapter closer to the main unit is ch1.

• Using one communication special adapter + communication expansion board

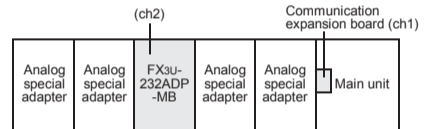

• Using two communication special adapters

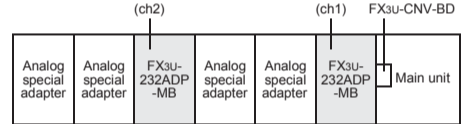

4. Wiring

For wiring details, refer to the following manual.
→ FX Series User's Manual - Data Communication Edition
→ FX3S/FX3G/FX3GC/FX3U/FX3UC Series User's Manual - MODBUS Serial Communication Edition

WIRING PRECAUTIONS ⚠ **WARNING**
• Make sure to cut off all phases of the power supply externally before attempting installation or wiring work.
Failure to do so may cause electric shock or damage to the product.

WIRING PRECAUTIONS ⚠ **CAUTION**
• When drilling screw holes or wiring, make sure cutting or wire debris does not enter the ventilation slits.
Failure to do so may cause fire, equipment failures or malfunctions.
• Make sure to observe the following precautions in order to prevent any damage to the machinery or accidents due to abnormal data written to the PLC under the influence of noise:
- Do not bundle the main circuit line together with or lay it close to the main circuit, high-voltage line or load line.
Otherwise, noise disturbance and/or surge induction are likely to take place.
As a guideline, lay the control line at least 100mm (3.94") or more away from the main circuit or high-voltage lines.

5. Specification

STARTUP AND MAINTENANCE PRECAUTIONS ⚠ **CAUTION**
• Do not disassemble or modify the unit.
Doing so may cause fire, equipment failures, or malfunctions.
* For repair, contact your local Mitsubishi Electric representative.
• Do not drop the product or exert strong impact to it.
Doing so may cause damage.

DISPOSAL PRECAUTIONS ⚠ **CAUTION**
• Please contact a certified electronic waste disposal company for the environmentally safe recycling and disposal of your device.

TRANSPORTATION AND STORAGE PRECAUTIONS ⚠ **CAUTION**
• The product is a precision instrument. During transportation, avoid any impacts.
Failure to do so may cause failures in the product. After transportation, verify the operations of the product.

5.1 Applicable PLC

Model name	Applicability
FX3S Series PLC	Ver. 1.00 or later for all communication functions
FX3G Series PLC	Ver. 1.30 or later for MODBUS communication Ver. 1.00 or later for all communication functions except MODBUS
FX3GC Series PLC	Ver. 1.40 or later for all communication functions
FX3U Series PLC	Ver. 2.40 or later for MODBUS communication Ver. 2.20 or later for all communication functions except MODBUS
FX3UC Series PLC	Ver. 2.40 or later for MODBUS communication Ver. 1.00 or later for all communication functions except MODBUS

The version number can be checked by monitoring D8001/D8101, as well as the last three digits indicate the version number.

5.2 General Specifications

Items other than the following are equivalent to the those of the PLC main unit.
For general specifications, refer to the respective PLC User's manual Hardware Edition.

Item	Specification
Dielectric withstand voltage	500 V AC, one minute
Insulation resistance	5 MΩ or more by 500 V DC megger

5.3 Power Supply Specification

Item	Specification
Current consumption	30 mA 5 V DC power is supplied internally from the main unit.

5.4 Performance Specification

Item	Specification
Transmission standard	Conforming to RS-232C
Type of isolation	Photocoupler isolation
Transmission distance	15 m (49' 2") or less
Connection method	9-pin D-Sub connector (male)
Number of occupied I/O points	0 point (This number is not related to the maximum number of input/output points of the PLC.)
Communication method	Full-duplex
Baud rate	Computer link, and Non-protocol Items other than the following are equivalent to the those of the PLC main unit. For general specifications, refer to the respective PLC User's manual Hardware Edition.: 300/600/1200/2400/4800/9600/19200/38400 ^{*1} bps Programming communication: 9600/19200/38400/57600/115200 bps Remote maintenance: 9600 bps MODBUS communication ^{*2} : 300/600/1200/2400/4800/9600/19200/38400 ^{*3} /57600 ^{*3} /115200 ^{*3} bps
Communication format	Computer link (dedicated protocol: format 1/format 4), Non-protocol, Programming communication, Remote maintenance, and MODBUS communication
LED display: LED color	Power: green, RD: red, SD: red

^{*1} Applicable for FX3U/FX3UC Series PLC Ver. 2.41 or later and FX3S/FX3G/FX3GC Series PLC.

^{*2} When you set the baud rate to 38400 bps or more in a FX3S/FX3G/FX3GC Series PLC, please set D8411 (D8431) to be 3 ms or more. When D8411 (D8431) is set at less than 3 ms, it may not be able to communicate normally.

^{*3} Applicable for products manufactured in July, 2012 or later (manufacturer's serial number: 127**** or later). The year and month of production of the special adapter can be checked from the manufacturer's serial number "S/N" indicated on the label.
For manufacturer's serial number, refer to the following manual.
→ FX3S/FX3G/FX3GC/FX3U/FX3UC SERIES USER'S MANUAL - MODBUS Serial Communication Edition

This manual confers no industrial property rights or any rights of any other kind, nor does it confer any patent licenses. Mitsubishi Electric Corporation cannot be held responsible for any problems involving industrial property rights which may occur as a result of using the contents noted in this manual.

Warranty
Mitsubishi will not be held liable for damage caused by factors found not to be the cause of Mitsubishi; opportunity loss or lost profits caused by faults in the Mitsubishi products; damage, secondary damage, accident compensation caused by special factors unpredictable by Mitsubishi; damages to products other than Mitsubishi products; and to other duties.

For safe use
• This product has been manufactured as a general-purpose part for general industries, and has not been designed or manufactured to be incorporated in a device or system used in purposes related to human life.
• Before using the product for special purposes such as nuclear power, electric power, aerospace, medicine or passenger movement vehicles, consult with Mitsubishi Electric.
• This product has been manufactured under strict quality control. However when installing the product where major accidents or losses could occur if the product fails, install appropriate backup or failsafe functions in the system.