

mitsubishi

GT15 CC-Link IE CONTROLLER

NETWORK COMMUNICATION UNIT

User's Manual

GT15-J71GP23-SX

Thank you for purchasing the GOT1000 Series.

Prior to use, please read both this manual and detailed manual thoroughly to fully understand the product.

MODEL	GT15-J71GP23-SX-U
MODEL CODE	1D7M76
IB(NA)-0800412-E(1410)MEE	

GRAPHIC OPERATION TERMINAL

GOT1000

●SAFETY PRECAUTIONS●

(Always read these precautions before using this equipment.)

Before using this product, please read this manual and the relevant manuals introduced in this manual carefully and pay full attention to safety to handle the product correctly.

The precautions given in this manual are concerned with this product. In this manual, the safety precautions are ranked as "WARNING" and "CAUTION".



WARNING

Indicates that incorrect handling may cause hazardous conditions, resulting in death or severe injury.



CAUTION

Indicates that incorrect handling may cause hazardous conditions, resulting in medium or slight personal injury or physical damage.

Note that the  CAUTION level may lead to a serious accident according to the circumstances.

Always follow the precautions of both levels because they are important to personal safety.

Please save this manual to make it accessible when required and always forward it to the end user.

[DESIGN PRECAUTIONS]

WARNING

- If a communication fails in data link, the faulty station holds the data link data generated before the communication error. Create an interlock circuit in the sequence program using the communication status information in order that the system will operate safely.
Failure to do so may cause mis-outputs or malfunctions, resulting in accidents.
Check the faulty station and the operation status during communication error by referring to the relevant manuals.
- Some failures of cable or communication unit may cause the GOT to keep the outputs on or off.
Create an external circuit for monitoring output signals that may lead to serious accidents.
Failure to do so may cause mis-outputs or malfunctions, resulting in accidents.
- If a communication error (including cable disconnection) occurs during monitoring, the communication between the GOT and programmable controller CPU may be interrupted and the GOT may be inoperative.
For bus connection : The programmable controller CPU is down and the GOT is inoperative.
For other than above: The GOT is inoperative.
When configuring a system including the GOT, the possibility of GOT communication error must be considered; make sure the operation significant for the system will be performed by switches on devices other than the GOT.
Failure to do so may cause mis-outputs or malfunctions, resulting in accidents.
- Laser diodes are used in optical transceivers for the CC-Link IE Controller Network. The class of these laser diodes is Class 1.

CAUTION

- Do not bunch the control wires or communication cables with the main circuit or power wires, or lay them close to each other.
As a guide, separate the lines by a distance of at least 100mm (3.94 inches) otherwise malfunctions may occur due to noise.

[INSTALLATION PRECAUTIONS]

WARNING

- Be sure to shut off all phases of the external power supply used by the system before mounting or removing this unit to/from the GOT.
Not doing so can cause a unit failure or malfunction.

CAUTION

- Use this unit in the environment that satisfies the general specifications described in the User's Manual for the GOT used.
Not doing so can cause an electric shock, fire, malfunction or product damage or deterioration.
- When installing this unit to the GOT, fit it to the connection interface of the GOT and tighten the mounting screws in the specified torque range (0.36 N•m to 0.48 N•m) with a Phillips-head screwdriver No.2.
Undertightening can cause a drop, failure or malfunction.
Overtightening can cause a drop, failure or malfunction due to screw or unit damage.
- Do not directly touch the conductive part or electronic components of the unit.
This may cause the unit to fail or malfunction.

[WIRING PRECAUTIONS]

WARNING

- Be sure to shut off all phases of the external power supply used by the system before wiring.
Failure to do so may cause electric shock, product damage or malfunctions.

[WIRING PRECAUTIONS]

CAUTION

- Be careful not to let foreign matter such as dust or wire chips get inside the unit. This may cause a fire, failure or malfunctions.
- Make sure to securely connect the cable to the connector of unit. Incorrect connection may cause malfunctions.
- Make sure to fix communication cables and power cables to the unit by ducts or clamps. Failure to do so may cause damage of the unit or the cables due to accidental pull or unintentional shifting of the cables, or malfunctions due to poor contact of the cables.
- Do not hold the cable by hand and pull it out from the unit. When removing the cable from the unit, make sure to hold the connector by hand and pull it. Failure to do so may cause malfunctions or damage to the unit or cable.

[STARTUP AND MAINTENANCE PRECAUTIONS]

WARNING

- Do not touch the connector while power is on. Failure to do so may cause electric shock or malfunctions.
- Before starting cleaning, always shut off GOT power externally in all phases. Not doing so can cause a unit failure or malfunction.

[STARTUP AND MAINTENANCE PRECAUTIONS]

CAUTION

- Do not disassemble or modify any unit.
This will cause failure, malfunction, injuries, or fire.
- Do not touch the conductive areas and electronic parts of this unit directly.
Doing so can cause a unit malfunction or failure.
- Make sure to externally shut off all phases of the power supply before cleaning the unit and retightening unit mounting screws.
Failure to do so may cause the unit to fail or malfunction.
Loose tightening may cause a fall of the unit, short circuits, or malfunctions.
Overtightening may damage the screws and/or the unit, resulting in a fall of the unit, short circuits or malfunctions.
- Make sure to touch the grounded metal to discharge the electricity charged in the body, etc., before touching the unit.
Failure to do so may cause a failure or malfunctions of the unit.

[DISPOSAL PRECAUTIONS]

CAUTION

- Dispose of this product as industrial waste.

[TRANSPORTATION PRECAUTIONS]

CAUTION

- Make sure to transport the GOT main unit and/or relevant unit(s) in the manner they will not be exposed to the impact exceeding the impact resistance described in the general specifications of Use this unit in the environment that satisfies the general specifications described in the User's Manual for the GOT used, as they are precision devices.
Failure to do so may cause the unit to fail.
Check if the unit operates correctly after transportation.
- When fumigants that contain halogen materials such as fluorine, chlorine, bromine, and iodine are used for disinfecting and protecting wooden packaging from insects, they cause malfunction when entering our products. Please take necessary precautions to ensure that remaining materials from fumigant do not enter our products, or treat packaging with methods other than fumigation (heat method). Additionally, disinfect and protect wood from insects before packing products.

REVISIONS

* The manual number is noted at the lower right of the top cover.

Print Date	*Manual Number	Revision
Jan., 2008	IB(NA)-0800412-A	First edition
Jan., 2009	IB(NA)-0800412-B	<u>Patial addition</u> Chapter 1, 2, 4, 7
Jun., 2009	IB(NA)-0800412-C	<u>Partial corrections</u> Compliance with the EMC and Low Voltage Directives
Jun., 2011	IB(NA)-0800412-D	<u>Partial corrections</u> Chapter 7 <u>Patial addition</u> Compliance with the Radio Waves Act (South Korea)
Oct., 2014	IB(NA)-0800412-E	<u>Partial corrections</u> SAFETY PRECAUTIONS Chapter 4, 7

This manual confers no industrial property rights or any rights of any other kind, nor does it confer any patent licenses. Mitsubishi Electric Corporation cannot be held responsible for any problems involving industrial property rights which may occur as a result of using the contents noted in this manual.

© 2008 MITSUBISHI ELECTRIC CORPORATION

CONTENTS

1. OVERVIEW	1
2. SPECIFICATIONS	1
3. PART NAMES	3
4. INSTALLATION PROCEDURE	6
5. PRECAUTIONS FOR WIRING CABLES	8
6. WIRING METHOD	9
7. EXTERNAL DIMENSIONS	10

Manuals

The following shows manuals relevant to this product.

Detailed Manual

Manual name	Manual number (Model code)
GT16 User's Manual (Hardware) (Sold separately)	SH-080928ENG (1D7MD3)
GT15 User's Manual (Sold separately)	SH-080528ENG (1D7M23)
GOT1000 Series Connection Manual (Mitsubishi Products) for GT Works3 (Sold separately)	SH-080868ENG (1D7MC2)

Relevant Manuals

For relevant manuals, refer to the PDF manuals stored in the DVD-ROM for the drawing software used.

Compliance with the EMC and Low Voltage Directives

To configure a system meeting the requirements of the EMC and Low Voltage Directives when incorporating the Mitsubishi GOT (EMC and Low Voltage Directives compliant) into other machinery or equipment, refer to "EMC AND LOW VOLTAGE DIRECTIVES" of the General Description included with the GOT used.

The CE mark, indicating compliance with the EMC and Low Voltage Directives, is printed on the rating plate of the GOT.

Compliance with the Radio Waves Act (South Korea)

This product complies with the Radio Waves Act (South Korea).

Note the following when using the product in South Korea.

이 기기는 업무용 (A 급) 전자파적합기기로서 판매자 또는 사용자는 이 점을 주의하시기 바라며, 가정외의 지역에서 사용하는 것을 목적으로 합니다.
(The product is for business use (Class A) and meets the electromagnetic compatibility requirements. The seller and the user must note the above point, and use the product in a place except for home.)

Packing List

The following items are included.

Model	Product	Quantity
GT15-J71GP23-SX	CC-Link IE Controller Network communication unit	1
	Mounting screw set (4 screws, 4 stickers)	1
	Extension interface relay board	1

1. OVERVIEW

This manual explains the CC-Link IE Controller Network communication unit (hereinafter referred to as CC-Link IE communication unit).

The CC-Link IE communication unit allows the GOT1000 series to function as a normal station on the CC-Link IE Controller Network.

Refer to the User's Manual for the GOT used for GOT to which this unit can be installed.

When using the CC-Link IE Controller Network connection, make the communication setting to perform communication with programmable controllers.

For details of the CC-Link IE Controller Network connection, refer to GOT1000 Series Connection Manual.

2. SPECIFICATIONS

The performance specifications of the CC-Link IE communication unit are indicated below.

The general specifications of the CC-Link IE communication unit are the same as those of the GOT.

For the general specifications of the GOT, refer to the User's Manual for the GOT used.

Item		Specification
Max. link points per network	LB	32K points (32768 points, 4KB)
	LW	128K points (131072 points, 256KB)
	LX	8K points (8192 points, 1KB)
	LY	8K points (8192 points, 1KB)
Max. link points per station	LB	16K points (16384 points, 2KB)
	LW	16K points (16384 points, 32KB)
	LX	8K points (8192 points, 1KB)
	LY	8K points (8192 points, 1KB)
Transient transmission capacity	Up to 1920 bytes	
Communication speed	1Gbps	
Communication method	Token ring	
Number of stations per network	Up to 120 stations (Control station: 1, Normal station: 119) **1	
Connection cable	Fiber-optic cable (Multi-mode fiber) (☞ CC-Link IE Controller Network Reference Manual)	
Overall cable distance	66000m (When 120 stations are connected)	

Item	Specification
Station-to-station distance (Max.)	550m (Core/Clad = 50/125 (μ m))
Max. number of networks	239
Max. number of groups	32
Transmission path	Duplex loop
Optical fiber specifications	1000BASE-SX(MMF) fiber-optic cable
Standard	IEC60793-2-10 Types A1a.1 (50/125 μ m multimode)
Transmission loss (max.)	3.5 (dB/km) or less (λ = 850nm)
Transmission band (min.)	500 (MHz·km) or more (λ = 850nm)
Connector specifications	Duplex LC connector
Standard	IEC61754-20: Type LC connector
Connection loss	0.3 (dB) or less
Polished surface	PC (Physical Contact) polishing
Internal current consumption	1.07A
Weight	0.28kg (0.62lb)

*1 : Please note that use of a fiber-optic cable requires the expertise, special tools and dedicated connector for connection. Please contact your local Mitsubishi Electric System & Service Co., Ltd. or representative, for the purchase of the required items.

3. PART NAMES

The following describes part names and descriptions of the CC-Link IE communication unit.

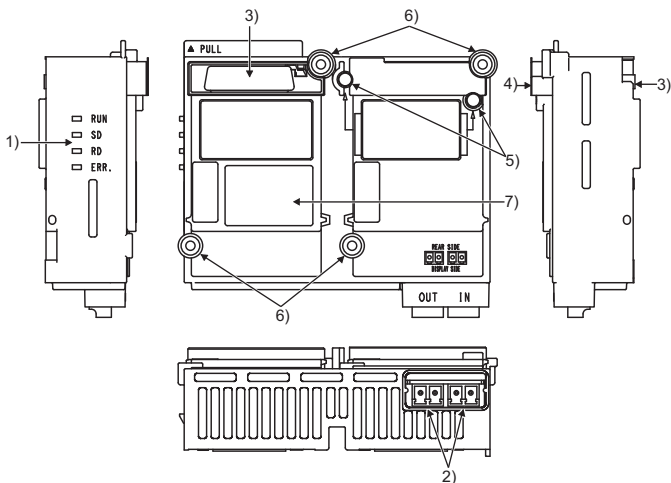

No.	Name	Description
1)	Indicator LED	Indicates the operating status of the CC-Link IE communication unit. (☞ (1) in this section)
2)	Connector (IN side, OUT side)	Connector for connecting a fiber-optic cable (☞ (2) in this section)
3)	Interface connector	Extension connector installed to a front extension unit or the GOT
4)	Extension connector	Extension connector to which a back extension unit is installed
5)	Board fixing screw	Screws for fixing the extension interface relay board
6)	Mounting screw	Mounting screws fixed with a front extension unit or the GOT
7)	Rating plate	-

(1) Indicator LED

A LED indicates the status of the CC-Link IE communication unit and the communication status.

When the LED is lighted up, there are two display formats, one for the normal mode and the other for the error mode.

(1) Normal mode

If any communication error occurs in the normal mode, specify the error cause by the [NETWK unit status display] screen of the GOT utility.

Refer to the User's Manual for the GOT used for details on the [NETWK unit status display] screen.

LED name	Status	Description
RUN	Off	The GOT is being reset.
	On	The unit is in a normal status.
SD	Off	Not sending data
	On	Sending data
RD	Off	Not receiving data
	On	Receiving data
ERR.	Off	Normal status
	On	Communication error

- RUN
- SD
- RD
- ERR.

(2) Error mode

When the RUN LED is blinking, the LED display format is the error mode. In the error mode, if an error occurs, restart the GOT.

If the error mode is not released after restarting the GOT, the system alarm "460 Communication unit error" may occur.

For system alarms, refer to the User's Manual for the GOT used.

LED name	Status	Description
RUN	Blinking	Shows that it is in the error mode.
	On or off	No error
RD	Off	No hardware failure
	On	Hardware failure
ERR.	Off	No starting error
	On	Starting error

(2) Connector (IN side, OUT side)

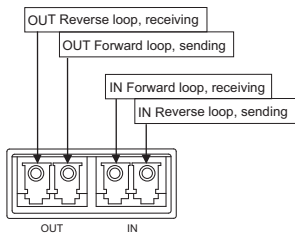

4. INSTALLATION PROCEDURE

The installation procedure for the CC-Link IE communication unit is explained using the GT1575.

- (1) Power off the GOT.
- (2) Remove two extension unit covers of the GOT.

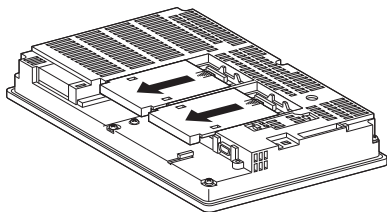

- (3) Attach the extension interface relay board to the extension interface 2 on the GOT.

After the installation, detach the connector cover from the extension interface relay board.

For the following GOT types, the extension interface relay board is not needed.

- GT1655,GT155□ of the GOT1000 series
- GT27,GT25 of the GOT2000 series

- (4) Fit the CC-Link IE communication unit in the GOT case.

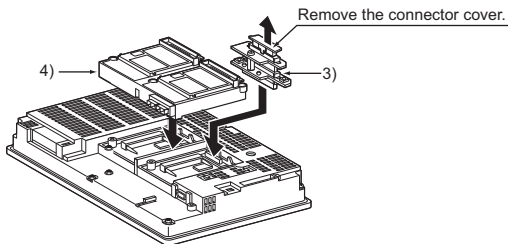

- (5) Fix the CC-Link IE communication unit by tightening its mounting screws (4 places) with a tightening torque of 0.36 to 0.48 N·m.

- (6) Fix the CC-Link IE communication unit by tightening two board fixing screws with a tightening torque of 0.36 to 0.48 N•m.

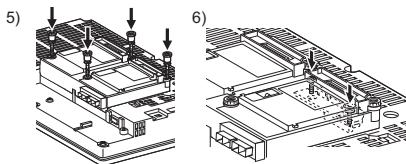

- (7) When installing an extension unit on the unit that has been installed, remove the connector cover and the stickers. When not installing an extension unit on the unit that has been installed, in order to avoid receiving electrostatic, stick accessory stickers to cover the top of mounting screws (4 places). Keep the connector cover fixed. Keep the accessory sticker stuck.

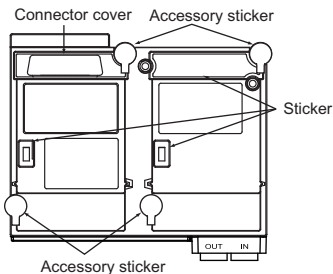

Point

Remove the screws that fixes the extension interface relay board before removing the unit.
(Above (6))

5. PRECAUTIONS FOR WIRING CABLES

- (1) Wire fiber-optic cables described in the following manual.
 - CC-Link IE Controller Network Reference Manual
- (2) For connecting fiber-optic cables to the unit, the bending radius of the cables must be within the specified range.
For the details, check the specifications of the cables to be used.
- (3) When wiring a fiber-optic cable, do not touch the fiber core of the cable connector or unit connector, or let dirt or dust collect on it.
If oil from the hands, dirt or dust should adhere to the core, the transmission loss will increase, causing a malfunction in the data link.
- (4) When connecting or removing the fiber-optic cables to/from the unit, hold the cable connector securely with the hands.
- (5) Connect the cable connector and unit connector securely until you hear a "click" sound.
- (6) For connecting or removing the fiber-optic cables, be sure to shut off all phases of the external power supplies used in the system.
- (7) Please wire IN/OUT of the connector for the cable correctly.
After wiring, perform a loop test or station-to-station test or others to confirm if the setting and wiring of CC-Link IE communication unit have been done properly.
For testing methods, refer to the following manual.
 - CC-Link IE Controller Network Reference ManualMiswiring may cause the following and others.
 - Baton passing error
 - No loopback at any stations
 - Failed station that cannot reconnect to the network with reclosing the power

6. WIRING METHOD

(1) Connection method

Connect fiber-optic cables between OUT and IN side connectors as shown below.

Note that there is no need to connect the cables in the order of station numbers.

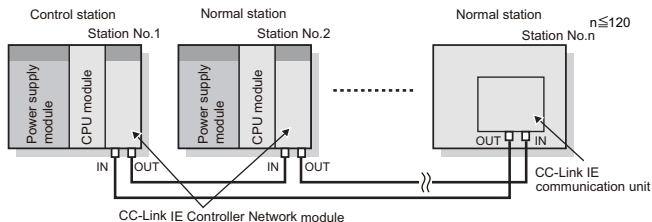

(2) Connecting fiber-optic cable

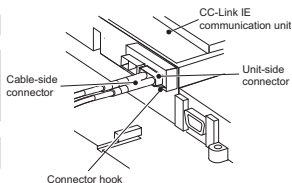
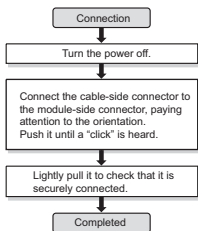

(3) Disconnecting fiber-optic cable

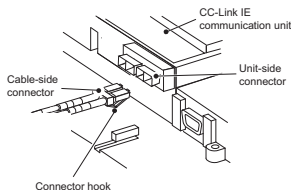
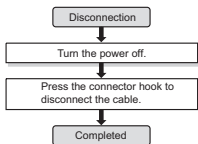

7. EXTERNAL DIMENSIONS

(1) CC-Link IE communication unit

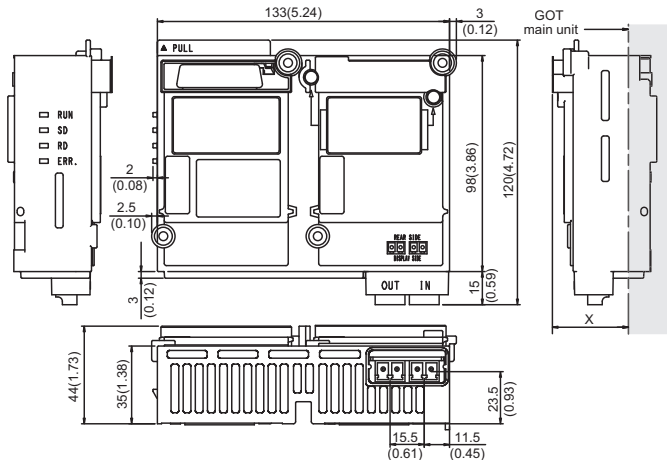

Dimensions of X when the CC-Link IE communication unit is mounted to the GOT.

GOT	GT16	GT15	GT27	GT25
15"	33.5(1.32)	35(1.38)	37(1.46)	-
12.1"	32(1.26)	32(1.26)	37(1.46)	37(1.46)
10.4"	35(1.38)	35(1.38)	37(1.46)	37(1.46)
8.4"	37(1.46)	37(1.46)	37(1.46)	37(1.46)
5.7"	37(1.46)	37(1.46)	-	-

Unit:mm (inch)

(2) Extension interface relay board

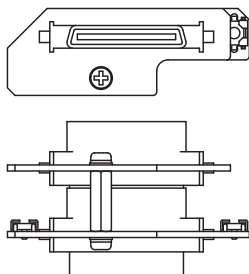

Warranty

Mitsubishi will not be held liable for damage caused by factors found not to be the cause of Mitsubishi; machine damage or lost profits caused by faults in the Mitsubishi products; damage, secondary damage, accident compensation caused by special factors unpredictable by Mitsubishi; damages to products other than Mitsubishi products; and to other duties.

For safe use

- This product has been manufactured as a general-purpose part for general industries, and has not been designed or manufactured to be incorporated in a device or system used in purposes related to human life.
- Before using the product for special purposes such as nuclear power, electric power, aerospace, medicine or passenger movement vehicles, consult with Mitsubishi.
- This product has been manufactured under strict quality control. However, when installing the product where major accidents or losses could occur if the product fails, install appropriate backup or failsafe functions in the system.

Country/Region	Sales office/Tel	Country/Region	Sales office/Tel
U.S.A	Mitsubishi Electric Automation Inc. 500 Corporate Woods Parkway Vernon Hills, IL 60061, U.S.A. Tel : +1-847-478-2100	Hong Kong	Mitsubishi Electric Automation (Hong Kong) Ltd. 10th Floor, Manulife Tower, 169 Electric Road, North Point, Hong Kong Tel : +852-2887-8870
Brazil	MELCO-TEC Rep. Com.e Assessoria Tecnica Ltda. Rua Correia Dias, 184, Edificio Paraiso Trade Center-8 andar Paraiso, Sao Paulo, SP Brazil Tel : +55-11-5908-8331	China	Mitsubishi Electric Automation (China) Ltd. 4/F Zhi Fu Plaza, No.80 Xin Chang Road, Shanghai 200003, China Tel : +86-21-6120-0808
Germany	Mitsubishi Electric Europe B.V. German Branch Gothaer Strasse 8 D-40880 Ratingen, GERMANY Tel : +49-2102-486-0	Taiwan	Setsuyo Enterprise Co., Ltd. 6F No.105 Wu-Kung 3rd.Rd, Wu-Ku Hsiang, Taipei Hsine, Taiwan Tel : +886-2-2299-2499
U.K	Mitsubishi Electric Europe B.V. UK Branch Travellers Lane, Hatfield, Hertfordshire., AL10 8XB, U.K. Tel : +44-1707-276100	Korea	Mitsubishi Electric Automation Korea Co., Ltd. 1480-6, Gayang-dong, Gangseo-ku Seoul 157-200, Korea Tel : +82-2-3660-9552
Italy	Mitsubishi Electric Europe B.V. Italian Branch Centro Dir. Colleone, Pal. Perseo-Ingr.2 Via Paracelso 12, I-20041 Agrate Brianza., Milano, Italy Tel : +39-039-60531	Singapore	Mitsubishi Electric Asia Pte, Ltd. 307 Alexandra Road #05-01/02, Mitsubishi Electric Building, Singapore 159943 Tel : +65-6470-2460
Spain	Mitsubishi Electric Europe B.V. Spanish Branch Carretera de Rubi 76-80, E-08190 Sant Cugat del Valles, Barcelona, Spain Tel : +34-93-565-3131	Thailand	Mitsubishi Electric Automation (Thailand) Co., Ltd. Bang-Chan Industrial Estate No.111 Moo 4, Serithai Rd, T.Kannayao, A.Kannayao, Bangkok 10230 Thailand Tel : +66-2-517-1326
France	Mitsubishi Electric Europe B.V. French Branch 25, Boulevard des Bouvets, F-92741 Nanterre Cedex, France Tel : +33-1-5568-5568	Indonesia	P.T. Autoteknikindo Sumber Makmur Muara Karang Selatan, Block A/Utara No.1 Kav. No.11 Kawasan Industri Pergudangan Jakarta - Utara 14440, P.O.Box 5045 Jakarta, 11050 Indonesia Tel : +62-21-6630833
South Africa	Circuit Breaker Industries Ltd. Private Bag 2016, ZA-1600 Isando, South Africa Tel : +27-11-928-2000	India	Messung Systems Pvt, Ltd. Electronic Sadan NO:III Unit No15, M.I.D.C Bhosari, Pune-411026, India Tel : +91-20-2712-3130
		Australia	Mitsubishi Electric Australia Pty. Ltd. 348 Victoria Road, Rydalmere, N.S.W 2116, Australia Tel : +61-2-9684-7777

MITSUBISHI ELECTRIC CORPORATION

HEAD OFFICE : TOKYO BUILDING, 2-7-3 MARUNOUCHI, CHYODAI-KU, TOKYO 100-8310, JAPAN
NAGOYA WORKS : 1-14, YADA-MINAMI 5-CHOME, HIGASHI-KU, NAGOYA, JAPAN

When exported from Japan, this manual does not require application to the Ministry of Economy, Trade and Industry for service transaction permission.

Specifications subject to change without notice.
Printed in Japan, October 2014.