

## Mitsubishi Programmable Controller

MELSEC **Q** series

# Channel Isolated Pulse Input Module User's Manual

---

-QD60P8-G  
-GX Configurator-CT (SW0D5C-QCTU-E)

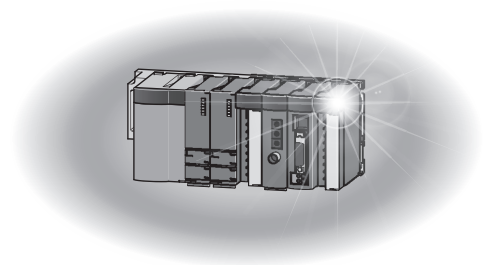



## • SAFETY PRECAUTIONS •

(Read these precautions before using this product.)

Before using this product, please read this manual and the relevant manuals introduced in this manual carefully and pay full attention to safety to handle the product correctly.

The precautions given in this manual are concerned with this product only. For the safety precautions of the programmable controller system, refer to the user's manual for the CPU module used.

In this manual, the safety precautions are classified into two levels: "⚠ WARNING" and "⚠ CAUTION".



Indicates that incorrect handling may cause hazardous conditions, resulting in death or severe injury.

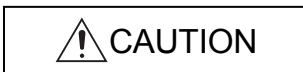

Indicates that incorrect handling may cause hazardous conditions, resulting in minor or moderate injury or property damage.

Under some circumstances, failure to observe the precautions given under "⚠ CAUTION" may lead to serious consequences.

Observe the precautions of both levels because they are important for personal and system safety. Make sure that the end users read this manual and then keep the manual in a safe place for future reference.

### [Design Precautions]

#### ⚠ WARNING

- Do not write data into the "read-only area" in the buffer memory of the intelligent function module. In addition, do not turn on/off the "Reserved (N/A)" signals among the I/O signals transferred to/from the programmable controller CPU.  
Doing so can malfunction the programmable controller system.

#### ⚠ CAUTION

- Do not bunch the control wires or pulse input wires with the main circuit or power wires, or install them close to each other.  
They should be installed 150 mm (5.9 inch) or more from each other.  
Not doing so could result in noise that may cause malfunction.

## [Installation Precautions]

### CAUTION

- Use the programmable controller in an environment that meets the general specifications contained in the CPU module User's Manual.  
Using this programmable controller in an environment outside the range of the general specifications may cause electric shock, fire, malfunction, and damage to or deterioration of the product.
- While pressing the installation lever located at the bottom of module, insert the module fixing tab into the fixing hole in the base unit until it stops. Then, securely mount the module with the fixing hole as a supporting point.  
Improper installation may result in malfunction, breakdown or the module coming loose and dropping. Securely fix the module with screws if it is subject to vibration during use.
- Tighten the screws within the range of specified torque.  
If the screws are loose, it may cause the module to fallout, short circuits, or malfunction.  
If the screws are tightened too much, it may cause damage to the screw and/or the module, resulting in fallout, short circuits or malfunction.
- Be sure to shut off all phases of the external power supply used by the system before mounting or removing the module.  
Not doing so may cause electric shock or damage to the module.  
In the system where a CPU module supporting the online module change is used and on the MELSECNET/H remote I/O stations, modules can be replaced online (during energizing). However, there are some restrictions on replaceable modules and the replacement procedures are predetermined for each module.  
For details, refer to the chapter of the online module change in this manual.
- Do not install/remove the module to/from the base unit, or the terminal block to/from the module more than 50 times after the first use of the product. (IEC 61131-2 compliant) Failure to do so may cause malfunction.
- Do not directly touch the conductive area or electronic components of the module.  
Doing so may cause malfunction or failure in the module.

## [Wiring Precautions]

### WARNING

- Switch all phases of the external power supply off when installing or placing wiring. Not doing so may cause electric shock or damage to the product.
- Be careful not to let foreign matters such as sawdust or wire chips get inside the module.  
These may cause fires, failure or malfunction.
- The top surface of the module is covered with protective film to prevent foreign objects such as cable offcuts from entering the module when wiring.  
Do not remove this film until the wiring is complete.  
Before operating the system, be sure to remove the film to provide adequate heat ventilation.

## [Wiring Precautions]

### **WARNING**

- The cables connected to the module should be placed in a duct or fixed. Not doing so can cause the module or cables to be damaged when the cables swing, more or are pulled carefully, for example or to malfunction due to poor cable connection.

## [Wiring Precautions]

### CAUTION

- When removing the cable from the module, do not pull the cable.  
When disconnecting a cable without a terminal block, unscrew on the part that is connected to the module.  
Pulling the cable that is still connected to the module may cause malfunction or damage to the module or cable.
- Always ground the shielded cable for the programmable controller.  
There is a risk of electric shock or malfunction.
- Use applicable solderless terminals and tighten them with the specified torque.  
If any solderless spade terminal is used, it may be disconnected when the terminal screw comes loose, resulting in failure.
- When wiring, be sure to verify the rated voltage of the product as well as the terminal layout. Fire or failure may result if incorrect voltage is input or incorrect wiring is performed.

## [Startup/Maintenance Precautions]

### CAUTION

- Do not disassemble or modify the module.  
Doing so could cause failure, malfunction, injury or fire.
- Shut off the external power supply for the system in all phases before mounting or removing the module.  
Not doing so may cause failure or malfunction of the module.  
In the system where a CPU module supporting the online module change is used and on the MELSECNET/H remote I/O stations, modules can be replaced online (during energizing).  
However, there are some restrictions on replaceable modules and the replacement procedures are predetermined for each module.  
For details, refer to the chapter of the online module change in this manual.
- Do not install/remove the module to/from the base unit, or the terminal block to/from the module more than 50 times after the first use of the product. (IEC 61131-2 compliant)  
Failure to do so may cause malfunction.
- Do not touch the connector while the power is on.  
Doing so may cause malfunction.

## [Startup/Maintenance Precautions]

### CAUTION

- Shut off the external power supply for the system in all phases before cleaning the module or retightening the module fixing screws, terminal block screws, and terminal block fixing screws. Not doing so may cause failure or malfunction of the module.  
If the screws are loose, it may cause the module to fallout, short circuits, or malfunction.  
If the screws are tightened too much, it may cause damages to the screws and/or the module, resulting in the module falling out, short circuits or malfunction.
- Always make sure to touch the grounded metal to discharge the electricity charged in the body, etc., before touching the module.  
Failure to do so may cause a failure or malfunctions of the module.

## [Disposal Precautions]

### CAUTION

- When disposing of the product, handle it as industrial waste.

## • CONDITIONS OF USE FOR THE PRODUCT •

- (1) Mitsubishi programmable controller ("the PRODUCT") shall be used in conditions;
- i) where any problem, fault or failure occurring in the PRODUCT, if any, shall not lead to any major or serious accident; and
  - ii) where the backup and fail-safe function are systematically or automatically provided outside of the PRODUCT for the case of any problem, fault or failure occurring in the PRODUCT.

- (2) The PRODUCT has been designed and manufactured for the purpose of being used in general industries.

MITSUBISHI SHALL HAVE NO RESPONSIBILITY OR LIABILITY (INCLUDING, BUT NOT LIMITED TO ANY AND ALL RESPONSIBILITY OR LIABILITY BASED ON CONTRACT, WARRANTY, TORT, PRODUCT LIABILITY) FOR ANY INJURY OR DEATH TO PERSONS OR LOSS OR DAMAGE TO PROPERTY CAUSED BY the PRODUCT THAT ARE OPERATED OR USED IN APPLICATION NOT INTENDED OR EXCLUDED BY INSTRUCTIONS, PRECAUTIONS, OR WARNING CONTAINED IN MITSUBISHI'S USER, INSTRUCTION AND/OR SAFETY MANUALS, TECHNICAL BULLETINS AND GUIDELINES FOR the PRODUCT.

("Prohibited Application")

Prohibited Applications include, but not limited to, the use of the PRODUCT in;

- Nuclear Power Plants and any other power plants operated by Power companies, and/or any other cases in which the public could be affected if any problem or fault occurs in the PRODUCT.
- Railway companies or Public service purposes, and/or any other cases in which establishment of a special quality assurance system is required by the Purchaser or End User.
- Aircraft or Aerospace, Medical applications, Train equipment, transport equipment such as Elevator and Escalator, Incineration and Fuel devices, Vehicles, Manned transportation, Equipment for Recreation and Amusement, and Safety devices, handling of Nuclear or Hazardous Materials or Chemicals, Mining and Drilling, and/or other applications where there is a significant risk of injury to the public or property.

Notwithstanding the above, restrictions Mitsubishi may in its sole discretion, authorize use of the PRODUCT in one or more of the Prohibited Applications, provided that the usage of the PRODUCT is limited only for the specific applications agreed to by Mitsubishi and provided further that no special quality assurance or fail-safe, redundant or other safety features which exceed the general specifications of the PRODUCTS are required. For details, please contact the Mitsubishi representative in your region.



REVISIONS

\* The manual number is given on the bottom left of the back cover.

Print Date	* Manual Number	Revision
Jun., 2002	SH (NA)-080313E-A	First edition
Feb., 2003	SH (NA)-080313E-B	Correction SAFETY PRECAUTIONS, Section 2.1, Section 2.2, Section 6.2.2, Section 6.4, Section 6.5, Section 9.1.1
Jun., 2004	SH (NA)-080313E-C	Addition of program example for use on the remote I/O network. Correction SAFETY PRECAUTIONS, Section 2.2, Section 4.1, Section 6.4, Section 6.6, Chapter 7, Section 8.1, Section 8.3.2
Feb., 2006	SH (NA)-080313E-D	Correction SAFETY PRECAUTIONS, Conformation to the EMC Directive and Low Voltage Instruction, Section 2.2, Section 4.1, Section 6.2.2
Mar., 2006	SH (NA)-080313E-E	Correction SAFETY PRECAUTIONS, Section 4.4.2, 7.2, 7.2.1, 7.3, 7.3.1
Sep., 2006	SH (NA)-080313E-F	Correction SAFETY PRECAUTIONS
Jun., 2007	SH (NA)-080313E-G	Correction Generic Terms and Abbreviations, Section 2.1, 2.2, 3.1, 4.1, 4.4, 4.5, 5.1.1, 5.2.2, 6.2.1, 6.3 to 6.6, Chapter 8, Section 8.3, INDEX
Jan., 2008	SH (NA)-080313E-H	Correction Generic Terms and Abbreviations, Section 2.2, 2.3, Section 6.2.2
May, 2008	SH (NA)-080313E-I	Correction SAFETY PRECAUTIONS, Compliance with the EMC and Low Voltage Directives, Generic Terms and Abbreviations, Section 2.1, 2.3, 4.1, 4.4.1, 6.2.1, 6.3.1, 6.3.3, 8.1
Dec., 2010	SH (NA)-080313E-J	Addition of program example for use the utility package. Correction SAFETY PRECAUTIONS, Generic Terms and Abbreviations, Sections 1.2, 2.1 to 2.3, 3.1, 3.2, 3.5, 4.2, 4.3, 4.5, 5.1.1, 5.1.4, 5.2, 5.6, 6.2.1, 6.3.3, Chapter 7, Sections 7.1, 7.2, 7.2.1, 7.3, 7.3.1, 8.1, 9.1.1, 9.3, Appendix 1 Addition Sections 7.2.2, 7.3.2

Japanese Manual Version SH-080312-J

This manual confers no industrial property rights or any rights of any other kind, nor does it confer any patent licenses. Mitsubishi Electric Corporation cannot be held responsible for any problems involving industrial property rights which may occur as a result of using the contents noted in this manual.

© 2002 MITSUBISHI ELECTRIC CORPORATION

## INTRODUCTION

Thank you for purchasing the Mitsubishi programmable controller MELSEC-Q Series.  
Always read through this manual, and fully comprehend the functions and performance of the Q Series programmable controller before starting use to ensure correct usage of this product.

## CONTENTS

SAFETY PRECAUTIONS.....	A- 1
CONDITIONS OF USE FOR THE PRODUCT .....	A- 6
REVISIONS .....	A- 7
INTRODUCTION.....	A- 8
CONTENTS.....	A- 8
USING THIS MANUAL .....	A- 11
COMPLIANCE WITH THE EMC AND LOW VOLTAGE DIRECTIVES.....	A- 12
GENERIC TERMS AND ABBREVIATIONS .....	A- 12
COMPONENT LIST .....	A- 13
<b>1 OVERVIEW</b>	<b>1- 1 to 1- 4</b>
1.1 Overview.....	1- 1
1.2 Features .....	1- 1
<b>2 SYSTEM CONFIGURATION</b>	<b>2- 1 to 2- 7</b>
2.1 Applicable Systems.....	2- 1
2.2 Using the QD60P8-G with the Redundant CPU .....	2- 5
2.3 Checking Function Version, Serial Number, and Software Version.....	2- 6
<b>3 SPECIFICATIONS</b>	<b>3- 1 to 3- 14</b>
3.1 Performance Specifications .....	3- 1
3.2 List of Functions .....	3- 3
3.3 I/O Signals for Programmable Controller CPU .....	3- 4
3.3.1 List of I/O signals.....	3- 4
3.3.2 Details of I/O signals .....	3- 5
3.4 Buffer Memory.....	3- 8
3.4.1 List of buffer memory assignments.....	3- 8
3.4.2 Details of buffer memory.....	3- 9
3.5 Interface with External Devices .....	3- 14
<b>4 SETUP AND PROCEDURE BEFORE OPERATION</b>	<b>4- 1 to 4- 10</b>
4.1 Handling Precautions.....	4- 1
4.2 Procedure before Operation .....	4- 2
4.3 Part Identification Nomenclature .....	4- 3
4.4 Wiring.....	4- 4
4.4.1 Wiring precautions.....	4- 4
4.4.2 Wiring example.....	4- 6
4.5 Setting from GX Developer.....	4- 8
A - 8	A - 8

4.5.1 I/O assignment setting .....	4- 8
4.5.2 Switch setting for the intelligent function module .....	4- 9

<b>5 DETAILS AND SETTING OF FUNCTIONS</b>	<b>5- 1 to 5- 18</b>
---	----------------------

5.1 Count Operation .....	5- 1
5.1.1 Pulse input method .....	5- 1
5.1.2 Input pulse count operation .....	5- 2
5.1.3 Count value reading .....	5- 3
5.1.4 Count cycle changing .....	5- 4
5.2 Count Type Selection .....	5- 5
5.2.1 Linear counter operation .....	5- 5
5.2.2 Ring counter operation .....	5- 7
5.3 Input Pulse Value .....	5- 9
5.4 Comparison Output Function .....	5- 10
5.5 Counter Reset Function .....	5- 12
5.6 Pre-scale Function .....	5- 13
5.7 Movement Averaging Function .....	5- 15
5.8 Alarm Output Function .....	5- 16
5.9 Count Response Delay Time .....	5- 17

<b>6 UTILITY PACKAGE (GX Configurator-CT)</b>	<b>6- 1 to 6- 18</b>
---	----------------------

6.1 Utility Package Functions .....	6- 1
6.2 Installing and Uninstalling the Utility Package .....	6- 2
6.2.1 Handling precautions .....	6- 2
6.2.2 Operating environment .....	6- 4
6.3 Utility Package Operation .....	6- 6
6.3.1 Common utility package operations .....	6- 6
6.3.2 Operation overview .....	6- 8
6.3.3 Starting the intelligent function module utility .....	6- 10
6.4 Initial Setting .....	6- 12
6.5 Auto Refresh Setting .....	6- 14
6.6 Monitoring/Test .....	6- 16

<b>7 PROGRAMMING</b>	<b>7- 1 to 7- 23</b>
----------------------	----------------------

7.1 Programming Procedure .....	7- 2
7.2 For Use in Normal System Configuration .....	7- 3
7.2.1 Program example using the utility package .....	7- 4
7.2.2 Program example without using the utility package .....	7- 9
7.3 For Use on Remote I/O Network .....	7- 12
7.3.1 Program example using the utility package .....	7- 13
7.3.2 Program example without using the utility package .....	7- 18

<b>8 ONLINE MODULE CHANGE</b>	<b>8- 1 to 8- 13</b>
-------------------------------	----------------------

8.1 Online Module Change Conditions .....	8- 2
8.2 Online Module Change Operations .....	8- 3
8.3 Online Module Change Procedure .....	8- 4
8.3.1 GX Configurator-CT was used for initial setting .....	8- 4

8.3.2 Sequence program was used for initial setting .....	8- 8
8.4 Precautions for Online Module Change .....	8- 13

9 TROUBLESHOOTING	9- 1 to 9- 11
-------------------	---------------

9.1 Troubleshooting .....	9- 1
9.1.1 Confirming the error definitions using system monitor of GX Developer .....	9- 3
9.2 Error Details.....	9- 5
9.3 List of Errors .....	9- 8

APPENDICES	App - 1 to App - 2
------------	--------------------

Appendix 1 External Dimension Diagram .....	App - 1
---	---------

INDEX	Index - 1 to Index - 3
-------	------------------------

## USING THIS MANUAL

### ■ Manual Makeup

- (1) To know the features and overview of this product (Chapter 1)  
Section 1.1 gives the overview and Section 1.2 the features.
- (2) To know the system configuration (Chapter 2)  
Chapter 2 describes the system configuration, usable programmable controller CPUs, etc.
- (3) To know the system performance and function list (Chapter 3)  
Sections 3.1 to 3.4 provides the performance specifications, list of functions, I/O signals and list of buffer memory. Section 3.5 describes the interface with external devices.
- (4) To know the module installation and setting (Chapter 4)  
Chapter 4 describes the wiring example of the module and the setting method necessary for start of operation.
- (5) To know the functions and their setting methods (Chapter 5)  
Chapter 5 provides the functions and their setting methods.
- (6) To perform initial setting, etc. from the optional utility package (Chapter 6)  
Chapter 6 gives the method for operating the utility package.
- (7) To know the example of operating the QD60P8-G using a sequence program (Chapter 7)  
Chapter 7 provides a sequence program example.
- (8) To change the module without stopping the system (Chapter 8)  
Chapter 8 provides the method for changing the module without stopping the system (online module change).
- (9) To know Error code and corresponding remedy when an error occurs in the module (Chapter 9)  
Chapter 9 provides the troubleshooting and the error code list.

■ Numeric values used in this manual

- The buffer memory addresses and error codes are represented in decimal.
- The X/Y devices are represented in hexadecimal.
- The values read/written from/to the buffer memory and the values set using the intelligent function module switches are represented in either of decimal and hexadecimal. A hexadecimal value is ended by "H".  
 (Example) 10..... 10 Decimal  
           10H..... 16 Hexadecimal

COMPLIANCE WITH THE EMC AND LOW VOLTAGE DIRECTIVES

(1) For programmable controller system

To configure a system meeting the requirements of the EMC and Low Voltage Directives when incorporating the Mitsubishi programmable controller (EMC and Low Voltage Directives compliant) into other machinery or equipment, refer to Chapter 9 "EMC AND LOW VOLTAGE DIRECTIVES" of the QCPU User's Manual (Hardware Design, Maintenance and Inspection).

The CE mark, indicating compliance with the EMC and Low Voltage Directives, is printed on the rating plate of the programmable controller.

(2) For the product

For the compliance of this product with the EMC and Low Voltage Directives, refer to Section 4.4.1 "Wiring precautions".

GENERIC TERMS AND ABBREVIATIONS

Unless specially noted, the following generic terms and abbreviations are used in this manual.

Generic term/abbreviation	Details of generic term/abbreviation
QD60P8-G	Abbreviation for type QD60P8-G Channel Isolated Pulse Input Module.
Programmable controller CPU	Generic term for programmable controller CPU on which QD60P8-G can be mounted.
Personal computer	DOS/V-compatible personal computer of IBM PC/AT® or its compatible.
GX Developer	Product name for the MELSEC programmable controller software package.
GX Works2	
QCPU (Q mode)	Generic term for the Q00JCPU, Q00CPU, Q01CPU, Q02CPU, Q02HCPU, Q06HCPU, Q12HCPU, Q25HCPU, Q02PHCPU, Q06PHCPU, Q00UJCPU, Q00UCPU, Q01UCPU, Q12PHCPU, Q25PHCPU, Q12PRHCPU, Q25PRHCPU, Q02UCPU, Q03UDCPU, Q04UDHCPU, Q06UDHCPU, Q10UDHCPU, Q13UDHCPU, Q20UDHCPU, Q26UDHCPU, Q03UDECPU, Q04UDEHCPU, Q06UDEHCPU, Q10UDEHCPU, Q13UDEHCPU, Q20UDEHCPU, Q26UDEHCPU, Q20UDEHCPU and Q100UDEHCPU.
Process CPU	Generic term for Q02PHCPU, Q06PHCPU, Q12PHCPU, Q25PHCPU.
Redundant CPU	Generic term for the Q12PRHCPU and Q25PRHCPU.
GX Configurator-CT	Abbreviation for counter module setting/monitoring tool GX Configurator-CT (SW0D5C-QCTU-E).
Windows Vista®	Generic term for the following: Microsoft® Windows Vista® Home Basic Operating System, Microsoft® Windows Vista® Home Premium Operating System, Microsoft® Windows Vista® Business Operating System, Microsoft® Windows Vista® Ultimate Operating System, Microsoft® Windows Vista® Enterprise Operating System
Windows® XP	Generic term for the following: Microsoft® Windows® XP Professional Operating System, Microsoft® Windows® XP Home Edition Operating System

COMPONENT LIST

The component list of this product is given below.

Type	Component	Quantity
QD60P8-G	Type QD60P8-G Channel Isolated Pulse Input Module	1
SW0D5C-QCTU-E	GX Configurator-CT Version 1 (1-license product) (CD-ROM)	1
SW0D5C-QCTU-EA	GX Configurator-CT Version 1 (Volume-license product) (CD-ROM)	1





## CHAPTER 1 OVERVIEW

## 1.1 Overview

This User's Manual describes the specifications, handling, wiring and programming methods of the Channel Isolated Pulse Input Module (QD60P8-G) used with the MELSEC-Q series programmable controller CPU.

The QD60P8-G counts the input pulse number (speed, rotation speed, instant flux or similar) and measures the quantity the length, accumulating flux and so forth. Input pulse value is updated every 10ms. The QD60P8-G updates Accumulating count value and the pulse number after movement averaging processing or similar (Sampling pulse number) at intervals of Count cycle setting value.

## 1.2 Features

## (1) Wide range of functions

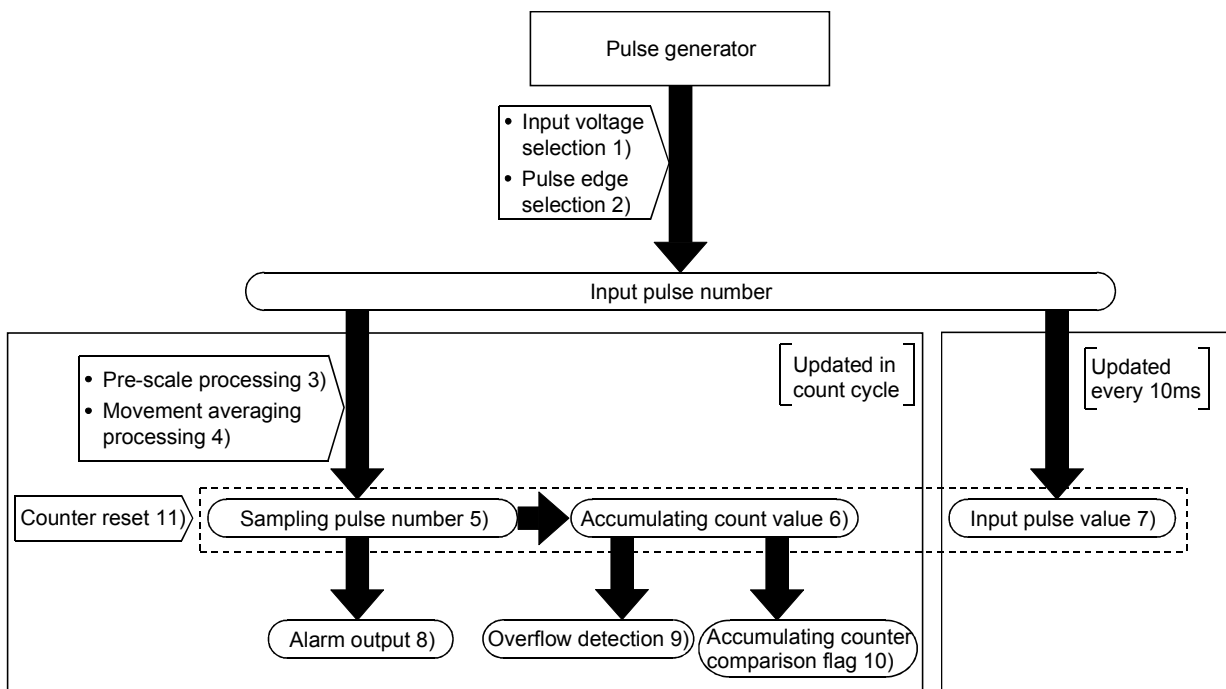

- 1) **Pulse input voltage**  
A single module accepts the pulse inputs of 5VDC/12 to 24VDC.
- 2) **Pulse edge selection**  
It is allowed to select the rise or fall of the input pulses to be counted.
- 3) **Pre-scale function**  
The input pulse number is multiplied by any value to convert the pulse number.
- 4) **Movement averaging function**  
The values of Sampling pulse number are averaged by the specified number of times to calculate the average value.

- 5) **Sampling pulse number indication**

The value obtained by performing pre-scale conversion on the pulse number entered in Count cycle setting value to the count cycle setting value is displayed. If the input pulse number is not uniform, movement averaging processing can be performed to average the input pulse number. The count range is 0 to 32767.
  - 6) **Accumulating count value indication**

The accumulating value of Sampling pulse number is displayed in the set count cycle. The count range is 0 to 99999999, and you can select whether to use the accumulating counter as the linear counter or ring counter.
  - 7) **Input pulse value indication**

The pulse number actually input is displayed every 10ms. Since the input pulse number is displayed every 10ms, the module can be used as a counter. (Input pulse value is updated every 10ms. Note this when using the module as a counter.) The count range is 0 to 2147483647.
  - 8) **Alarm output**

It is allowed to set four setting values, i.e. upper/upper limit value, upper/lower limit value, lower/upper limit value and lower/lower limit value, for Sampling pulse number to output alarms.
  - 9) **Accumulating counter overflow detection**

If Accumulating count value overflows (exceed 99999999) in the linear counter mode, the accumulating counter overflow detection flag turns on to indicate that an overflow error has occurred.
  - 10) **Accumulating counter comparison output**

If Accumulating count value reaches or exceeds Comparison output setting value, the accumulating counter comparison flag turns on.
  - 11) **Counter reset**

Sampling pulse number, Accumulating count value, and Input pulse value can be reset at any timing.
- (2) **Counting speed range of the input pulse can be changed**

By changing the input filter, the input pulse speed is available within the range 0 to 30kpps.
  - (3) **8 channels of pulse inputs in one module**

One module has 8 channels of pulse inputs to configure a system at low costs.
  - (4) **Channel isolated**

The channels are isolated from each other. (Dielectric withstand voltage: 1780VAC for 1 minute)

(5) Online module change

It is possible to change the module without stopping the system.

(6) Easy settings with GX Configurator-CT

The number of sequence programs can be reduced since GX Configurator-CT (sold separately) allows the channel isolated pulse input module settings on the dialog box.

Also, GX Configurator-CT simplifies the checking of the module settings and operation status.



CHAPTER 2 SYSTEM CONFIGURATION

This chapter explains the system configuration of the QD60P8-G.

2.1 Applicable Systems

This section describes the applicable systems.

(1) Applicable modules and base units, and No. of modules

(a) When mounted with a CPU module

The table below shows the CPU modules and base units applicable to the QD60P8-G and quantities for each CPU model.

Depending on the combination with other modules or the number of mounted modules, power supply capacity may be insufficient.

Pay attention to the power supply capacity before mounting modules, and if the power supply capacity is insufficient, change the combination of the modules.

Applicable CPU module		No. of modules *1	Base unit *2		
CPU type	CPU model		Main base unit	Extension base unit	
Programmable controller CPU	Basic model QCPU	Q00JCPU	○	○	
		Q00CPU			
		Q01CPU			
	High Performance model QCPU	Q02CPU	Up to 64	○	○
		Q02HCPU			
		Q06HCPU			
		Q12HCPU			
		Q25HCPU			
	Process CPU	Q02PHCPU	Up to 64	○	○
		Q06PHCPU			
		Q12PHCPU			
		Q25PHCPU			
	Redundant CPU	Q12PRHCPU	Up to 53 *3	×	○
		Q25PRHCPU			
	Universal model QCPU	Q00UJCPU	Up to 8	○	○
		Q00UCPU	Up to 24		
		Q01UCPU	Up to 36		
		Q02UCPU	Up to 64		
		Q03UDCPU			
		Q04UDHCPU			
Q06UDHCPU					
Q10UDHCPU					
Q13UDHCPU					
Q20UDHCPU					
Q26UDHCPU					

○: Applicable, ×: N/A

Applicable CPU module		No. of modules *1	Base unit *2	
CPU type	CPU model		Main base unit	Extension base unit
Programmable controller CPU	Universal model QCPU	Q03UDECPU	○	○
		Q04UDEHCPU		
		Q06UDEHCPU		
		Q10UDEHCPU		
		Q13UDEHCPU		
		Q20UDEHCPU		
		Q26UDEHCPU		
		Q50UDEHCPU		
	Q100UDEHCPU	N/A	×	×*4
Safety CPU	QS001CPU			
C Controller module	Q06CCPU-V	Up to 64	○	○
	Q06CCPU-V-B			
	Q12DCCPU-V			

○: Applicable, ×: N/A

\*1: Limited within the range of I/O points for the CPU module.

\*2: Can be installed to any I/O slot of a base unit.

\*3: Use the QD60P8-G module whose serial No. (first five digits) is 09012 or later.

\*4: The safety CPU cannot be connected with extension base units.

**REMARK**

For the use of the C Controller module, refer to C Controller Module User's Manual.

(b) Mounting to a MELSECNET/H remote I/O station

The table below shows the network modules and base units applicable to the QD60P8-G and quantities for each network module model.

Depending on the combination with other modules or the number of mounted modules, power supply capacity may be insufficient.

Pay attention to the power supply capacity before mounting modules, and if the power supply capacity is insufficient, change the combination of the modules.

Applicable network module	No. of modules *1	Base unit *2	
		Main base unit of remote I/O station	Extension base unit of remote I/O station
QJ72LP25-25	Up to 64	○	○
QJ72LP25G			
QJ72LP25GE			
QJ72BR15			

○: Applicable, ×: N/A

\*1: Limited within the range of I/O points for the network module.

\*2: Can be installed to any I/O slot of a base unit.

**REMARK**

The Basic model QCPU or C Controller module cannot create the MELSECNET/H remote I/O network.

(2) Support of the multiple CPU system

When using the QD60P8-G in a multiple CPU system, refer to the following manual first.

- QCPU User's Manual (Multiple CPU System)

(a) Supported QD60P8-G

The function version of the QD60P8-G has been "C" from the first release, supporting the multiple CPU system.

(b) Intelligent function module parameters

Write intelligent function module parameters only to the control CPU of the QD60P8-G.

(3) Support of online module change

The function version of the QD60P8-G has been "C" from the first release, supporting online module change.

For details, refer to CHAPTER 8.

(4) Supported software packages

Relation between the system containing the QD60P8-G and software package is shown in the following table.

GX Developer is necessary when using the QD60P8-G.

		Software Version												
		GX Developer	GX Configurator-CT	GX Works2										
Q00J/Q00/Q01CPU	Single CPU system	Version 7 or later	Version 1.14Q or later	Version 1.10N or later										
	Multiple CPU system	Version 8 or later												
Q02/Q02H/Q06H/ Q12H/Q25HCPU	Single CPU system	Version 4 or later		Version 1.14Q or later	Version 1.08J or later									
	Multiple CPU system	Version 6 or later												
Q02PH/Q06PHCPU	Single CPU system	Version 8.68W or later			Version 1.14Q or later	Not supported								
	Multiple CPU system													
Q12PH/Q25PHCPU	Single CPU system	Version 7.10L or later	Version 1.14Q or later				Not supported							
	Multiple CPU system													
Q12PRH/Q25PRHCPU	Redundant system	Version 8.45X or later		Version 1.16S or later										
Q00UJ/Q00U/ Q01UCPU	Single CPU system	Version 8.78G or later		Version 1.25AB or later				Version 1.08J or later						
	Multiple CPU system													
Q02U/Q03UD/Q04UDH/ Q06UDHCPU	Single CPU system	Version 8.48A or later			Version 1.25AB or later	Version 1.08J or later								
	Multiple CPU system													
Q10UDH/Q20UDHCPU	Single CPU system	Version 8.78G or later	Version 1.25AB or later				Version 1.08J or later							
	Multiple CPU system													
Q13UDH/Q26UDHCPU	Single CPU system	Version 8.62Q or later							Version 1.25AB or later	Version 1.08J or later				
	Multiple CPU system													
Q03UDE/Q04UDEH/ Q06UDEH/Q13UDEH/ Q26UDEHCPU	Single CPU system	Version 8.68W or later									Version 1.25AB or later	Version 1.08J or later		
	Multiple CPU system													
Q10UDEH/Q20UDEHCPU	Single CPU system	Version 8.78G or later											Version 1.25AB or later	Version 1.08J or later
	Multiple CPU system													
Q50UDEH/Q100UDEHCPU	Single CPU system	Not supported		Not supported				Version 1.31H or later						
	Multiple CPU system													
If installed in a MELSECNET/H remote I/O station		Version 6 or later		Version 1.14Q or later	Not supported									

**POINT**

Depending on the version of GX Configurator-CT, CPU modules and functions of the QD60P8-G vary.



## 2.2 Using the QD60P8-G with the Redundant CPU

The following describes the use of the QD60P8-G with Redundant CPU.

## (1) GX Configurator-CT

GX Configurator-CT cannot be used when accessing the Redundant CPU via an intelligent function module on the extension base unit from GX Developer. Connect a personal computer to the Redundant CPU with a communication path indicated below.

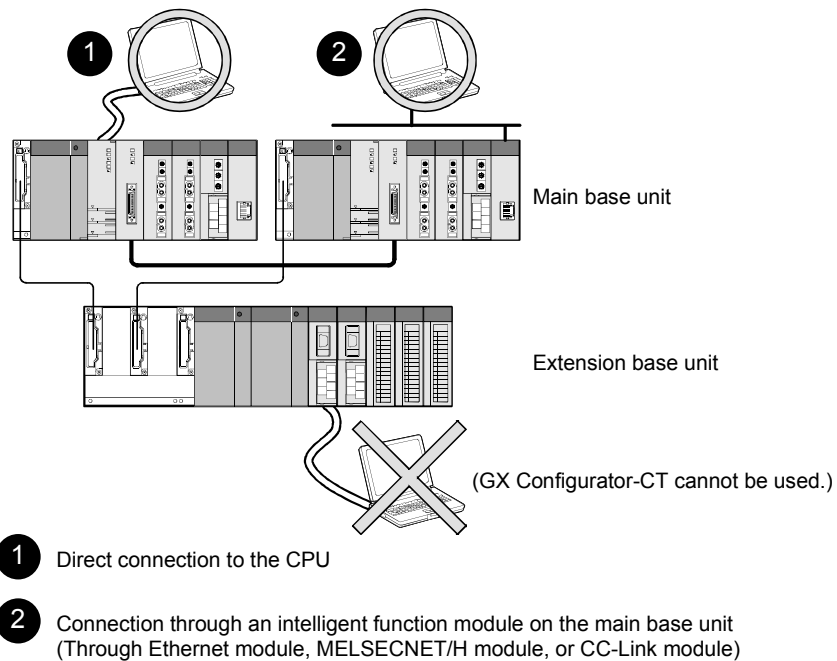

2.3 Checking Function Version, Serial Number, and Software Version

- (1) Checking the function version and serial number of the QD60P8-G  
 The serial number and function version of the QD60P8-G are described on the rating plate, on the front of the module, or displayed in the System monitor of GX Developer.

- (a) Checking the rating plate on the side of the QD60P8-G

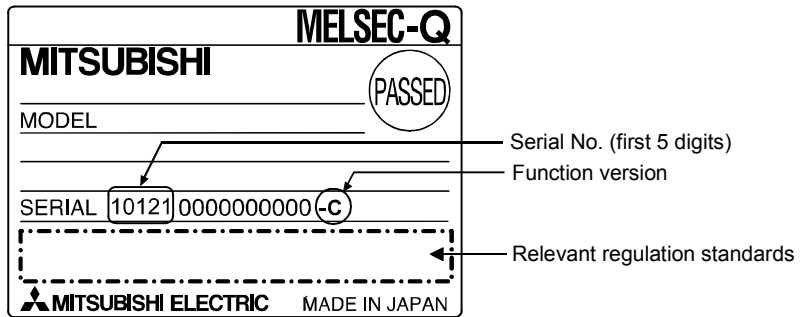

- (b) Checking the front of the module  
 The serial number and function version on the rating plate is shown on the front (at the bottom) of the module.

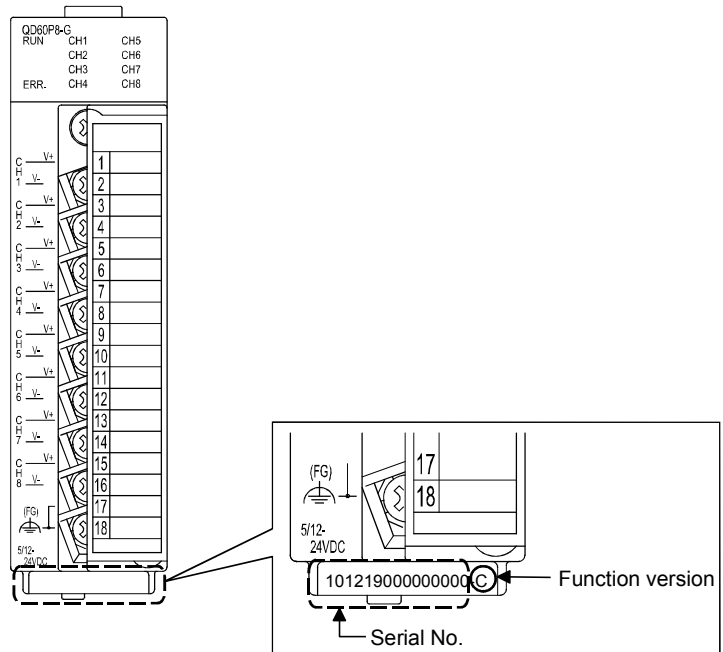

**REMARK**

The serial number is displayed on the front of the module from December 2008 production. Products manufactured during the switching period may not have the serial number on the front of the module.

(c) Checking the System monitor (Product Information List)

To display the System monitor, select [Diagnostics] → [System monitor] and click the **Product Information List** button of GX Developer.

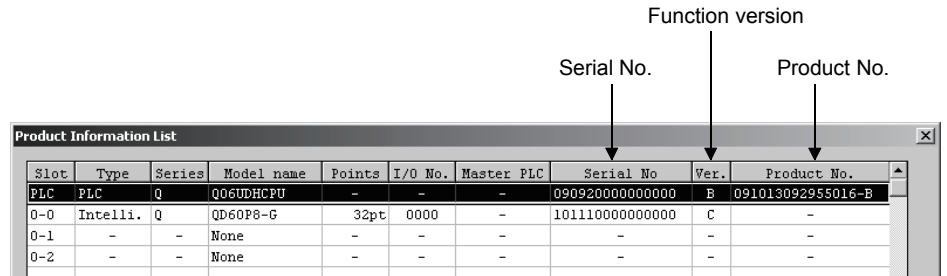

1) Displaying the product number.

Since the QD60P8-G does not support the display function, "-" is displayed in the "Product No." field.

**POINT**

The serial number displayed in the Product Information List dialog box of GX Developer may differ from that on the rating plate and on the front of the module.

- The serial number on the rating plate and front part of the module indicates the management information of the product.
- The serial number displayed in the Product Information List dialog box of GX Developer indicates the function information of the product.

The function information of the product is updated when a new function is added.

(2) Checking the software version of GX Configurator-CT

The software version of GX Configurator-CT can be checked by selecting [Help] → [Product information] of GX Developer.

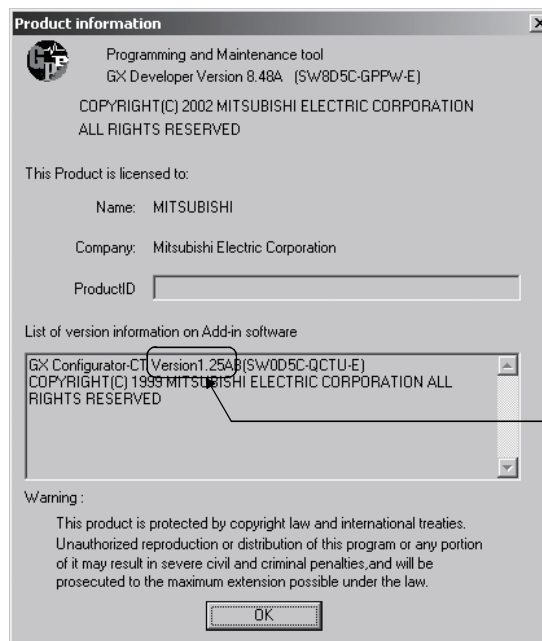

Software version

CHAPTER 3 SPECIFICATIONS

This chapter explains the performance specifications of the QD60P8-G, the I/O signals for the programmable controller CPU, and the specifications of the buffer memory. For the general specifications of the QD60P8-G, refer to the User's Manual of the used CPU module.

3.1 Performance Specifications

The following table indicates the performance specifications of the QD60P8-G.

Model name		QD60P8-G							
Item									
Counting speed switch settings*1		30kpps	10kpps	1kpps	100pps	50pps	10pps	1pps	0.1pps
Number of I/O occupied points		32 points (I/O assignment: 32 points for intelligent function module)							
Number of channels		8 channels							
Count input signal	Phase	1-phase input							
	Signal level	5VDC/12 to 24VDC							
Input derating		Refer to the derating chart (Next page)							
Counter	Counting speed (Max.) *2	30kpps	10kpps	1kpps	100pps	50pps	10pps	1pps	0.1pps
	Counting range	Sampling pulse number : 16-bit binary (0 to 32767) Accumulating count value : 32-bit binary (0 to 99999999) Input pulse value : 32-bit binary (0 to 2147483647)							
	Count type	Linear counter method, ring counter method							
	Minimum count pulse width (Duty ratio 50%)								
Dielectric withstand voltage		For 1 min at 1500VAC between AC external connecting terminals and general grounding For 1 min at 500VAC between DC external connecting terminals and general grounding For 1 min at 1780VAC between channels							
Insulation resistance		5MΩ or more at 500VDC between AC external connecting terminals and general grounding							
Connected terminal		18 points terminal block							
Applicable wire size		0.3 to 0.75mm <sup>2</sup>							
Applicable solderless terminals		R1.25-3 (A solderless terminals with sleeves cannot be used.)							
Internal current consumption (5VDC)		0.58A							
Weight		0.17kg							
External dimensions		27.4 (1.08) (W) X 98 (3.86) (H) X 90 (3.54) (D) [mm (in.)]							

\*1: To change the counting speed, use the intelligent function module switch. (For details, refer to "Section 4.5.2 Switch setting for intelligent function module".)  
 \*2: The counting speed is affected by the rise/fall time of pulses. The countable counting speeds are indicated in the table on the next page. Note that counting the pulses of long rise/fall time may result in miscounting.

<Rise/Fall time and the corresponding counting speed switch settings>

Rise/Fall Time	Counting speed switch settings							
	30kpps	10kpps	1kpps	100pps	50pps	10pps	1pps	0.1pps
t = 8.4μs or less	30kpps	10kpps	1kpps	100pps	50pps	10pps	1pps	0.1pps
t = 25μs or less	10kpps	10kpps	1kpps	100pps	50pps	10pps	1pps	0.1pps
t = 250μs or less	-	1kpps	1kpps	100pps	50pps	10pps	1pps	0.1pps
t = 2.5ms or less	-	-	100pps	100pps	50pps	10pps	1pps	0.1pps
t = 5ms or less	-	-	-	50pps	50pps	10pps	1pps	0.1pps
t = 25ms or less	-	-	-	-	10pps	10pps	1pps	0.1pps
t = 250ms or less	-	-	-	-	-	1pps	1pps	0.1pps
t = 2.5s or less	-	-	-	-	-	-	0.1pps	0.1pps
t = 5s	-	-	-	-	-	-	-	0.05pps

3

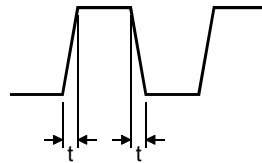

<Derating Chart>

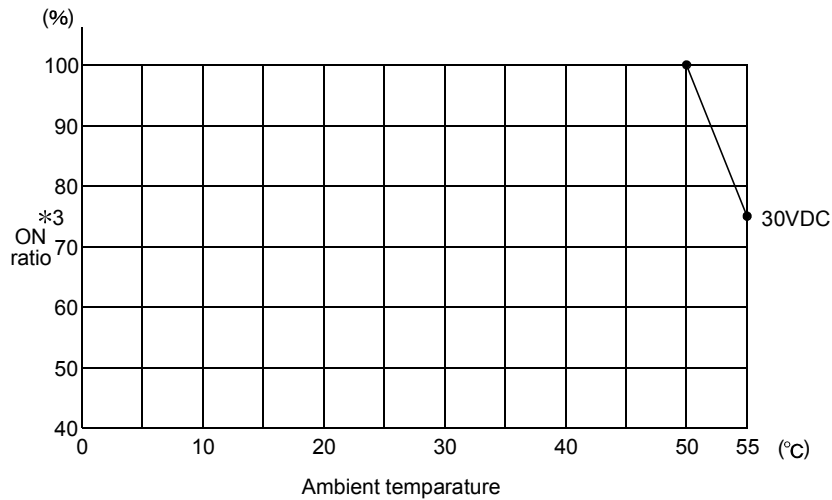

\*3: "ON" indicates the status where voltage is applied to pulse input terminals.

3.2 List of Functions

The following table indicates the QD60P8-G functions.

Name		Details	Reference
Accumulating counter	Linear counter function	This function counts from 0 to 99999999 and detects an overflow when the count range is exceeded.	Section 5.2.1
	Ring counter function	This function repeats counting between 0 and 99999999.	Section 5.2.2
	Comparison output function	This function turns on Accumulating counter comparison flag (X0 to X17) when Accumulating count value reaches or exceeds Comparison output setting value. (Accumulating counter comparison flag (X0 to X17) turns off by Comparison signal reset request (Y10 to Y17).)	Section 5.4
Sampling counter	Count cycle change function	This function changes the count cycle of Sampling pulse number or Accumulating count value.	Section 5.1.4
	Movement averaging function	This function performs movement averaging processing by the specified number of times if there are variations in Sampling pulse number.	Section 5.7
	Pre-scale function	This function converts the number of pulses by multiplying the number of input pulses by any setting number.	Section 5.6
	Alarm output function	This function sets the upper/upper limit value, upper/lower limit value, lower/upper limit value and lower/lower limit value for Sampling pulse number converted by the pre-scale function to output alarms.	Section 5.8
Counter reset function		This function resets Sampling pulse number, Accumulating count value, or Input pulse value. A reset can be made at any timing.	Section 5.5
Pulse edge selection function		This function selects whether the rise or fall of an input pulse will be used for counting. (This setting can be made for each channel using the intelligent function module switch.)	Section 4.5.2
Count enable function		This function starts input pulse count operation when Count enable (Y18 to Y1F) is turned on.	Section 5.1.2
Online module change function		This function changes the module without stopping the system. (Perform an online module change according to the messages of GX Developer.)	Chapter 8
Utility function		This function uses the utility package (GX Configurator-CT) to perform initial setting, auto refresh setting, monitor/test or similar from within the software without using sequence programs.	Chapter 6

<b>POINT</b>
<p>The above functions can be used in combination.                  However, the linear counter function and ring counter function cannot be used together.                  Please select either of them.</p>

3.3 I/O signals for Programmable Controller CPU

3.3.1 List of I/O signals

The following table indicates the I/O signals of the QD60P8-G for the programmable controller CPU.

The I/O numbers (X/Y) and I/O addresses indicated in this chapter and later assume that the QD60P8-G is installed on the I/O slot No. 0 of the main base unit.

Input signal (Signal direction: QD60P8-G → programmable controller CPU)			Output signal (Signal direction: programmable controller CPU → QD60P8-G)		
Device No.	Signal name		Device No.	Signal name	
X0	Module READY		Y0	Reserved (N/A) *	
X1	Operating condition setting complete flag		Y1	Operating condition setting request flag	
X2 to X7	Reserved (N/A) *		Y2 to Y7	Reserved (N/A) *	
X8	CH1	Error occurrence	Y8	CH1	Error reset request
X9	CH2		Y9	CH2	
XA	CH3		YA	CH3	
XB	CH4		YB	CH4	
XC	CH5		YC	CH5	
XD	CH6		YD	CH6	
XE	CH7		YE	CH7	
XF	CH8		YF	CH8	
X10	CH1	Accumulating counter comparison flag	Y10	CH1	Comparison signal reset request
X11	CH2		Y11	CH2	
X12	CH3		Y12	CH3	
X13	CH4		Y13	CH4	
X14	CH5		Y14	CH5	
X15	CH6		Y15	CH6	
X16	CH7		Y16	CH7	
X17	CH8		Y17	CH8	
X18 to X1F	Reserved (N/A) *		Y18	CH1	Count enable
			Y19	CH2	
			Y1A	CH3	
			Y1B	CH4	
			Y1C	CH5	
			Y1D	CH6	
			Y1E	CH7	
			Y1F	CH8	

\*: Write is inhibited to the I/O (X/Y) reserved for the system.

3.3.2 Details of I/O signals

The I/O signals of the QD60P8-G are detailed below.

(1) Details of input signals (QD60P8-G → programmable controller CPU)

The following table indicates the on/off timings and functions of the input signals.

Device No.	Signal name		Details	Initial value *1
X0	Module READY		<ul style="list-style-type: none"> <li>• This signal judges whether the QD60P8-G is normal or abnormal in the sequence program. This signal turns on when the module starts normally at power-on or reset operation.</li> <li>• This signal turns off at occurrence of a watch dog timer error.</li> </ul>	OFF
X1	Operating condition setting completed flag		<ul style="list-style-type: none"> <li>• This signal is used as an interlock for turning on/off Operating condition setting request flag (Y1) when the function, such as the comparison output function, is selected or the setting value is changed.</li> <li>• When this signal is off, input pulses are not counted.</li> <li>• After confirming that the operating condition setting is completed (this signal has turned on), turn on Count enable (Y18 to Y1F) to start pulse counting.</li> </ul> <p>Module READY (X0)</p> <p>Operating condition setting completed flag (X1)</p> <p>Operating condition setting request flag (Y1)</p> <p>Count enable (Y18 to Y1F)</p>	OFF
X8	CH1	Error occurrence	<ul style="list-style-type: none"> <li>• This signal turns on if an error exists in the overflow detection or initial setting data. (The details of the error can be confirmed from the "system monitor" screen of GX Developer.)</li> <li>• This signal turns off when Error reset request (Y8 to YF) is turned on.</li> <li>• "Error code" is stored into the buffer memory of the corresponding channel (refer to Section 3.4.2 for details).</li> </ul> <p>Error occurrence (X8 to XF)</p> <p>Error reset request (Y8 to YF)</p> <p>Error code is read during this period.</p>	OFF
X9	CH2			
XA	CH3			
XB	CH4			
XC	CH5			
XD	CH6			
XE	CH7			
XF	CH8			

\*1: Initial value set at power-on or when the programmable controller CPU is reset.



Device No.	Signal name		Details	Initial value *1
X10	CH1	Accumulating counter comparison flag	<ul style="list-style-type: none"> <li>• This signal turns on if "Accumulating count value" reaches or exceeds "Comparison output setting value". "Accumulating count value" is stored into the buffer memory for each channel. Set "Comparison output setting value" to the buffer memory for each channel. (Refer to Section 3.4.2 for details.)</li> <li>• This signal remains on until Comparison signal reset request (Y10 to Y17) turns on.</li> <li>• Once turned off, this signal does not turn on until Accumulating count value reaches Comparison output setting value again after it has been reset.</li> </ul> <p>                     -----&gt; Executed by QD60P8-G                      -----&gt; Executed by sequence program                 </p> <p>                     Accumulating count value                      Comparison output setting value                      Accumulating counter comparison flag (X10 to X17)                      Comparison signal reset request (Y10 to Y17)                 </p>	OFF
X11	CH2			
X12	CH3			
X13	CH4			
X14	CH5			
X15	CH6			
X16	CH7			
X17	CH8			

\*1: Initial value set at power-on or when the programmable controller CPU is reset.

(2) Details of output signals (programmable controller CPU → QD60P8-G)

The following table indicates the on/off timings and functions of the output signals.

Device No.	Signal name		Details	Initial value *1
Y1	Operating condition setting request flag		OFF: No operating condition setting request ON : Operating condition setting request	OFF
Y8	CH1	Error reset request	OFF: No Error reset request ON : Error reset request	OFF
Y9	CH2			
YA	CH3			
YB	CH4			
YC	CH5			
YD	CH6			
YE	CH7			
YF	CH8			
Y10	CH1	Comparison signal reset request	OFF: No Comparison signal reset request ON : Comparison signal reset request	OFF
Y11	CH2			
Y12	CH3			
Y13	CH4			
Y14	CH5			
Y15	CH6			
Y16	CH7			
Y17	CH8			
Y18	CH1	Count enable	OFF: Count operation stop ON : Count operation start	OFF
Y19	CH2			
Y1A	CH3			
Y1B	CH4			
Y1C	CH5			
Y1D	CH6			
Y1E	CH7			
Y1F	CH8			

\*1: Initial value set at power-on or when the programmable controller CPU is reset.

3.4 Buffer Memory

3.4.1 List of buffer memory assignments

The following table indicates the assignment of the QD60P8-G buffer memory. Refer to Section 3.4.2 for details of the buffer memory areas.

The initial values are set to the buffer memory at power-on or when the programmable controller CPU is reset. (When power is turned off, the setting values in the buffer memory are not retained.)

The sequence program or programmable controller CPU's auto refresh function, reads/writes the buffer memory contents.

The settings are reflected on the module by turning on Operating condition setting request flag (Y1) after the data have been written to the buffer memory.

Buffer memory address								Setting details	Initial value	Read/Write
CH1	CH2	CH3	CH4	CH5	CH6	CH7	CH8			
0	32	64	96	128	160	192	224	Sampling pulse number	0	Read only
1	33	65	97	129	161	193	225	Comparison output selection		Read/Write enabled
2	34	66	98	130	162	194	226	Comparison output setting value		
3	35	67	99	131	163	195	227			(H)
4	36	68	100	132	164	196	228	Movement averaging processing selection		Read only
5	37	69	101	133	165	197	229	Number of movement averaging processing		
6	38	70	102	134	166	198	230	Pre-scale function selection		
7	39	71	103	135	167	199	231	Pre-scale setting value		
8	40	72	104	136	168	200	232	Accumulating count value		(L)
9	41	73	105	137	169	201	233			(H)
10	42	74	106	138	170	202	234	Input pulse value		(L)
11	43	75	107	139	171	203	235			(H)
12	44	76	108	140	172	204	236	Overflow detection flag		Read only
13	45	77	109	141	173	205	237	Counter reset request		
14	46	78	110	142	174	206	238	Carry over detection flag		Read only
15	47	79	111	143	175	207	239	Carry over reset request		Read/Write enabled
16	48	80	112	144	176	208	240	Error code		Read only
17	49	81	113	145	177	209	241	Alarm output selection		Read/Write enabled
18	50	82	114	146	178	210	242	Alarm output flag		Read only
19	51	83	115	147	179	211	243	Alarm output setting value upper/upper limit		Read/Write enabled
20	52	84	116	148	180	212	244	Alarm output setting value upper/lower limit		
21	53	85	117	149	181	213	245	Alarm output setting value lower/upper limit		
22	54	86	118	150	182	214	246	Alarm output setting value lower/lower limit		
23	55	87	119	151	183	215	247	Count cycle change function selection		
24	56	88	120	152	184	216	248	Count cycle setting value		Reserved (N/A)
25 to 31	57 to 63	89 to 95	121 to 127	153 to 159	185 to 191	217 to 223	249 to 255		—	

\*1: Initial value set at power-on or when the programmable controller CPU is reset.

3.4.2 Details of buffer memory

The following table indicates the functions and setting values of the buffer memory areas.

Item	Details	Initial value	Buffer memory address															
			CH1	CH2	CH3	CH4	CH5	CH6	CH7	CH8								
Sampling pulse number	<ul style="list-style-type: none"> <li>Stores the pulse number obtained by converting the input pulses into the unit pulse number using the pre-scale function.</li> <li>When Count enable (Y18 to Y1F) turns on, count operation starts. The count range is 0 to 32767.</li> <li>The update timing is the interval set in "Count cycle setting value" of the buffer memory. (The initial value of the count cycle is 1s.)</li> </ul>	0	0	32	64	96	128	160	192	224								
Comparison output selection	<ul style="list-style-type: none"> <li>Set whether the comparison output function is valid or invalid.</li> <li>If the setting value is other than 0 or 1, a comparison output setting range outside error (Error code: 200) occurs. To clear the error, turn on Error reset request (Y8 to YF) of the corresponding channel. After this, set a correct value and then turn on Operating condition setting request flag (Y1).</li> </ul> [Setting value] 0: Comparison output function invalid 1: Comparison output function valid	0	1	33	65	97	129	161	193	225								
Comparison output setting value	<ul style="list-style-type: none"> <li>Set the value to be compared with "Accumulating count value" of the buffer memory.</li> <li>If the setting value is outside the range, a comparison output setting range outside error (Error code: 200) occurs. To clear the error, turn on Error reset request (Y8 to YF) of the corresponding channel. After this, set a correct value and then turn on Operating condition setting request flag (Y1).</li> <li>The relationships between Accumulating count value, Comparison output setting value, and Accumulating counter comparison flag (X10 to X17) on/off are as indicated below.</li> </ul> <table border="1" style="margin-left: 20px;"> <thead> <tr> <th>Setting value and Accumulating count value</th> <th>Accumulating counter comparison flag (X10 to X17)</th> </tr> </thead> <tbody> <tr> <td>Setting value &gt; Accumulating count value</td> <td>OFF</td> </tr> <tr> <td>Setting value = Accumulating count value</td> <td>ON</td> </tr> <tr> <td>Setting value &lt; Accumulating count value</td> <td>ON</td> </tr> </tbody> </table> <ul style="list-style-type: none"> <li>Accumulating counter comparison flag (X10 to X17) is cleared by turning on Comparison signal reset request (Y10 to Y17) of the corresponding channel.</li> <li>When the accumulating counter is operating as a linear counter, Accumulating counter comparison flag (X10 to X17) that was turned off once does not turn on until the accumulating count value reaches Comparison output setting value again after it has been reset. When the accumulating counter is operating as a ring counter, the flag turns on when Accumulating count value reaches Comparison output setting value again in the ring processing.</li> </ul> [Setting range: 0 to 99999999]	Setting value and Accumulating count value	Accumulating counter comparison flag (X10 to X17)	Setting value > Accumulating count value	OFF	Setting value = Accumulating count value	ON	Setting value < Accumulating count value	ON	0	2 3	34 35	66 67	98 99	130 131	162 163	194 195	226 227
Setting value and Accumulating count value	Accumulating counter comparison flag (X10 to X17)																	
Setting value > Accumulating count value	OFF																	
Setting value = Accumulating count value	ON																	
Setting value < Accumulating count value	ON																	

\*: Refer to Section 9.3 for details of the error codes.

Item	Details	Initial value	Buffer memory address																					
			CH1	CH2	CH3	CH4	CH5	CH6	CH7	CH8														
Movement averaging processing selection	<ul style="list-style-type: none"> <li>When "movement averaging processing" is set in Movement averaging processing selection, movement averaging processing is performed on "Sampling pulse number" of the buffer memory by the number of times set in "Number of movement averaging processing" of the buffer memory.</li> <li>When the setting value is other than 0 or 1, a movement averaging setting range outside error (Error code: 300) occurs. To clear the error, turn on Error reset request (Y8 to YF) of the corresponding channel. After this, set a correct value and then turn on Operating condition setting request flag (Y1).</li> </ul> [Setting value] 0: Sampling processing 1: Movement averaging processing	0	4	36	68	100	132	164	196	228														
Number of movement averaging processing	<ul style="list-style-type: none"> <li>Set the number of times to perform movement averaging processing on "Sampling pulse number" of the buffer memory.</li> <li>When "movement averaging processing" is selected in "Movement averaging processing selection" of the buffer memory, the initial value of this buffer memory is "0". Therefore, if you run the programmable controller CPU without setting the value, a movement averaging setting range outside error (Error code: 300) will occur.</li> <li>If the setting value is outside the range, a movement averaging setting range outside error (Error code: 300) occurs. To clear the error, turn on Error reset request (Y8 to YF) of the corresponding channel. After this, set a correct value and then turn on Operating condition setting request flag (Y1).</li> </ul> [Setting range: 2 to 60]	0	5	37	69	101	133	165	197	229														
Pre-scale function selection	<ul style="list-style-type: none"> <li>The pre-scale function converts the input pulse number per count cycle into the unit pulse number when the weight per pulse is a fraction, and stores the result of conversion into "Sampling pulse number" of the buffer memory. The following operation formula is used at this time.                Sampling pulse number =                Input pulse value per count cycle × Pre-scale setting value × Unit magnification                The converted sampling pulse number is rounded down to the decimal point.</li> </ul> <table border="1" style="margin-left: 20px;"> <thead> <tr> <th>Pre-scale function selection (Unit magnification)</th> <th>Setting value</th> </tr> </thead> <tbody> <tr> <td>Pre-scale function invalid</td> <td>0</td> </tr> <tr> <td>× 1</td> <td>1</td> </tr> <tr> <td>× 0.1</td> <td>2</td> </tr> <tr> <td>× 0.01</td> <td>3</td> </tr> <tr> <td>× 0.001</td> <td>4</td> </tr> <tr> <td>× 0.0001</td> <td>5</td> </tr> </tbody> </table> <ul style="list-style-type: none"> <li>If the setting value is other than the above values, a pre-scale setting range outside error (Error code: 400) occurs. To clear the error, turn on Error reset request (Y8 to YF) of the corresponding channel. After this, set a correct value and then turn on Operating condition setting request flag (Y1).</li> </ul>	Pre-scale function selection (Unit magnification)	Setting value	Pre-scale function invalid	0	× 1	1	× 0.1	2	× 0.01	3	× 0.001	4	× 0.0001	5	0	6	38	70	102	134	166	198	230
Pre-scale function selection (Unit magnification)	Setting value																							
Pre-scale function invalid	0																							
× 1	1																							
× 0.1	2																							
× 0.01	3																							
× 0.001	4																							
× 0.0001	5																							

\*: Refer to Section 9.3 for details of Error code.

Item	Details	Initial value	Buffer memory address							
			CH1	CH2	CH3	CH4	CH5	CH6	CH7	CH8
Pre-scale setting value	<ul style="list-style-type: none"> <li>Set the pre-scale setting value.</li> <li>"Sampling pulse number" of the buffer memory with the following operation formula: Sampling pulse number = Input pulse value per count cycle × Pre-scale setting value × Unit magnification Note that if Pre-scale setting value is "0", the displayed sampling pulse number becomes 0 from the above operation formula, and therefore, it seems as if pulses are not counted although they are actually counted.</li> <li>If the setting value is outside the range, a pre-scale setting range outside error (Error code: 400) occurs. To clear the error, turn on Error reset request (Y8 to YF) of the corresponding channel. After this, set a correct value and then turn on Operating condition setting request flag (Y1). [Setting range: 0 to 32767]</li> </ul>	0	7	39	71	103	135	167	199	231
Accumulating count value	<ul style="list-style-type: none"> <li>Stores the accumulating value of "Sampling pulse number" of the buffer memory.</li> <li>The accumulating count value can be used when either the linear counter or ring counter is selected.</li> <li>The accumulating count range is 0 to 99999999 for both the linear counter and ring counter.</li> <li>If the accumulating count value exceeds 99999999 when the accumulating counter is used as the linear counter, "Overflow detection flag" of the buffer memory turns on.</li> <li>When Operating condition setting request flag (Y1) is turned on or "1" is set in "Counter reset request" of the buffer memory, the accumulating count value is reset.</li> <li>The update timing is the same as the cycle of Sampling pulse number. (It is the interval set in "Count cycle setting value" of the buffer memory.)</li> </ul>	0	8 9	40 41	72 73	104 105	136 137	168 169	200 201	232 233
Input pulse value	<ul style="list-style-type: none"> <li>Stores the actually entered pulse number.</li> <li>This value is not converted into the unit pulse number by the pre-scale function, unlike "Sampling pulse number" and "Accumulating count value" of the buffer memory.</li> <li>The count indication range is 0 to 2147483647.</li> <li>When Operating condition setting request flag (Y1) is turned on or "1" is set in "Counter reset request" of the buffer memory, Input pulse value is reset.</li> <li>If an overflow error (Error code: 100) occurs, this value is kept counted when Count enable (Y18 to Y1F) is on.</li> <li>The update timing is fixed at 10ms. Therefore, take care when using the module as a counter.</li> </ul>	0	10 11	42 43	74 75	106 107	138 139	170 171	202 203	234 235
Overflow detection flag	<ul style="list-style-type: none"> <li>If "Accumulating count value" of the buffer memory exceeds 99999999 when the accumulating counter is used as the linear counter, Overflow detection flag turns on. At the same time, an overflow error (Error code: 100) occurs and count operation is stopped.</li> <li>When the overflow error has occurred, Accumulating count value does not change from 99999999 if pulses are input after Error occurrence. "Sampling pulse number" of the buffer memory is reset.</li> <li>The overflow error is cleared by setting "1" in "Counter reset request" of the buffer memory. Count operation is resumed after the error is cleared.</li> <li>The error is also cleared by turning on Error reset request (Y8 to YF). To resume count operation, however, turn on Operating condition setting request flag (Y1) or set "1" in the counter reset request. [Detection value] 0: No overflow detection (OFF) 1: Overflow detection (ON)</li> </ul>	0	12	44	76	108	140	172	204	236

\*: Refer to Section 9.3 for details of Error code.

Item	Details	Initial value	Buffer memory address							
			CH1	CH2	CH3	CH4	CH5	CH6	CH7	CH8
Counter reset request	<ul style="list-style-type: none"> <li>Setting "1" in Counter reset request resets "Sampling pulse number", "Accumulating count value" or "Input pulse value" of the buffer memory.</li> <li>When a reset is made, the input pulses are invalid for a maximum of 20ms.</li> <li>If count operation has been stopped due to the detection of an overflow when the accumulating counter is used as the linear counter, the count operation is resumed after completion of a counter reset.</li> <li>If the setting value is other than 1, the setting is ignored.</li> </ul> [Setting value] 1: Reset request (The value automatically turns to "0" after completion of a counter reset.)	0	13	45	77	109	141	173	205	237
Carry over detection flag	<ul style="list-style-type: none"> <li>If the "Accumulating count value" of the buffer memory exceeds 99999999 when the accumulating counter is used as the ring counter, Carry over detection flag turns on.</li> <li>Unlike Overflow detection flag, count operation is continued.</li> <li>Carry over detection flag is reset by setting "1" in "Carry over reset request" of the buffer memory.</li> <li>Unlike the overflow detection flag, an error does not occur if Carry over detection flag turns on.</li> </ul> [Detection value] 0: No carry over detection (OFF) 1: Carry over detection (ON)	0	14	46	78	110	142	174	206	238
Carry over reset request	<ul style="list-style-type: none"> <li>Set Carry over reset request.</li> <li>If the setting value is other than 1, the setting is ignored.</li> </ul> [Setting value] 1: Reset request (The value automatically turns to "0" after completion of a carry over reset.)	0	15	47	79	111	143	175	207	239
Error code	<ul style="list-style-type: none"> <li>Stores Error code.</li> <li>The latest error code is always stored into Error code.</li> </ul>	0	16	48	80	112	144	176	208	240
Alarm output selection	<ul style="list-style-type: none"> <li>Set whether an alarm will be output or not for "Sampling pulse number" of the buffer memory.</li> <li>If the setting value is other than 0 or 1, an alarm output setting range outside error (Error code: 500) occurs.</li> </ul> [Setting value] 0: Alarm output function invalid 1: Alarm output function valid	0	17	49	81	113	145	177	209	241
Alarm output flag	<ul style="list-style-type: none"> <li>When "alarm output function valid" has been set in "Alarm output selection" of the buffer memory, Alarm output flag turns on if Sampling pulse number exceeds the upper/upper limit value or lower/lower limit value.</li> </ul> 	0	18	50	82	114	146	178	210	242

\*: Refer to Section 9.3 for details of Error codes.

Item	Details	Initial value	Buffer memory address							
			CH1	CH2	CH3	CH4	CH5	CH6	CH7	CH8
Alarm output setting value upper/upper limit	<ul style="list-style-type: none"> <li>Set the alarm output setting values (upper/upper limit, upper/lower limit, lower/upper limit, lower/lower limit).</li> <li>The following setting values can also be set: upper/upper limit = upper/lower limit, lower/upper limit = lower/lower limit. However, an alarm output setting range outside error (Error code: 500) occurs if the setting value is outside the setting range or the following relation expression is not established. Upper/upper limit <math>\geq</math> upper/lower limit &gt; lower/upper limit <math>\geq</math> lower/lower limit</li> <li>To clear the error, turn on Error reset request (Y8 to YF) of the corresponding channel.</li> <li>After this, set a correct value (value that will establish the above relation expression and is within the setting range), and then turn on Operating condition setting request flag (Y1).</li> </ul> [Setting range: 0 to 32767]	0	19	51	83	115	147	179	211	243
Alarm output setting value upper/lower limit			20	52	84	116	148	180	212	244
Alarm output setting value lower/upper limit			21	53	85	117	149	181	213	245
Alarm output setting value lower/lower limit			22	54	86	118	150	182	214	246
Count cycle change function selection	<ul style="list-style-type: none"> <li>Set whether the count cycle change function is valid or invalid.</li> <li>Set the count cycle in "Count cycle setting value" of the buffer memory.</li> <li>By setting "Count cycle change function selection valid", the update timing of "Sampling pulse number" or "Accumulating count value" of the buffer memory becomes the time set in "Count cycle setting value" of the buffer memory.</li> <li>When "Count cycle change function selection invalid" is set, the count cycle is fixed at 1s.</li> <li>If the setting value is other than 0 or 1, a count cycle setting range outside error (Error code: 600) occurs. To clear the error, turn on Error reset request (Y8 to YF) of the corresponding channel. After this, set a correct value and then turn on Operating condition setting request flag (Y1).</li> </ul> [Setting value] 0: Count cycle change function selection invalid 1: Count cycle change function selection valid	0	23	55	87	119	151	183	215	247
Count cycle setting value	<ul style="list-style-type: none"> <li>Set the count cycle of "Sampling pulse number" or "Accumulating count value" of the buffer memory.</li> <li>If the setting value is other than the following values, a count cycle setting range outside error (Error code: 600) occurs. To clear the error, turn on Error reset request (Y8 to YF) of the corresponding channel. After this, set a value within the setting range and then turn on Operating condition setting request flag (Y1).</li> </ul> [Setting value] 0: 1s 1: 100ms 2: 200ms 3: 500ms	0	24	56	88	120	152	184	216	248

\*: Refer to Section 9.3 for details of Error code.



3.5 Interface with External Devices

The internal circuit of the QD60P8-G interface for connection of external devices is shown in a schematic diagram.

Input/Output	Internal circuit	Terminal number	Signal name	Operation	Input voltage (guaranteed value)	Operating current (guaranteed value)
Input		1, 3, 5, 7, 9, 11, 13, 15	CH1 to 8 V+	At on	5VDC *	4mA or more
					12 to 24VDC *	4mA or more
		2, 4, 6, 8, 10, 12, 14, 16	CH1 to 8 V-	At off	5VDC *	0.5mA or less
					12 to 24VDC *	0.5mA or less
-	-	17, 18	FG	-	-	-

\*: Use the intelligent function module switch to change between 5VDC and 12 to 24VDC. (For details, refer to "Section 4.5.2 Switch setting for intelligent function module".)

Signal layout of each channel

	Terminal number	Signal name
CH1	1	CH1 V+
	2	CH1 V-
CH2	3	CH2 V+
	4	CH2 V-
CH3	5	CH3 V+
	6	CH3 V-
CH4	7	CH4 V+
	8	CH4 V-
CH5	9	CH5 V+
	10	CH5 V-
CH6	11	CH6 V+
	12	CH6 V-
CH7	13	CH7 V+
	14	CH7 V-
CH8	15	CH8 V+
	16	CH8 V-

## CHAPTER 4 SETUP AND PROCEDURE BEFORE OPERATION

The following describes the procedure prior to the QD60P8-G operation, the name and setting of each part of the QD60P8-G, and wiring method.

### 4.1 Handling Precautions

The following are the precautions for handling the QD60P8-G.

- (1) Do not drop the module casing, or do not subject it to strong impact.
- (2) Do not remove the PCB of each module from its case. Doing so may cause breakdowns.
- (3) Be careful not to let foreign matters such as sawdust or wire chips get inside the module. These may cause fires, failure and malfunction.
- (4) The top surface of the module is covered with a protective film to prevent foreign objects such as cable offcuts from entering the module when wiring. Do not remove this film until the wiring is complete.  
Before operating the system, be sure to remove the film to provide adequate heat ventilation.
- (5) Tighten the screws such as module fixing screws within the following ranges.

Screw location	Tightening torque range
Module fixing screw (M3 screw) *1	0.36 to 0.48N•m
Terminal block screw (M3 screw)	0.42 to 0.58N•m
Terminal block mounting screw (M3.5 screw)	0.66 to 0.89N•m

\*1: The module can be easily fixed onto the base unit using the hook at the top of the module.

However, it is recommended to secure the module with the module fixing screw if the module is subject to significant vibration.

- (6) To mount the module on the base unit, fully insert the module fixing latch into the fixing hole in the base unit and press the module using the hole as a fulcrum. Improper installation may result in a malfunction or breakdown of the module, or may cause the module to fall off.

4.2 Procedure before Operation

The figure below shows the steps that should be followed before starting the QD60P8-G operation.

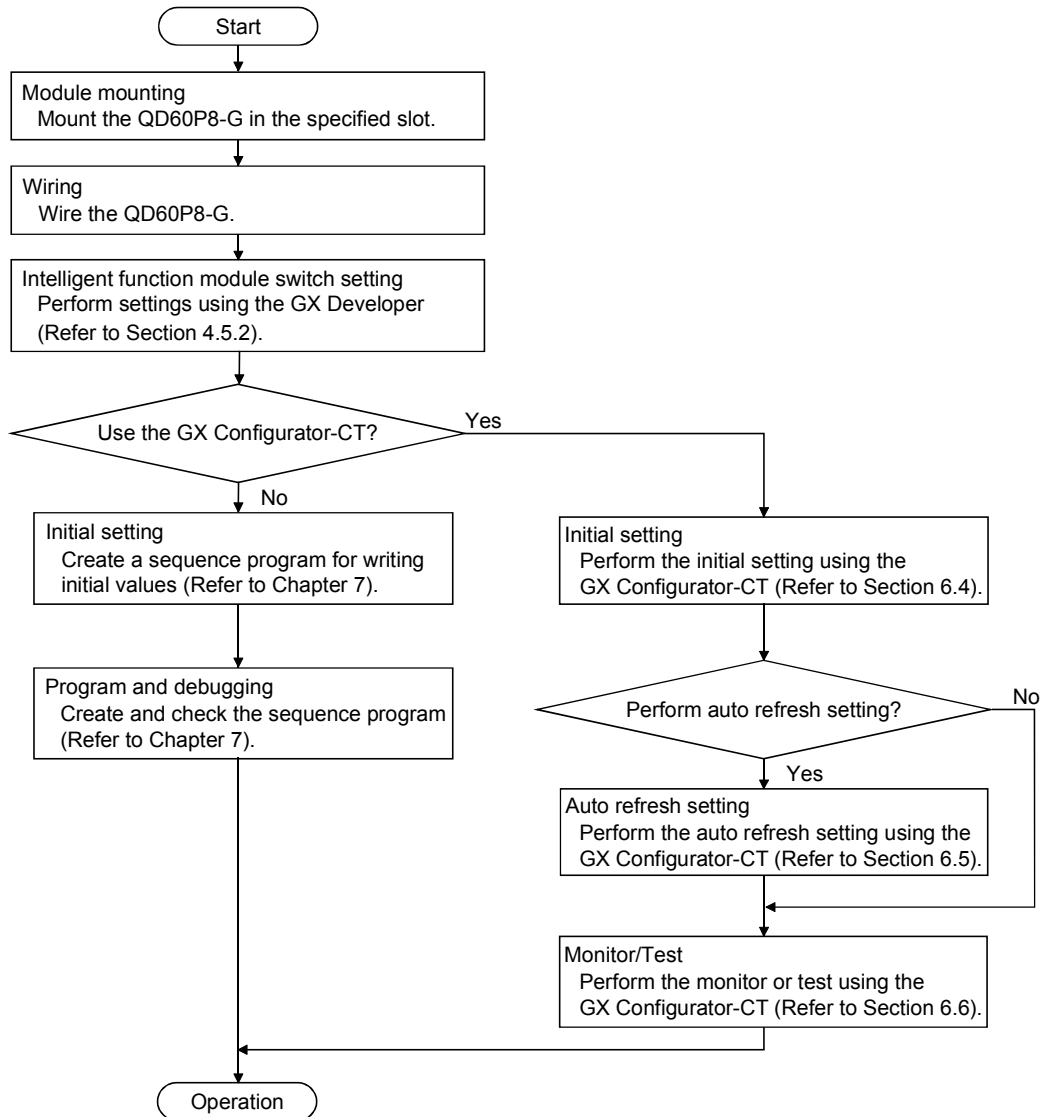

4.3 Part Identification Nomenclature

(1) Part identification nomenclature

The following are the part names of the QD60P8-G.

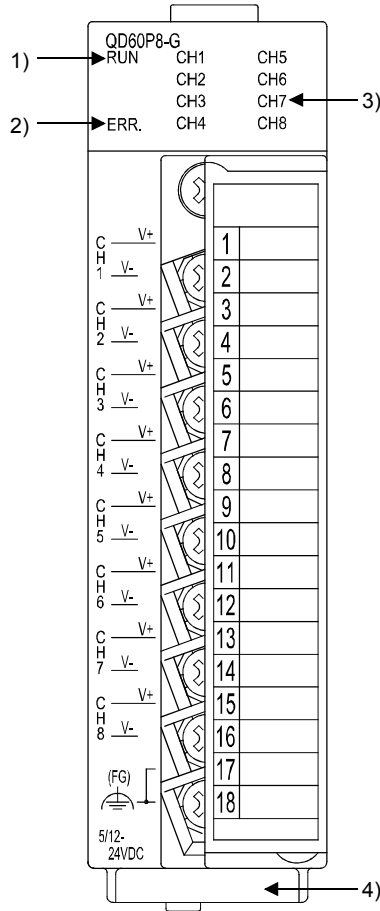

(2) LED display

The LEDs turn on/off as described below depending on the operating status of the module.

Number	Name	Details
1)	RUN LED	Indicates the operating status of the QD60P8-G. ON : Operating normally. OFF : 5V power is off, watch dog timer error occurred, in the module changeable status during online module change.
2)	ERR. LED	Indicates the error status of the QD60P8-G. ON : Error is occurring. OFF : Operating normally.
3)	CH1 to CH8 LED	Displays the voltage application status of the input terminals. ON : Voltage is being applied to the CH1 to CH8 pulse input terminal. OFF : No voltage applied to pulse input terminals of CH1 to CH8.

(3) Serial number plate

Number	Name	Details
4)	Serial number plate	Indicates the serial No. of the QD60P8-G.

## 4.4 Wiring

This section explains how to wire the pulse generator to the QD60P8-G. The following are the precautions for wiring the QD60P8-G. Read these precautions together with "Section 4.1 Handling precautions" to ensure work safety.

### 4.4.1 Wiring precautions

In order to fully utilise the functions of the QD60P8-G and ensure system reliability, external wiring having a minimum of noise effect must be provided.

The precautions regarding external wiring are described below.

- (1) Use separate cables with the AC control circuit and QD60P8-G's external input signals to avoid the influence of AC side surges and induction.
- (2) Do not run the cable close to, or bundle them with, the main circuit and high-voltage cables and the load cables from other than the programmable controller. Failure to do so will make the cables susceptible to noise, surges and induction.
- (3) If there may be the effect of noise when a cable to be connected to the QD60P8-G and the power line are installed close to each other, use a general shielded twisted pair cable as a countermeasure against noise. The shield must be grounded on the QD60P8-G side.
- (4) No solderless terminals with insulation sleeves can be used on the terminal block. It is recommended to cover the electric wire connecting section of each solderless terminal with a marking tube or insulating tube.
- (5) The cables connected to the QD60P8-G should be placed in a duct or fixed. Not doing so can cause the QD60P8-G or cables to be damaged when the cables swing, move or are pulled carelessly, for example, or to malfunction due to poor cable connection.

- (6) To comply with the EMC Directive and Low-Voltage Directive, always ground the QD60P8-G to the control box using shielded twisted pair cables and AD75CK cable clamping (Mitsubishi Electric make).

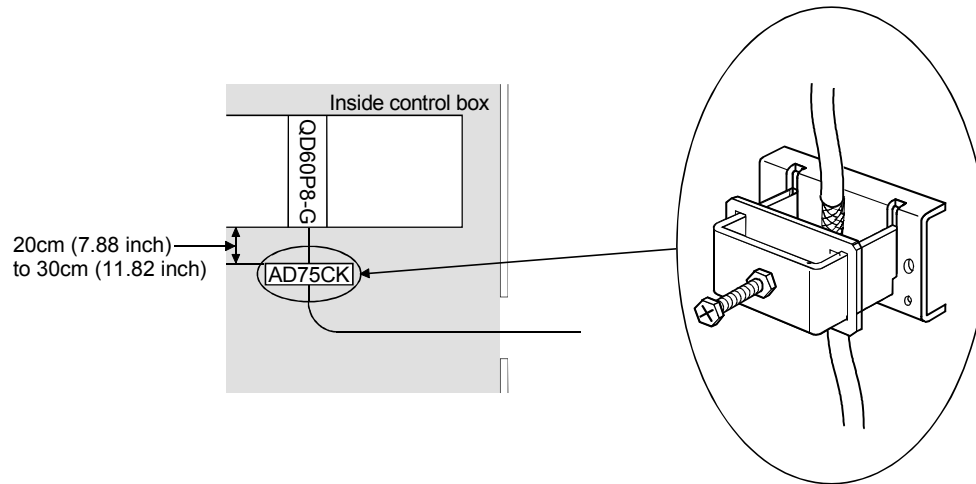

For details on the AD75CK, refer to the following.  
AD75CK-type Cable Clamping Instruction Manual

4.4.2 Wiring example

This section shows an example of wiring the QD60P8-G and pulse generator. In the wiring example of this section, only CH1 is wired. Also, in this example, the voltage of the external power supply is 24VDC as the electrical specifications of the pulse generator.

**! WARNING**

- When wiring, be sure to verify the rated voltage of the product as well as the terminal layout. Fire or failure may result if incorrect voltage is input or incorrect wiring is performed.
- Do not apply the voltage exceeding the value set on the "Intelligent function module switch setting" dialog box to the terminals. Failure to observe this may cause fire or failure.

(1) Wiring example with a source logic type pulse generator

(a) For transistor output

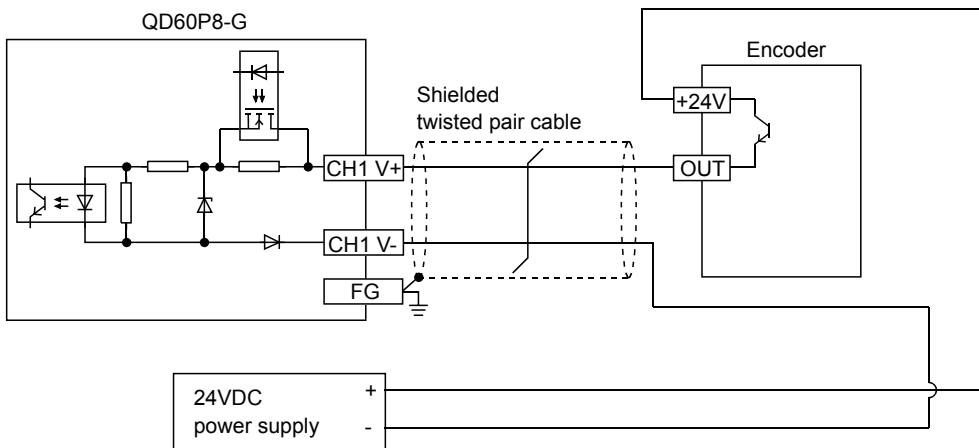

(b) For contact output

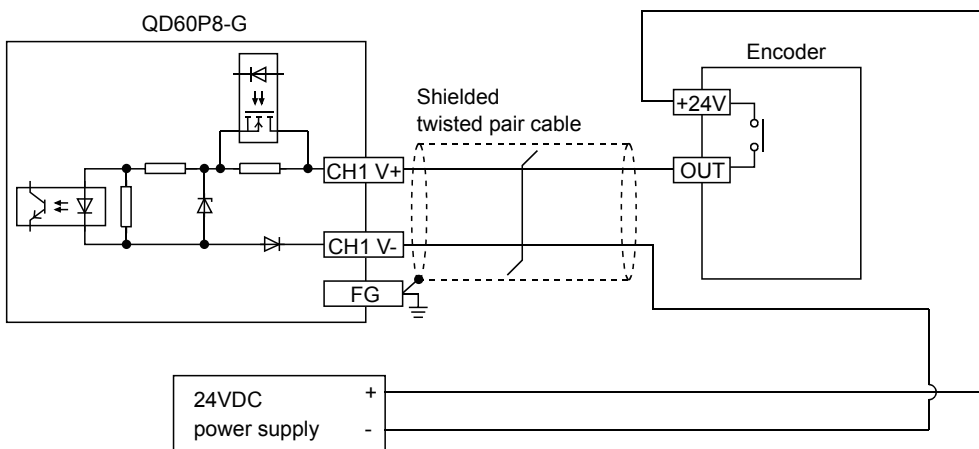

(2) Wiring example with a sink logic type pulse generator

(a) For transistor output

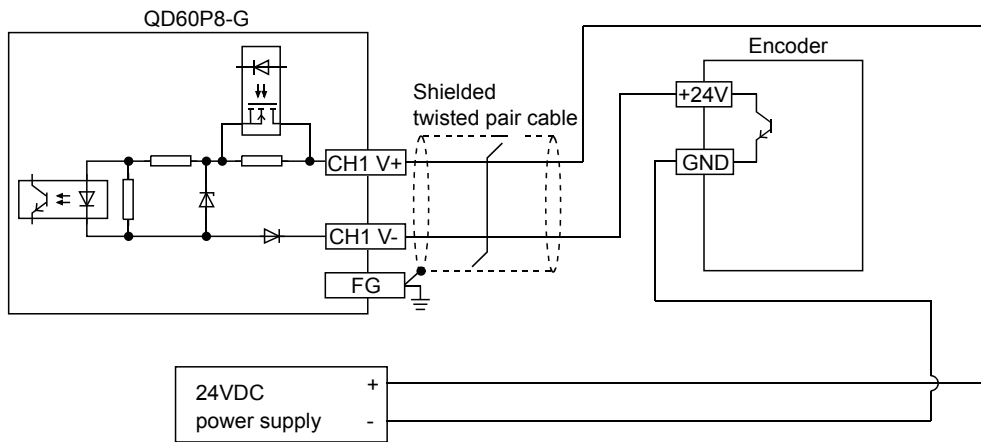

(b) For contact output

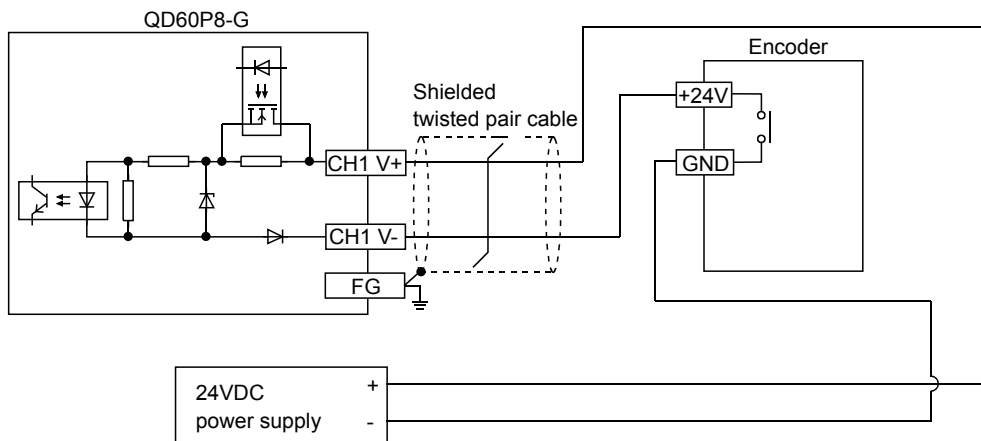



4.5 Setting from GX Developer

This section describes the GX Developer settings required to operate the QD60P8-G.

4.5.1 I/O assignment setting

Set the mounting status of the QD60P8-G on the I/O assignment setting.

- 1) Double-click "PLC parameter" in the project window in GX Developer.
- 2) Click the "I/O assignment" tab.
- 3) Set the following items to the slot on which the QD60P8-G is mounted.

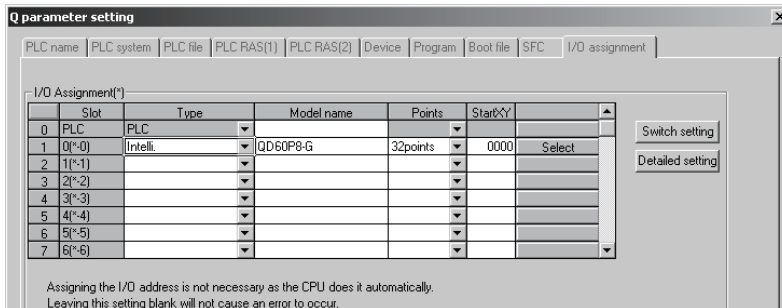

Item	Description
Type	Select "Intelli".
Model	Enter the model name of the module.
Points	Select "32points".
Start XY	Enter the start I/O number of the QD60P8-G.

4.5.2 Switch setting for the intelligent function module

Set the input voltage selection, pulse edge selection, linear counter or ring counter selection, and input filter.

Five switches (switch numbers 1 to 5) are available for the intelligent function module and they are set with 16-bit data.

If the switches for the intelligent function module are not set, the default value of 0 is used for switches 1 to 5.

- 1) Click the I/O assignment tab in the PC parameter dialog box of GX Developer. (Refer to Section 4.5.1)

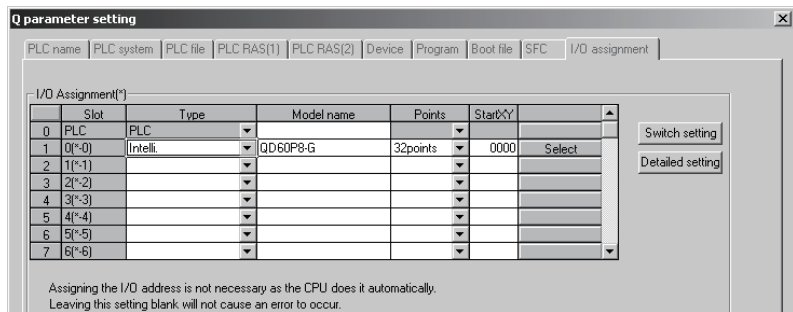

- 2) When clicking on the **Switch setting** button, the "Switch setting for I/O and intelligent function module" dialog box will be displayed. For the switch settings, refer to the following.

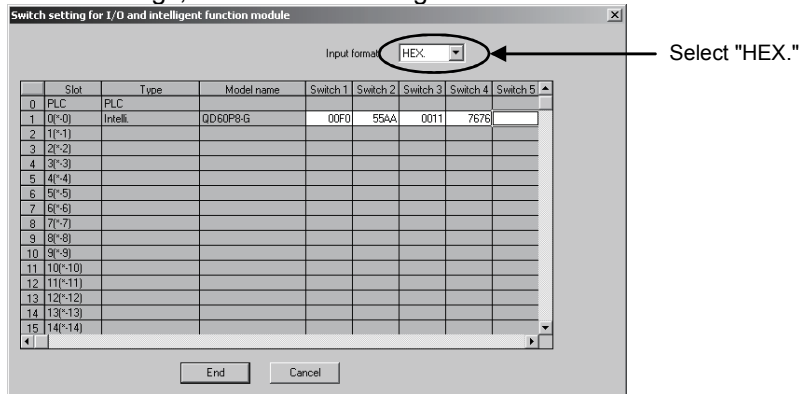

Switch No.	Data item	Description	Setting details/bit assignment	Default value
Switch 1	Input voltage selection	Set the levels of input signals.	b15 to b8 b7 to b0 0: fixed CH8 CH7 CH6 CH5 CH4 CH3 CH2 CH1 0: 12 to 24VDC 1: 5VDC	0000H
Switch 2	Pulse edge selection	Set the pulse edges (rise edge or fall edge). *1	b15 to b8 b7 to b0 CH8 CH7 CH6 CH5 CH4 CH3 CH2 CH1 CH8 CH7 CH6 CH5 CH4 CH3 CH2 CH1	0000H
	Linear counter or Ring counter selection	Set the count type (linear counter or ring counter). (Refer to Section 5.2)	Linear counter or Ring counter selection 0: Linear counter 1: Ring counter Pulse edge selection 0: Rise edge 1: Fall edge	

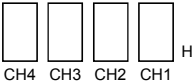
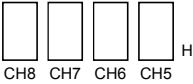
Switch No.	Data item	Description	Setting detail/bit assignment	Default value	
Switch 3	Input filter setting (CH1 to CH4)	Set the counting speed of input pulses (maximum). (Refer to Section 3.1)		Counting speed of input pulses (maximum) 0: 30kpps 1: 10kpps 2: 1kpps 3: 100pps 4: 50pps 5: 10pps 6: 1pps 7: 0.1pps	0000H
Switch 4	Input filter setting (CH5 to CH8)				0000H
Switch 5	No settings (blank) When any item is set, delete the settings and leave the field blank.				

\*1: For pulse edge selection, the differences between the rise edge and fall edge, and the count timings are shown below.

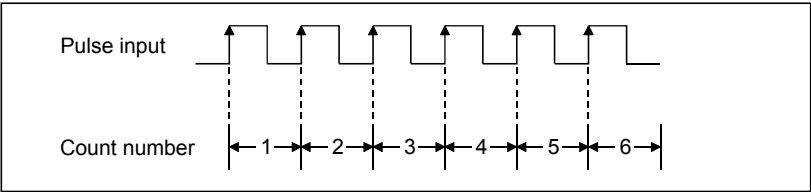
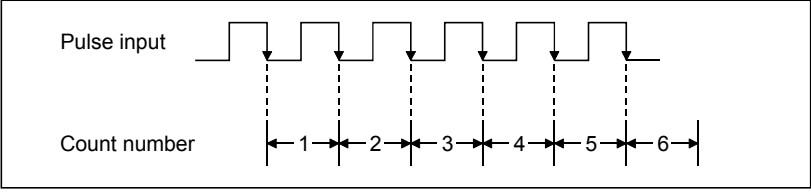
Pulse edge selection	Description
Rise edge	
Fall edge	

3) After the setting, click the **End** button.

CHAPTER 5 DETAILS AND SETTING OF FUNCTIONS

This chapter explains the details and settings of the QD60P8-G functions.

5.1 Count Operation

5.1.1 Pulse input method

The pulse input method of the QD60P8-G is 1-phase input and addition count. (Subtraction count is not available.) However, it is allowed to set whether pulses will be counted on the rise or fall by using the intelligent function module switches. Refer to Section 4.5.2 for details of the switch settings of intelligent function module.

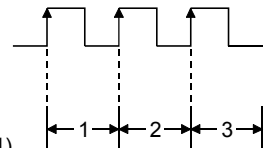
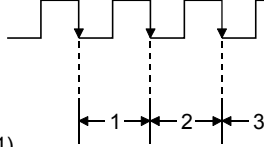
Pulse input method	Count timing	
1-phase	Pulse input from pulse generator (external)  Input pulse value (Buffer memory addresses: 10,11)	 Counted on rise (↑) of pulses
	Pulse input from pulse generator (external)  Input pulse value (Buffer memory addresses: 10,11)	 Counted on fall (↓) of pulses

5.1.2 Input pulse count operation

This section explains the input pulse count operation of the QD60P8-G. (For CH1)

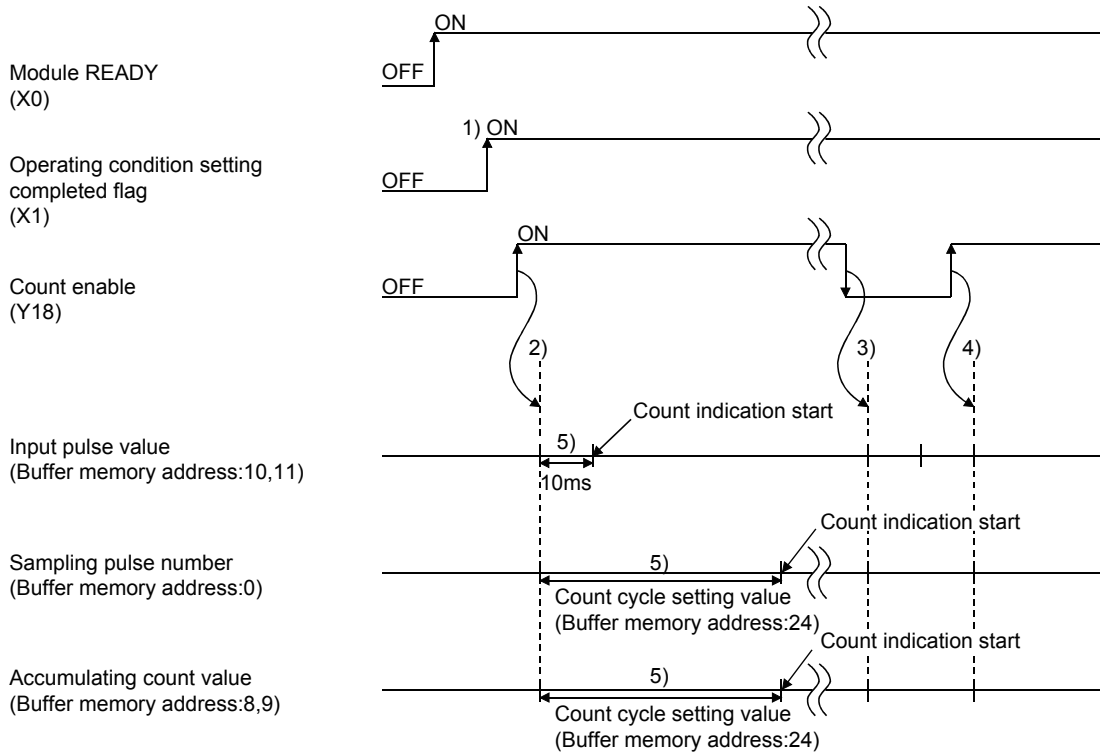

Number	Details
1)	When Operating condition setting completed flag (X1) turns on, pulse count operation is enabled. If any setting value or similar is in error, count operation cannot be performed since Operating condition setting completed flag (X1) does not turn on.
2)	When Count enable (Y18) is turned on, the count operation of CH1 starts.
3)	Count enable (Y18) turns off and pulse count operation stops.
4)	Count enable (Y18) turns on and pulse count operation is restarted.
5)	The indications of "Sampling pulse number" and "Accumulating count value" of the buffer memory are updated in the cycle set in "Count cycle setting value" of the buffer memory. (Refer to Section 5.1.4) (The update timing of "Input pulse value" of the buffer memory is fixed at 10ms.)

**REMARK**

In the pulse count operation of the QD60P8-G, is delayed due to the control cycle (10ms). Refer to Section 5.9 for details.

5.1.3 Count value reading

This section explains how to read the count values (Sampling pulse number, Accumulating count value, and Input pulse value) stored in the buffer memory.

Accumulating count value and Input pulse value are stored in the buffer memory as two words (32 bits). When reading the count value from the module, always read two words together.

The buffer memory addresses where the count values are stored are as follows.

Item	Buffer memory address							
	CH1	CH2	CH3	CH4	CH5	CH6	CH7	CH8
Sampling pulse number	0	32	64	96	128	160	192	224
Accumulating count value	8	40	72	104	136	168	200	232
	9	41	73	105	137	169	201	233
Input pulse value	10	42	74	106	138	170	202	234
	11	43	75	107	139	171	203	235

The buffer memory addresses of Counter reset request for resetting the count values are as follows.

Item	Buffer memory address							
	CH1	CH2	CH3	CH4	CH5	CH6	CH7	CH8
Counter reset request	13	45	77	109	141	173	205	237

The update timings of the count values are as follows.

Item	Update timing
Sampling pulse number	Count cycle setting value (Refer to Section 5.1.4)
Accumulating count value	
Input pulse value	10ms

**POINT**

When reading Accumulating count value or Input pulse value, always read two words together.

If it is read in single word unit, a wrong count value may be read due to a data mismatch between the lower word and upper word when the count value is updated halfway during read.

[Program example]



[Incorrect program example]

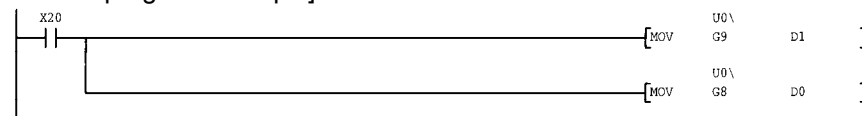

## 5.1.4 Count cycle changing

This section describes how to change the count cycles of Sampling pulse number and Accumulating count value.

To change the count cycle, set "1: Count cycle change function selection valid" in "Count cycle change function selection" of the buffer memory. (Whether the function is valid or invalid can be selected on each channel.)

Further, set the count cycle in "Count cycle setting value" of the buffer memory.

Item	Setting value	Buffer memory address							
		CH1	CH2	CH3	CH4	CH5	CH6	CH7	CH8
Count cycle change function selection	0: Count cycle change function selection invalid *								
	1: Count cycle change function selection valid	23	55	87	119	151	183	215	247
Count cycle setting value	0: 1s								
	1: 100ms								
	2: 200ms	24	56	88	120	152	184	216	248
	3: 500ms								

\*: When "Count cycle change function selection invalid" is set, the count cycle is 1s (fixed).

**POINT**

- If the setting value is other than the above values, a count cycle setting range outside error (Error code: 600) occurs. To clear the error, turn on Error reset request (Y8 to YF) of the corresponding channel. After this, set a correct value and then turn on Operating condition setting request flag (Y1).
- The settings are reflected on the module by turning on the operating condition setting request flag (Y1) after setting the values to the buffer memory.
- When measuring the frequency of the number of input pulse, set 1s for Count cycle setting value to treat the value in Sampling pulse number as a frequency. This eliminates the need of the program to calculate the counting value per second.
- The timing where the program reads the count value and the updating period of Count cycle setting value may cause errors in Accumulating count value.

## 5.2 Count Type Selection

Select the linear counter or ring counter by setting with the intelligent function module switch.

Refer to Section 4.5.2 for details of the setting method.

### 5.2.1 Linear counter operation

When the linear counter is selected, count operation is performed between 0 and 99999999.

If "Accumulating count value" of the buffer memory exceeds 99999999, the "Overflow detection flag" of the buffer memory turns on and an overflow error (Error code: 100) occurs.

The linear counter can be used with the comparison output function (refer to Section 5.4), pre-scale function (refer to Section 5.6), movement averaging function (refer to Section 5.7) and alarm output function (refer to Section 5.8).

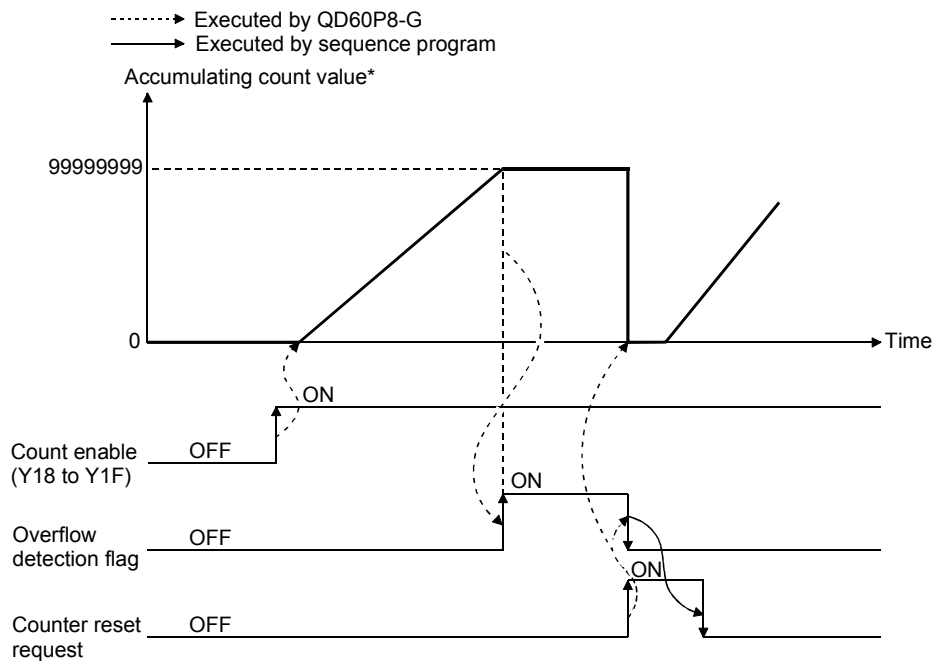

\*: The accumulating count value is updated in the cycle set in the "count cycle setting value" of the buffer memory. (Refer to Section 5.1.4)



- Overflow error

An overflow error (Error code: 100) occurs if "Accumulating count value" of the buffer memory exceeds 99999999 when the count type is the linear counter. If the overflow error occurs, count operation is stopped, and "Accumulating count value" of the buffer memory does not change from 99999999 if pulses are input. Also, "Sampling pulse number" of the buffer memory is reset.

The overflow error is cleared by setting "1" in "Counter reset request" of the buffer memory. Count operation is resumed after the error is cleared. The error is also cleared by turning on Error reset request (Y8 to YF). To resume count operation, however, turn on the operating condition setting request flag (Y1) or set "1" in "Counter reset request" of the buffer memory.

When checking for the module error at occurrence of an overflow error, click the [Diagnosis] - [System monitor] menu on GX Developer and monitor the system.

Item	Read value/Setting value	Buffer memory address							
		CH1	CH2	CH3	CH4	CH5	CH6	CH7	CH8
Accumulating count value	0 to 99999999	8	40	72	104	136	168	200	232
		9	41	73	105	137	169	201	233
Overflow detection flag	0: No overflow detection (OFF) 1: Overflow detection (ON)	12	44	76	108	140	172	204	236
Counter reset request	1: Reset request (The value automatically turns to "0" after completion of a counter reset.)	13	45	77	109	141	173	205	237

5.2.2 Ring counter operation

When the ring counter is selected, count operation is repeated between 0 and 99999999.

If "Accumulating count value" of the buffer memory exceeds 99999999, the accumulating count value returns to 0 and "Carry over detection flag" of the buffer memory turns on.

The ring counter can be used with the comparison output function (refer to Section 5.4), pre-scale function (refer to Section 5.6), movement averaging function (refer to Section 5.7) and alarm output function (refer to Section 5.8).

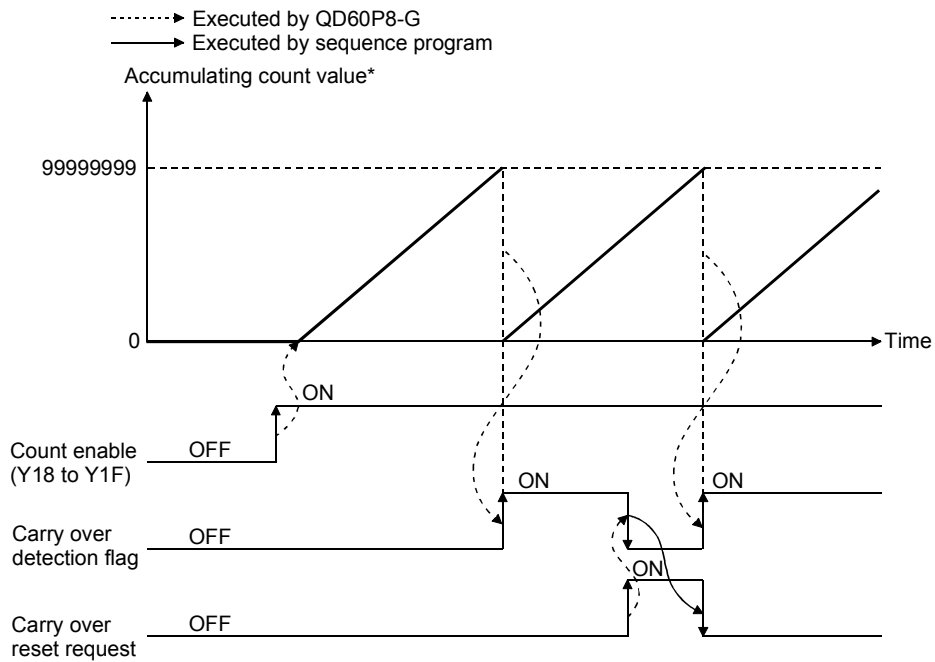

\*: The accumulating count value is updated in the cycle set in the "count cycle setting value" of the buffer memory. (Refer to Section 5.1.4)

Item	Read value/Setting value	Buffer memory address							
		CH1	CH2	CH3	CH4	CH5	CH6	CH7	CH8
Accumulating count value	0 to 99999999	8	40	72	104	136	168	200	232
		9	41	73	105	137	169	201	233
Carry over detection flag	0: No carry over detection (OFF) 1: Carry over detection (ON)	14	46	78	110	142	174	206	238
Carry over reset request	1: Reset request (The value automatically turns to "0" after completion of a carry over reset.)	15	47	79	111	143	175	207	239

**POINT**

Carry over detection flag is not cleared until Carry over reset request is given. Once cleared, Carry over detection flag does not turn on until Accumulating count value exceeds 99999999 again.

5.3 Input Pulse Value

The pulse number entered into the QD60P8-G is stored into "Input pulse value" of the buffer memory. This value is counted when Count enable (Y18 to Y1F) is on.

Input pulse value is not converted into the unit pulse number by the pre-scale function (refer to Section 5.6), unlike "Sampling pulse number" and "Accumulating count value" of the buffer memory. If an overflow error occurs, the value is counted when Count enable (Y18 to Y1F) is on.

The count type of Input pulse value is a ring counter of 0 to 2147483647.

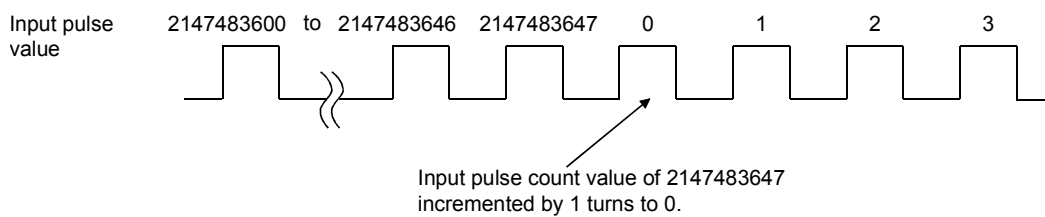

Item	Read value	Buffer memory address							
		CH1	CH2	CH3	CH4	CH5	CH6	CH7	CH8
Input pulse value	0 to 2147483647	10	42	74	106	138	170	202	234
		11	43	75	107	139	171	203	235

The buffer memory addresses for resetting Input pulse value are as follows.

Item	Buffer memory address							
	CH1	CH2	CH3	CH4	CH5	CH6	CH7	CH8
Counter reset request	13	45	77	109	141	173	205	237

<b>POINT</b>
<ul style="list-style-type: none"> <li>• The update timing of Input pulse value is fixed at 10ms. Therefore, take care when using the module as a counter. (Refer to Section 5.9)</li> <li>• When reading Input pulse value, always read two words together. If it is read in single word unit, a wrong count value may be read due to a data mismatch between the lower word and upper word when the count value is updated halfway during read.</li> </ul>

## 5.4 Comparison Output Function

The comparison output function compares any count value set in "Comparison output setting value" of the buffer memory with "Accumulating count value" of the buffer memory, and if "Accumulating count value" is equal to or greater than "Comparison output setting value", turns on Accumulating counter comparison flag (X10 to X17).

Set one point of Comparison output setting value for each channel.

The buffer memory addresses related to the setting of the comparison output function are as follows.

Item	Read value/Setting value	Buffer memory address							
		CH1	CH2	CH3	CH4	CH5	CH6	CH7	CH8
Comparison output selection	0: Comparison output function invalid	1	33	65	97	129	161	193	225
	1: Comparison output function valid								
Comparison output setting value	0 to 99999999	2	34	66	98	130	162	194	226
		3	35	67	99	131	163	195	227
Accumulating count value	0 to 99999999	8	40	72	104	136	168	200	232
		9	41	73	105	137	169	201	233

The I/O signals (X/Y devices) related to the setting of the comparison output function are as follows.

Item	Read value/Setting value	X/Y device							
		CH1	CH2	CH3	CH4	CH5	CH6	CH7	CH8
Accumulating counter comparison flag	OFF: Accumulating count value < Comparison output setting value	X10	X11	X12	X13	X14	X15	X16	X17
	ON: Accumulating count value $\geq$ Comparison output setting value								
Comparison signal reset request	OFF: No comparison signal reset request	Y10	Y11	Y12	Y13	Y14	Y15	Y16	Y17
	ON: Comparison signal reset request								

**POINT**

- If the value outside the range is set to any of the above buffer memory addresses, a comparison output setting range outside error (Error code: 200) occurs. To clear the error, turn on Error reset request (Y8 to YF) of the corresponding channel. After this, set a value within the setting range and then turn on Operating condition setting request flag (Y1).
- The settings are reflected on the module by turning on the operating condition setting request flag (Y1) after setting the values to the buffer memory.

Outline of comparison output function operation

The following gives the outline of the comparison output function operation. (For CH1)

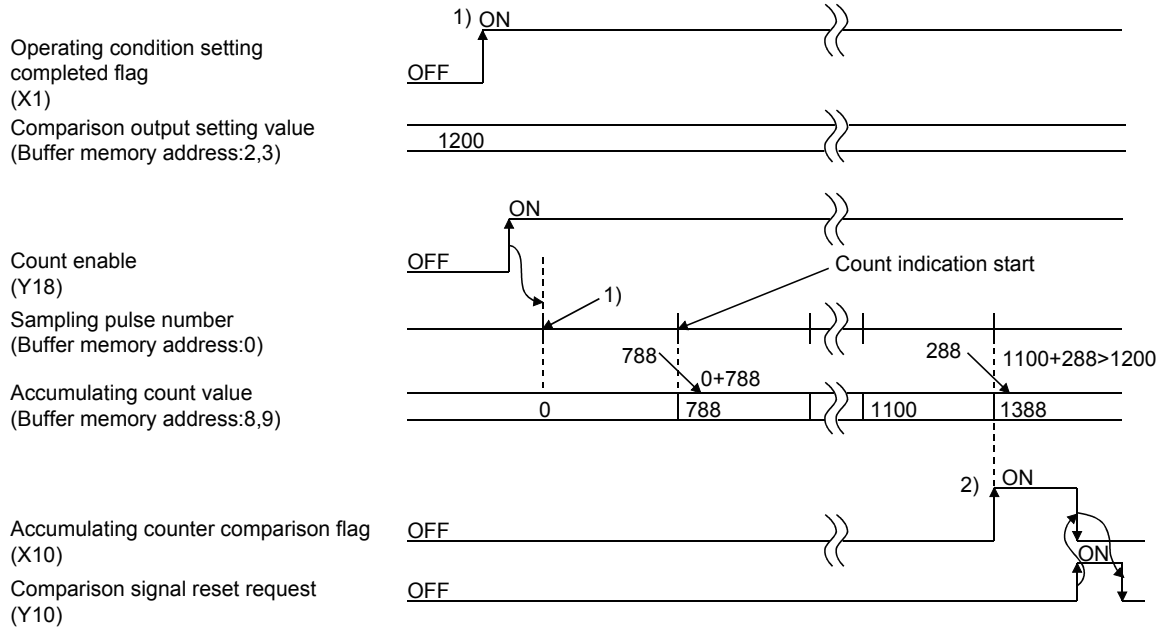

Number	Details
1)	Count operation is started when Count enable (Y18) is turned on with Operating condition setting completed flag (X1) on.
2)	When "Accumulating count value" is equal to or greater than "Comparison output setting value", Accumulating counter comparison flag (X10) turns on. Since Accumulating count value is updated at intervals of Count cycle setting value (refer to Section 5.1.2), the accumulating counter comparison flag is also turned on at the timing of the count cycle setting value.

POINT
Accumulating counter comparison flag (X10 to X17) is reset when Comparison signal reset request (Y10 to Y17) is turned on. When the accumulating counter is operating as a linear counter, Accumulating counter comparison flag (X10 to X17) that was turned off once does not turn on until Accumulating count value reaches Comparison output setting value again after it has been reset. If the accumulating counter is operating as a ring counter, the flag turns on when Accumulating count value reaches Comparison output setting value again in the ring processing.

## 5.5 Counter Reset Function

Setting "1" in "Counter reset request" of the buffer memory resets "Sampling pulse number", "Accumulating count value", or "Input pulse value" of the buffer memory.

Item	Setting value	Buffer memory address							
		CH1	CH2	CH3	CH4	CH5	CH6	CH7	CH8
Counter reset request	1: Reset request (The value automatically turns to "0" after completion of a counter reset.)	13	45	77	109	141	173	205	237

**POINT**

- When the counter is reset, input pulses are invalid for a maximum of 20ms.
- When the accumulating counter is the linear counter, count operation that was stopped due to the detection of an overflow is started after completion of a counter reset.
- If a value other than 1 is set, the setting is ignored.

5.6 Pre-scale Function

The pre-scale function converts the number of pulses by multiplying the number of input pulses by an arbitrary setting number.

The pre-scale function converts Input pulse value per count cycle into the unit pulse number using the following operation formula. The result of conversion is stored into "Sampling pulse number" of the buffer memory.

$$\text{Sampling pulse number} = \text{Input pulse value per count cycle} \times \text{Pre-scale setting value} \times \text{Unit magnification}$$

(The converted sampling pulse number is rounded down to the decimal point.)

Item	Setting value	Buffer memory address							
		CH1	CH2	CH3	CH4	CH5	CH6	CH7	CH8
Pre-scale function selection (Unit magnification)	0: Pre-scale function invalid								
	1: $\times 1$								
	2: $\times 0.1$	6	38	70	102	134	166	198	230
	3: $\times 0.01$								
	4: $\times 0.001$								
5: $\times 0.0001$									
Pre-scale setting value	0 to 32767	7	39	71	103	135	167	199	231

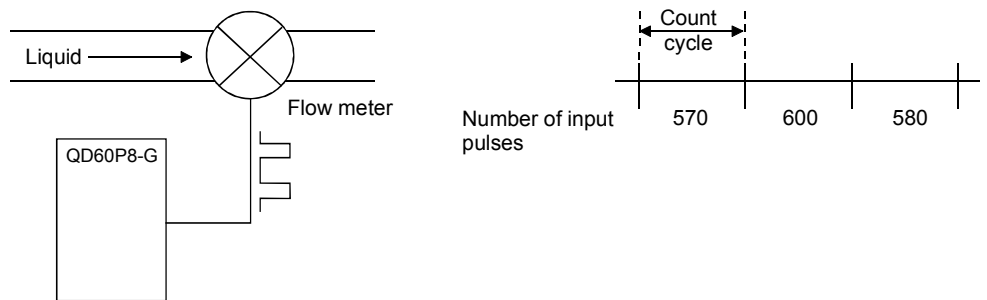

(Example)

Suppose the pulse is input from the flow meter every 3cm<sup>3</sup> flow.

In this case, set the followings in the buffer memory to convert the value stored in Sampling pulse number to the flow rate (in [cm<sup>3</sup>] unit).

- Pre-scale setting value: 3
- Pre-scale function selection: 1 ( $\times 1$ )
- Count cycle setting value: 0 (1s)

When the above settings are made and the number of input pulses is 570 per a count cycle (1s), the following value will be stored to Sampling pulse number.

$$\begin{aligned} \text{Sampling pulse number} &= \text{Input pulse value in a count cycle} \times \text{Pre-scale setting value} \times \text{Unit magnification} \\ &= 570 \times 3 \times 1 \\ &= 1710[\text{cm}^3/\text{s}] \end{aligned}$$

Values of Sampling pulse number are added to Accumulating count value every set count cycle. This leads to the conversion of accumulating count value to [cm<sup>3</sup>] unit.



**POINT**

- Note that if Pre-scale setting value is set to 0, Sampling pulse number calculated with the above operation formula becomes 0, and it seems as if pulses are not counted although they are actually counted.
- If the setting value is other than the above values, a pre-scale setting range outside error (Error code: 400) occurs. To clear the error, turn on Error reset request (Y8 to YF) of the corresponding channel. After this, set a correct value and then turn on Operating condition setting request flag (Y1).
- The settings are reflected on the module by turning on the operating condition setting request flag (Y1) after setting the values to the buffer memory.

### 5.7 Movement Averaging Function

The movement averaging function averages the values of Sampling pulse number, which were imported in the count cycle (refer to Section 5.1.4), by the specified number of times to calculate the average value. This function is used when variations occur in the values of Sampling pulse number.

The following shows the outline of movement averaging function operation.

Movement averaging processing performed when the setting number is four times.

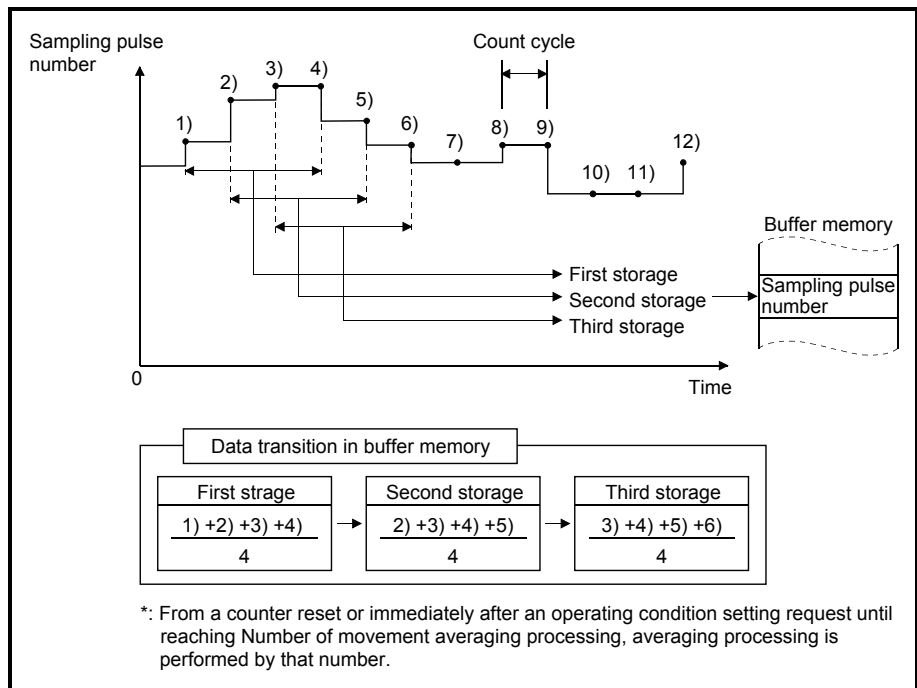

Item	Read value/Setting value	Buffer memory address							
		CH1	CH2	CH3	CH4	CH5	CH6	CH7	CH8
Sampling pulse number	0 to 32767	0	32	64	96	128	160	192	224
Movement averaging processing selection	0: Sampling processing 1: Movement averaging processing	4	36	68	100	132	164	196	228
Number of movement averaging processing	2 to 60	5	37	69	101	133	165	197	229

#### POINT

- If the setting value is other than the above values, a movement averaging setting range outside error (Error code: 300) occurs. To clear the error, turn on Error reset request (Y8 to YF) of the corresponding channel. After this, set a correct value and then turn on Operating condition setting request flag (Y1).
- The settings are reflected on the module by turning on Operating condition setting request flag (Y1) after setting the values to the buffer memory.

5.8 Alarm Output Function

With "alarm output function valid" set in "Alarm output selection" of the buffer memory, the alarm output function outputs an alarm if "Sampling pulse number" of the buffer memory exceeds the upper/upper limit value or lower/lower limit value. The alarm is turned off if Sampling pulse number is below the upper/lower limit value or above the lower/upper limit value after the output of the alarm.

To set the alarm output function, set four points: upper/upper limit value, upper/lower limit value, lower/upper limit value and lower/lower limit value.

The buffer memory addresses related to the setting of the alarm output function are as follows.

Item	Setting value	Buffer memory address							
		CH1	CH2	CH3	CH4	CH5	CH6	CH7	CH8
Alarm output selection	0: Alarm output function invalid 1: Alarm output function valid	17	49	81	113	145	177	209	241
Alarm output setting value upper/upper limit	0 to 32767	19	51	83	115	147	179	211	243
Alarm output setting value upper/lower limit		20	52	84	116	148	180	212	244
Alarm output setting value lower/upper limit		21	53	85	117	149	181	213	245
Alarm output setting value lower/lower limit		22	54	86	118	150	182	214	246

If the setting value is other than in the above values or does not establish the following relation expression, an alarm output setting range outside error (Error code: 500) occurs.

$$\text{Upper/upper limit} \geq \text{upper/lower limit} > \text{lower/upper limit} \geq \text{lower/lower limit}$$

To clear the error, turn on Error reset request (Y8 to YF) of the corresponding channel. After this, set a correct value (value that will establish the above relation expression and is within the setting range), and then turn on Operating condition setting request flag (Y1).

The buffer memory addresses related to the alarm output are as follows.

Item	Read value	Buffer memory address							
		CH1	CH2	CH3	CH4	CH5	CH6	CH7	CH8
Sampling pulse number	0 to 32767	0	32	64	96	128	160	192	224
Alarm output flag	bit0: Lower limit alarm bit8: Upper limit alarm	18	50	82	114	146	178	210	242

[Bit pattern of alarm output]

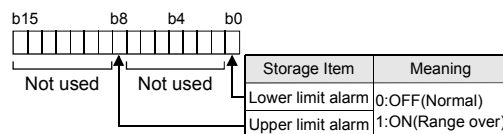

Outline of alarm output function operation

The following gives the outline of the alarm output function operation.

- Example of alarm output operation

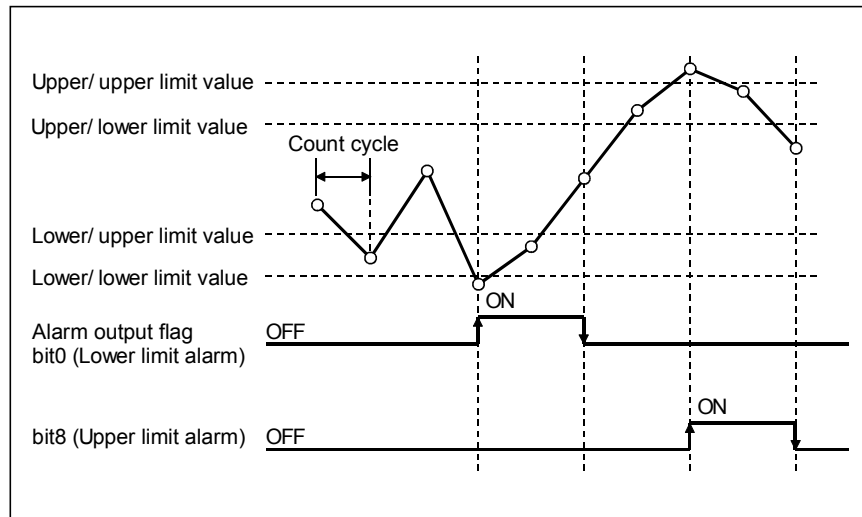

- Assuming that the upper/upper limit = upper/lower limit and lower/upper limit = lower/lower limit, operation is performed as shown below.

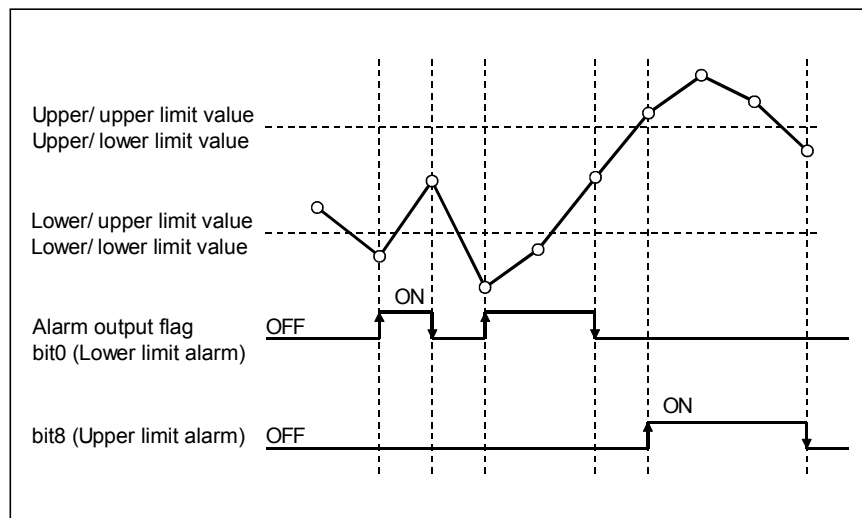

**POINT**

- Since "Sampling pulse number" of the buffer memory is updated at intervals of Count cycle setting value (refer to Section 5.1.4), the alarm output flag also turns on/off at the timing of the count cycle setting value.
- The settings are reflected on the module by turning on Operating condition setting request flag (Y1) after setting the values to the buffer memory.

### 5.9 Count Response Delay Time

The count value of the QD60P8-G is delayed for the following reasons. Please take this into consideration when using the module as a counter.

- A delay occurs due to the scan time of a sequence program at the time of count start processing using Count enable (Y18 to Y1F).
- A delay occurs due to the control cycle (10ms). A maximum of 20ms (one control cycle  $\times$  2) delay occurs from when Count enable (Y18 to Y1F) is turned on/off until "Input pulse value" of the buffer memory is displayed. Similarly, a delay also occurs at a counter reset request.

The calculation expression of the delay time is as indicated below.

$$\text{Maximum delay time [ms]} = (1 \text{ scan time} + 20) \text{ [ms]}$$

## CHAPTER 6 UTILITY PACKAGE (GX Configurator-CT)

The counter module utility package (GX Configurator-CT) is software designed to make initial setting, auto refresh setting, monitor/test of the QD60P8-G using dedicated screens, without being conscious of the I/O signals and buffer memory. Use the utility package with GX Developer (SW4D5C-GPPW-E or later).

## 6.1 Utility Package Functions

The following table gives the lists the functions of the utility package.

Utility package (GX Configurator-CT) function list

Function	Details	Reference
Initial setting	<p>Make initial setting for operating the QD60P8-G for each channel. Set the values of the items which require initial setting.</p> <p>[Setting items]</p> <ul style="list-style-type: none"> <li>• CH <input type="checkbox"/> Comparison output selection</li> <li>• CH <input type="checkbox"/> Comparison output setting value</li> <li>• CH <input type="checkbox"/> Movement averaging processing selection</li> <li>• CH <input type="checkbox"/> Number of movement averaging processing</li> <li>• CH <input type="checkbox"/> Pre-scale function selection</li> <li>• CH <input type="checkbox"/> Pre-scale setting value</li> <li>• CH <input type="checkbox"/> Alarm output selection</li> <li>• CH <input type="checkbox"/> Alarm output setting value upper/upper limit</li> <li>• CH <input type="checkbox"/> Alarm output setting value upper/lower limit</li> <li>• CH <input type="checkbox"/> Alarm output setting value lower/upper limit</li> <li>• CH <input type="checkbox"/> Alarm output setting value lower/lower limit</li> <li>• CH <input type="checkbox"/> Count cycle change function selection</li> <li>• CH <input type="checkbox"/> Count cycle setting value</li> </ul> <p>(The initially set data are registered to the programmable controller CPU parameters, and when the programmable controller CPU is set to the RUN status, they are written to the QD60P8-G automatically.)</p>	Section 6.4
Auto refresh setting	<p>Set the buffer memory batch to be automatically refreshed for each channel of the QD60P8-G.</p> <p>[Auto refresh target buffer memory values]</p> <ul style="list-style-type: none"> <li>• Sampling pulse number</li> <li>• Comparison output selection</li> <li>• Comparison output setting value</li> <li>• Movement averaging processing selection</li> <li>• Number of movement averaging processing</li> <li>• Pre-scale function selection</li> <li>• Pre-scale setting value</li> <li>• Accumulating count value</li> <li>• Input pulse value</li> <li>• Overflow detection flag</li> <li>• Counter reset request</li> <li>• Carry over detection flag</li> <li>• Carry over reset request</li> <li>• Error code</li> <li>• Alarm output selection</li> <li>• Alarm output flag</li> <li>• Alarm output setting value upper/upper limit</li> <li>• Alarm output setting value upper/lower limit</li> <li>• Alarm output setting value lower/upper limit</li> <li>• Alarm output setting value lower/lower limit</li> <li>• Count cycle change function selection</li> <li>• Count cycle setting value</li> </ul> <p>(The values stored in the automatically refreshed QD60P8-G buffer memory are read automatically when the END instruction of the programmable controller CPU is executed.)</p>	Section 6.5
Monitor/Test	<p>Monitors and tests the buffer memory and I/O signals for the QD60P8-G.</p> <ul style="list-style-type: none"> <li>• X/Y Monitor/Test</li> <li>• CH <input type="checkbox"/> Monitor/Test</li> </ul>	Section 6.6

## 6.2 Installing and Uninstalling the Utility Package

For how to install or uninstall the utility package, refer to "Method of installing the MELSOFT Series" included in the utility package.

### 6.2.1 Handling precautions

The following explains the precautions on using the Utility package.

(1) **For safety**

Since utility is add-in software for GX Developer, read "Safety Precautions" and the basic operating procedures in the GX Developer Operating Manual.

(2) **About installation**

GX Configurator- CT is add-in software for GX Developer Version 4 or later. Therefore, GX Configurator- CT must be installed on the personal computer that has already GX Developer Version 4 or later installed.

(3) **Screen error of Intelligent function module utility**

Insufficient system resource may cause the screen to be displayed inappropriately while using the Intelligent function module utility.

If this occurs, close the Intelligent function module utility, GX Developer (program, comments, etc.), and other applications, and then start GX Developer and Intelligent function module utility again.

(4) **To start the Intelligent function module utility**

(a) In GX Developer, select "QCPU (Q mode)" for PLC series and specify a project.

If any PLC series other than "QCPU (Q mode)" is selected, or if no project is specified, the Intelligent function module utility will not start.

(b) Multiple Intelligent function module utilities can be started.

However, [Open parameters] and [Save parameters] operations under [Intelligent function module parameter] are allowed for one Intelligent function module utility only. Only the [Monitor/test] operation is allowed for the other utilities.

(5) **Switching between two or more Intelligent function module utilities**

When two or more Intelligent function module utility screens cannot be displayed side by side, select a screen to be displayed on the top of others using the task bar.



(6) Number of parameters that can be set in GX Configurator-CT

When multiple intelligent function modules are mounted, the number of parameter settings must not exceed the following limit.

When intelligent function modules are installed to:	Maximum number of parameter settings	
	Initial setting	Auto refresh setting
Q00J/Q00/Q01CPU	512	256
Q02/Q02H/Q06H/Q12H/Q25HCPU	512	256
Q02PH/Q06PH/Q12PH/Q25PHCPU	512	256
Q12PRH/Q25PRHCPU	512	256
Q00UJ/Q00U/Q01UCPU	512	256
Q02UCPU	2048	1024
Q03UD/Q04UDH/Q06UDH/Q10UDH/ Q13UDH/Q20UDH/Q26UDH/Q03UDE/ Q04UDEH/Q06UDEH/Q10UDEH/ Q13UDEH/Q20UDEH/Q26UDEHCPU	4096	2048
Q50UDEH/Q100UDEHCPU	Not supported	Not supported
MELSECNET/H remote I/O station	512	256

For example, if multiple intelligent function modules are installed to the MELSECNET/H remote I/O station, configure the settings in GX Configurator so that the number of parameter settings for all the intelligent function modules does not exceed the limit of the MELSECNET/H remote I/O station. Calculate the total number of parameter settings separately for the initial setting and for the auto refresh setting.

The number of parameters that can be set for one module in GX Configurator-CT is as shown below.

Target Module	Initial setting	Auto refresh setting
QD60P8-G	24 (Fixed)	8 (Max.)

(Example)

Counting the number of parameter settings in Auto refresh setting

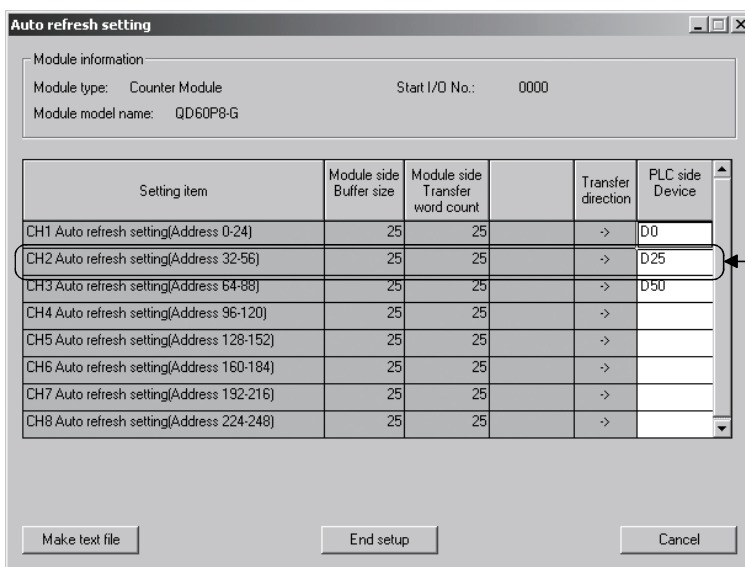

This one row is counted as one setting. Blank rows are not counted. Count up all the setting items on this screen, and add the total to the number of settings for other intelligent function modules to get a grand total.



## 6.2.2 Operating environment

This section explains the operating environment of the personal computer that runs GX Configurator-CT.

Item	Description
Installation (Add-in) target * <sup>1</sup>	Add-in to GX Developer Version 4 (English version) or later* <sup>2</sup>
Computer	Windows® -based personal computer
	CPU
	Required memory
	Refer to the following table "Used operating system and performance required for personal computer".
Hard disk space* <sup>3</sup>	For installation
	For operation
	65 MB or more
	10 MB or more
Display	800 × 600 dots or more resolution* <sup>4</sup>
Operating system	Microsoft® Windows® 95 Operating System (English version) Microsoft® Windows® 98 Operating System (English version) Microsoft® Windows® Millennium Edition Operating System (English version) Microsoft® Windows NT® Workstation Operating System Version 4.0 (English version) Microsoft® Windows® 2000 Professional Operating System (English version) Microsoft® Windows® XP Professional Operating System (English version) Microsoft® Windows® XP Home Edition Operating System (English version) Microsoft® Windows Vista® Home Basic Operating System (English version) Microsoft® Windows Vista® Home Premium Operating System (English version) Microsoft® Windows Vista® Business Operating System (English version) Microsoft® Windows Vista® Ultimate Operating System (English version) Microsoft® Windows Vista® Enterprise Operating System (English version)

\*1: Install GX Configurator-CT in GX Developer Version 4 or higher in the same language.

GX Developer (English version) and GX Configurator-CT (Japanese version) cannot be used in combination, and GX Developer (Japanese version) and GX Configurator-CT (English version) cannot be used in combination.

\*2: GX Configurator-CT is not applicable to GX Developer Version 3 or earlier.

\*3: At least 15GB is required for Windows Vista® .

\*4: Resolution of 1024 × 768 dots or more is recommended for Windows Vista® .

## Operating system and performance required for personal computer

Operating system	Performance Required for Personal computer	
	CPU	Memory
Windows® 95	Pentium® 133MHz or more	32MB or more
Windows® 98	Pentium® 133MHz or more	32MB or more
Windows® Me	Pentium® 150MHz or more	32MB or more
Windows NT® Workstation 4.0	Pentium® 133MHz or more	32MB or more
Windows® 2000 Professional	Pentium® 133MHz or more	64MB or more
Windows® XP Professional (Service Pack 1 or more)	Pentium® 300MHz or more	128MB or more
Windows® XP Home Edition (Service Pack 1 or more)	Pentium® 300MHz or more	128MB or more
Windows Vista® Home Basic	Pentium® 1GHz or more	1GB or more
Windows Vista® Home Premium	Pentium® 1GHz or more	1GB or more
Windows Vista® Business	Pentium® 1GHz or more	1GB or more
Windows Vista® Ultimate	Pentium® 1GHz or more	1GB or more
Windows Vista® Enterprise	Pentium® 1GHz or more	1GB or more

**POINT**

The functions shown below are not available for Windows® XP and Windows Vista® .

If any of the following functions is attempted, this product may not operate normally.

- Start of application in Windows® compatible mode
- Fast user switching
- Remote desktop
- Large fonts (Details setting of Display Properties)

Also, 64-bit version Windows® XP and Windows Vista® are not supported.









Use a User authorization or higher in Windows Vista® .

## 6.3 Utility Package Operation

### 6.3.1 Common utility package operations

#### (1) Control keys

Special keys that can be used for operation of the utility package and their applications are shown in the table below.

Key	Application
	Cancels the current entry in a cell. Closes the window.
	Moves between controls in the window.
	Used in combination with the mouse operation to select multiple cells for test execution.
	Deletes the character where the cursor is positioned. When a cell is selected, clears all of the setting contents in the cell.
	Deletes the character where the cursor is positioned.
	Moves the cursor.
	Moves the cursor one page up.
	Moves the cursor one page down.
	Completes the entry in the cell.

#### (2) Data created with the utility package

The following data or files that are created with the utility package can be also handled in GX Developer. Figure 6.1 shows respective data or files are handled in which operation.

##### <Intelligent function module parameter>

- (a) This represents the data created in Auto refresh setting, and they are stored in an intelligent function module parameter file in a project created by GX Developer.

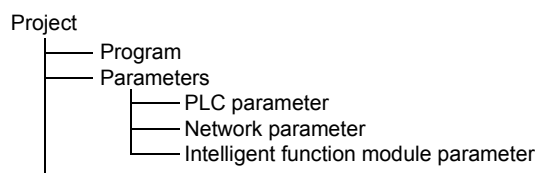

- (b) Steps 1) to 3) shown in Figure 6.1 are performed as follows:

- 1) From GX Developer, select:  
[Project] → [Open project] / [Save] / [Save as]
- 2) On the intelligent function module selection screen of the utility, select:  
[Intelligent function module parameter] → [Open parameters] / [Save parameters]

- 3) From GX Developer, select:  
 [Online] → [Read from PLC] / [Write to PLC] → "Intelligent function module parameters"  
 Alternatively, from the intelligent function module selection screen of the utility, select:  
 [Online] → [Read from PLC] / [Write to PLC]

<Text files>

- (a) A text file can be created by clicking the Make text file button on the initial setting, Auto refresh setting, or Monitor/Test screen. The text files can be utilized to create user documents.

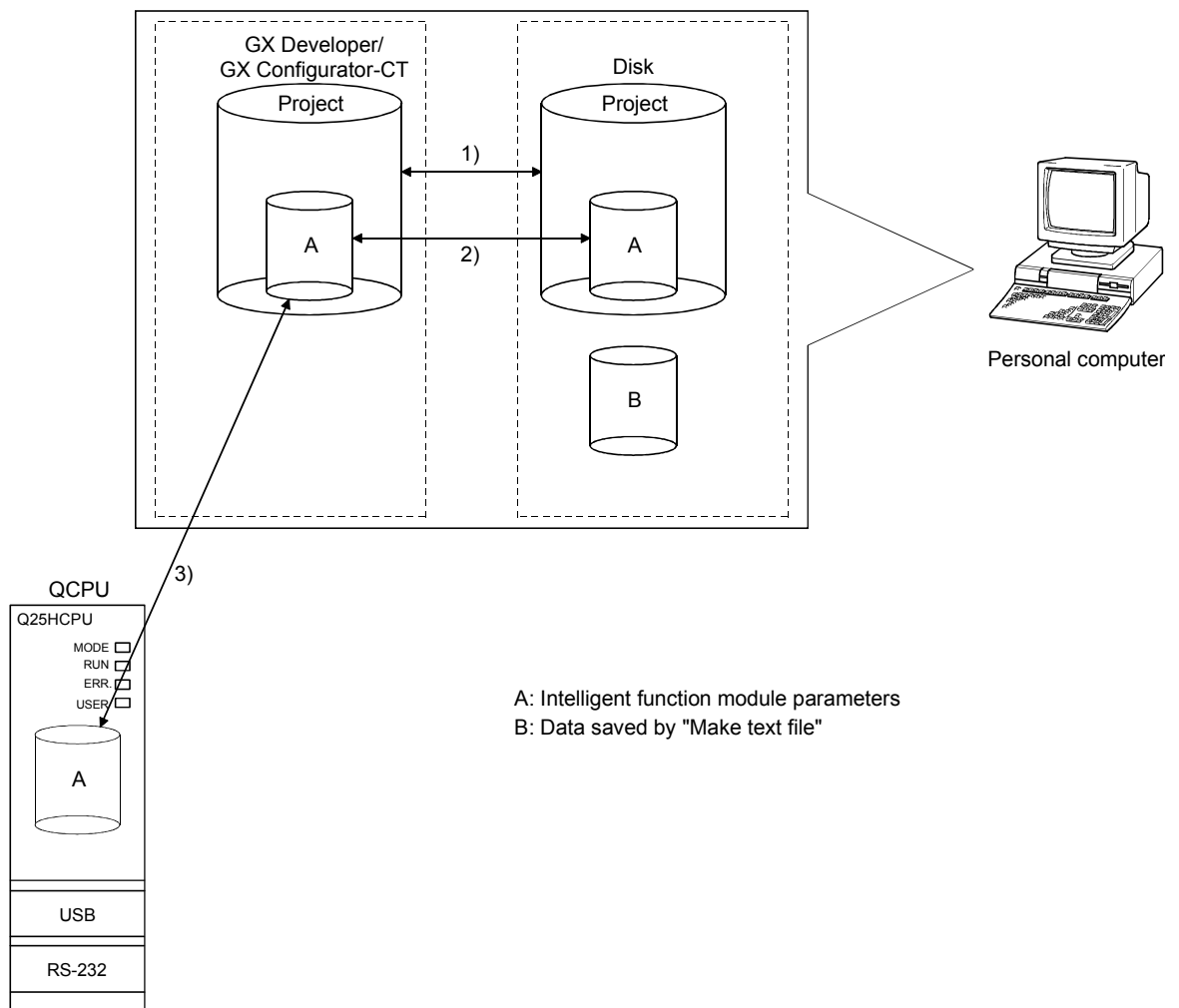
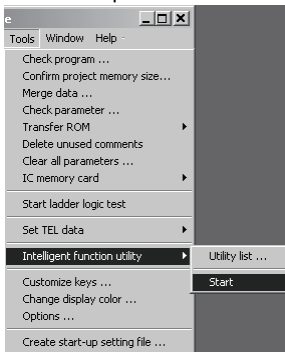

Figure 6.1 Correlation chart for data created with the utility package

6.3.2 Operation overview

GX Developer screen



[Tools] - [Intelligent function utility] - [Start]

Screen for selecting a target intelligent function module

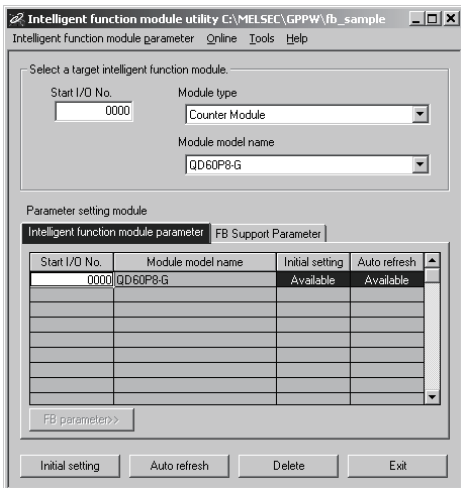

Enter "Start I/O No.", and select "Module type" and "Module model name".

Refer to Section 6.3.3

To the next page 1)

Initial setting

Auto refresh

Initial setting screen

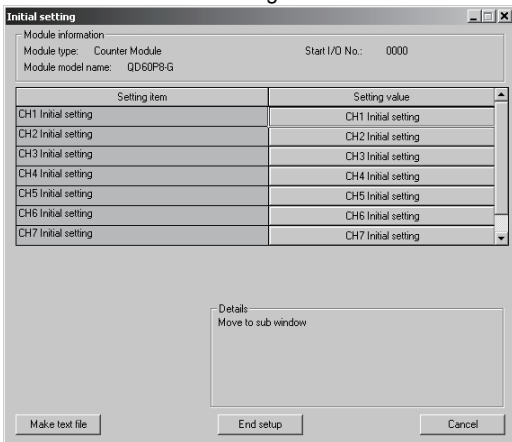

Refer to Section 6.4

Auto refresh setting screen

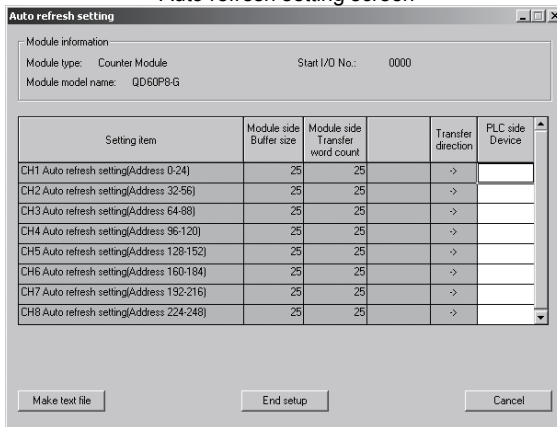

Refer to Section 6.5

From the previous page 1)

[Online] - [Monitor/Test]

Selecting monitor/test module screen

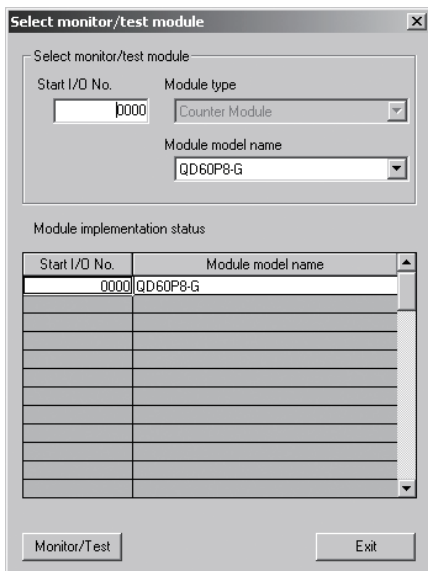

Monitor/Test

Select a module to be monitored/tested.

Monitor/Test screen

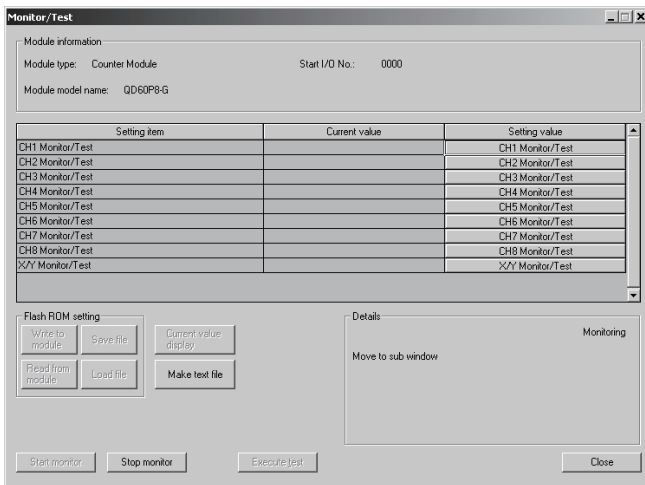

Refer to Section 6.6

## 6.3.3 Starting the intelligent function module utility

## [Operating procedure]

Intelligent function module utility is started from GX Developer.

[Tools] → [Intelligent function utility] → [Start]

## [Setting screen]

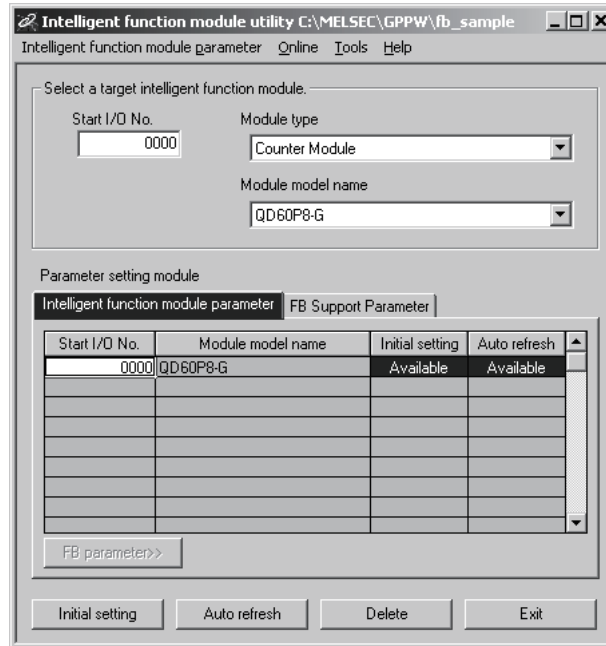

## [Explanation of items]

## (1) Activation of other screens

Following screens can be displayed from the intelligent function module utility screen.

## (a) Initial setting screen

"Start I/O No. \*1 " → "Module type" → "Module model name" →

**Initial setting**

## (b) Auto refresh setting screen

"Start I/O No. \*1 " → "Module type" → "Module model name" →

**Auto refresh**

## (c) Select monitor/test module screen

[Online] → [Monitor/Test]

\*1 Enter the start I/O No. in hexadecimal.

## (2) Command buttons

**Delete** Deletes the initial setting and auto refresh setting of the selected module.

**Exit** Closes this screen.

## (3) Menu bar

## (a) File menu

Intelligent function module parameters of the project opened by GX Developer are handled.

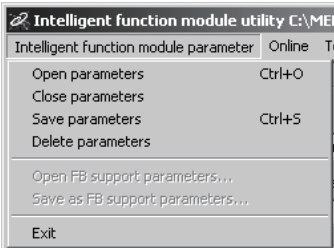

[Open parameters] : Reads a parameter file.

[Close parameters] : Closes the parameter file. If any data are modified, a dialog asking for file saving will appear.

[Save parameters] : Saves the parameter file.

[Delete parameters] : Deletes the parameter file.

[Open FB support parameters] : Opens a FB support parameter file.

[Save as FB support parameters] : Saves a FB support parameter.

[Exit] : Closes this screen.

## (b) Online menu

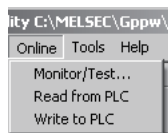

[Monitor/Test] : Activates the Select monitor/test module screen.

[Read from PLC] : Reads intelligent function module parameters from the CPU module.

[Write to PLC] : Writes intelligent function module parameters to the CPU module.

## POINT

## (1) Saving intelligent function module parameters in a file

Since intelligent function module parameters cannot be saved in a file by the project saving operation of GX Developer, save them on the shown module selection screen.

## (2) Reading/writing intelligent function module parameters from/to a programmable controller CPU using GX Developer

(a) Intelligent function module parameters can be read from and written into a programmable controller CPU after having been saved in a file.

(b) Set a target programmable controller CPU in GX Developer:

[Online] → [Transfer setup].

(c) When mounting the QD60P8-G on a remote I/O station, use Read from PLC and Write to PLC of GX Developer.

## (3) Checking the required utility

While the start I/O is displayed on the Intelligent function module utility setting screen, "\*" may be displayed for the model name.

This means that the required utility has not been installed or the utility cannot be started from GX Developer.

Check the required utility, selecting [Tools] - [Intelligent function utility] - [Utility list...] in GX Developer.



### 6.4 Initial Setting

**[Purpose]**

Make initial setting for operating the QD60P8-G for each channel.

There are the following setting items as the initial setting data (buffer memory).

- Comparison output selection
- Comparison output setting value
- Movement averaging processing selection
- Number of movement averaging processing
- Pre-scale function selection
- Pre-scale setting value
- Alarm output selection
- Alarm output setting value upper/upper limit
- Alarm output setting value upper/lower limit
- Alarm output setting value lower/upper limit
- Alarm output setting value lower/lower limit
- Count cycle change function selection
- Count cycle setting value

This initial setting makes sequence program setting unnecessary.

For more information on the setting details, refer to Section 3.4.2.

**[Operating procedure]**

"Start I/O No.\*" → "Module type" → "Module model name" → Initial setting

\* Enter the start I/O No. in hexadecimal.

**[Setting screen]**

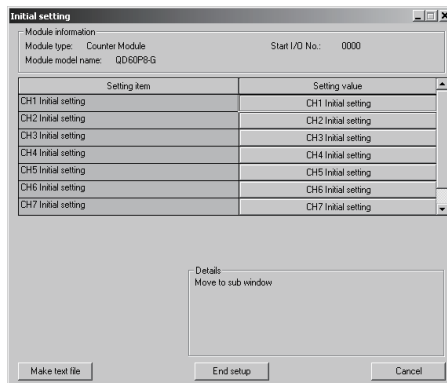

Move to sub window

CH1 Initial Setting

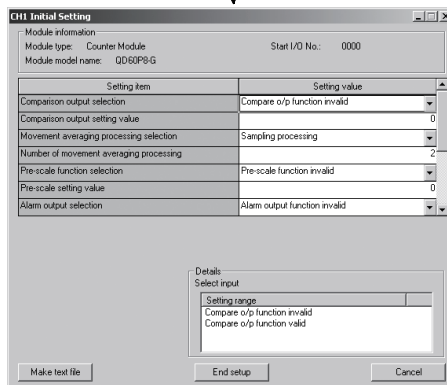

## [Explanation of items]

## (1) Command buttons

<input type="button" value="Make text file"/>	Creates a file containing the screen data in text file format.
<input type="button" value="End setup"/>	Saves the set data and ends the operation.
<input type="button" value="Cancel"/>	Cancels the setting and ends the operation.

**POINT**

Initial settings are stored in the intelligent function module parameter file.

After being written to the CPU module, the initial setting takes effect by either (1) or (2).

(1) Cycle the RUN/STOP switch of the CPU module: STOP → RUN → STOP → RUN.

(2) With the RUN/STOP switch set to RUN, turn off and then on the power or reset the CPU module.

Arrange so that the initial settings written by the sequence program are re-executed while the CPU module changes from STOP to RUN.

When using a sequence program, the initial setting parameters are written at the time the CPU module status changes from STOP to RUN.

### 6.5 Auto Refresh Setting

**[Purpose]**

Set the QD60P8-G buffer memory to be automatically refreshed, for each channel.

There are the following buffer memory items to be automatically refreshed for each channel.

- Sampling pulse number
- Comparison output selection
- Comparison output setting value
- Movement averaging processing selection
- Number of movement averaging processing
- Pre-scale function selection
- Pre-scale setting value
- Accumulating count value
- Input pulse value
- Overflow detection flag
- Counter reset request
- Carry over detection flag
- Carry over reset request
- Error code
- Alarm output selection
- Alarm output flag
- Alarm output setting value upper/upper limit
- Alarm output setting value upper/lower limit
- Alarm output setting value lower/upper limit
- Alarm output setting value lower/lower limit
- Count cycle change function selection
- Count cycle setting value

These auto refresh settings eliminate the need for reading by a sequence program.

**[Operating procedure]**

"Start I/O No.\*" → "Module type" → "Module model name" → Auto refresh

\* Enter the start I/O No. in hexadecimal.

**[Setting screen]**

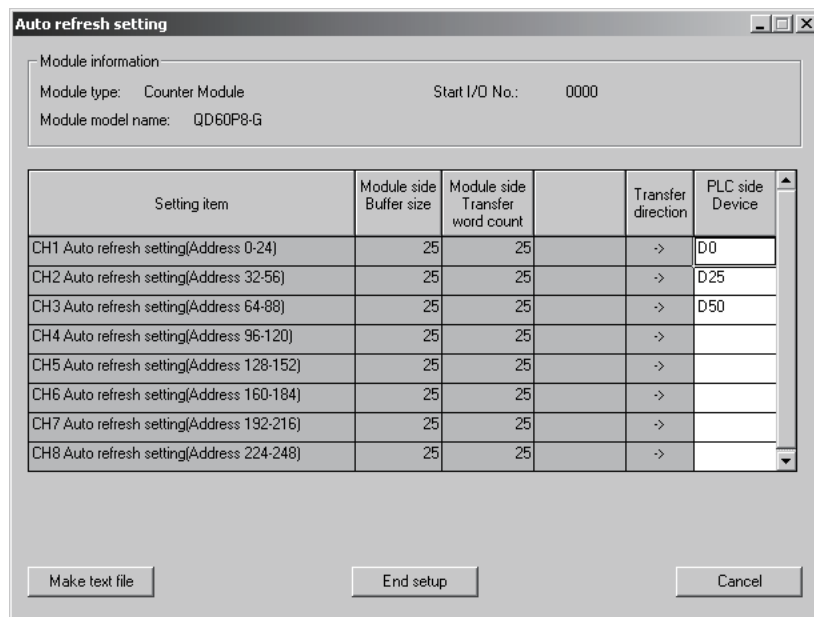

## [Explanation of items]

## (1) Items

Module side Buffer size : Displays the buffer memory size of the setting item.

Module side Transfer word count : Displays the number of words to be transferred.

Transfer direction : "←" indicates that data are written from the programmable controller CPU to the buffer memory.  
"→" indicates that data are loaded from the buffer memory to the programmable controller CPU.

PLC side Device : Enter a CPU module side device that is to be automatically refreshed.  
Applicable devices are X, Y, M, L, B, T, C, ST, D, W, R, and ZR.  
When using bit devices X, Y, M, L or B, set a number that can be divided by 16 points (examples: X10, Y120, M16, etc.)  
Also, buffer memory data are stored in a 16-point area, starting from the specified device number. For example, if X10 is entered, data are stored in X10 to X1F.

## (2) Command buttons

Creates a file containing the screen data in text file format.

Saves the set data and ends the operation.

Cancels the setting and ends the operation.

**POINT**

- At the time of auto refresh, the buffer memory contents are batch-read (25 words) for each channel. The order of storing the data into the CPU module side devices is the same as that of buffer memory assignment (refer to Section 3.4.1).
- The auto refresh settings are stored in an intelligent function module parameter file.  
The auto refresh settings become effective by turning the power off and then on or resetting the CPU module after writing the intelligent function module parameters to the CPU module.
- Auto refresh settings cannot be changed from the sequence program. However, it is possible to add a process similar to auto refresh by the sequence program.

### 6.6 Monitoring/Test

**[Purpose]**

Start buffer memory monitoring/testing and I/O signal monitoring/testing from this screen.

**[Operating procedure]**

"Select monitor/test module" screen → "Start I/O No. \*" → "Module type" →

"Module model name" → Monitor/test

\* Enter the start I/O No. in hexadecimal.

The screen can also be started from Counter System monitor of GX Developer Version 6 or later.

Refer to the GX Developer Operating Manual for details.

**[Setting screen]**

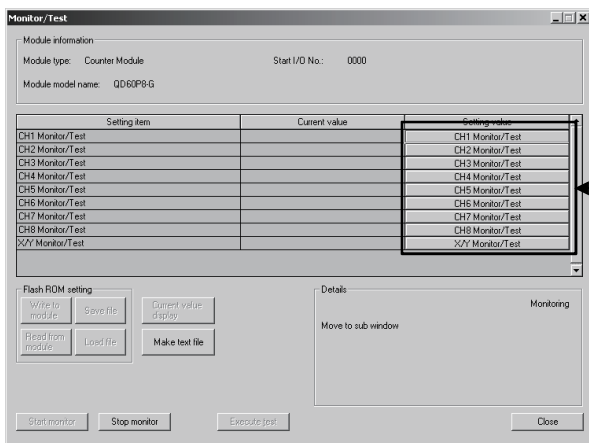

Selecting these buttons displays the following screens.

Move to sub window

X/T Monitor/Test

CH1 Monitor/Test

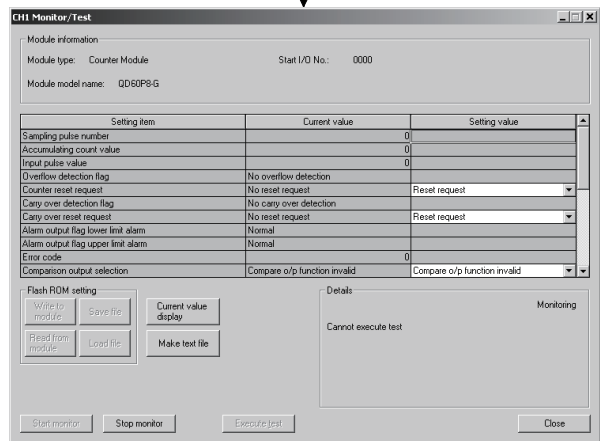
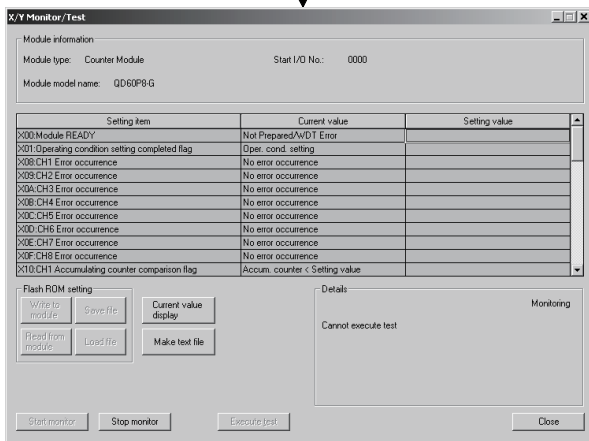

## [Explanation of items]

## (1) Items

Setting item : Displays I/O signals and buffer memory names.

Current value : Monitors the I/O signal states and present buffer memory values.

Setting value : Enter or select values to be written into the buffer memory for test operation.

## (2) Command buttons

Displays the current value of the item selected. (This is used to check the text that cannot be displayed in the current value field. However, in this utility package, all items can be displayed in the display fields).

Creates a file containing the screen data in text file format.

/

Selects whether or not to monitor current values.

Performs a test on the selected items. To select more than one item, select them while holding down the  key.

(Example)

Click this button after selecting "Error reset request" in the setting (value) field of "Error reset request" on the X/Y Monitor/Test screen.

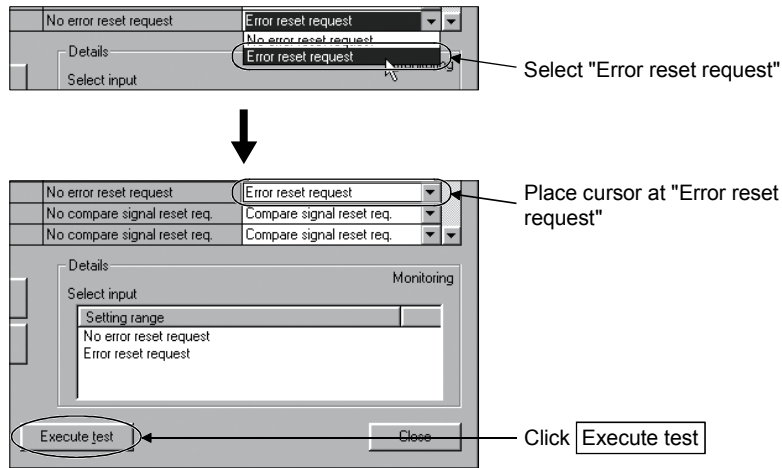

Perform similar operation also for the "Operating condition setting request flag".

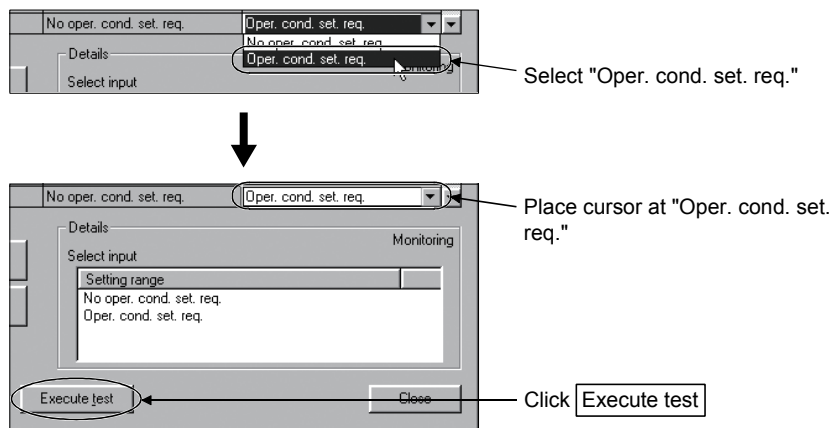

**Close**

Closes the screen that is currently open and returns to the previous screen.

**POINT**

- To reflect the new settings (values) on the module, you have to choose "Operating condition setting request" for the "Operating condition setting request flag" and click **Execute test**.
- "Error reset request"/"Comparison signal reset request" turns to "No request" automatically if Error occurrence (X8 to XF)/Accumulating counter comparison flag (X10 to X17) turns off at the time of test execution.

## CHAPTER 7 PROGRAMMING

This chapter describes a sequence program for use of the QD60P8-G.

When diverting the program example introduced in this chapter to the actual system, fully check that there are no problems in the controllability of the system.



7.1 Programming Procedure

This section explains the programming procedure for the QD60P8-G.  
 Create the program to start the count operation by turning on Count enable (Y18 to Y1F) on after the initial setting of the QD60P8-G in the following procedure.

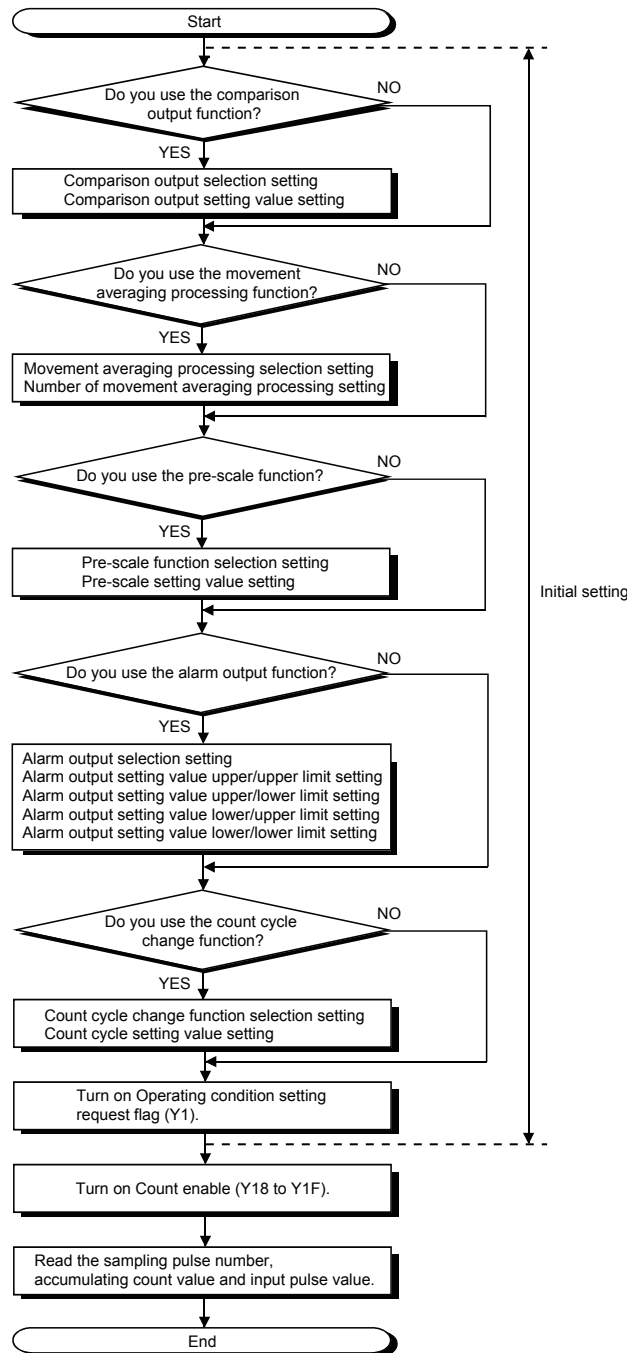

## 7.2 For Use in Normal System Configuration

## System configuration used in the program explanation

## (1) System configuration

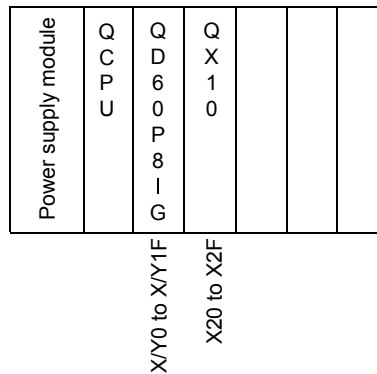

## (2) Program conditions

This program performs the count operation by turning on Count enable (Y18) on after the initial setting for CH1 of the QD60P8-G.

Set the input voltage selection, pulse edge selection, linear counter/ring counter selection and input filter setting using the intelligent function module switch of GX Developer. (Refer to Section 4.5.2 for details of setting the intelligent function module switch.)

- Input voltage selection : 12 to 24VDC
- Pulse edge selection : Rise edge
- Linear counter or Ring counter selection : Linear counter
- Input filter setting (CH1) : 30kpps

## 7.2.1 Program example using the utility package

## (1) List of devices to be used

In Section 7.2.1 (3) program example, the used devices are assigned as indicated in the following table.

In Section 7.2.1 (3) program example, the used devices to be used are assigned as indicated in the following table.

The I/O numbers for the QD60P8-G indicate those when the QD60P8-G is mounted on the 0-slot of the main base unit.

If it is mounted in the slot other than the 0-slot of the main base unit, change the I/O number to that for the position where the QD60P8-G was installed.

Change the external inputs, internal relays, and data registers according to the system to be used.

## Inputs/outputs, external inputs, and internal relays of the QD60P8-G

Device name		Device	Application
		CH1	
Input/output of the QD60P8-G	Inputs	X0	Module READY
		X1	Operating condition setting completed flag
		X8	Error occurrence
		X10	Accumulating counter comparison flag
	Outputs	Y8	Error reset request
		Y10	Comparison signal reset request
Y18		Count enable	
External input (command)		X21	Count enable on command
		X22	Count enable off command
		X23	Comparison signal reset command
		X24	Error reset command
		X25	Counter reset request command
		X26	Sampling pulse number read command
		X27	Accumulating count value read command
		X28	Input pulse value read command
Internal relay		M11	Overflow detection flag
		M30	Counter resetting
		M40	Carry over detection flag
		M60	Carry over resetting
		M80	Alarm output flag

## Data registers

Device name	Device	Device whose value is written in the auto refresh.	Data stored	
Data registers	D30	D0	Sampling pulse number	
	D31	D8	Accumulating count value	(L)
	D32	D9		(H)
	D33	D10	Input pulse value	(L)
	D34	D11		(H)
	D35	D16	Error code	

(2) GX Configurator-CT operation

(a) Initial setting (Refer to Section 6.4)  
Use channel 1.

- Comparison output selection : Compare o/p function valid
- Comparison output setting value : 500000
- Movement averaging processing selection : Movement avrg. processing
- Number of movement averaging processing : 10
- Pre-scale function selection : ×0.01
- Pre-scale setting value : 252
- Alarm output selection : Alarm output function valid
- Alarm output setting value upper/upper limit : 1100
- Alarm output setting value upper/lower limit : 1000
- Alarm output setting value lower/upper limit : 600
- Alarm output setting value lower/lower limit : 500

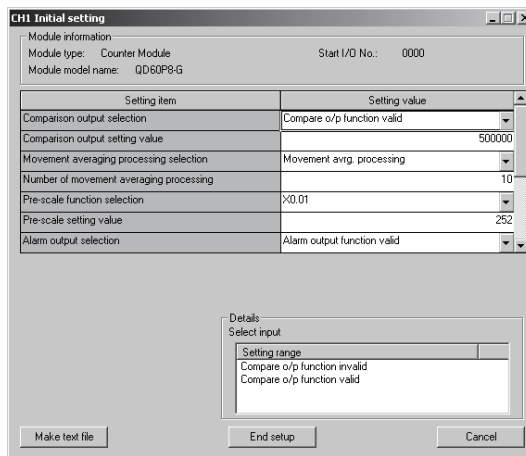

- (b) Auto refresh setting (Refer to Section 6.5)  
Set parameters as the following screen.

**Auto refresh setting**

Module information  
 Module type: Counter Module      Start I/O No.: 0000  
 Module model name: QD60P8-G

Setting item	Module side Buffer size	Module side Transfer word count	Transfer direction	PLC side Device
CH1 Auto refresh setting(Address 0-24)	25	25	->	D0
CH2 Auto refresh setting(Address 32-56)	25	25	->	
CH3 Auto refresh setting(Address 64-88)	25	25	->	
CH4 Auto refresh setting(Address 96-120)	25	25	->	
CH5 Auto refresh setting(Address 128-152)	25	25	->	
CH6 Auto refresh setting(Address 160-184)	25	25	->	
CH7 Auto refresh setting(Address 192-216)	25	25	->	
CH8 Auto refresh setting(Address 224-248)	25	25	->	

Make text file      End setup      Cancel

In this setting, the device of D0 to D24 correspond to buffer memory address Un\G0 to Un\G24.

- (c) Writing intelligent function module parameters (Refer to Section 6.3.3).  
Write the intelligent function module parameters to the CPU module.  
This operation is performed on the screen for selecting a parameter setting module.

(3) Program example

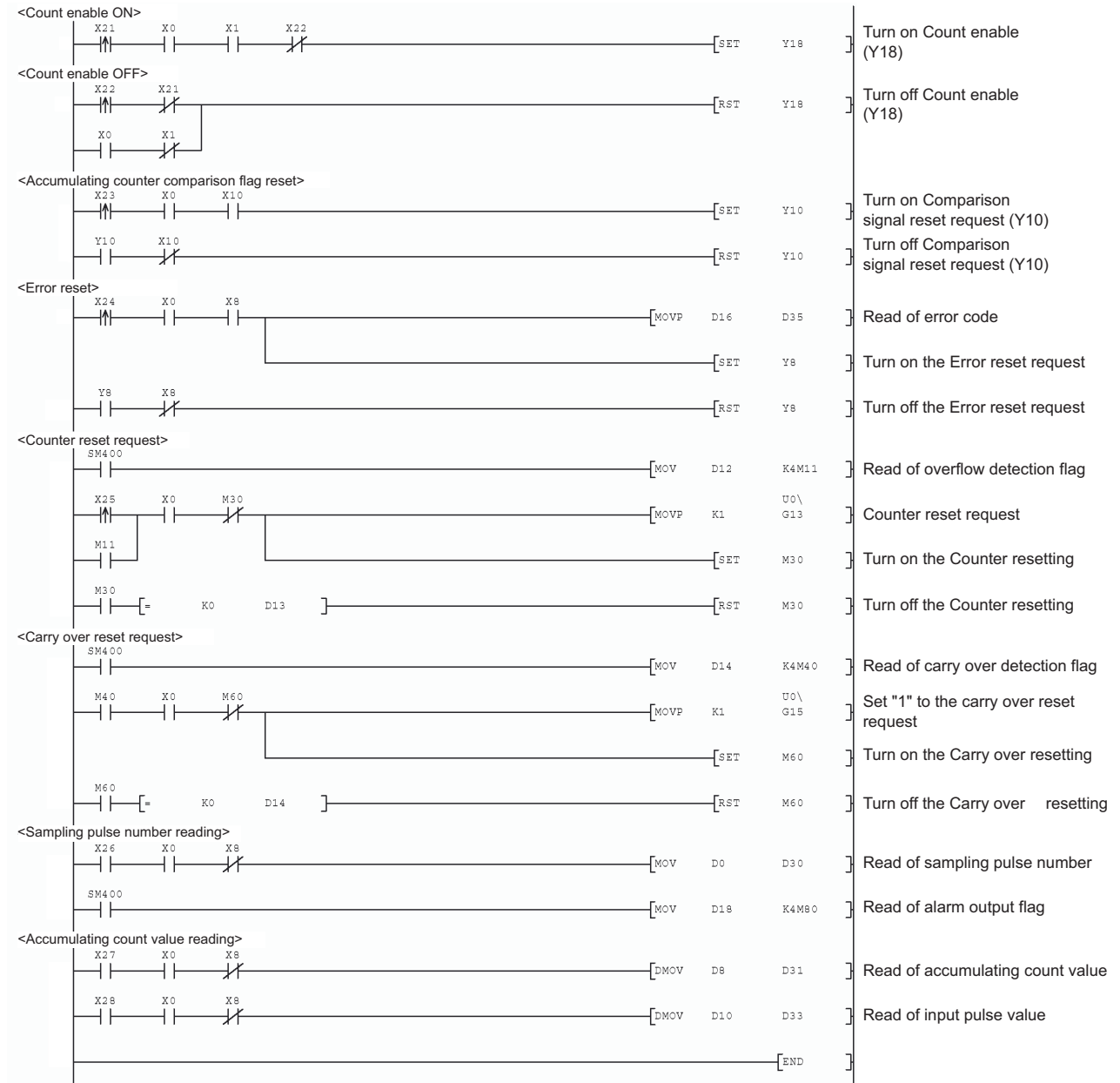

## 7.2.2 Program example without using the utility package

## (1) List of devices to be used

In Section 7.2.2 (2) program example, the devices to be used are assigned as indicated in the following table.

The I/O numbers for the QD60P8-G indicate those when the QD60P8-G is mounted on the 0-slot of the main base unit.

If it is mounted in the slot other than the 0-slot of the main base unit, change the I/O number to that for the position where the QD60P8-G was installed.

Change the external inputs, internal relays, and data registers, according to the system to be used.

## Inputs/outputs, external inputs, and internal relays of the QD60P8-G

Device name		Device	Application
		CH1	
Input/output of the QD60P8-G	Inputs	X0	Module READY
		X1	Operating condition setting completed flag
		X8	Error occurrence
		X10	Accumulating counter comparison flag
	Outputs	Y1	Operating condition setting request flag
		Y8	Error reset request
		Y10	Comparison signal reset request
External input (command)	Y18	Count enable	
	X20	Data setting command	
	X21	Count enable on command	
	X22	Count enable off command	
	X23	Comparison signal reset command	
	X24	Error reset command	
	X25	Counter reset request command	
	X26	Sampling pulse number read command	
X27	Accumulating count value read command		
Internal relay	X28	Input pulse value read command	
	M10	Data setting enable	
	M11	Overflow detection flag	
	M30	Counter resetting	
	M40	Carry over detection flag	
	M60	Carry over resetting	
M80	Alarm output flag		

## Data registers

Device name	Device	Buffer memory address	Data stored
Data registers	D30	0	Sampling pulse number
	D31	8	Accumulating count value
	D32	9	
	D33	10	Input pulse value
	D34	11	
	D35	16	Error code



(2) Program example

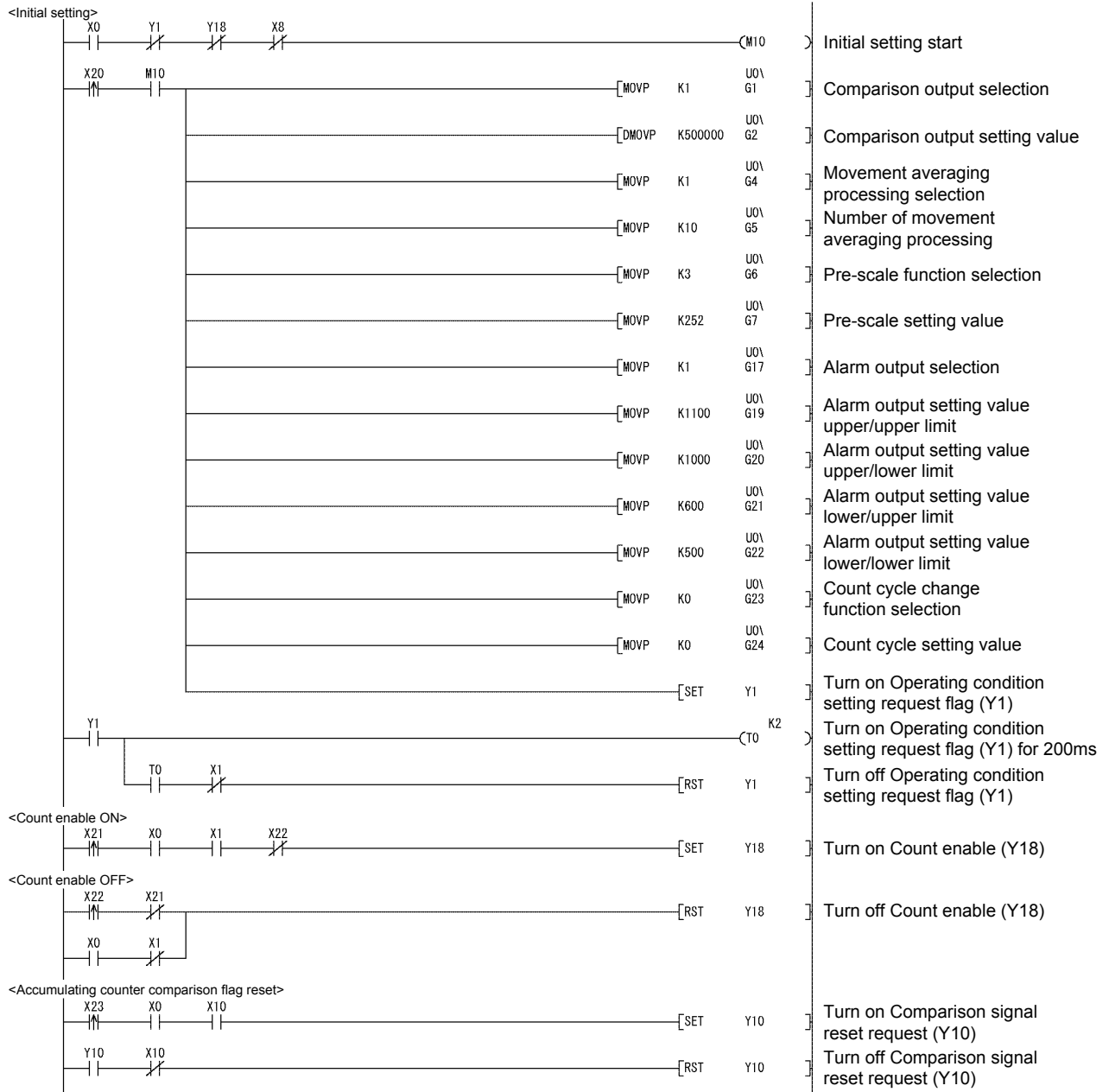

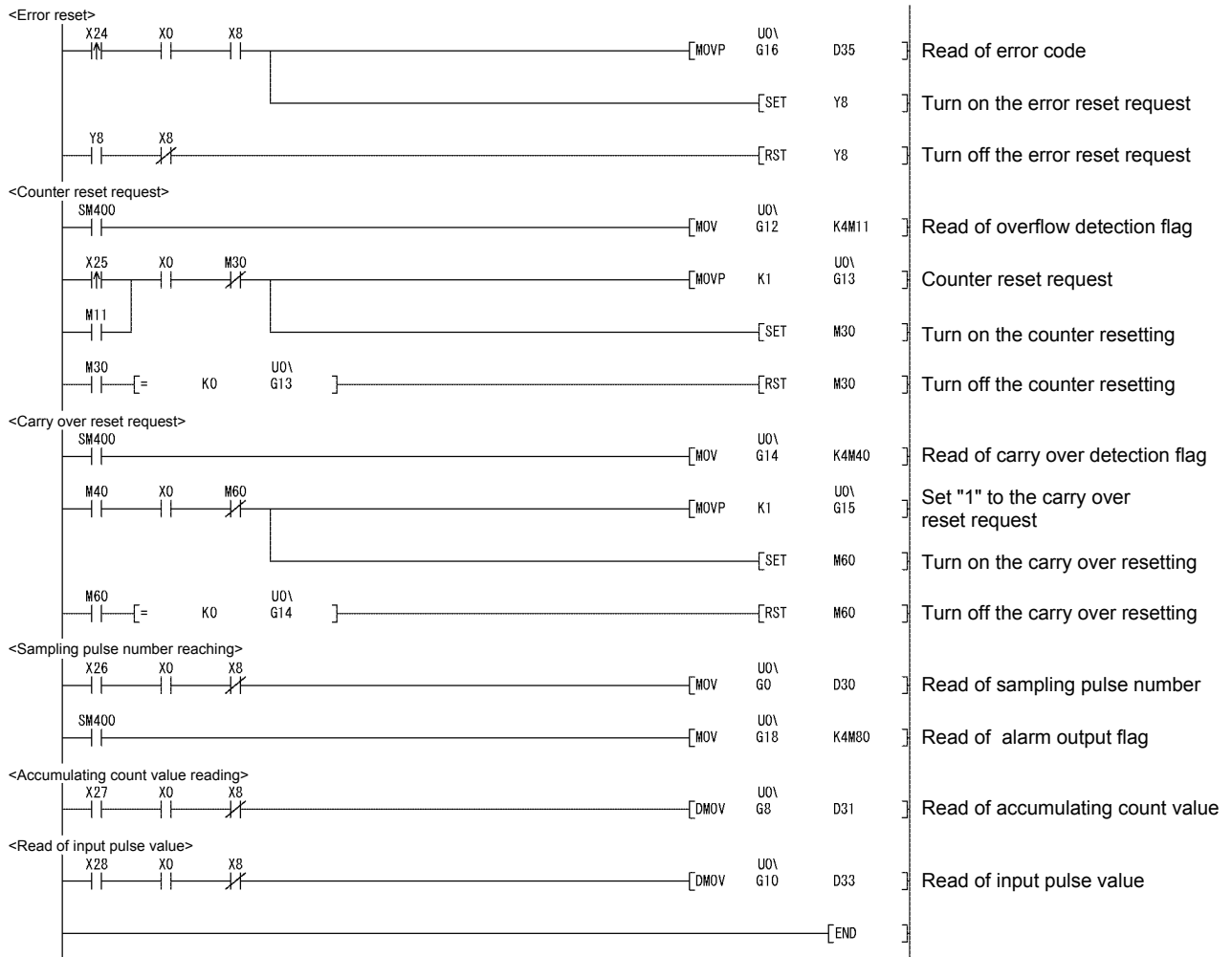

7.3 For Use on Remote I/O Network

System configuration used in the program explanation

(1) System configuration

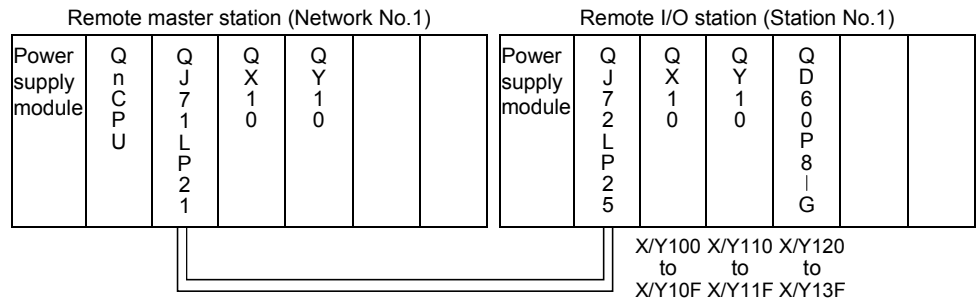

(2) Program conditions

This program starts the count operation by turning on Count enable (Y138) on after the initial setting for CH1 of the QD60P8-G.

Set the input voltage selection, pulse edge selection, linear counter/ring counter selection and input filter setting using the intelligent function module switch of GX Developer. (Refer to Section 4.5.2 for details of setting the intelligent function module switch.)

- Input voltage selection : 12 to 24VDC
- Pulse edge selection : Rise edge
- Linear counter or Ring counter selection : Linear counter
- Input filter setting (CH1) : 30kpps

7.3.1 Program example using the utility package

(1) Operation of GX Developer ("Network parameter" setting)

- Network type : MNET/H (remote master)
- Head I/O No. : 0000H
- Network No. : 1
- Total number of (slave) stations : 1
- Mode : Online
- Network range assignment :

StationNo.	M station -> R station			M station <- R station			M station -> R station			M station <- R station		
	Points	Start	End	Points	Start	End	Points	Start	End	Points	Start	End
1	256	0100	01FF	256	0000	00FF	256	0100	01FF	256	0000	00FF

- Refresh parameters :

	Link side					PLC side			
	Dev. name	Points	Start	End		Dev. name	Points	Start	End
Transfer SB	SB	512	0000	01FF	↔	SB	512	0000	01FF
Transfer SW	SW	512	0000	01FF	↔	SW	512	0000	01FF
Random cyclic	LB				↔				
Random cyclic	LW				↔				
Transfer1	LB	8192	0000	1FFF	↔	B	8192	0000	1FFF
Transfer2	LW	8192	0000	1FFF	↔	W	8192	0000	1FFF
Transfer3	LX	512	0000	01FF	↔	X	512	0000	01FF
Transfer4	LY	512	0000	01FF	↔	Y	512	0000	01FF
Transfer5					↔				
Transfer6					↔				

## (2) List of devices to be used

In Section 7.3.1 (4) program example, the devices to be used are assigned as indicated in the following table.

The I/O numbers for the QD60P8-G indicate those when the QD60P8-G is mounted on the 2-slot of the main base unit.

If it is mounted in the slot other than the 2-slot of the main base unit, change the I/O number to that for the position where the QD60P8-G was installed.

Change the external inputs, internal relays and data registers, according to the system to be used.

## Inputs/outputs, external inputs, and internal relays of the QD60P8-G

Device name		Device	Application
		CH1	
Input/output of the QD60P8-G	Inputs	X120	Module READY
		X121	Operating condition setting completed flag
		X128	Error occurrence
		X130	Accumulating counter comparison flag
	Outputs	Y128	Error reset request
		Y130	Comparison signal reset request
		Y138	Count enable
External input (command)		X21	Count enable on command
		X22	Count enable off command
		X23	Comparison signal reset command
		X24	Error reset command
		X25	Counter reset request command
		X26	Sampling pulse number read command
		X27	Accumulating count value read command
		X28	Input pulse value read command
Internal relay		M11	Overflow detection flag
		M30	Counter resetting
		M40	Carry over detection flag
		M60	Carry over resetting
		M80	Alarm output flag

## Data registers

Device name	Device	Device whose value is written in the auto refresh.	Data stored	
Data registers	D30	W0	Sampling pulse number	
	D31	W8	Accumulating count value	(L)
	D32	W9		(H)
	D33	W10	Input pulse value	(L)
	D34	W11		(H)
	D35	W16	Error code	

## (3) GX Configurator-CT operation

## (a) Initial setting (Refer to Section 6.4)

Use channel 1.

- Comparison output selection : Compare o/p function valid
- Comparison output setting value : 500000
- Movement averaging processing selection : Movement avrg. processing
- Number of movement averaging processing : 10
- Pre-scale function selection :  $\times 0.01$
- Pre-scale setting value : 252
- Alarm output selection : Alarm output function valid
- Alarm output setting value upper/upper limit : 1100
- Alarm output setting value upper/lower limit : 1000
- Alarm output setting value lower/upper limit : 600
- Alarm output setting value lower/lower limit : 500

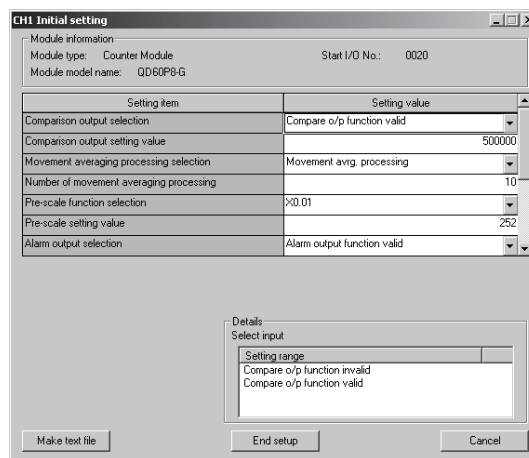

- (b) Auto refresh setting (Refer to Section 6.5)  
Set parameters as the following screen.

**Auto refresh setting**

Module information  
 Module type: Counter Module      Start I/O No.: 0020  
 Module model name: QD60P8-G

Setting item	Module side Buffer size	Module side Transfer word count	Transfer direction	PLC side Device
CH1 Auto refresh setting(Address 0-24)	25	25	->	W0
CH2 Auto refresh setting(Address 32-56)	25	25	->	
CH3 Auto refresh setting(Address 64-88)	25	25	->	
CH4 Auto refresh setting(Address 96-120)	25	25	->	
CH5 Auto refresh setting(Address 128-152)	25	25	->	
CH6 Auto refresh setting(Address 160-184)	25	25	->	
CH7 Auto refresh setting(Address 192-216)	25	25	->	
CH8 Auto refresh setting(Address 224-248)	25	25	->	

Make text file      End setup      Cancel

In this setting, the device of W0 to W24 correspond to buffer memory address Un\G0 to Un\G24.

- (c) Writing intelligent function module parameters (Refer to Section 6.3.3).  
Write the intelligent function module parameters to the remote I/O station.  
This operation is performed on the screen for selecting a parameter setting module.

(4) Program example

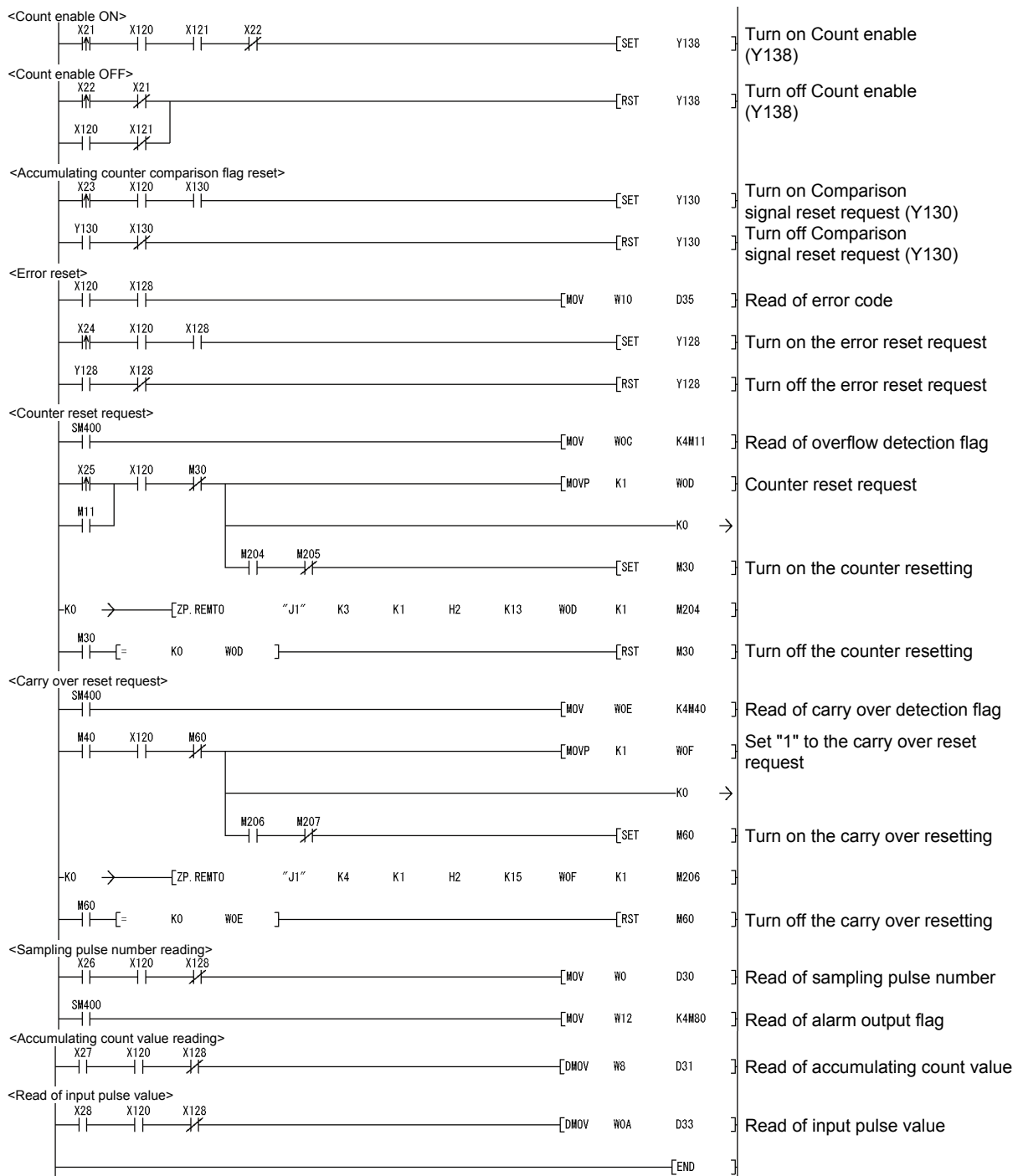



7.3.2 Program example without using the utility package

(1) Operation of GX Developer (Network parameter setting)

- Network type : MNET/H (remote master)
- Head I/O No. : 0000H
- Network No. : 1
- Total number of (slave) stations : 1
- Mode : Online
- Network range assignment :

StationNo.	M station -> R station						M station <- R station					
	Y			Y			X			X		
	Points	Start	End	Points	Start	End	Points	Start	End	Points	Start	End
1	256	0100	01FF	256	0000	00FF	256	0100	01FF	256	0000	00FF

- Refresh parameters :

	Link side					PLC side			
	Dev. name	Points	Start	End		Dev. name	Points	Start	End
Transfer SB	SB	512	0000	01FF	↔	SB	512	0000	01FF
Transfer SW	SW	512	0000	01FF	↔	SW	512	0000	01FF
Random cyclic	LB				↔				
Random cyclic	LW				↔				
Transfer1	LB	8192	0000	1FFF	↔	B	8192	0000	1FFF
Transfer2	LW	8192	0000	1FFF	↔	w	8192	0000	1FFF
Transfer3	LX	256	0100	01FF	↔	X	256	0100	01FF
Transfer4	LY	256	0100	01FF	↔	Y	256	0100	01FF
Transfer5					↔				
Transfer6					↔				

## (2) List of devices to be used

In Section 7.3.2 (3) program example, the devices to be used are assigned as indicated in the following table.

The I/O numbers for the QD60P8-G indicate those when the QD60P8-G is mounted on Slot 2 of the remote I/O station.

If it is mounted on the slot other than Slot 2 of the remote I/O station, change the I/O numbers to those for the position where the QD60P8-G was installed.

Change the external inputs, internal relays, and data registers according to the system to be used.

## Inputs/outputs, external inputs, and internal relays of the QD60P8-G

Device name		Device	Application
		CH1	
Input/output of QD60P8-G	Inputs	X120	Module READY
		X121	Operating condition setting complete flag
		X128	Error occurrence
		X130	Accumulating counter comparison flag
	Outputs	Y121	Operating condition setting request flag
		Y128	Error reset request
		Y130	Comparison signal reset request
		Y138	Count enable
External input (command)		X20	Data setting command
		X21	Count enable on command
		X22	Count enable off command
		X23	Comparison signal reset command
		X24	Error reset command
		X25	Counter reset request command
		X26	Sampling pulse number read command
		X27	Accumulating count value read command
Internal relay		M10	Data setting enable
		M11	Overflow detection flag
		M30	Counter resetting
		M40	Carry over detection flag
		M60	Carry over resetting
		M80	Alarm output flag

## Data registers

Device name	Device	Buffer memory address	Data stored	
Data registers	D30	0	Sampling pulse number	
	D31	8	Accumulating count value	(L)
	D32	9		(H)
	D33	10	Input pulse value	(L)
	D34	11		(H)
	D35	16	Error code	

(3) Program example

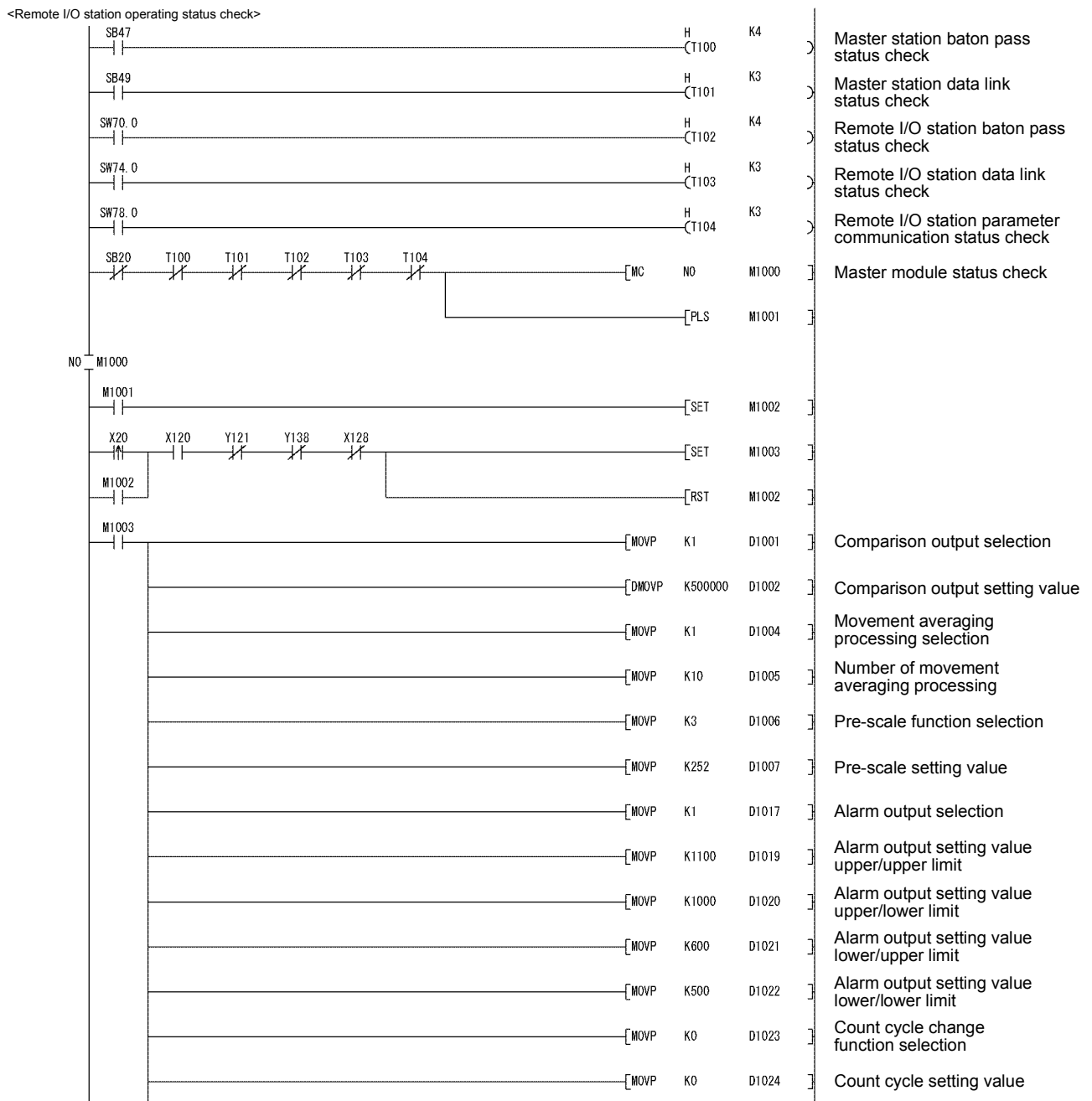

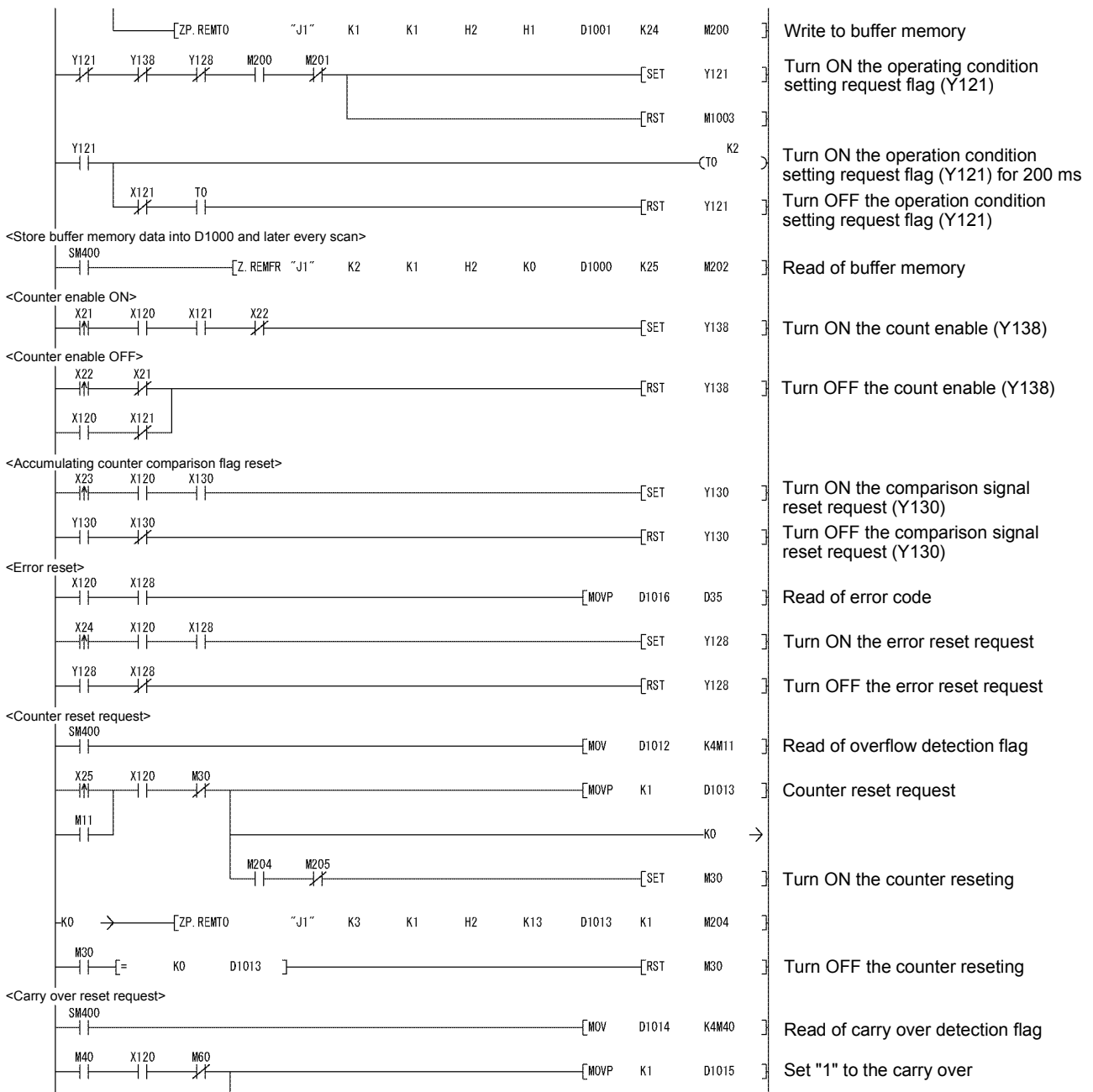

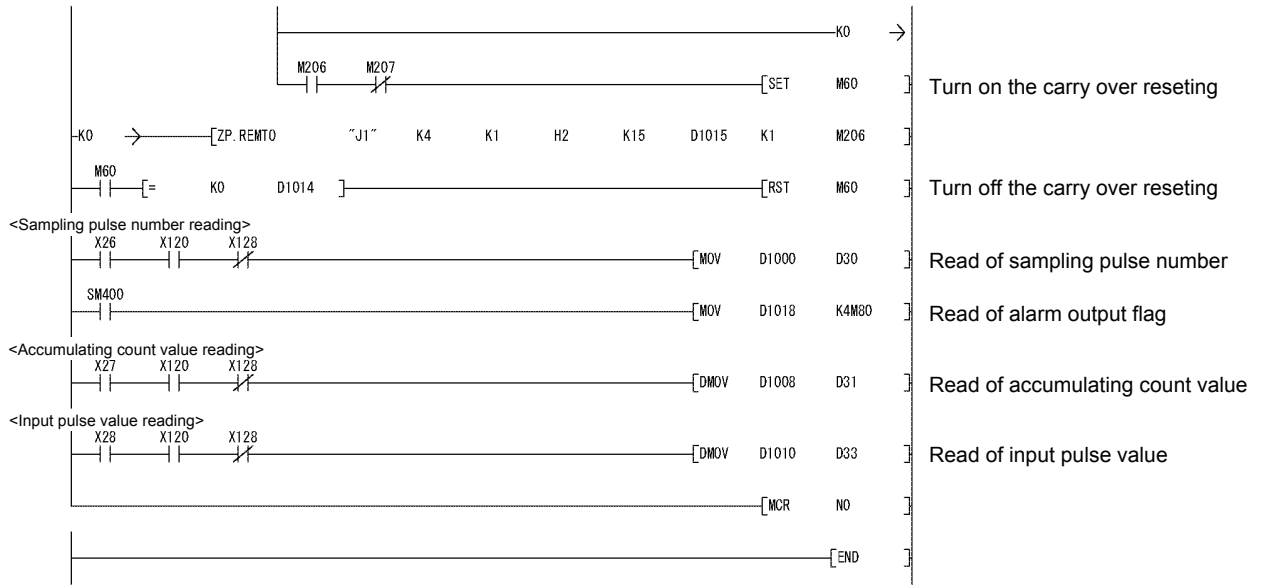

## CHAPTER 8 ONLINE MODULE CHANGE

When changing a module online, carefully read the QCPU User's Manual (Hardware Design, Maintenance and Inspection), section 12.4.1 "Online module change". This chapter describes the functions of an online module change. Perform an online module change by operating GX Developer.

POINT
(1) Perform an online module change after making sure that the system outside the programmable controller will not malfunction.
(2) To prevent an electric shock and malfunction of operating modules, provide means such as switches for powering off each of the external power supply and external devices connected to the module to be replaced online.
(3) To prevent an electric shock, always turn off the input pulse signal from the pulse generator connected to the module to be changed online.
(4) After the module has become faulty, the buffer memory contents cannot be confirmed. Therefore, prerecord the settings (The whole buffer memory contents that can be written refer to Section 3.4.1).
(5) It is recommended to perform an online module change in the actual system in advance to ensure that it would not affect the other modules by checking the following: <ul style="list-style-type: none"><li>• Means of cutting off the connection to external devices and its configuration are correct.</li><li>• Switching on/off does not bring any undesirable effect.</li></ul>
(6) Do not install/remove the module to/from the base unit, or the terminal block to/from the module more than 50 times after the first use of the product. (IEC 61131-2 compliant) Failure to do so may cause malfunction.

## 8.1 Online Module Change Conditions

The programmable controller CPU, MELSECNET/H remote I/O module, GX Developer and base unit given below are needed to perform an online module change.

### (1) Programmable controller CPU

The Process CPU or Redundant CPU are required.

For precautions for multiple CPU system configuration, refer to the QCPU User's Manual (Multiple CPU System).

For precautions for redundant system configuration, refer to the QnPRHCPU User's Manual (Redundant System).

### (2) MELSECNET/H remote I/O module

The module of function version D or later is necessary.

### (3) GX Developer

GX Developer of Version 7.10L or later is necessary.

GX Developer of Version 8.18U or later is required to perform an online module change on the remote I/O station.

### (4) Base unit

1) When the slim type main base unit (Q3□SB) is used, an online module change cannot be performed.

2) When the power supply module unnecessary type extension base unit (Q5□B) is used, online module change cannot be performed for the modules on all the base units connected.

8.2 Online Module Change Operations

The following gives the operations performed for an online module change.

No.*3	Programmable controller CPU operation ○: Executed ×: Not executed					(User operation) * 3	(Intelligent function module operation)
	X/Y refresh	FROM/TO instruction *1	Device test	GX Configurator-CT			
				Initial setting parameter	Monitor/test		
(1)	○	○	○	×	○	(1) Operation stop Turn off all Y signals that were turned on by a sequence program.	Module is operating.
(2)	×	×	×	×	×	(2) Dismounting of module Operate GX Developer to start an online module change. Click the [Execution] button of GX Developer to make the module dismountable. Dismount the corresponding module (QD60P8-G).	Module stops operating. • RUN LED turns off.
(3)	○	×	×	○	×	(3) Mounting of new module Mount a new module (QD60P8-G). After mounting the module, click the [Execution] button of GX Developer.	X/Y refresh resumes and the module starts. • RUN LED turns on. • Default operation (X0 remains off) (When there are initial setting parameters, operation is performed according to the initial setting parameters at this point.)
(4)	○	×	○	×	○	(4) Operation check Click the [Cancel] button of GX Developer to leave the online mode. Conduct an operation test on the new module using "Device test" of GX Developer "Monitor/test" of GX Configurator-CT.	Module operates according to test operation *2
(5)	○	○	○	×	○	(5) Resumption of control Operate GX Developer to resume the online module change mode, and click the [Execution] button to resume control.	X0 (Module READY) turns on. Start is made when X0 turns from off to on. Operation is performed according to the initial setting sequence.*2

\*1: Access to the intelligent function module device (U□\G□) is included.

\*2: In the absence of the operation marked \*2, the operation of the intelligent function module is the operation performed prior to that.

\*3: The item numbers (1) to (5) correspond to the operation step numbers of "Section 8.3 Online module change procedure".



### 8.3 Online Module Change Procedure

The online module change procedure is explained separately for the case where GX Configurator-CT was used for initial setting and for the case where a sequence program was used for initial setting.

#### 8.3.1 GX Configurator-CT was used for initial setting

##### (1) Operation stop

Turn off all output signals (Y devices) from the sequence program or the device test of GX Developer to stop the module operation.

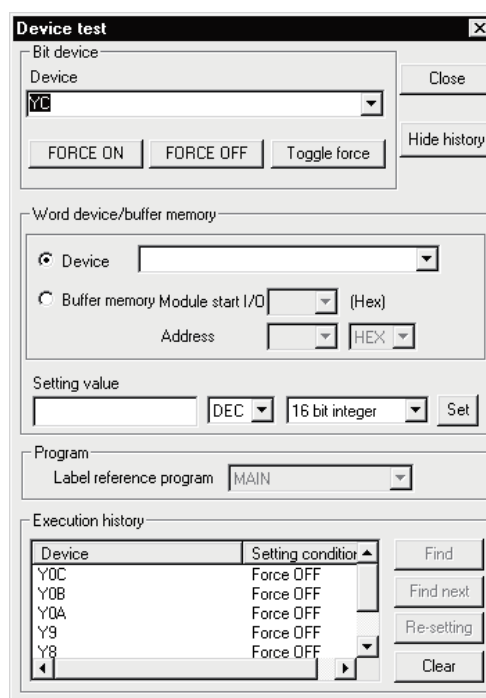

(2) Dismounting of module

- (a) After choosing [Diagnosis] - [Online module change] on GX Developer to enter the "Online module change" mode, double-click the module to be changed online to display the "Online module change" screen.

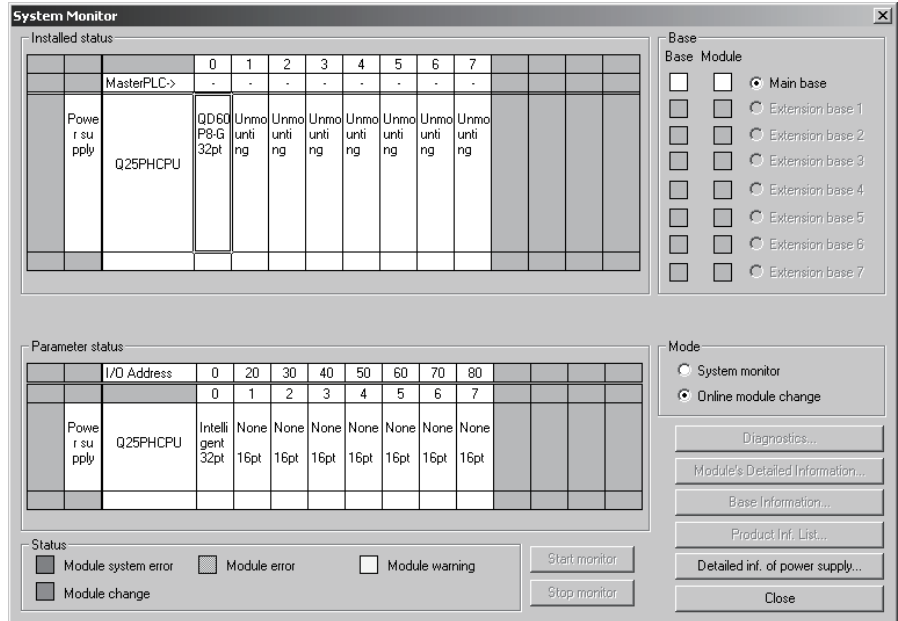

- (b) Click the "Execution" button to enable a module change.

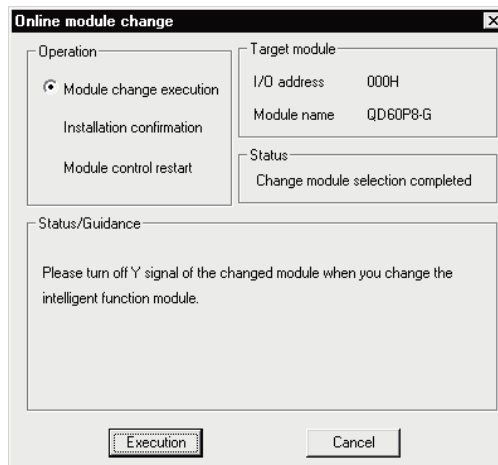

If the following error screen appears, click the "OK" button and perform the operation in (2)(c) and later.



- (c) After confirming that the "RUN" LED of the module has turned off, disconnect the external wiring and dismount the module.

<b>POINT</b>
Always dismount the module. If mounting confirmation is made without the module being dismounted, the module will not start properly and the "RUN" LED will not be lit.

## (3) Mounting of new module

- (a) Mount a new module to the same slot and connect the external wiring.
- (b) After mounting the module, click the [Execution] button and make sure that the "RUN" LED is lit. Module READY (X0) remains off.

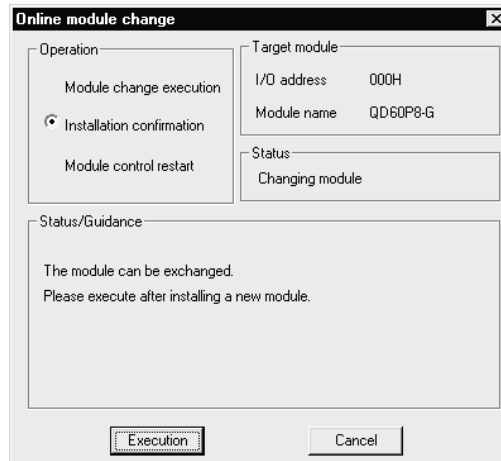

## (4) Operation check

- (a) When making an operation check, click the [Cancel] button to cancel control resumption.

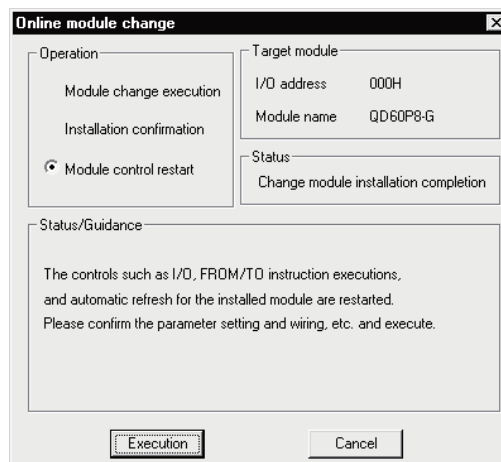

- (b) Click the [OK] button to leave the "Online module change" mode.

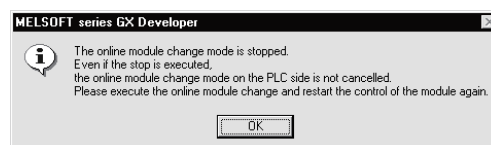

(c) Click the [Close] button to close the System monitor screen.

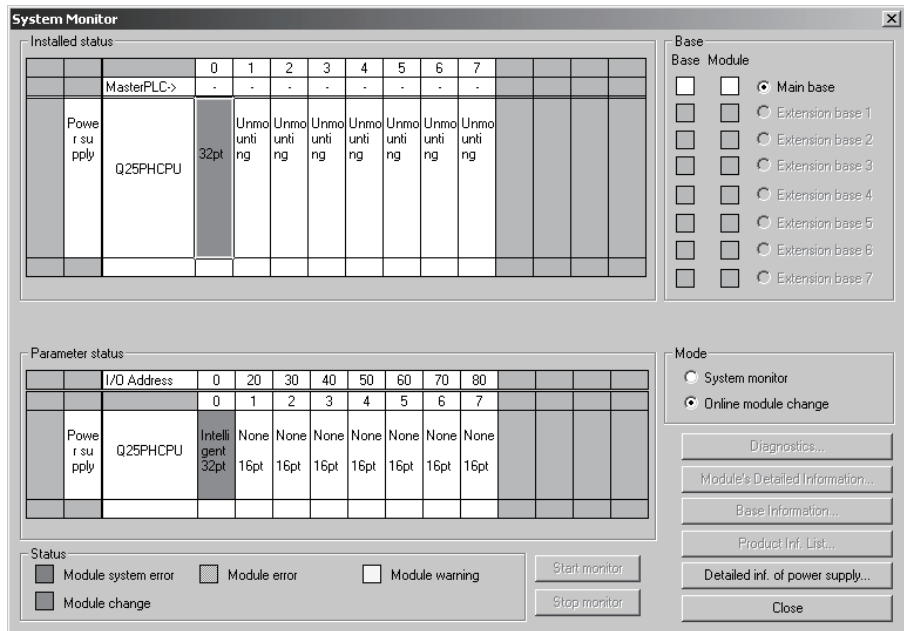

(5) Resumption of control

(a) After choosing [Diagnostics] - [Online module change] on GX Developer to redisplay the "Online module change" screen, click the [Execution] button to resume control. The FROM/TO instruction for the module resumes.

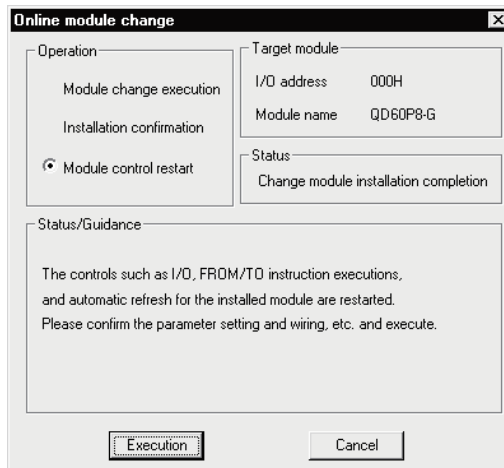

(b) The "Online module change completed" screen appears.



## 8.3.2 Sequence program was used for initial setting

## (1) Operation stop

- (a) Turn off all output signals (Y devices) from the sequence program or the device test of GX Developer to stop the module operation.

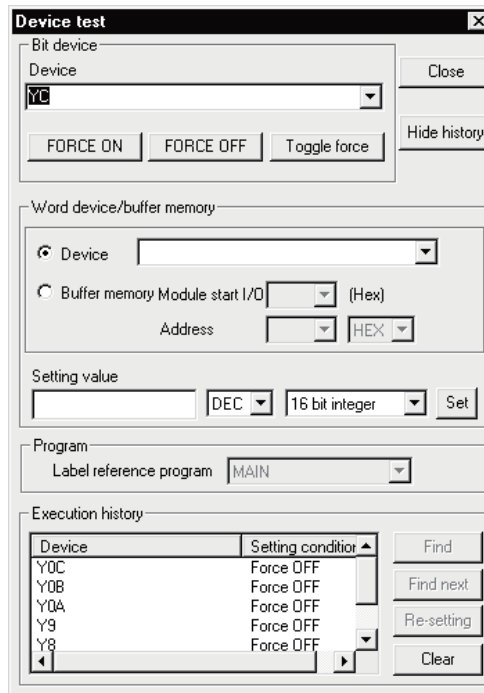

- (b) Prerecord the writable buffer memory contents that have been set initially in the sequence program.

Choose [Online] - [Monitor] - [Buffer memory batch] on GX Developer, monitor the buffer memory, and record the values.

**POINT**

If a CPU continuation error (e.g. SP. UNIT DOWN, UNIT VERIFY ERR.) has occurred due to the fault of the module to be changed, the buffer memory contents cannot be confirmed.

(2) Dismounting of module

- (a) After choosing [Diagnosis] - [Online module change] on GX Developer to enter the "Online module change" mode, double-click the module to be changed online to display the "Online module change" screen.

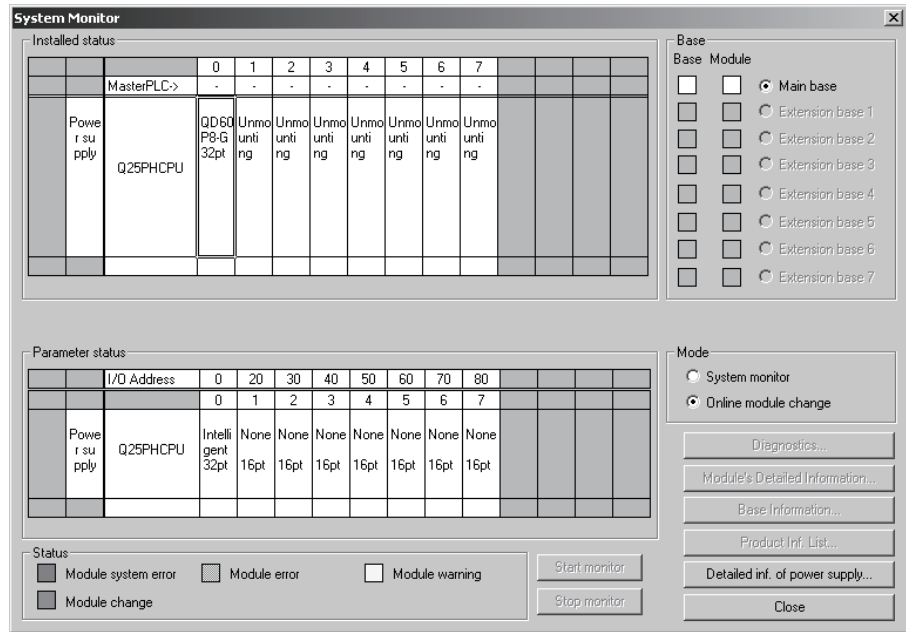

- (b) Click the "Execution" button to enable a module change.

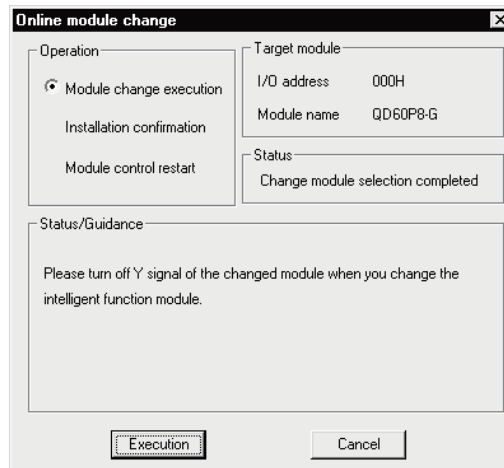

If the following error screen appears, click the [OK] button and perform the operation in (2) (c) and later.



- (c) After confirming that the "RUN" LED of the module has turned off, disconnect the external wiring and dismount the module.

<b>POINT</b>
--------------

<p>Always dismount the module. If mounting confirmation is made without the module being dismounted, the module will not start properly and the "RUN" LED will not be lit.</p>
--

### (3) Mounting of new module

- (a) Mount a new module to the same slot and connect the external wiring.
- (b) After mounting the module, click the [Execution] button and make sure that the "RUN" LED is lit. Module READY (X0) remains off.

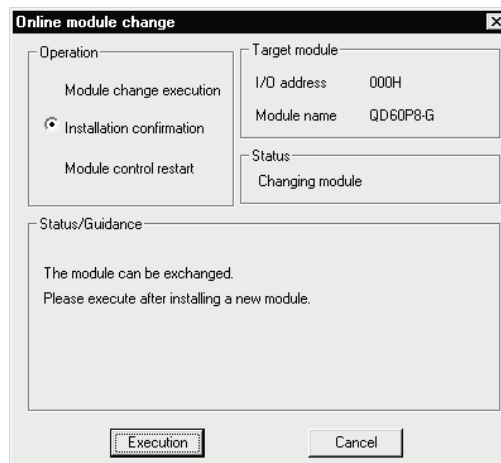

### (4) Operation check

- (a) To make an operation check, click the [Cancel] button to cancel control resumption.

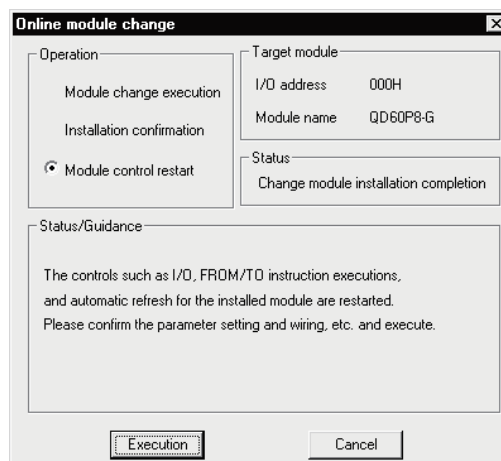

- (b) Click the [OK] button to leave the "Online module change" mode.

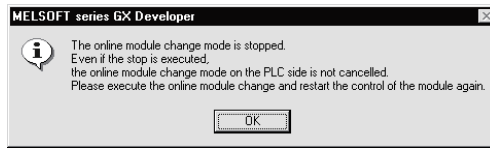

- (c) Click the [Close] button to close the System monitor screen.

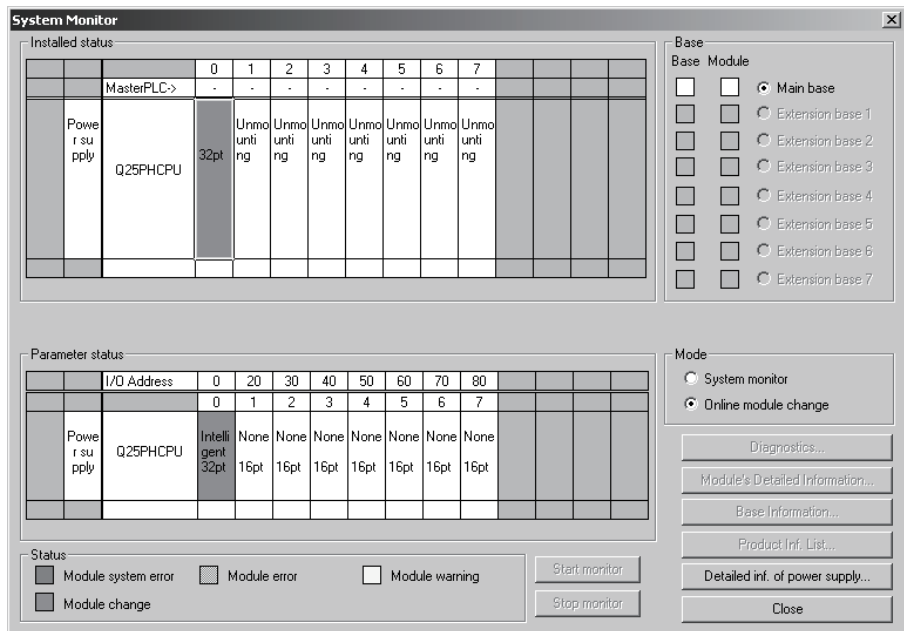

- (d) Choose [Online] - [Debug] - [Device test] on GX Developer, and set the buffer memory contents recorded in step (1)(b) to the buffer memory.
- (e) Since the new module is in a default status, it must be initialized by a sequence program after control resumption. Before performing initialization, check whether the contents of the initialization program are correct or not.
  - 1) Normal system configuration
 

The sequence program should perform initialization on the leading edge of Module READY (X0) of the QD60P8-G.

When control resumption is executed, Module READY (X0) turns on and initialization is performed. (If the sequence program performs initialization only one scan after RUN, initialization is not performed.)
  - 2) When used on remote I/O network
 

Insert a user device that will execute initialization at any timing (initialization request signal) into the sequence program. After control resumption, turn on the initialization request signal to perform initialization. (If the sequence program performs initialization only for one scan after entering the RUN status, initialization is not performed.)



## (5) Resumption of control

- (a) After choosing [Diagnostics] - [Online module change] on GX Developer to redisplay the "Online module change" screen, click the [Execution] button to resume control. The FROM/TO instruction for the module resumes.

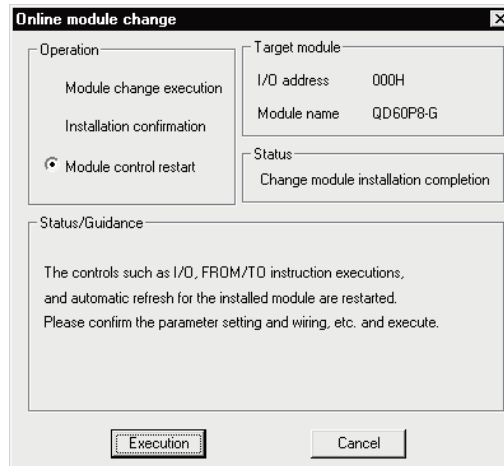

- (b) The "Online module change completed" screen appears.



## 8.4 Precautions for Online Module Change

The following are the precautions for online module change.

- (1) Always perform an online module change in the correct procedure. A failure to do so can cause a malfunction or failure.
- (2) When an online module change is made, the following buffer memory values are cleared to "0".
  - Sampling pulse number
  - Accumulating count value
  - Input pulse value

## CHAPTER 9 TROUBLESHOOTING

## 9.1 Troubleshooting

This section explains the troubleshooting for the cases where the count of input pulses cannot be started and the input pulse count value is incorrect during use of the QD60P8-G.

## (1) When the RUN LED is turned off

Check item	Corrective action
Is the power being supplied?	Confirm that the supply voltage for the power supply module is within the rated range.
Is the capacity of the power supply module adequate?	Calculate the current consumption of the CPU module, I/O module and intelligent function module mounted on the base unit to see if the power supply capacity is adequate.
Has a watch dog timer error occurred?	Reset the programmable controller CPU and verify that it is lit. If the RUN LED does not light even after doing this, the module may be malfunctioning. Contact the nearest branch office or agency with a details of the occurring problem.
Is the module correctly mounted on the base unit?	Check the mounting condition of the module.
Is a module change enabled during an online module change?	Refer to Chapter 8 and take corrective action.

## (2) When the "ERR." LED is turned on

Check item	Corrective action
Is an error being generated?	Confirm Error code and take corrective action described in Section 9.3.

## (3) When count cannot be started or normal count cannot be made

Check item		Corrective action
Is the terminal block external wiring normal?		Refer to Section 3.5, and check and correct the external wiring.
Noise preventive measure	Does the pulse input wiring use a shielded twisted pair cable?	Use a shielded twisted pair cable for the pulse input wiring.
	Is noise entering from the module grounding section?	Separate the module's ground cable. If the module's case is contacting the grounding section, detach it.
	Have noise preventive measures been taken inside the panel and for adjacent equipment?	Take noise preventative measures such as attaching a CR surge suppressor to a magnet switch.
	Is there sufficient clearance between high voltage equipment and pulse input lines?	Wire the pulse input line independently inside the panel, separate the pulse input line from the power line by at least 150 mm (5.9 in) as a guideline.
Is the "CH□" LED lit when a voltage is applied to the pulse input terminal by a stabilized power supply or similar?		If the LED lights up, check the external wiring and the pulse generator side and make necessary corrections. If the LED is not lit, the possible cause of a module fault. Contact the nearest branch office or agency with a details of the occurring problem.
Does the "input voltage selection" in setting with the intelligent function module switch match the actual input pulse voltage.		Correct the "input voltage selection" in setting with the intelligent function module.
Is the edge (rise/fall) of the counted pulses correct?		Check whether pulses are counted on the rise or fall, and correct the "pulse edge selection" in setting with the intelligent function module.
Is the maximum speed of input pulses within the range of the counting speed set to the "input filter setting" in setting with the intelligent function module?		Correct the "input filter setting" in setting with the intelligent function module to match the maximum speed of input pulses.
Does the input pulse waveform satisfy the performance specifications?		Observe and check the pulse waveform with a synchroscope or similar, and if the input pulses do not satisfy the performance specifications, enter the input pulses that satisfy the performance specifications.
If "Accumulating count value" or "Input pulse value" of the buffer memory read on a two-word (32-bit) unit when it is read in the sequence program?		Read two words together.
Are the count values on multiple channels the same when the same pulse is input to the multiple channels?		If the count values are different, the possible cause is a module fault. Contact the nearest branch office or agency with a details of the occurring problem.
Is Count enable (Y18 to Y1F) on?		Turn Count enable (Y18 to Y1F) on using a sequence program.
Is "Overflow detection flag" of the buffer memory* "1"?		Set "1" in the "Counter reset request" of the buffer memory* to reset the counter.
Is "Pre-scale setting value" of the buffer memory* "0"?		Set a value other than "0" in "Pre-scale setting value" of the buffer memory*.

\*: Refer to Section 3.4 for details of the buffer memory.

9.1.1 Confirming the error definitions using system monitor of GX Developer

Choosing Module's detailed information in the system monitor of GX Developer allows you to confirm Error code.

(1) Operation of GX Developer

Choose [Diagnostics] → [System monitor] → "QD60P8-G module" and choose Module's Detailed Information.

(2) Confirmation of Error code

Error code appears in the latest error code field.

(By pressing the Error History button, the definition shown as the latest error code appears at No. 1.)

**Module's Detailed Information**

Module Name: QD60P8-G    Product information: 10111000000000 - C  
 I/O Address: 0  
 Implementation Position: Main Base 0Slot

Module Information

Module access	Possible	I/O Clear / Hold Settings	----
Fuse Status	---	Noise Filter Setting	----
Status of I/O Address Verify	Agree	Input Type	----
		Remote password setting status	----

Error Display

No.	Error Code
1	1300

Present Error: 300

Display format:  HEX  DEC

The display sequence of the error history is from the oldest error. The latest error is displayed in the line as under.

Error contents - Disposal

Contents: Movement averaging setting range outside error  
 The value set in the 'movement averaging processing selection' or 'number of movement averaging processing' of the buffer memory is outside the setting

Disposal: Turn ON the error reset request (Y8) of the CH1. After this, set a correct value and then turn ON the operating condition setting request flag (Y1).

Buttons: H/W Information... Start monitor Stop monitor Close

Annotations:

- [Error display details] points to the error table.
- [Error code of CHn (1 ≤ n ≤ 8)] points to the 'Error Code' column.
- [Display format] points to the 'DEC' radio button. Select "Decimal". (The error codes indicated in "Section 9.3 List of errors" are in decimal.)
- [Present Error] points to the '300' value. Means error code 300 "Movement averaging setting range outside error".

(3) Confirmation of Module's detailed information

Check the module information, the LED statuses, and the statuses of setting with the intelligent function module from "H/W Information" of Module's detailed information that can be displayed on the system monitor of GX Developer (Version 7.17T or later).

[Setting procedure]

Chose [Diagnostics] → [System monitor] → "QD60P8-G module" and choose "Module's Detailed Information" → H/W Information.

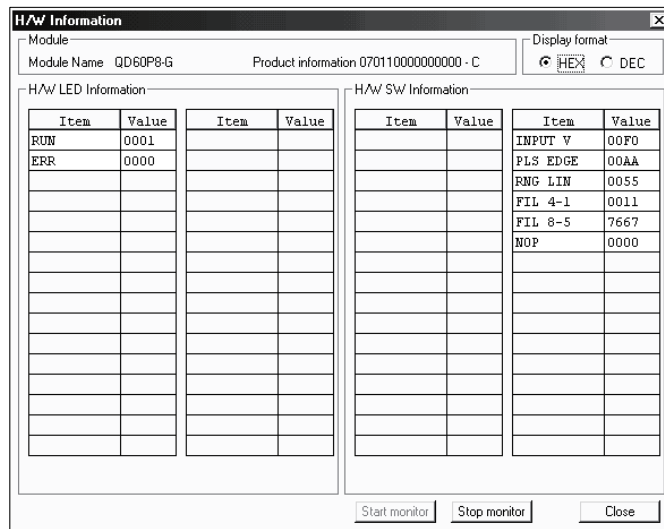

[H/W LED Information]

H/W LED information displays the following information.

Item	Signal name	Value
RUN	"RUN" LED of the QD60P8-G	0: LED off
ERR	"ERR." LED of the QD60P8-G	1: LED on

[H/W SW Information]

The setting status of the intelligent function module switches are displayed.

Item	Signal name	Corresponding switch	Value	
INPUT V	Input voltage selection	Switch 1	For details, refer to "Section 4.5.2 Switch setting for intelligent function module".	
PLS EDGE	Pulse edge selection	Switch 2		Lower 8 bits
RNG LIN	Linear counter or Ring counter selection			Upper 8 bits
FIL 4-1	Input filter setting (CH1 to CH4)	Switch 3		
FIL 8-5	Input filter setting (CH5 to CH8)	Switch 4		
NOP	—	Switch 5		

## 9.2 Error Details

### (1) Types of errors

The following errors are detected by the QD60P8-G.

#### (a) Overflow error

This error occurs if Accumulating count value overflows (exceeds 99999999) when the count type of the accumulating counter is the linear counter.

To clear this error, turn on Error reset request (Y8 to YF). Further, to start count operation properly, set "1" in the "Counter reset request" of the buffer memory.

#### (b) Buffer memory setting range outside error

This error occurs if any setting error is found by a check made on the values set to the buffer memory when Operating condition setting request flag (Y1) turns on. It occurs if any setting value in "Comparison output setting value" or similar of the buffer memory is outside the range.

To clear this error, set a correct value and turn on the operating condition setting request flag (Y1) again.

#### (c) Intelligent function module switch setting error

This error occurs if any setting error is found by a check made on the setting values of the switch settings for intelligent function module set in the PLC parameter when power is switched from off to on or the programmable controller CPU is reset.

To clear this error, set a correct value on GX Developer, perform write to PLC, and then switch power from off to on or reset the programmable controller CPU.

#### (d) Module error

This error occurs if a fault occurs in the module for some reason.

Change the module if the error occurs again after power is switched from off to on or the programmable controller CPU is reset.

**(2) Error storage**

If any of the settings made in the buffer memory or the setting with the intelligent function module is outside the setting range, Error occurrence (X8 to XF) turns on and Error code corresponding to the error definition is stored into the buffer memory.

By checking "Error code" of the buffer memory, the error cause can be identified.

CH	X/Y device		Buffer memory address of Error code
	Error occurrence	Error reset request	
1	X8	Y8	16
2	X9	Y9	48
3	XA	YA	80
4	XB	YB	112
5	XC	YC	144
6	XD	YD	176
7	XE	YE	208
8	XF	YF	240

**(3) Confirmation of error definitions**

GX Developer or GX Configurator-CT is required to check the error definition.

For details of how to check the error definition, refer to "Section 9.1.1 Confirming the error definitions using system monitor of GX Developer" or "Chapter 6 Utility Package (GX Configurator-CT)". (Refer to Section 9.3 for details of Error code.)





## 9.3 List of Errors

The following table shows the error details and remedies to be taken when an error occurs.

Error code	Error name	Error	Operation status at error occurrence
000	Normal status	—	—
100	Overflow error	When the linear counter was selected, Accumulating count value exceeded 99999999.	Count operation is stopped.
200	Comparison output setting range outside error	The value set in "Comparison output selection" or "Comparison output setting value" of the buffer memory is outside the setting range.	Count operation cannot be started.
300	Movement averaging setting range outside error	The value set in "Movement averaging processing selection" or "Number of movement averaging processing" of the buffer memory is outside the setting range.	
400	Pre-scale setting range outside error	The value set in "Pre-scale function selection" or "Pre-scale setting value" of the buffer memory is outside the setting range.	
500	Alarm output setting range outside error	<ul style="list-style-type: none"> <li>• The value set in "Alarm output selection", "Alarm output setting value upper/upper limit", "Alarm output setting value upper/lower limit", "Alarm output setting value lower/upper limit", or "Alarm output setting value lower/lower limit" of the buffer memory is outside the setting range.</li> <li>• The upper and lower relationships between the "alarm output setting values" of the buffer memory are illegal.</li> </ul>	
600	Count cycle setting range outside error	The value set in "Count cycle change function selection" or "Count cycle setting value" of the buffer memory is outside the setting range.	

Related buffer memory address								Setting range	Remedy
CH1	CH2	CH3	CH4	CH5	CH6	CH7	CH8		
–	–	–	–	–	–	–	–	–	–
Accumulating count value								–	Set "1" in the "counter reset request" of the buffer memory to reset the accumulating count value. (This error is cleared when Error reset request (Y8 to YF) turns on but requires the counter to be reset to perform count operation.)
8	40	72	104	136	168	200	232		
9	41	73	105	137	169	201	233		
Counter reset request								1: Reset request (The value automatically turns to "0" after completion of a counter reset.)	
13	45	77	109	141	173	205	237		
Comparison output selection								0: Comparison output function invalid 1: Comparison output function valid	
1	33	65	97	129	161	193	225		
Comparison output setting value								0 to 99999999	
2	34	66	98	130	162	194	226		
3	35	67	99	131	163	195	227		
Movement averaging processing selection								0: Sampling processing 1: Movement averaging processing	
4	36	68	100	132	164	196	228		
Number of movement averaging processing								2 to 60	
5	37	69	101	133	165	197	229		
Pre-scale function selection								0: Pre-scale function invalid 1: × 1 2: × 0.1                                      3: × 0.01 4: × 0.001                                      5: × 0.0001	
6	38	70	102	134	166	198	230		
Pre-scale setting value								0 to 32767	
7	39	71	103	135	167	199	231		
Alarm output selection								0: Alarm output function invalid 1: Alarm output function valid	
17	49	81	113	145	177	209	241		
Alarm output setting value upper/upper limit								0 to 32767 and upper/upper limit $\geq$ upper/lower limit > lower/upper limit $\geq$ lower/lower limit	
19	51	83	115	147	179	211	243		
Alarm output setting value upper/lower limit									
20	52	84	116	148	180	212	244		
Alarm output setting value lower/upper limit									
21	53	85	117	149	181	213	245		
Alarm output setting value lower/lower limit									
22	54	86	118	150	182	214	246		
Count cycle change function selection								0: Count cycle change function selection invalid 1: Count cycle change function selection valid	
23	55	87	119	151	183	215	247		
Count cycle setting value								0: 1s 1: 100ms 2: 200ms 3: 500ms	
24	56	88	120	152	184	216	248		

Error code	Error name	Error	Operation status at error occurrence
810	Switch setting error	Any of the setting values of setting with the intelligent function module set on GX Developer is in error.	<ul style="list-style-type: none"> <li>• Count operation cannot be performed.</li> <li>• If an error occurs in any of the channels, all channels result in an error.</li> </ul>
820	Programmable controller CPU error	An error occurred in the programmable controller CPU.	The module continues operation.
830	Programmable controller CPU watch dog timer error	The watch dog timer error of the programmable controller CPU occurred.	Module READY (X0) turns off.
840	Module error	A module power off error occurred.	
850	Hardware error	Hardware fault.	

	Related buffer memory address								Setting range	Remedy
	CH1	CH2	CH3	CH4	CH5	CH6	CH7	CH8		
	Refer to "Section 4.5.2 Switch setting for intelligent function module".									Set the correct setting value on GX Developer, perform Write to PLC, and then switch power from off to on or reset the programmable controller CPU.
	-	-	-	-	-	-	-	-	-	Switch power from off to on or reset the programmable controller CPU.
	-	-	-	-	-	-	-	-	-	
	-	-	-	-	-	-	-	-	-	
	-	-	-	-	-	-	-	-	-	

APPENDICES

Appendix 1 External Dimension Diagram

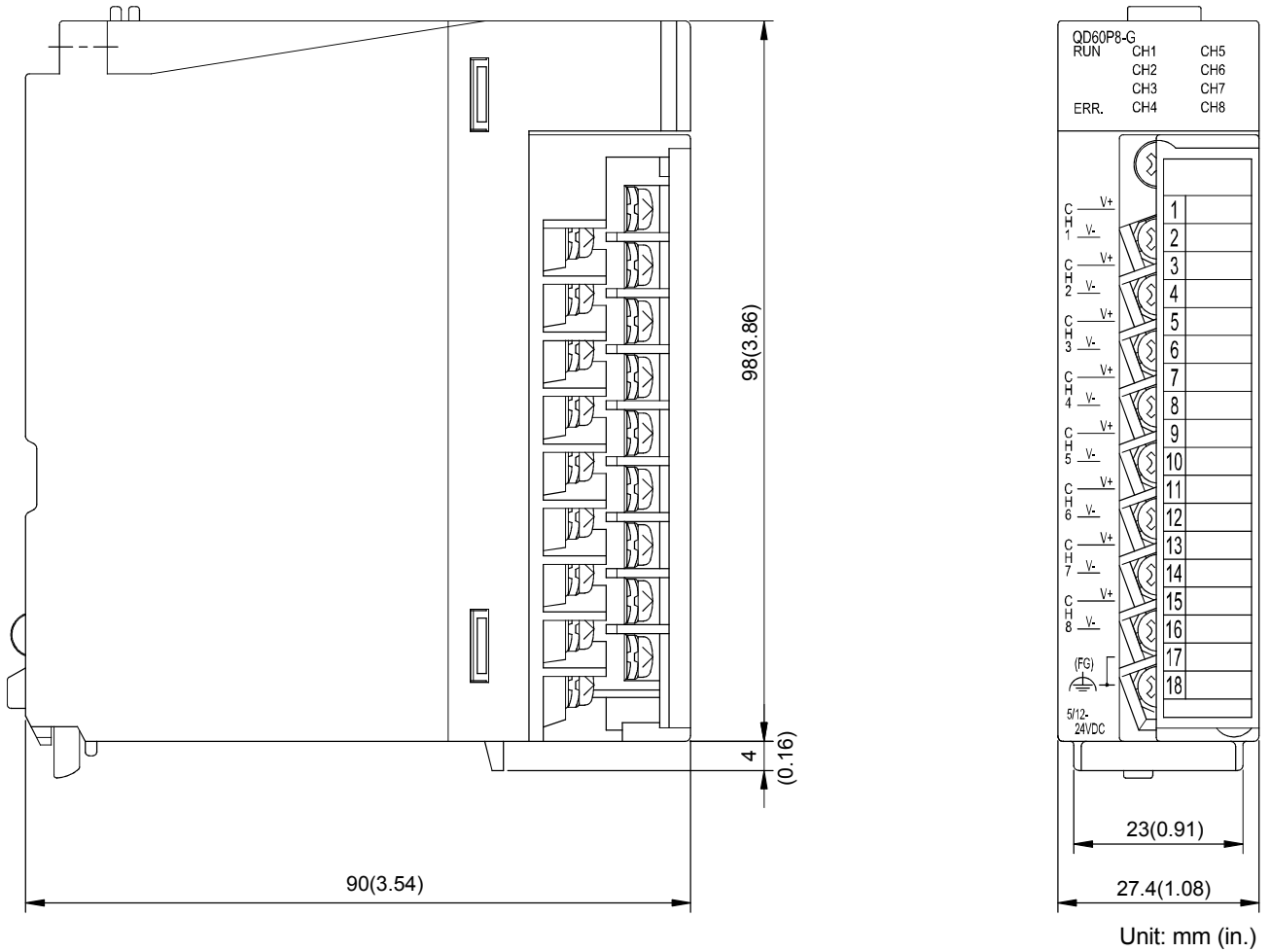



## INDEX

## [Numeral]

1-phase ..... 5- 1

## [A]

Accumulating count value ..... 1- 1, 3-11, 5- 3  
 Accumulating counter ..... 3- 3  
 Accumulating counter comparison flag  
 ..... 3- 6, 5-10  
 Alarm output  
 ~ Flag ..... 3-12, 5-16  
 ~ Function ..... 3- 3, 5-16  
 ~ Setting value ..... 3-13, 5-16  
 ~ Setting range outside error ..... 9- 8  
 ~ Selection ..... 3-12, 5-16  
 Applicable solderless terminals ..... 3- 1  
 Applicable wire size ..... 3- 1  
 Auto refresh ..... 6-14

## [B]

Buffer memory ..... 3- 8

## [C]

Carry over  
 ~ Detection flag ..... 3-12, 5- 7  
 ~ Reset request ..... 3-12, 5- 7  
 Comparison output  
 ~ Function ..... 3- 3, 5-10  
 ~ Selection ..... 3- 9, 5-10  
 ~ Setting value ..... 3- 9, 5-10  
 ~ Setting range outside error ..... 9- 8  
 Comparison signal reset request ..... 3- 7  
 Connected terminal ..... 3- 1  
 Count cycle  
 ~ Change function ..... 3- 3  
 ~ Change function selection ..... 3-13, 5- 4  
 ~ Setting range outside error ..... 9- 8  
 ~ Setting value ..... 3-13, 5- 4  
 Count enable ..... 3- 3, 3- 7  
 Count operation ..... 5- 2  
 Count response delay time ..... 5-18  
 Count type ..... 3- 1  
 Count value reading ..... 5- 3  
 Counter  
 Accumulating ~ ..... 3- 3  
 Linear ~ ..... 3- 3, 5- 5  
 Ring ~ ..... 3- 3, 5- 7

Counter reset

~ Function ..... 3- 3, 5-12

~ Request ..... 3-12, 5- 6, 5-12

Counting speed ..... 3- 1

## [D]

Dielectric withstand voltage ..... 1- 2, 3- 1

Duty ratio ..... 3- 1

## [E]

EMC Directive ..... A-12, 4- 5

Error

Code ..... 3-12, 9- 8

Confirming the ~ ..... 9- 3

List of ~ ..... 9- 8

~ Occurrence ..... 3- 5

~ Reset request ..... 3- 7

Type of ~ ..... 9- 5

External dimension diagram ..... App-1

## [F]

Features ..... 1- 1

Function ..... 3- 3, 6- 1

Function version ..... 2- 6

## [G]

Ground ..... 4- 5

GX Developer system monitor ..... 9- 3

## [H]

Hardware error ..... 9-10

## [I]

I/O signal ..... 3- 4

Initial setting ..... 6-12

Input filter setting ..... 4- 9

Input pulse number ..... 1- 1

Input pulse value ..... 3-11, 5- 3, 5- 9

Input signals ..... 3- 4, 3- 5

Input voltage selection ..... 4- 9

Installing, uninstalling ..... 6- 2

Insulation resistance ..... 3- 1

Intelligent function module switch ..... 4- 8

Intelligent function module switch setting error

..... 9- 5

Interface with external devices ..... 3-14

Internal circuit ..... 3-14



[L]  
 Linear counter..... 3- 3, 5- 5

[M]  
 Menu bar..... 6-11  
 Module error ..... 9-10  
 Module READY ..... 3- 5  
 Module's Detailed Information ..... 9- 4  
 Monitoring/Test..... 6-16  
 Mountable module..... 2-1  
 Movement averaging  
 ~ Function ..... 3- 3, 5-15  
 ~ Processing ..... 1- 1, 5-15  
 ~ Processing selection ..... 3-10, 5-15  
 ~ Setting range outside error..... 9- 8  
 Multiple CPU system..... 2- 3

[N]  
 Network module ..... 2- 2  
 Number of channel..... 3- 1  
 Number of movement averaging processing  
 ..... 3-10, 5-15

[O]  
 Online module change ..... 8- 1  
 ~ Conditions ..... 8- 2  
 ~ Function ..... 3- 3  
 ~ Operations ..... 8- 3  
 ~ Procedure ..... 8- 4  
 Operating condition setting complete flag ..... 3- 5  
 Operating condition setting request flag ..... 3- 7  
 Operating environment ..... 6- 4  
 Operation overview ..... 6- 8  
 Output signals..... 3- 4, 3- 7  
 Overflow..... 9- 5  
 ~ Detection flag..... 3-11, 5- 6  
 ~ Error ..... 5- 6, 9- 8

[P]  
 Performance specifications..... 3- 1  
 Program example..... 7- 4, 7- 9, 7- 13, 7-18  
 Programmable controller CPU error ..... 9-10  
 Precautions..... 6- 2  
 Pre-scale  
 ~ Function ..... 3- 3, 5-13  
 ~ Function selection..... 3-10, 5-13  
 ~ Setting range outside error..... 9- 8  
 ~ Setting value ..... 3-11  
 Pulse edge  
 ~ Selection ..... 4- 9

~ Selection function..... 3- 3  
 Pulse generator..... 1- 1, 4- 6, 4- 7

[R]  
 Read  
 Count value ~ ..... 5- 3  
 Ring counter..... 3- 3, 5- 7  
 Rise/Fall time ..... 3- 2

[S]  
 Sampling pulse number..... 1- 1, 3- 9, 5- 3  
 Screw  
 Module fixing ~ ..... 4- 1  
 Terminal block terminal ~..... 4- 1  
 Terminal block mounting ~..... 4- 1  
 Sequence program ..... 7- 1  
 Shielded twisted pair cable ..... 4- 4  
 Signal layout..... 3-14  
 Signal level..... 3- 1  
 Software version ..... 2- 4, 2- 6  
 Start ..... 6- 8  
 Starting utility..... 6-10  
 Switch setting error ..... 9-10

[T]  
 Terminal block..... 3- 1  
 Text file ..... 6- 7  
 Troubleshooting ..... 9- 1

[U]  
 Utility..... 3- 3, 6- 1

[V]  
 Version  
 Function ~ ..... 2- 6  
 Software ~ ..... 2- 4, 2- 6

[W]  
 Watch dog timer error ..... 9-10  
 Weight ..... 3- 1  
 Wiring ..... 4- 4

[X]  
 X device..... 3- 4

[Y]  
 Y device..... 3- 4



# WARRANTY

Please confirm the following product warranty details before using this product.

## 1. Gratis Warranty Term and Gratis Warranty Range

If any faults or defects (hereinafter "Failure") found to be the responsibility of Mitsubishi occurs during use of the product within the gratis warranty term, the product shall be repaired at no cost via the sales representative or Mitsubishi Service Company.

However, if repairs are required onsite at domestic or overseas location, expenses to send an engineer will be solely at the customer's discretion. Mitsubishi shall not be held responsible for any re-commissioning, maintenance, or testing on-site that involves replacement of the failed module.

### **[Gratis Warranty Term]**

The gratis warranty term of the product shall be for one year after the date of purchase or delivery to a designated place.

Note that after manufacture and shipment from Mitsubishi, the maximum distribution period shall be six (6) months, and the longest gratis warranty term after manufacturing shall be eighteen (18) months. The gratis warranty term of repair parts shall not exceed the gratis warranty term before repairs.

### **[Gratis Warranty Range]**

- (1) The range shall be limited to normal use within the usage state, usage methods and usage environment, etc., which follow the conditions and precautions, etc., given in the instruction manual, user's manual and caution labels on the product.
- (2) Even within the gratis warranty term, repairs shall be charged for in the following cases.
  1. Failure occurring from inappropriate storage or handling, carelessness or negligence by the user. Failure caused by the user's hardware or software design.
  2. Failure caused by unapproved modifications, etc., to the product by the user.
  3. When the Mitsubishi product is assembled into a user's device, Failure that could have been avoided if functions or structures, judged as necessary in the legal safety measures the user's device is subject to or as necessary by industry standards, had been provided.
  4. Failure that could have been avoided if consumable parts (battery, backlight, fuse, etc.) designated in the instruction manual had been correctly serviced or replaced.
  5. Failure caused by external irresistible forces such as fires or abnormal voltages, and Failure caused by force majeure such as earthquakes, lightning, wind and water damage.
  6. Failure caused by reasons unpredictable by scientific technology standards at time of shipment from Mitsubishi.
  7. Any other failure found not to be the responsibility of Mitsubishi or that admitted not to be so by the user.

## 2. Onerous repair term after discontinuation of production

- (1) Mitsubishi shall accept onerous product repairs for seven (7) years after production of the product is discontinued. Discontinuation of production shall be notified with Mitsubishi Technical Bulletins, etc.
- (2) Product supply (including repair parts) is not available after production is discontinued.

## 3. Overseas service

Overseas, repairs shall be accepted by Mitsubishi's local overseas FA Center. Note that the repair conditions at each FA Center may differ.

## 4. Exclusion of loss in opportunity and secondary loss from warranty liability

Regardless of the gratis warranty term, Mitsubishi shall not be liable for compensation of damages caused by any cause found not to be the responsibility of Mitsubishi, loss in opportunity, lost profits incurred to the user by Failures of Mitsubishi products, special damages and secondary damages whether foreseeable or not, compensation for accidents, and compensation for damages to products other than Mitsubishi products, replacement by the user, maintenance of on-site equipment, start-up test run and other tasks.

## 5. Changes in product specifications

The specifications given in the catalogs, manuals or technical documents are subject to change without prior notice.

Microsoft, Windows, Windows NT, and Windows Vista are registered trademarks of Microsoft Corporation in the United States and other countries.

Pentium is a trademark of Intel Corporation in the United States and other countries.

Ethernet is a trademark of Xerox Corporation.

All other company names and product names used in this manual are trademarks or registered trademarks of their respective companies.

SPREAD

Copyright (c) 1996 FarPoint Technologies, Inc.



SH(NA)-080313E-J(1012)MEE

MODEL: QD60P8-G-U-S-E

MODEL CODE: 13JR54

## **MITSUBISHI ELECTRIC CORPORATION**

HEAD OFFICE : TOKYO BUILDING, 2-7-3 MARUNOUCHI, CHIYODA-KU, TOKYO 100-8310, JAPAN  
NAGOYA WORKS : 1-14, YADA-MINAMI 5-CHOME, HIGASHI-KU, NAGOYA, JAPAN

When exported from Japan, this manual does not require application to the  
Ministry of Economy, Trade and Industry for service transaction permission.

Specifications subject to change without notice.