

Mitsubishi Programmable Controller

MELSEC **Q** series

Analog Input/Output Module User's Manual

- Q64AD2DA
- GX Configurator-AD (SW2D5C-QADU-E)
- GX Configurator-DA (SW2D5C-QDAU-E)

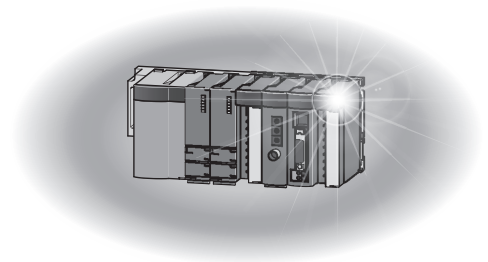

● SAFETY PRECAUTIONS ●

(Read these precautions before using this product.)

Before using this product, please read this manual and the relevant manuals carefully and pay full attention to safety to handle the product correctly.

The precautions given in this manual are concerned with this product only. For the safety precautions of the programmable controller system, refer to the user's manual for the CPU module used.

In this manual, the safety precautions are classified into two levels: "⚠ WARNING" and "⚠ CAUTION".



Indicates that incorrect handling may cause hazardous conditions, resulting in death or severe injury.



Indicates that incorrect handling may cause hazardous conditions, resulting in minor or moderate injury or property damage.

Under some circumstances, failure to observe the precautions given under "⚠ CAUTION" may lead to serious consequences.

Observe the precautions of both levels because they are important for personal and system safety. Make sure that the end users read this manual and then keep the manual in a safe place for future reference.

[Design Precautions]

⚠ WARNING

- Do not write any data to the "system area" and "write-protect area" of the buffer memory in the intelligent function module.
Also, do not use any "use prohibited" signals as an output signal from the programmable controller CPU to the intelligent function module.
Doing so may cause malfunction of the programmable controller system.

⚠ CAUTION

- Do not install the control lines or communication cables together with the main circuit lines or power cables.
Keep a distance of 100mm (3.94 inches) or more between them.
Failure to do so may result in malfunction due to noise.

[Installation Precautions]

CAUTION

- Use the programmable controller in an environment that meets the general specifications in the user's manual for the CPU module used.
Failure to do so may result in electric shock, fire, malfunction, or damage to or deterioration of the product.
- To mount the module, while pressing the module mounting lever located in the lower part of the module, fully insert the module fixing projection(s) into the hole(s) in the base unit and press the module until it snaps into place.
Incorrect mounting may cause malfunction, failure or drop of the module.
When using the programmable controller in an environment of frequent vibrations, fix the module with a screw.
- Tighten the screw within the specified torque range.
Undertightening can cause drop of the screw, short circuit or malfunction.
Overtightening can damage the screw and/or module, resulting in drop, short circuit, or malfunction.
- Shut off the external power supply for the system in all phases before mounting or removing the module.
Failure to do so may result in damage to the product.
A module can be replaced online (while power is on) on any MELSECNET/H remote I/O station or in the system where a CPU module supporting the online module change function is used.
Note that there are restrictions on the modules that can be replaced online, and each module has its predetermined replacement procedure.
For details, refer to the relevant chapter in this manual.
- Do not directly touch any conductive parts and electronic components of the module.
Doing so can cause malfunction or failure of the module.

[Wiring Precautions]

CAUTION

- Ground the FG terminal to the protective ground conductor dedicated to the programmable controller.
Failure to do so may result in electric shock or malfunction.

- After wiring, attach the included terminal cover to the module before turning it on for operation.
Failure to do so may result in electric shock.

- Use applicable solderless terminals and tighten them within the specified torque range.
If any spade solderless terminal is used, it may be disconnected when the terminal screw comes loose, resulting in failure.

- Tighten the terminal screw within the specified torque range.
Undertightening the terminal screws can cause short circuit or malfunction.
Overtightening can damage the screw and/or module, resulting in short circuit or malfunction.

- Prevent foreign matter such as dust or wire chips from entering the module.
Such foreign matter can cause a fire, failure, or malfunction.

[Wiring Precautions]

CAUTION

- A protective film is attached to the top of the module to prevent foreign matter, such as wire chips, from entering the module during wiring.
Do not remove the film during wiring.
Remove it for heat dissipation before system operation.

[Startup and Maintenance Precautions]

CAUTION

- Do not disassemble or modify the modules.
Doing so may cause failure, malfunction, injury, or a fire.
- Shut off the external power supply for the system in all phases before mounting or removing the module.
Failure to do so may cause the module to fail or malfunction.
A module can be replaced online (while power is on) on any MELSECNET/H remote I/O station or in the system where a CPU module supporting the online module change function is used.
Note that there are restrictions on the modules that can be replaced online, and each module has its predetermined replacement procedure.
For details, refer to the relevant chapter in this manual.
- After the first use of the product, do not mount/remove the module to/from the base unit, and the terminal block to/from the module more than 50 times (IEC 61131-2 compliant) respectively.
Exceeding the limit of 50 times may cause malfunction.
- Do not touch any terminal while power is on.
Doing so may cause malfunction.
- Shut off the external power supply for the system in all phases before cleaning the module or retightening the terminal screws or module fixing screws.
Failure to do so may cause the module to fail or malfunction.
Undertightening the screws can cause drop, short circuit, or malfunction.
Overtightening can damage the screw and/or module, resulting in drop, short circuit, or malfunction.
- Before handling the module, touch a grounded metal object to discharge the static electricity from the human body.
Failure to do so may cause the module to fail or malfunction.

[Disposal Precautions]

CAUTION

- When disposing of this product, treat it as industrial waste.

● CONDITIONS OF USE FOR THE PRODUCT ●

- (1) Mitsubishi programmable controller ("the PRODUCT") shall be used in conditions;
 - i) where any problem, fault or failure occurring in the PRODUCT, if any, shall not lead to any major or serious accident; and
 - ii) where the backup and fail-safe function are systematically or automatically provided outside of the PRODUCT for the case of any problem, fault or failure occurring in the PRODUCT.

- (2) The PRODUCT has been designed and manufactured for the purpose of being used in general industries.

MITSUBISHI SHALL HAVE NO RESPONSIBILITY OR LIABILITY (INCLUDING, BUT NOT LIMITED TO ANY AND ALL RESPONSIBILITY OR LIABILITY BASED ON CONTRACT, WARRANTY, TORT, PRODUCT LIABILITY) FOR ANY INJURY OR DEATH TO PERSONS OR LOSS OR DAMAGE TO PROPERTY CAUSED BY the PRODUCT THAT ARE OPERATED OR USED IN APPLICATION NOT INTENDED OR EXCLUDED BY INSTRUCTIONS, PRECAUTIONS, OR WARNING CONTAINED IN MITSUBISHI'S USER, INSTRUCTION AND/OR SAFETY MANUALS, TECHNICAL BULLETINS AND GUIDELINES FOR the PRODUCT.

("Prohibited Application")

Prohibited Applications include, but not limited to, the use of the PRODUCT in;

- Nuclear Power Plants and any other power plants operated by Power companies, and/or any other cases in which the public could be affected if any problem or fault occurs in the PRODUCT.
- Railway companies or Public service purposes, and/or any other cases in which establishment of a special quality assurance system is required by the Purchaser or End User.
- Aircraft or Aerospace, Medical applications, Train equipment, transport equipment such as Elevator and Escalator, Incineration and Fuel devices, Vehicles, Manned transportation, Equipment for Recreation and Amusement, and Safety devices, handling of Nuclear or Hazardous Materials or Chemicals, Mining and Drilling, and/or other applications where there is a significant risk of injury to the public or property.

Notwithstanding the above, restrictions Mitsubishi may in its sole discretion, authorize use of the PRODUCT in one or more of the Prohibited Applications, provided that the usage of the PRODUCT is limited only for the specific applications agreed to by Mitsubishi and provided further that no special quality assurance or fail-safe, redundant or other safety features which exceed the general specifications of the PRODUCTS are required. For details, please contact the Mitsubishi representative in your region.

REVISIONS

*The manual number is given on the bottom left of the back cover.

Print date	*Manual number	Revision
May, 2009	SH(NA)-080793ENG-A	First edition
Dec., 2010	SH(NA)-080793ENG-B	<p>Addition</p> <p>CONDITIONS OF USE FOR THE PRODUCT</p> <p>Correction</p> <p>SAFETY PRECAUTIONS, Relevant Manuals, GENERIC TERMS AND ABBREVIATIONS, Section 1.1, 2.1, 2.3, 3.1, 4.2.5, 4.2.7, 5.2.1, 6.17, 6.22, 7.4.1, 7.4.2, 7.4.3, 8.2.1, 8.3.1, 8.7, 10.1, Warranty</p>
May., 2015	SH(NA)-080793ENG-C	<p>Correction</p> <p>COMPLIANCE WITH THE EMC AND LOW VOLTAGE DIRECTIVES, GENERIC TERMS AND ABBREVIATIONS, Section 2.1, 3.1, 4.3.3, 7.3, 7.4.3, 8.2.1, 8.2.2, 9.2.1, 9.2.3</p>

Japanese Manual Version SH-080792-E

This manual confers no industrial property rights or any rights of any other kind, nor does it confer any patent licenses. Mitsubishi Electric Corporation cannot be held responsible for any problems involving industrial property rights which may occur as a result of using the contents noted in this manual.

INTRODUCTION

Thank you for purchasing the Mitsubishi MELSEC-Q series programmable controllers.

Before using the product, please read this manual carefully to develop full familiarity with the functions and performance of the Q series programmable controllers to ensure correct use.

CONTENTS

SAFETY PRECAUTIONS	A - 1
CONDITIONS OF USE FOR THE PRODUCT.....	A - 5
REVISIONS.....	A - 6
INTRODUCTION.....	A - 7
CONTENTS	A - 7
ABOUT MANUALS	A - 12
COMPLIANCE WITH THE EMC AND LOW VOLTAGE DIRECTIVES.....	A - 12
GENERIC TERMS AND ABBREVIATIONS.....	A - 13
PACKING LIST	A - 14

CHAPTER1 OVERVIEW **1 - 1 to 1 - 2**

1.1 Features.....	1 - 1
-------------------	-------

CHAPTER2 SYSTEM CONFIGURATION **2 - 1 to 2 - 7**

2.1 Applicable Systems	2 - 1
2.2 Using the Q64AD2DA with Redundant CPU	2 - 4
2.3 Checking Function Version, Serial Number, and Software Version	2 - 5

CHAPTER3 SPECIFICATIONS **3 - 1 to 3 - 11**

3.1 Performance Specifications	3 - 1
3.2 I/O Conversion Characteristic.....	3 - 4
3.2.1 I/O conversion characteristic of A/D conversion.....	3 - 4
3.2.2 I/O conversion characteristic of D/A conversion.....	3 - 9

CHAPTER4 FUNCTION **4 - 1 to 4 - 33**

4.1 Function List	4 - 1
4.2 Function Details of A/D Conversion.....	4 - 3
4.2.1 A/D conversion methods	4 - 3
4.2.2 Maximum and minimum values hold function.....	4 - 6
4.2.3 Scaling function (A/D conversion)	4 - 6
4.2.4 Shifting function (A/D conversion)	4 - 9
4.2.5 Input signal error detection function	4 - 11
4.2.6 Input range extended mode function	4 - 16
4.2.7 Logging function	4 - 18

4.3	Function Details of D/A Conversion	4 - 25
4.3.1	D/A output enable/disable function	4 - 25
4.3.2	Analog output HOLD/CLEAR function	4 - 25
4.3.3	Analog output test during a CPU module STOP.....	4 - 27
4.3.4	Scaling function (D/A conversion).....	4 - 28
4.3.5	Shifting function (D/A conversion)	4 - 31
4.4	Details of Common Function	4 - 33
4.4.1	Analog conversion enable/disable setting	4 - 33

CHAPTER5	I/O SIGNALS FOR THE CPU MODULE	5 - 1 to 5 - 10
-----------------	---------------------------------------	------------------------

5.1	List of I/O Signals.....	5 - 1
5.2	Details of I/O Signals	5 - 2
5.2.1	Input signals.....	5 - 2
5.2.2	Output signals.....	5 - 9

CHAPTER6	BUFFER MEMORY	6 - 1 to 6 - 38
-----------------	----------------------	------------------------

6.1	Buffer Memory Assignment	6 - 1
6.2	CH1 A/D Conversion Enable/Disable Setting (Un\G0)	6 - 10
6.3	CH1 Averaging Process Method Setting (Un\G1)	6 - 10
6.4	CH1 Averaging Process (Time/Number of Times) Setting (Un\G2).....	6 - 11
6.5	CH1 A/D Conversion Scaling Enable/Disable Setting (Un\G10)	6 - 11
6.6	CH1 A/D Conversion Scaling Lower Limit Value (Un\G11) and CH1 A/D Conversion Scaling Upper Limit Value (Un\G12)	6 - 12
6.7	CH1 Shifting Amount to Conversion Value (Un\G13).....	6 - 13
6.8	CH1 Input Signal Error Detection Setting (Un\G20)	6 - 13
6.9	CH1 Input Signal Error Detection Setting Value (Un\G21)	6 - 14
6.10	CH1 Logging Enable/Disable Setting (Un\G30).....	6 - 14
6.11	CH1 Logging Cycle Setting Value (Un\G31) and CH1 Logging Cycle Unit Setting (Un\G32)	6 - 15
6.12	CH1 Logging Data Setting (Un\G33)	6 - 16
6.13	CH1 Logging Points After Trigger (Un\G34)	6 - 16
6.14	CH1 Level Trigger Condition Setting (Un\G35)	6 - 17
6.15	CH1 Trigger Data (Un\G36).....	6 - 19
6.16	CH1 Trigger Setting Value (Un\G37)	6 - 19
6.17	CH1 Digital Output Value (Un\G100, Un\G1700)	6 - 20
6.18	CH1 Scaling Value (Un\G102, Un\G1710)	6 - 21
6.19	CH1 Maximum Digital Output Value (Un\G104, Un\G1720) and CH1 Minimum Digital Output Value (Un\G106, Un\G1721).....	6 - 22
6.20	CH1 Maximum Scaling Value (Un\G108, Un\G1740) and CH1 Minimum Scaling Value (Un\G110, Un\G1741).....	6 - 23
6.21	CH1 Setting Range (Un\G112)	6 - 24
6.22	CH1 A/D Conversion Completed Flag (Un\G113)	6 - 24

6.23	CH1 Input Signal Error Detection Flag (Un\G114).....	6 - 25
6.24	CH1 Oldest Pointer (Un\G120).....	6 - 26
6.25	CH1 Latest Pointer (Un\G121).....	6 - 27
6.26	CH1 Logging Data Points (Un\G122)	6 - 28
6.27	CH1 Trigger Pointer (Un\G123).....	6 - 28
6.28	CH1 Latest Error Code (Un\G190), CH1 Error Time (Un\G191 to Un\G194), Latest Error Code (Un\G1790), and Error Time (Un\G1791 to Un\G1794).....	6 - 29
6.29	CH5 D/A Conversion Enable/Disable Setting (Un\G800)	6 - 30
6.30	CH5 Digital Input Value (Un\G802).....	6 - 31
6.31	CH5 D/A Conversion Scaling Enable/Disable Setting (Un\G810)	6 - 32
6.32	CH5 D/A Conversion Scaling Lower Limit Value (Un\G811) and CH5 D/A Conversion Scaling Upper Limit Value (Un\G812)	6 - 33
6.33	CH5 Shifting Amount to Input Value (Un\G813)	6 - 33
6.34	CH5 Set Value Check Code (Un\G900, Un\G1764).....	6 - 34
6.35	CH5 Real Conversion Digital Value (Un\G902, Un\G1774).....	6 - 35
6.36	CH5 Setting Range (Un\G912).....	6 - 35
6.37	CH5 HOLD/CLEAR Function Setting (Un\G913).....	6 - 35
6.38	Level Data (Un\G1600 to Un\G1609)	6 - 36
6.39	Latest Address of Error History (Un\G1800).....	6 - 37
6.40	Error History (Un\G1810 to Un\G1964)	6 - 37
6.41	CH1 Logging Data Storage Area (Un\G5000 to Un\G14999).....	6 - 38

CHAPTER7 PREPARATORY PROCEDURES AND SETTING 7 - 1 to 7 - 20

7.1	Handling Precautions.....	7 - 1
7.2	Preparatory Procedures and Setting	7 - 2
7.3	Part Names.....	7 - 3
7.4	Wiring.....	7 - 5
7.4.1	Wiring precautions.....	7 - 5
7.4.2	External wiring	7 - 8
7.4.3	Wiring of external power supply connector.....	7 - 9
7.5	Setting from GX Developer.....	7 - 12
7.5.1	Intelligent function module detailed setting.....	7 - 12
7.5.2	Intelligent function module switch setting	7 - 14
7.6	Offset/Gain Correction	7 - 16

CHAPTER8 UTILITY PACKAGE (GX Configurator-AD/GX Configurator-DA) 8 - 1 to 8 - 26

8.1	Utility Package Functions	8 - 1
8.2	Installing and Uninstalling the Utility Package	8 - 2
8.2.1	Precautions for use.....	8 - 2
8.2.2	Operating environment.....	8 - 5

8.3	Operating the Utility Package	8 - 7
8.3.1	Common operations	8 - 7
8.3.2	Operation overview.....	8 - 9
8.3.3	Starting Intelligent function module utility	8 - 11
8.4	Initial Setting	8 - 14
8.5	Auto Refresh Setting.....	8 - 16
8.6	Monitor/Test.....	8 - 18
8.6.1	Monitor/Test window.....	8 - 18
8.7	FB Conversion of Initial Setting/Auto Refresh	8 - 21
8.8	Usage of FB.....	8 - 23
8.8.1	Overview.....	8 - 23
8.8.2	Pasting an FB to a sequence program	8 - 25
8.8.3	Converting (compiling) a sequence program.....	8 - 26

CHAPTER9	PROGRAMMING	9 - 1 to 9 - 34
-----------------	--------------------	------------------------

9.1	Programming Procedures.....	9 - 2
9.2	Programming for Normal System Configuration	9 - 4
9.2.1	Before program creation	9 - 6
9.2.2	Program example using the utility package.....	9 - 9
9.2.3	Program example without using the utility package.....	9 - 15
9.3	Programming for Remote I/O Network	9 - 19
9.3.1	Before program creation	9 - 21
9.3.2	Program example using the utility package.....	9 - 22
9.3.3	Program example without using the utility package.....	9 - 27

CHAPTER10	ONLINE MODULE CHANGE	10 - 1 to 10 - 15
------------------	-----------------------------	--------------------------

10.1	Execution Condition of Online Module Change	10 - 2
10.2	Operations During Online Module Change.....	10 - 3
10.3	Procedures of Online Module Change.....	10 - 4
10.3.1	When the initial setting has been configured with GX Configurator-AD or GX Configurator-DA	10 - 4
10.3.2	When the initial setting has been configured with sequence program.....	10 - 10

CHAPTER11	TROUBLESHOOTING	11 - 1 to 11 - 12
------------------	------------------------	--------------------------

11.1	Error Code List.....	11 - 1
11.2	Troubleshooting	11 - 5
11.2.1	When "RUN" LED turns off	11 - 5
11.2.2	When "ERR" LED turns on or blinks.....	11 - 5
11.2.3	When "ALM" LED blinks	11 - 5
11.2.4	When digital output values cannot be read.....	11 - 6
11.2.5	When A/D conversion completed flag does not turn on during use in normal mode	11 - 7
11.2.6	When an analog output value is not output	11 - 7
11.2.7	Checking the Q64AD2DA status	11 - 8

APPENDIX**App - 1 to App - 2**

Appendix 1 External Dimensions.....App - 1

INDEX**Index - 1 to Index - 2**

ABOUT MANUALS

The following manuals are also related to this product.
 Order each manual as needed, referring to the following list.

Relevant Manuals

Manual name	Manual number (model code)
GX Developer Version 8 Operating Manual Describes the methods for creating, printing, monitoring, and debugging programs with GX Developer. (Sold separately.)	SH-080373E (13JU41)
GX Developer Version 8 Operating Manual (Function Block) Describes the methods for creating and printing function blocks with GX Developer. (Sold separately.)	SH-080376E (13JU44)
GX Works2 Version1 Operating Manual (Common) System configuration, parameter settings, and online operations (common to Simple project and Structured project) of GX Works2 (Sold separately.)	SH-080779ENG (13JU63)

Remark

The manuals are included on the CD-ROM for the software package in PDF format.
 The printed manuals are sold separately. When obtaining a manual individually, order it by quoting the manual number (model code) in the table above.

COMPLIANCE WITH THE EMC AND LOW VOLTAGE DIRECTIVES

(1) For programmable controller system

To ensure that Mitsubishi programmable controllers maintain EMC and Low Voltage Directives when incorporated into other machinery or equipment, certain measures may be necessary. Please refer to one of the following manuals.

- QCPU User’s Manual (Hardware Design, Maintenance and Inspection)
- Safety Guidelines

(This manual is included with the CPU module or base unit.)

The CE mark on the side of the programmable controller indicates compliance with EMC and Low Voltage Directives.

(2) For the product

For the compliance of this product with the EMC and Low Voltage Directives, refer to Section 7.4.1 Wiring precautions.

GENERIC TERMS AND ABBREVIATIONS

Unless otherwise specified, this manual uses the following generic terms and abbreviations.

Generic term/ abbreviation	Description
Q64AD2DA	Abbreviation for the Q64AD2DA analog input/output module
GX Developer	Product name of the software package for the MELSEC programmable controllers
GX Works2	
GX Configurator-AD	Abbreviation for analog-digital converter module setting and monitor tool, GX Configurator-AD (SW2D5C-QADU-E)
GX Configurator-DA	Abbreviation for digital-analog converter module setting and monitor tool, GX-Configurator-DA (SW2D5C-QDAU-E)
QCPU (Q mode)	Generic term for the Basic model QCPU, High Performance model QCPU, Process CPU, Redundant CPU, and Universal model QCPU
Basic model QCPU	Generic term for the Q00JCPU, Q00CPU, and Q01CPU
High Performance model QCPU	Generic term for the Q02CPU, Q02HCPU, Q06HCPU, Q12HCPU, and Q25HCPU
Process CPU	Generic term for the Q02PHCPU, Q06PHCPU, Q12PHCPU, and Q25PHCPU
Redundant CPU	Generic term for the Q12PRHCPU and Q25PRHCPU
Universal model QCPU	Generic term for the Q00UJCPU, Q00UCPU, Q01UCPU, Q02UCPU, Q03UDCPU, Q03UDVCPU, Q03UDECPU, Q04UDHCPU, Q04UDVCPU, Q04UDEHCPU, Q06UDHCPU, Q06UDVCPU, Q06UDEHCPU, Q10UDHCPU, Q10UDEHCPU, Q13UDHCPU, Q13UDVCPU, Q13UDEHCPU, Q20UDHCPU, Q20UDEHCPU, Q26UDHCPU, Q26UDVCPU, Q26UDEHCPU, Q50UDEHCPU, and Q100UDEHCPU
Personal computer	IBM-PC/AT [®] -compatible personal computer
Factory default setting	Generic term for analog input ranges of 0 to 10V, 0 to 5V, 1 to 5V, -10 to 10V, 0 to 20mA, and 4 to 20mA, and for analog output ranges of 0 to 5V, 1 to 5V, -10 to 10V, 0 to 20mA, and 4 to 20mA
FB	Abbreviation for function block
Windows Vista [®]	Generic term for the following: Microsoft [®] Windows Vista [®] Home Basic Operating System, Microsoft [®] Windows Vista [®] Home Premium Operating System, Microsoft [®] Windows Vista [®] Business Operating System, Microsoft [®] Windows Vista [®] Ultimate Operating System, Microsoft [®] Windows Vista [®] Enterprise Operating System
Windows [®] XP	Generic term for the following: Microsoft [®] Windows [®] XP Professional Operating System, Microsoft [®] Windows [®] XP Home Edition Operating System

Generic term/ abbreviation	Description
Windows® 7	Generic term for the following: Microsoft® Windows® 7 Starter Operating System, Microsoft® Windows® 7 Home Premium Operating System, Microsoft® Windows® 7 Professional Operating System, Microsoft® Windows® 7 Ultimate Operating System, Microsoft® Windows® 7 Enterprise Operating System Note that the description "Windows® 7 (32-bit version)" indicates the 32-bit version only and "Windows® 7 (64-bit version)" indicates the 64-bit version only.

PACKING LIST

The following is included in the package.

Model	Product name	Quantity
Q64AD2DA	Q64AD2DA analog input/output module	1
	External power supply connector	1
SW2D5C-QADU-E	GX Configurator-AD Version 2 (Single license product) (CD-ROM)	1
SW2D5C-QADU-EA	GX Configurator-AD Version 2 (Volume license product) (CD-ROM)	1
SW2D5C-QDAU-E	GX Configurator-DA Version 2 (Single license product) (CD-ROM)	1
SW2D5C-QDAU-EA	GX Configurator-DA Version 2 (Volume license product) (CD-ROM)	1

CHAPTER1 OVERVIEW

This user's manual provides the specifications, handling instructions, programming procedures, and other information of the Q64AD2DA analog input/output module (hereinafter the "Q64AD2DA"), which is designed to use with the MELSEC-Q series CPU module.

1.1 Features

(1) Analog input and output using a module

The Q64AD2DA can perform both A/D conversion using four channels and D/A conversion using two channels.

(2) Ranges can be set for each channel

Various voltage or current range can be set for each channel.

Also, the ranges can be switched by using GX Developer.*¹

* 1 Set in Switch setting for I/O and intelligent function module dialog box.

(3) Switching resolution mode

A resolution can be selected from a normal resolution mode (1/4000) and high resolution mode (1/12000 or 1/16000).*²

* 2 Set in Switch setting for I/O and intelligent function module dialog box.

(4) Scaling function

Digital output values can be converted to scaling values (ratio (%)) and the converted values can be stored into buffer memory.

In D/A conversion, an input range of digital input values can be changed to a setting range and the analog output can be performed.

(5) Shifting function

In A/D conversion, a given value is added to an A/D converted digital output value.

In D/A conversion, a given value is added to a digital input value and an analog value is output.

Changing a shifting quantity reflects the output value in real time. Therefore, the output value can be adjusted with the shifting function when the CPU is powered on.

(6) Input range extended mode function

The analog input range, 4 to 20mA and 1 to 5V can be increased to the input range of 0 to 22mA and 0 to 5.5V, respectively.*³

A/D conversion can be performed even if the input range falls below 4mA or 1V, when sensors do not measure concrete values.

Combining the input range extended mode function and input signal error detection function detects a disconnection.

* 3 Set in Switch setting for I/O and intelligent function module dialog box.

(7) Logging facility

The A/D converted digital output values can be stored into buffer memory.
Logging data can be stored up to 10000th data point storage area for a channel.
The logging facility logs data every sampling periods in the shortest period.
In addition, the logging facility logs large volumes of data at high speeds, resulting in improving efficiency of debugging.

(8) Online module change

Modules can be changed without the system being stopped.

(9) Easy setting using GX Configurator-AD or GX Configurator-DA

The number of sequence programs can be reduced since GX Configurator-AD or GX Configurator-DA^{*1} (sold separately) allows the Q64AD2DA settings on the dialog box. Also, GX Configurator-AD or GX Configurator-DA simplifies checking of the module settings and operation status.

In addition, FB^{*2} can be automatically created from intelligent function module parameters set in advance to use them in a sequence program.

* 1 Either GX Configurator-AD or GX Configurator-DA checks the intelligent function module parameter setting and the setting status or operation status of the Q64AD2DA.

In addition, the setting and status can be checked by installing both GX Configurator-AD and GX Configurator-DA.

* 2 FB is the function for making a circuit block used in a sequence program repeatedly a part (FB) to use it in the sequence program.

This function can improve the efficiency of program development and minimize program bugs to improve program qualities.

For the details of FB, refer to GX Developer Version 8 Operating Manual (Function Block).

CHAPTER 2 SYSTEM CONFIGURATION

This chapter explains the system configuration of the Q64AD2DA.

2.1 Applicable Systems

This section describes the applicable systems.

(1) Applicable modules and base units, and number of modules

(a) When mounted with CPU module

For the applicable modules, the number of modules, and base units applicable to the Q64AD2DA, refer to the user's manual for the CPU module used.

Note the following when the Q64AD2DA is mounted with a CPU module.

- Depending on the combination with other modules or the number of mounted modules, power supply capacity may be insufficient. Pay attention to the power supply capacity before mounting modules, and if the power supply capacity is insufficient, change the combination of modules.
- Mount a module within the number of I/O points for the CPU module. If the number of slots is within the available range, the module can be mounted on any slot.

Remark

When the module is used with a C Controller module, refer to the user's manual for the C Controller module.

(b) When mounted with MELSECNET/H remote I/O station

For the MELSECNET/H remote I/O station, the number of modules, and base units applicable to the Q64AD2DA, refer to the Q Corresponding MELSECNET/H Network System Reference Manual (Remote I/O network).

(2) Support of multiple CPU system

When using the Q64AD2DA in a multiple CPU system, refer to the following manual first.

- QCPU User's Manual (Multiple CPU System)

(3) Support of online module change

The function version of the Q64AD2DA has been "C" from the first release, supporting online module change.

For details, refer to CHAPTER 10.

(4) Supported software packages

Operating the Q64AD2DA requires GX developer or GX Works2 with a software version that is compatible with the CPU system used.

The software packages, GX Configurator-AD and GX Configurator-DA^{*1}, are not required. The intelligent function module parameter setting, setting status, and operating status can be checked easily by using the packages.

The software versions compatible with GX Developer, GX Configurator-AD, GX Configurator-DA, and GX Works2 are listed in the Table 2.1.

Table 2.1 Compatible software package and software version

System		Software version			
		GX Developer ^{*2}	GX Configurator-AD	GX Configurator-DA	GX Works2
Q00J/Q00/ Q01CPU	Single CPU system	Version 7 or later	Version 2.10L or later	Version 2.10L or later	Refer to the GX Works2 Version 1 Operating Manual (Common).
	Multiple CPU system	Version 8 or later			
Q02/Q02H/Q06H/ Q12H/Q25HCPU	Single CPU system	Version 4 or later			
	Multiple CPU system	Version 6 or later			
Q02PH/ Q06PHCPU	Single CPU system	Version 8.68W or later			
	Multiple CPU system				
Q12PH/ Q25PHCPU	Single CPU system	Version 7.10L or later			
	Multiple CPU system				
Q12PRH/ Q25PRHCPU	Redundant CPU system	Version 8.45X or later			
Q00UJ/Q00U/ Q01UCPU	Single CPU system	Version 8.76E or later			
	Multiple CPU system				
Q02U/Q03UD/ Q04UDH/ Q06UDHCPU	Single CPU system	Version 8.48A or later			
	Multiple CPU system				
Q10UDH/ Q20UDHCPU	Single CPU system	Version 8.76E or later			
	Multiple CPU system				
Q13UDH/ Q26UDHCPU	Single CPU system	Version 8.62Q or later			
	Multiple CPU system				
Q03UDE/ Q04UDEH/ Q06UDEH/ Q13UDEH/ Q26UDEHCPU	Single CPU system	Version 8.68W or later			
	Multiple CPU system				
Q10UDEH/ Q20UDEHCPU	Single CPU system	Version 8.76E or later			
	Multiple CPU system				
CPU modules other than the above	Single CPU system	Cannot be used	Cannot be used	Cannot be used	
	Multiple CPU system				
When mounted to MELSECNET/H remote I/O station		Version 6 or later	Version 2.10L or later	Version 2.10L or later	

* 1 The setting of intelligent function module parameters for A/D conversion and D/A conversion, the setting status, and operating status can be checked by installing either GX Configurator-AD or GX Configurator-DA.

The setting and setting states can be checked with the installed GX Configurator-AD and GX Configurator-DA.

* 2 For the FB conversion function, use GX Developer 8 or later.

☒ POINT

- (1) Depending on the version of GX Configurator-AD or GX Configurator-DA, supported systems and CPU modules, and available functions of the Q64AD2DA vary.
- (2) When using GX Works2, refer to the following:
 - GX Works2 Version 1 Operating Manual (Common)
 - GX Works2 Version 1 Operating Manual (Intelligent Function Module)

1

OVERVIEW

2

SYSTEM CONFIGURATION

3

SPECIFICATIONS

4

FUNCTION

5

I/O SIGNALS FOR THE CPU MODULE

6

BUFFER MEMORY

7

PREPARATORY PROCEDURES AND SETTING

8

UTILITY PACKAGE (GX Configurator-AD/GX Configurator-DA)

2.2 Using the Q64AD2DA with Redundant CPU

(1) GX Configurator-AD and GX Configurator-DA

GX Configurator-AD and GX Configurator-DA cannot be used when accessing the Redundant CPU via an intelligent function module on an extension base unit from GX Developer.

Connect a personal computer to the Redundant CPU with a communication path indicated below.

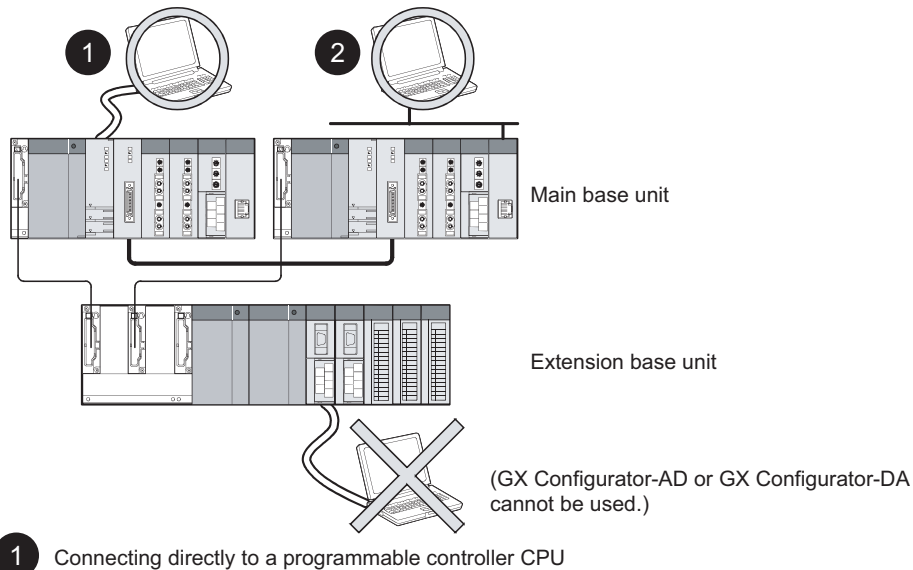

- 1 Connecting directly to a programmable controller CPU
- 2 Connecting to a programmable controller CPU via an intelligent function module (Ethernet module, MELSECNET/H module, or CC-Link module) on the main base unit

Figure 2.1 Communication path for GX Configurator-AD and GX Configurator-DA

2.3 Checking Function Version, Serial Number, and Software Version

This section describes how to check the function version of the Q64AD2DA and the software version of GX Configurator-AD or GX Configurator-DA.

(1) Checking the function version and serial number of the Q64AD2DA

The serial number and function version of the Q64AD2DA are described in the rating plate, on the front part of the module, or displayed in the System monitor dialog box of GX Developer.

(a) Checking on the rating plate on the side of the Q64AD2DA

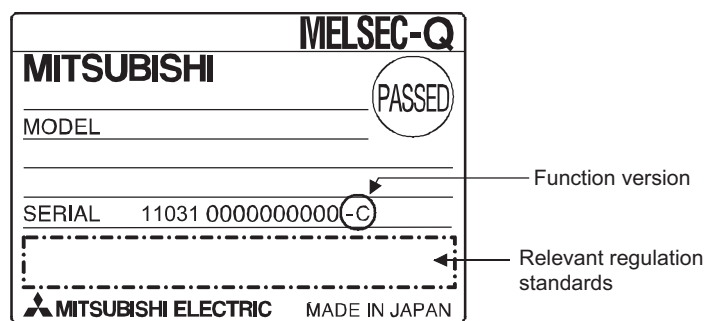

Figure 2.2 Rating plate on the side of module

(b) Checking on the front of the module

The serial number and function version on the rating plate is shown on the front (at the bottom) of the module.

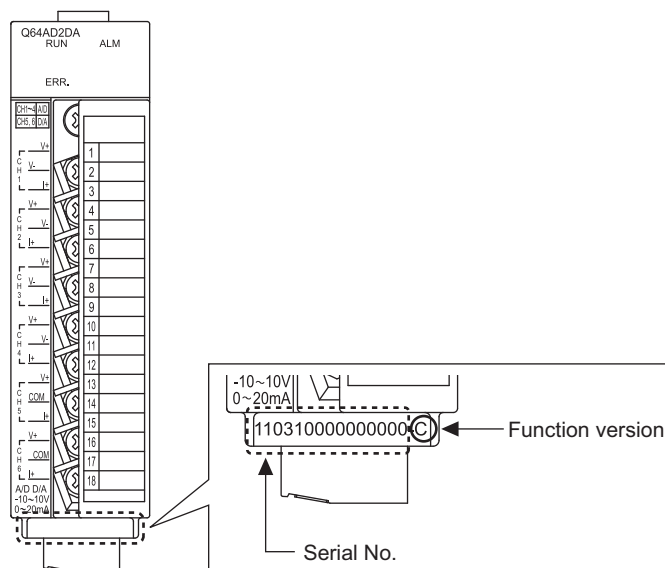

Figure 2.3 Description on the front part of module

- (c) Checking on the System monitor dialog box (Product Information List)
 To display the system monitor, select [Diagnostics] → [System monitor] and click the **Product Information List** button of GX Developer.

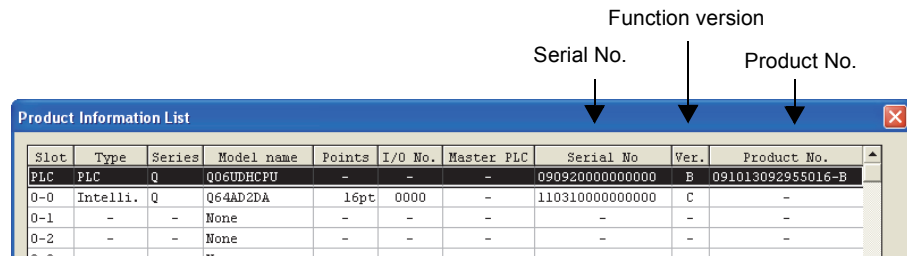

Figure 2.4 Checking the serial number and function version

POINT

The serial number displayed on the Product information list dialog box of GX Developer may differ from that on the rating plate and on the front of the module.

- The serial number on the rating plate and front part of the module indicates the management information of the product.
- The serial number displayed on the Product information list dialog box of GX Developer indicates the function information of the product.

The function information of the product is updated when a new function is added.

(2) Checking the software version of GX Configurator-AD and GX Configurator-DA

To check the software version of GX Configurator-AD and GX Configurator-DA, select [Help] → [Product information] of GX Developer.

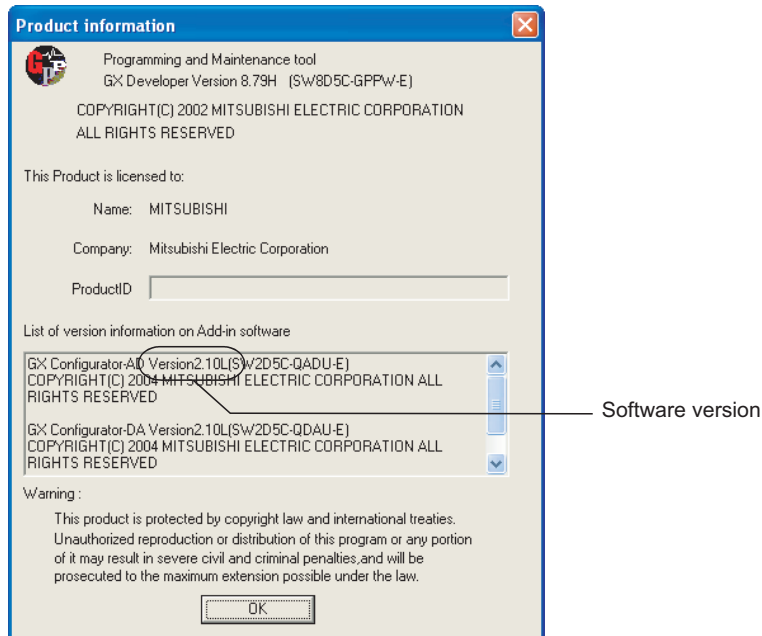

("Product information" dialog box of GX Developer Version 8)

Figure 2.5 Product information dialog box

CHAPTER3 SPECIFICATIONS

3.1 Performance Specifications

The following table shows the performance specifications of the Q64AD2DA.

Table 3.1 Performance specifications of the Q64AD2DA (1/2)

Item		Specifications					
A/D conversion area	Number of analog input points	4 points (4 channels)					
	Analog input	Voltage	-10 to 10VDC (Input resistance: 1M Ω)				
		Current	0 to 20mADC (Input resistance: 250 Ω)				
	Digital output	Normal resolution mode:-96 to 4095, -4096 to 4095, -1096 to 4595 High resolution mode:-384 to 16383, -288 to 12287, -16384 to 16383, -3288 to 13787					
	I/O characteristics and maximum resolution*1	Input	Analog input range	Normal resolution mode		High resolution mode	
				Digital output value	Maximum resolution	Digital output value	Maximum resolution
		Voltage	0 to 10V	0 to 4000	2.5mV	0 to 16000	0.625mV
			0 to 5V		1.25mV		0 to 12000
			1 to 5V		1.0mV	0.333mV	
			-10 to 10V	-4000 to 4000	2.5mV	-16000 to 16000	0.625mV
1 to 5V (Extended mode)			-1000 to 4500	1.0mV	-3000 to 13500	0.333mV	
Current		0 to 20mA	0 to 4000	5 μ A	0 to 12000	1.66 μ A	
		4 to 20mA		4 μ A		1.33 μ A	
		4 to 20mA (Extended mode)	-1000 to 4500	4 μ A	-3000 to 13500	1.33 μ A	
Accuracy (Accuracy relative to maximum digital output value)	Analog input range	Normal resolution mode		High resolution mode			
		Ambient temperature	0 to 55 $^{\circ}$ C	25 \pm 5 $^{\circ}$ C	0 to 55 $^{\circ}$ C	25 \pm 5 $^{\circ}$ C	
	Voltage	0 to 10V	\pm 0.4% (\pm 16digit)	\pm 0.1% (\pm 4digit)	\pm 0.4%	\pm 0.1%	
		-10 to 10V			(\pm 64digit)	(\pm 16digit)	
		0 to 5V			\pm 0.4% (\pm 48digit)	\pm 0.1% (\pm 12digit)	
		1 to 5V					
		1 to 5V (Extended mode)					
	Current	0 to 20mA	\pm 0.4% (\pm 48digit)	\pm 0.1% (\pm 12digit)			
		4 to 20mA					
		4 to 20mA (Extended mode)					
Conversion speed	500 μ s/channel						
Absolute maximum input	Voltage: \pm 15V Current: \pm 30mA*2						

Table 3.1 Performance specifications of the Q64AD2DA (2/2)

Item		Specifications					
D/A conversion area	Number of analog output points	2 points (2 channels)					
	Digital input	Normal resolution mode: -96 to 4095, -4096 to 4095 High resolution mode: -288 to 12287, -16384 to 16383					
	Analog output	Voltage	-10 to 10VDC (External load resistance: 1M Ω)				
		Current	0 to 20mADC (External load resistance: 600 Ω)				
	I/O characteristics and maximum resolution	Output Voltage	Analog output range	Normal resolution mode		High resolution mode	
				Digital input value	Maximum resolution	Digital input value	Maximum resolution
		0 to 5V	0 to 4000	1.25mV	0 to 12000	0.416mV	
		1 to 5V		1.0mV		0.333mV	
		-10 to 10V	-4000 to 4000	2.5mV	-16000 to 16000	0.625mV	
		Current	0 to 20mA	0 to 4000	5 μ A	0 to 12000	1.66 μ A
4 to 20mA	4 μ A		1.33 μ A				
Accuracy (Accuracy relative to maximum analog output value)	Output Voltage	Analog output range	Ambient temperature				
			0 to 55 $^{\circ}$ C		25 \pm 5 $^{\circ}$ C		
	0 to 5V	\pm 0.3% (\pm 30mV)	\pm 0.1% (\pm 10mV)				
	1 to 5V						
	-10 to 10V	\pm 0.3% (\pm 60 μ A)	\pm 0.1% (\pm 20 μ A)				
	0 to 20mA						
4 to 20mA							
Conversion speed	500 μ s/channel						
Absolute maximum output	Voltage: \pm 12V Current: 21mA						
Output short-circuit protection	Available						
Insulation specifications	Specific isolated area	Isolation method	Dielectric withstand voltage	Insulation resistance			
	Between input terminal and programmable controller power supply	Photocoupler isolation	500VACrms, 1min	500VDC 20M Ω or more			
	Between input/output channels	---	---	---			
Number of I/O occupied points	16 points (I/O assignment: Intelligent 16 points)						
External connection system	A/D conversion area, D/A conversion area: 18 points terminal block External power supply 24VDC, FG terminal connection: External power supply connector						
Applicable cable size	A/D conversion area, D/A conversion area: 0.3 to 0.75mm ² External power supply 24VDC, FG terminal connection: Refer to Table 3.2.* ³						
Applicable solderless terminals	A/D conversion area, D/A conversion area: R1.25-3 (Solderless terminals with sleeves are unavailable.) External power supply 24VDC, FG terminal connection: Not available						
External power supply	24VDC \pm 15%						
	Ripple, spike 500mV _{P-P} or less						
	Inrush current: 2.5A 150 μ s or less						
Internal current consumption (5VDC)	Current consumption: 0.19A						
Weight	0.17A						
	0.23kg						

* 1 For the details of the I/O conversion characteristic, refer to Section 3.2.1.

* 2 Indicates the value of the instant input current that does not break module inner electrical resistance. The maximum input current value is \pm 24mA when the current is impressed steadily.

* 3 The following shows the specifications of the cable applicable to an external power supply connector.

Table 3.2 Cable applicable to external power supply connector

Item	Specifications
Applicable cable size	0.2 to 3.3mm ² (AWG 24 to 12)
Size when inserting two cables into one terminal	Single wire: 0.2 to 0.8mm ² × 2
	Stranded wire: 0.2 to 0.8mm ² × 2
Screw tightening torque	0.5 to 0.6N·m

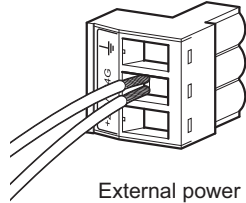

External power supply connector (accessory)

Figure 3.1 When inserting two cables into one terminal

Remark

For general specifications of the Q64AD2DA, refer to the user's manual for the CPU module used.

3.2 I/O Conversion Characteristic

3.2.1 I/O conversion characteristic of A/D conversion

The I/O conversion characteristic of A/D conversion represents the angle formed by a straight line connecting the "offset value" and "gain value" when the analog signals (voltage or current input) from outside the programmable controller are converted to digital values.

[Offset value]

The offset value refers to the analog input value (voltage or current) that makes the digital output value be 0.

[Gain value]

The gain value refers to the analog input value (voltage or current) that makes the digital output value be:

- 4000 (in normal resolution mode)
- 16000 or 12000 (in high resolution mode)

(1) Voltage input characteristic

Figure 3.2 shows voltage input characteristics.

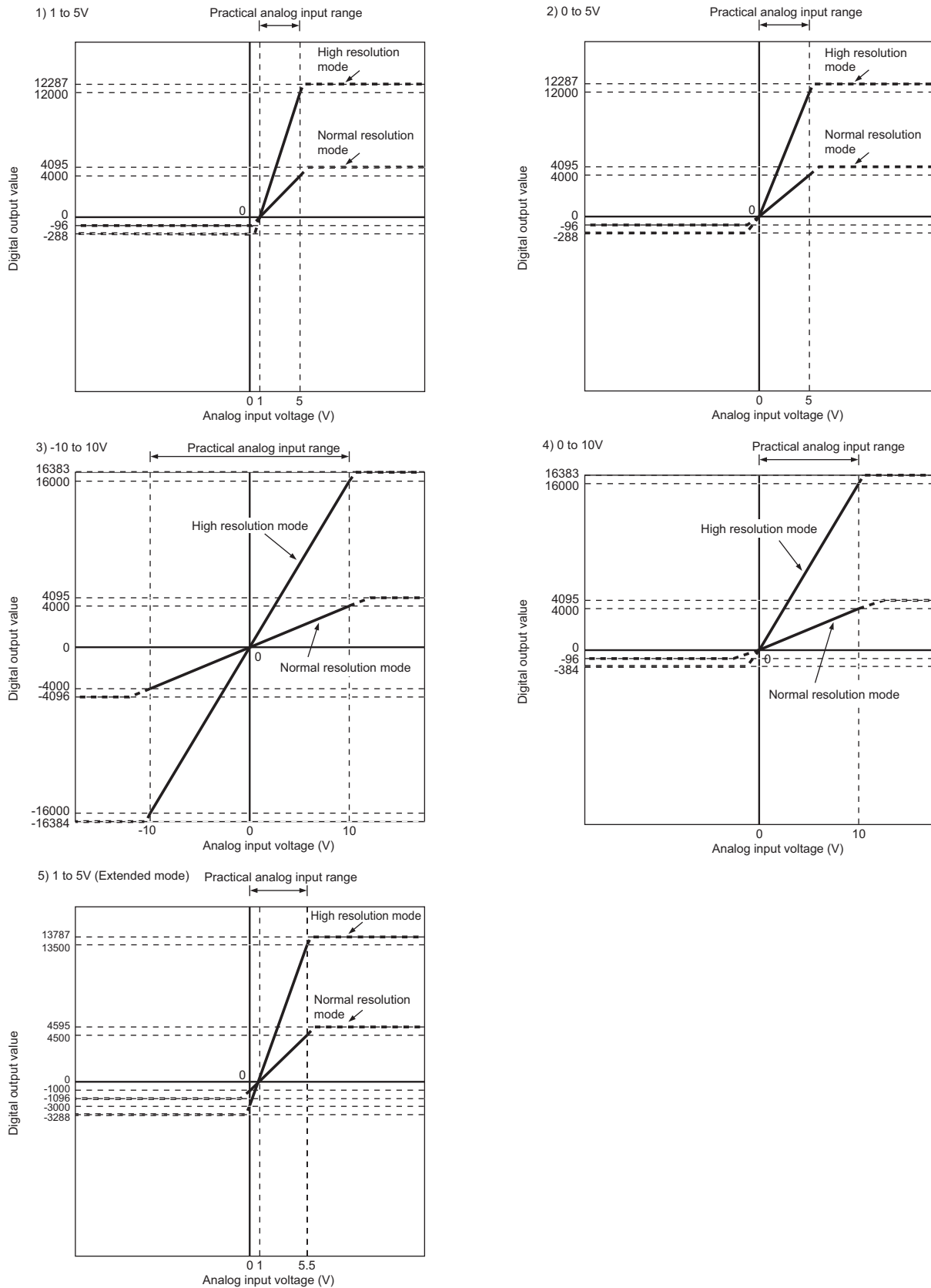

Figure 3.2 Voltage input characteristic

POINT

- (1) Set each input range within the practical analog input range and digital output range. If these ranges are exceeded, the maximum resolution and accuracy may not fall within the performance specifications. (Avoid using the dotted line area shown in Figure 3.2.)
- (2) Do not input an analog input voltage of ± 15 V or more. The input element may be damaged.
- (3) If an analog value that exceeds the range for the digital output value is entered, the digital output value will be fixed at the maximum or minimum value.

Table 3.3 Digital output values in the case of an analog value, exceeding the range for the digital output value, being entered

Analog input range setting	Digital output value (normal resolution mode)		Digital output value (high resolution mode)	
	Minimum	Maximum	Minimum	Maximum
1 to 5V	-96	4095	-288	12287
0 to 5V			-16384	16383
-10 to 10V	-4096		-384	
0 to 10V	-96			
1 to 5V (Extended mode)	-1096	4595	-3288	13787

(2) Current input characteristic

Figure 3.3 shows current input characteristics.

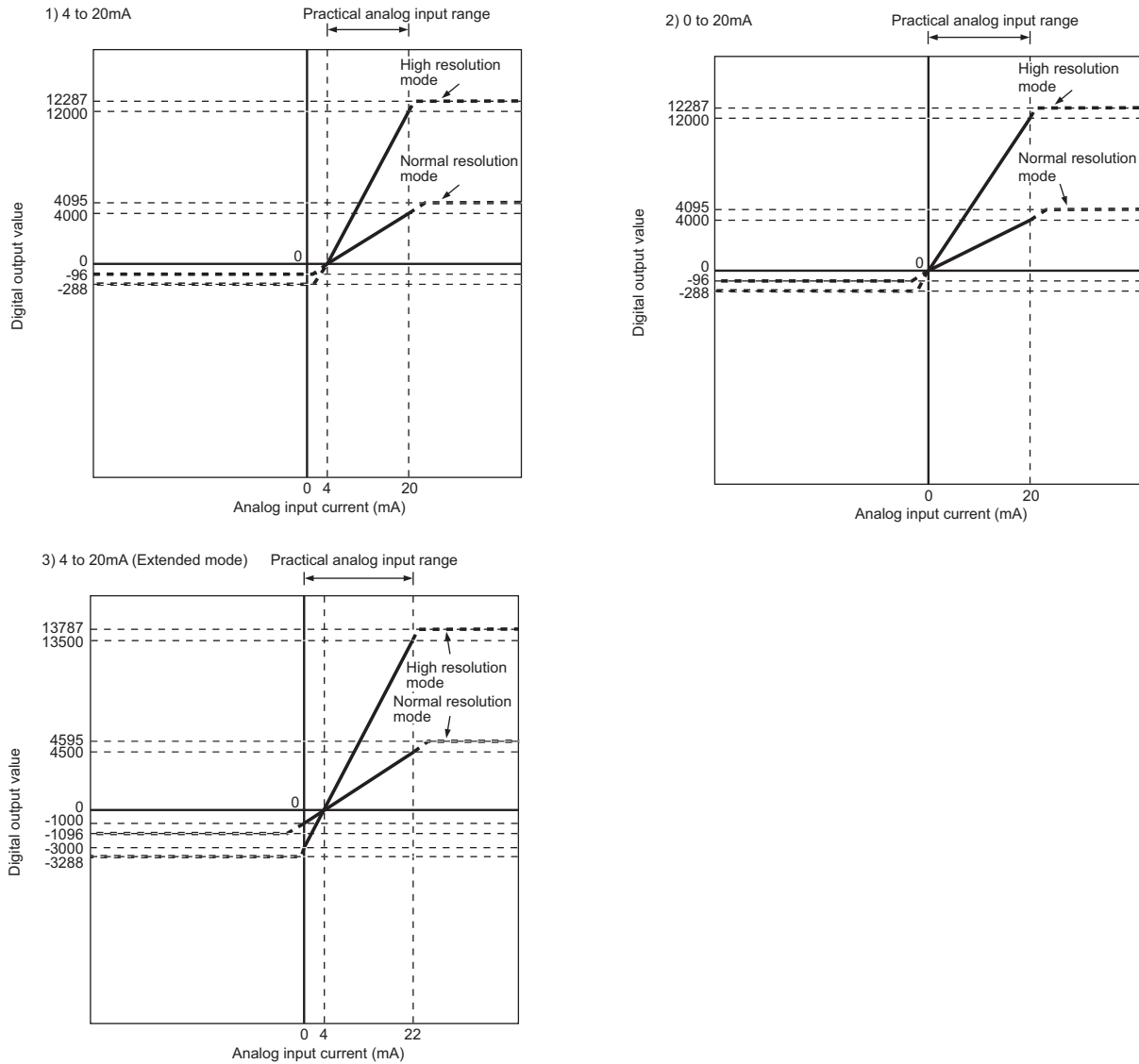

Figure 3.3 Current input characteristic

POINT

- (1) Set each input range within the practical analog input range and digital output range.
If these ranges are exceeded, the maximum resolution and accuracy may not fall within the performance specifications. (Avoid using the dotted line area shown in Figure 3.3.)
- (2) Do not input an analog input current of ± 30 mA or more. The input elements may be damaged.
- (3) If an analog value that exceeds the range of the digital output value is entered, the digital output value will be fixed at the maximum or minimum value.

Table 3.4 Digital output values in the case of an analog value, exceeding the range for the digital output value, being entered

Analog input range setting	Digital output value (normal resolution mode)		Digital output value (high resolution mode)	
	Minimum	Maximum	Minimum	Maximum
4 to 20mA	-96	4095	-288	12287
0 to 20mA				
4 to 20mA (Extended mode)	-1096	4595	-3288	13787

3.2.2 I/O conversion characteristic of D/A conversion

The I/O conversion characteristic of D/A conversion represents the angle formed by a straight line connecting the "offset value" and "gain value" when converting the digital input value written from the CPU module to an analog output value (voltage or current output).

[Offset value]

The offset value refers to the analog output value (voltage or current) when the digital input value set from the CPU module is 0.

[Gain value]

The gain value is the analog output value (voltage or current) when the digital input value set from the CPU module is:

- 4000 (in normal resolution mode)
- 12000 (when 1 to 5V, 0 to 5V, 4 to 20mA, or 0 to 20mA selected in high resolution mode)
- 16000 (when -10 to 10V is selected in high resolution mode)

(1) Voltage output characteristic

Figure 3.4 shows voltage output characteristics.

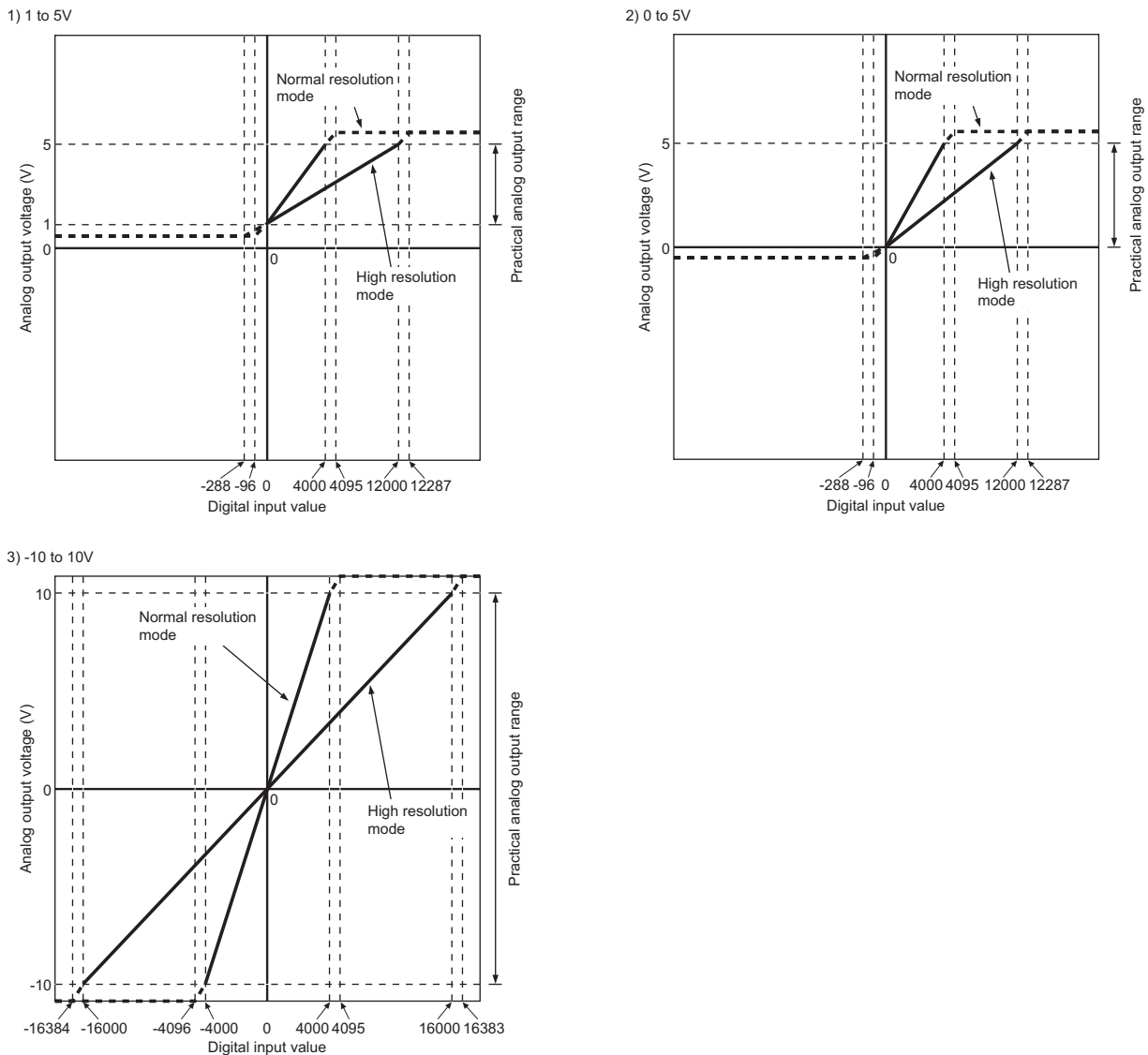

Figure 3.4 Voltage output characteristic

POINT

Set each output range within the practical digital input range and analog output range.

If these ranges are exceeded, the maximum resolution and accuracy may not fall within the performance specifications. (Avoid using the dotted line area shown in Figure 3.4.)

(2) Current output characteristic

Figure 3.5 shows current output characteristics.

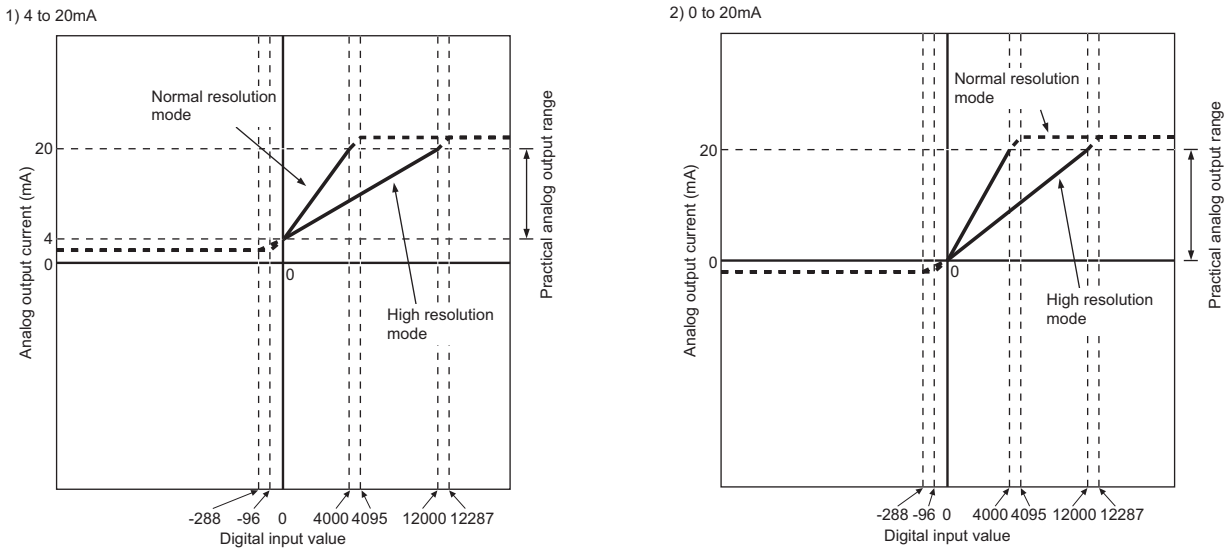

Figure 3.5 Current output characteristic

POINT

Set each output range within the practical digital input range and analog output range.

If these ranges are exceeded, the maximum resolution and accuracy may not fall within the performance specifications. (Avoid using the dotted line area shown in Figure 3.5.)

CHAPTER4 FUNCTION

The device numbers (X or Y) and buffer memory addresses described in this chapter are used for CH1. (The device numbers and buffer memory addresses specified in D/A conversion are used for CH5.)

For the device numbers and buffer memory addresses used for other channels, refer to Section 5.1 and Section 6.1.

4.1 Function List

Table 4.1 lists the functions of the Q64AD2DA.

Table 4.1 Function list

Item	Function	Reference section	
A/D conversion function	A/D conversion method	(1) Sampling processing The A/D conversion for analog input values is performed successively for each channel, and the digital output value is output upon each conversion. The value is stored in buffer memory. (2) Averaging processing The digital output value is averaged on a channel basis and the averaged value is stored in buffer memory. The averaging processing has three methods as follows: (a) Time average (b) Count average (c) Moving average	Section 4.2.1
	Maximum and minimum values hold function	(1) This function retains the maximum and minimum values of the digital output values and scaling values in the module. (2) The retained values can be reset in any timing.	Section 4.2.2
	Scaling function (A/D conversion)	This function converts digital output values to scaling values and stores the converted values into buffer memory. Time to configure a program for scaling can be decreased.	Section 4.2.3
	Shifting function (A/D conversion)	The digital output value can be adjusted easily with the shifting function when the CPU is powered on. The shifting function adds a setting quantity to a digital output value and stores the value into buffer memory.	Section 4.2.4
	Input signal error detection function	This function detects voltage or current input values exceeding the setting ranges. A channel set to averaging processing can be checked every sampling processing.	Section 4.2.5
	Input range extended mode function	This function increases input ranges. Combining the input range extended mode function and input signal error detection function detects a disconnection.	Section 4.2.6
	Logging facility	This function performs logging of the digital values that A/D conversion is performed. Logging data can be stored up to 10000th data point and time-series data that A/D conversion is performed can be referred and stored easily.	Section 4.2.7

Table 4.1 Function list

Item	Function	Reference section	
D/A conversion function	D/A output enable/disable function	(1) This function sets whether D/A conversion values are output or offset values are output for each channel. (2) The conversion speed does not change regardless of whether CH5 Output enable/disable flag (Y5) is enabled (ON) or disabled (OFF).	Section 4.3.1
	Analog output HOLD/CLEAR function	This function retains an output analog value for the case where the CPU module is placed in STOP or in a stop error status.	Section 4.3.2
	Analog output test during a CPU module STOP	When CH5 Output enable/disable flag (Y5) is set to on forcibly while the CPU module is placed in STOP status, the analog value that D/A conversion is performed is output.	Section 4.3.3
	Scaling function (D/A conversion)	This function changes an input range of digital input values to a given range between -32000 and 32000. Time to configure a program for scaling can be decreased.	Section 4.3.4
	Shifting function (D/A conversion)	The digital input value can be adjusted easily with the shifting function when the CPU is powered on. The shifting function adds a setting quantity to a digital input value and stores the value into buffer memory.	Section 4.3.5
Common function	Analog conversion enable/disable setting	(1) This function sets whether A/D or D/A conversion for each channel is enabled or disabled. (2) Setting the channels not to be used to be disabled decreases sampling periods. (3) The analog conversion enable/disable setting is set to be disabled for all channels conversion in default configuration.	Section 4.4.1
	Resolution mode	(1) A resolution can be selected from a normal resolution mode (1/4000) and high resolution mode (1/12000 or 1/16000). (2) Setting a resolution mode is performed for all the channels at once. (3) For details of a digital output value, digital input value, and a maximum resolution in normal resolution mode or high resolution mode, refer to Section 3.1.	Section 3.1 Section 7.5
	Online module change	Modules can be changed without the system being stopped.	CHAPTER 10

4.2 Function Details of A/D Conversion

4.2.1 A/D conversion methods

(1) Sampling period of the Q64AD2DA

A/D conversion is performed from CH1 to CH4 and D/A conversion is performed from CH5 to CH6 in series in 500 μ s per channel for the Q64AD2DA. Sampling period is the period of renewing digital output values. The period of renewing digital output values varies depending on the total number of channels enable A/D conversion and D/A conversion.

(2) Sampling processing

A/D conversion is made successively for analog input values, and the converted digital output values are stored in buffer memory.

(3) Averaging processing

Averaging processing requires at least two times of conversion processing excluding the maximum and the minimum values. After the first averaging processing is completed, A/D conversion completed flag (XE) is set to on.

(a) Time average

A/D conversion is made for the preset period of time, and the sum of values excluding maximum and minimum values is averaged, resulting in storing into the buffer memory.

The processing times within the set time varies depending on the number of channels used (total number of channels enable A/D conversion and D/A conversion).

The processing times within the set time is shown below.

$$\text{Processing times (Times)} = \frac{\text{Setting time}}{(\text{Numbers of channels to be used} \times 0.5)}$$

[Example] Processing times under the following setting

- Number of channels used . . . 4CH
A/D conversion: CH1, CH2, and CH3
D/A conversion: CH5
- Setting time . . . 15ms

$$\frac{15}{(4 \times 0.5)} = 7.5 \text{ (times)}$$

→ The figures after the decimal fractions are omit.
→ Seven times conversion processing are performed and the average value is output.
(7 × 4 × 0.5 = 14(ms) The average value is output every 14(ms).)

POINT

Set the setting time that meets the following condition for time averaging processing. If the setting time does not meet the following condition, an error (error code: □ 202) occurs and the digital output value changes to 0.

- Setting time \geq Minimum processing times 4 (times) \times 0.5(ms) \times Number of channels to be used (total number of A/D conversion and D/A conversion)

[Example] Number of channels to be used: Six channels

- Setting time \geq (4 \times 6 \times 0.5)
Set the setting time to 12ms or higher.

(b) Count average

A/D conversion is made the preset number of times, and the sum of values excluding the maximum and minimum values is averaged, resulting in storing into the buffer memory.

The time required for the count-based average value to be stored into the buffer memory varies depending on the number of channels used (number of channels enable A/D conversion and D/A conversion).

Processing time = Set count \times (Number of channels to be used \times 0.5) (ms)

[Example] Processing time under the following setting

- Number of channels used . . . 4CH
A/D conversion: CH1, CH2, and CH3
D/A conversion: CH5
- Set count . . . 20 times

$$20 \times 4 \times 0.5 = 40(\text{ms})$$

The averaged values are output every 40(ms).

POINT

Count average processing requires at least two times of conversion processing excluding the maximum and the minimum values. Set the setting time to four times or more.

(c) Moving average

The digital output values imported per sampling period are averaged to find a value, which is then stored into the buffer memory.

Since average processing is made with data shifted per sampling, the most recent digital output value is obtainable.

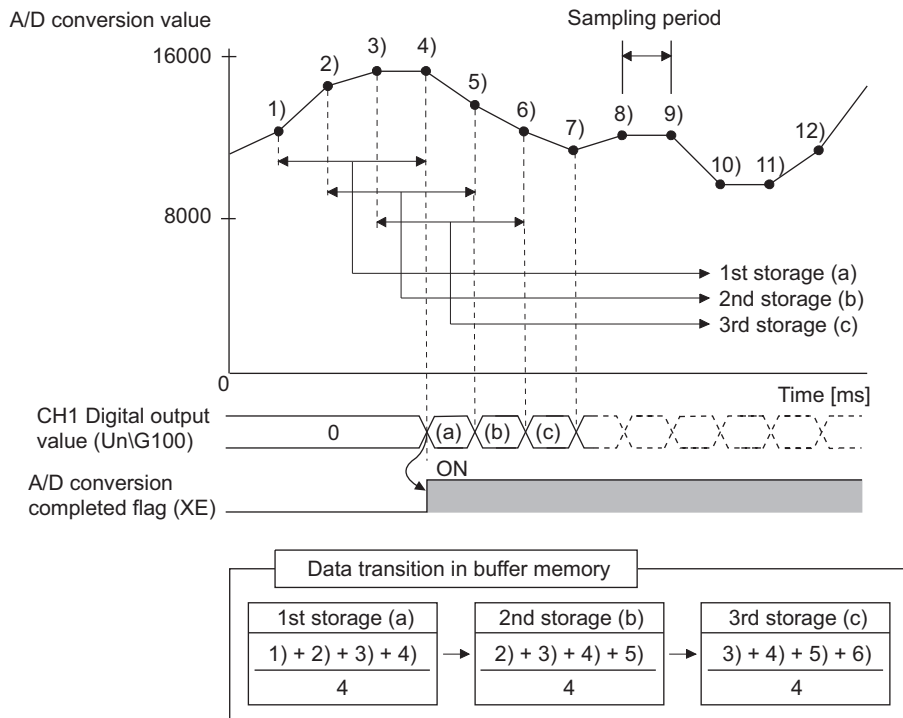

Figure 4.1 Moving average processing in the case of four setting times

4.2.2 Maximum and minimum values hold function

The maximum and minimum digital output value and scaling value are held in the buffer memory for each channel.

(1) Setting methods

- (a) The maximum and minimum values are stored into the following buffer memory when conversions start.
 - CH1 Maximum digital output value (Un\G104)
 - CH1 Minimum digital output value (Un\G106)
 - CH1 Maximum scaling value (Un\G108)
 - CH1 Minimum scaling value (Un\G110)
- (b) The maximum and minimum values are stored into the buffer memory after the following states.
 - Maximum and minimum values reset request (YD) is set to on.
 - Operating condition setting request (Y9) is set to off.

4.2.3 Scaling function (A/D conversion)

This function converts digital output values to scaling values (ratio (%)) and stores the converted values into buffer memory.

(1) Overview

- (a) Whether using the scaling function (A/D conversion) for each channel or not can be specified with CH1 A/D conversion scaling enable/disable setting (Un\G10).
- (b) The scaling function performs scaling conversion of the digital output values set with CH1 Digital output value (Un\G100) within the range set by the buffer memory.
 - CH1 A/D conversion scaling lower limit value (Un\G11)
 - CH1 A/D conversion scaling upper limit value (Un\G12)
- (c) The fractional portion of the output value converted with scaling function is rounded off and stored into CH1 Scaling value (Un\G102).
- (d) The setting range allowed for the A/D conversion scaling upper and lower limit values is -32000 to 32000.

POINT

The setting range allowed for the A/D conversion scaling upper and lower limit values is -32000 to 32000. Note that the resolution will not change even if an A/D conversion scaling upper/lower limit value is set to change more than the resolution.

(2) Setting methods

- 1) Set the buffer memory as follows:
 - Setting CH1 A/D conversion scaling enable/disable setting (Un\G10) to be enabled (0).
 - Setting a value corresponding to the upper limit^{*1} of digital output as the scaling upper limit value set with CH1 A/D conversion scaling upper limit value (Un\G12).
 - Setting a value corresponding to the lower limit^{*2} of digital output as the scaling lower limit value set with CH1 A/D conversion scaling lower limit value (Un\G11).

* 1 Input range from -10 to 10V, normal resolution: 4000

* 2 Input range from -10 to 10V, normal resolution: -4000

- 2) Set Operating condition setting request (Y9) to on.

(3) How to calculate a scaling value

1) Input range: 0 to 10V, 0 to 5V, 1 to 5V, 0 to 20mA, and 4 to 20mA

$$\text{Scaling value} = \frac{Dx \times (SH - SL)}{D_{\text{Max}}} + SL$$

2) Input range: -10 to 10V

$$\text{Scaling value} = \frac{Dx \times (SH - SL)}{D_{\text{Max}} - D_{\text{Min}}} + \frac{SH + SL}{2}$$

Dx : CH1 Digital output value (Un/G100)

DMax : The maximum digital output value in the input range being used

DMin : The minimum digital output value in the input range being used

SH : CH1 A/D conversion scaling upper limit value (Un/G12)

SL : CH1 A/D conversion scaling lower limit value (Un/G11)

[Setting example]

Using the scaling function (A/D conversion) in input range from -10 to 10V and high resolution mode (from -16000 to 16000)

(a) Setting value

- CH1 A/D conversion scaling upper limit value (Un/G12) SH: 14000
- CH1 A/D conversion scaling lower limit value (Un/G11) SL: 2000

(b) Input value

Digital output value Dx: 7500

$$\text{Scaling value} = \frac{7500 \times (14000 - 2000)}{16000 - (-16000)} + \frac{(14000 + 2000)}{2}$$

$$= 10812.5$$

$$= 10813$$

Fractional portion is rounded off.

4.2.4 Shifting function (A/D conversion)

The shifting function adds a setting quantity to a digital output value (shifting a digital output value) and stores the value into buffer memory.

(1) Overview

- (a) The shifted output values are stored into CH1 Scaling value (Un\G102).
- (b) The shifting amount to conversion value can be set within the range from -32768 to 32767.
- (c) Changing the shifting amount to conversion value reflects the scaling value in real time. Therefore, the digital output value can be adjusted with the shifting function when the CPU is powered on.
- (d) If a scaling function (for A/D conversion) is used simultaneously, the value that is made scaling processing will be shifted.

(2) Setting methods

- (a) Set the quantity to be shifted by using CH1 Shifting amount to conversion value (Un\G13).
- (b) Shifting quantities are added to the digital output value set with CH1 Digital output value (Un\G100) every sampling period, and then the added value is stored into CH1 Scaling value (Un\G102).
- (c) The default of shifting amount to conversion value is 0.
- (d) If a value is written to a shifting amount to conversion value, regardless of whether Operating condition setting request (Y9) is set to on or off, the shifting amount to conversion value will be added every sampling period.

(3) Setting example

For the channel in setting the input range to 0 to 5V and the high resolution mode (to 0 to 12000), I/O characteristic is adjusted as shown below.

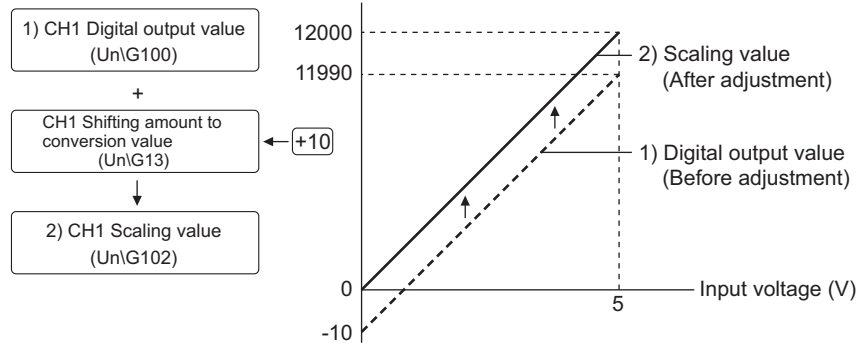

Input voltage (V)	CH1 Digital output value (UnG100)	Input voltage (V)	CH1 Scaling value (UnG102)
0	-10	0	0
5	11990	5	12000

Figure 4.2 I/O characteristic and scaling value after shifting processing

For the case of above example, set CH1 Shifting amount to conversion value (UnG13) to 10.

POINT

If the scaling value exceeds the range from -32768 to 32767 after a shifting processing, the value of lower (-32768) and upper (32767) limits will be fixed.

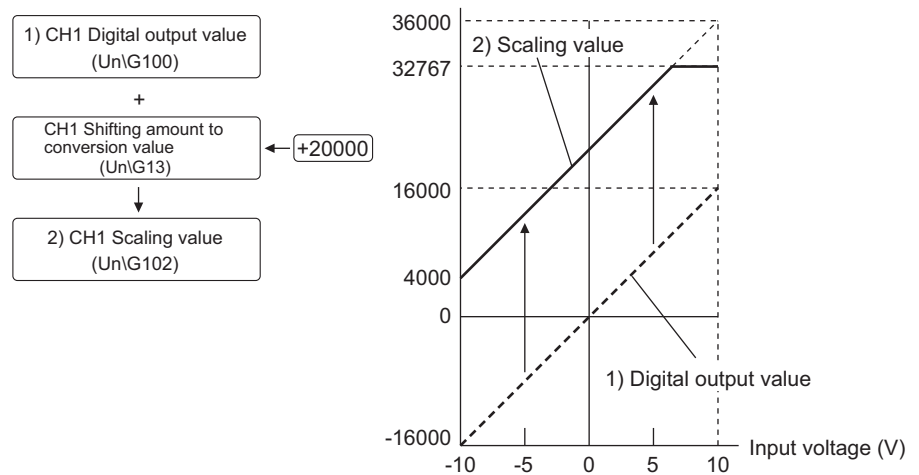

Figure 4.3 Scaling value for the case of exceeding the range from -32768 to 32767, resulted from shifting processing

4.2.5 Input signal error detection function

Input signal error detection function is the function that detects voltage or current input exceeding a setting range.

(1) Overview

- (a) If the input voltage or current rises to or above the input signal error detection upper limit value or falls to or below the lower limit value, an error occurs under the following operations.
 - CH1 Input signal error detection flag (Un\G114) is set to on (1).
 - Input signal error detection signal (X7) is set to on.
 - ALM LED blinks.
- (b) When CH1 Input signal error detection flag (Un\G114) is set to on (1), a digital output value immediately before the error detection is held for the channel. In addition, CH1 A/D conversion completed flag (Un\G113) is set to off (0).
- (c) To set CH1 Input signal error detection flag (Un\G114) and Input signal error detection signal (X7) to off, set Error clear request (YF) to on after the analog input value returns to within the setting range. ALM LED turns off immediately after CH1 Input signal error detection flag (Un\G114) is set to off (0).
- (d) When the analog input value returns to within the setting range, A/D conversion is resumed independently of whether CH1 Input signal error detection flag (Un\G114) and Input signal error detection signal (X7) are reset or not, CH1 A/D conversion completed flag (Un\G113) of the corresponding channel is set to on again after the first updating. (ALM LED remains blinking.)

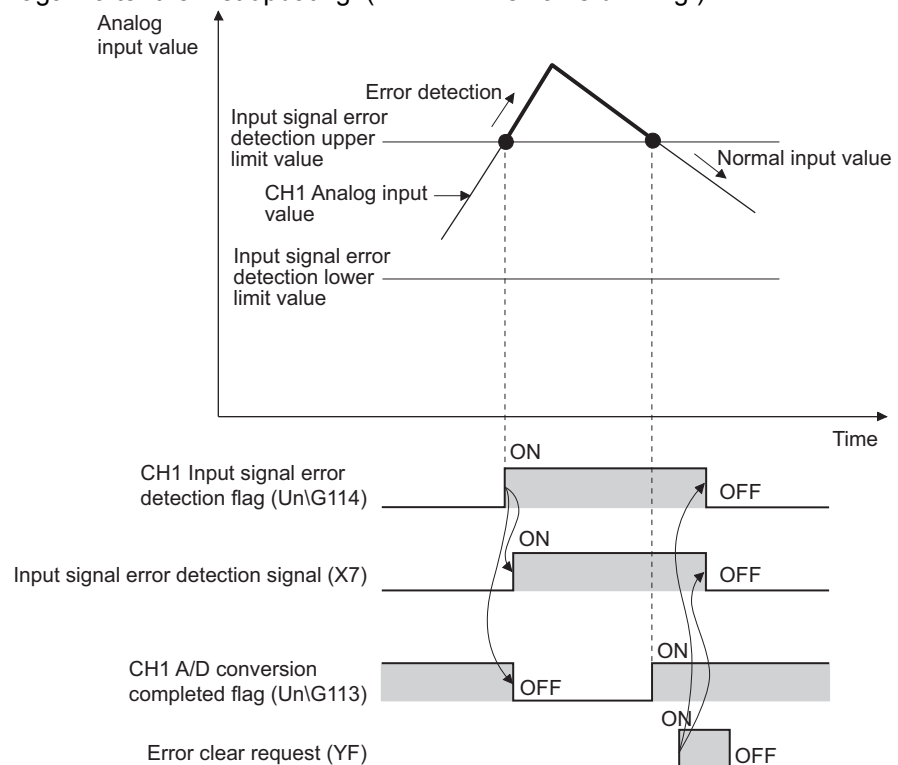

Figure 4.4 Input signal error detection

- (e) The input signal error detection is executed at every sampling processing.
- (f) The condition of the input signal error detection can be set with CH1 Input signal error detection setting (Un\G20).

The conditions of the input signal error detection are described in the table below.

Table 4.2 Condition of input signal error detection and operation

CH1 Input signal error detection setting (Un\G20)	Condition of input signal error detection	
Upper and lower detection (1)	If the analog input value reaches to or exceeds the input signal error detection upper limit setting value or falls to or below the input signal error detection lower limit setting value, an error is detected.	
Lower detection (2)	If the analog input value falls to or below the input signal error detection lower limit setting value, an error is detected. Even if the analog input value reaches to or exceeds the input signal error detection upper limit setting value, an error is not detected.	
Upper detection (3)	If the analog input value exceeds the input signal error detection upper limit setting value, an error is detected. Even if the analog input value falls to or below the input signal error detection lower limit setting value, an error is not detected.	
Disconnection detection (4)	Disconnection detection is executed.	Refer to Section 4.2.6 (3).

POINT

Setting CH1 Input signal error detection setting (Un\G20) for the channel setting the following input ranges detects disconnection. (Refer to Section 4.2.6 (3).)

- 4 to 20mA (Extended mode)
- 1 to 5V (Extended mode)

If CH1 Input signal error detection setting (Un\G20) is set to detect disconnection (4) for the channel setting input ranges other than above ranges, an error (error code: □212) occurs.

(2) Setting methods

- 1) Set the value for CH1 Input signal error detection setting value (Un\G21) of corresponding channels in 0.1% increments.
- 2) Set the value for CH1 A/D conversion enable/disable setting (Un\G0) of corresponding channels to A/D conversion enable (0).
- 3) Select the condition of input signal error detection to be used from 1 to 3 in the Table 4.2 for CH1 Input signal error detection setting (Un\G20) of corresponding channels.
- 4) Validate the setting of Operating condition setting request (Y9) from off to on.

(3) Specifying the upper and lower limit value for the input signal error detection

The setting for upper and lower limit value of input signal error detection is based on CH1 Input signal error detection setting value (Input signal error detection upper limit value and Input signal error detection lower limit value). (The value is set in increments of 1(0.1%))

When the upper and lower detection is set, CH1 Input signal error detection setting value (Un\G21) is reflected to both upper and lower limit value of input signal error detection.

(a) Input signal error detection upper limit value

A value that the addition of "a value multiplied an input range width (gain value - offset value) by CH1 Input signal error detection setting value" to a gain value. The setting is available only when the value is a gain value or more.

$$\text{Input signal error detection setting value} = \frac{\text{Input signal error detection upper limit value} - \text{Gain value of each range}}{\text{Gain value of each range} - \text{Offset value of each range}} \times 1000$$

(b) Input signal error detection lower limit value

A value that the subtraction of "a value multiplied an input range width (gain value - offset value) by CH1 Input signal error detection setting value" from a lower limit value of input range.

The setting is available only when the value is a lower limit value of input range or less.

$$\text{Input signal error detection setting value} = \frac{\text{Lower limit value of each range} - \text{Input signal error detection upper limit value}}{\text{Gain value of each range} - \text{Offset value of each range}} \times 1000$$

The following table shows lower limit values, offset values, and gain values calculated in setting input ranges.

Table 4.3 Lower limit values, offset values, and gain values calculated by setting input ranges

Input	Analog input range	Lower limit value	Offset value	Gain value
Voltage	0 to 10V	0V	0V	10V
	0 to 5V	0V	0V	5V
	1 to 5V	1V	1V	5V
	-10 to 10V	-10V	0V	10V
	1 to 5V (Extended mode)	1V	1V	5V
Current	0 to 20mA	0mA	0mA	20mA
	4 to 20mA	4mA	4mA	20mA
	4 to 20mA (Extended mode)	4mA	4mA	20mA

(4) Setting examples of the Input signal error detection

[Setting example]

To detect an input signal error when the analog input value is 2.4mA or less, which is for the analog input range of the channel is set to 4 to 20mA.

(a) Set CH1 Input signal error detection setting value (Un\G21)

The setting values will be turned out when the following values are assigned to the calculating formula of the input signal error detection lower value described in (3) of this section.

- Input signal error detection lower limit value: 2.4mA
- Lower limit value of input range (offset value): 4.0mA
- Gain value: 20.0mA

$$\begin{aligned} \text{Input signal error} &= \frac{4.0 - 2.4}{20.0 - 4.0} \times 1000 \\ \text{detection setting value} &= 100(10.0\%) \end{aligned}$$

Therefore, use "100 (10.0%)" for the setting of CH1 Input signal error detection setting value (Un\G21).

(b) Set CH1 Input signal error detection setting (Un\G20) in the lower detection (2)

In this case, the value for CH1 Input signal error detection operates as below.

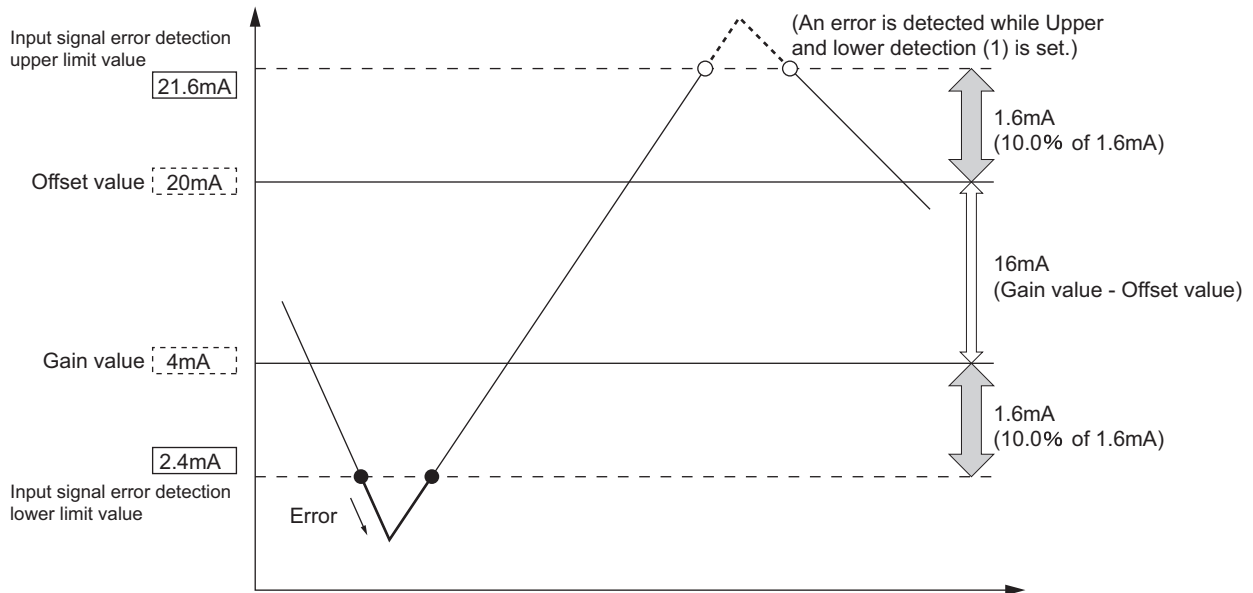

Figure 4.5 Setting example1 of Input signal error detection function

When CH1 Input signal error detection setting (Un\G20) is set in the upper and lower detection (1), an error will be detected in 21.6mA not only 2.4mA by the setting of "100 (10.0%)"

4.2.6 Input range extended mode function

The input range extended mode function is the function increasing the input range of 4 to 20mA and 1 to 5V.

Table 4.4 Input range and digital output value for extended mode

Normal mode			Extended mode		
Input range	Input range	CH1 Digital output value (Un\G100)	Input range	Increased range	CH1 Digital output value (Un\G100)
4 to 20mA	4 to 20mA	-96 to 4095 (-288 to 12287)* ¹	4 to 20mA (Extended mode)	0.0 to 22.0mA	-1096 to 4595 (-3288 to 13787)* ¹
1 to 5V	1 to 5V		1 to 5V (Extended mode)	0.0 to 5.5V	

*¹ The values in parenthesis refer to the range of digital outputs for setting high resolution mode.

(1) Overview

- (a) The input range extended mode function can monitor the values that fall below 4mA or 1V, so that sensors do not measure concrete values.
- (b) The slopes of the lines representing I/O characteristic are same between the extended mode and the normal mode. However, the input range expands and the upper and lower limit values of CH1 Digital output value (Un\G100) extend in the extended mode.

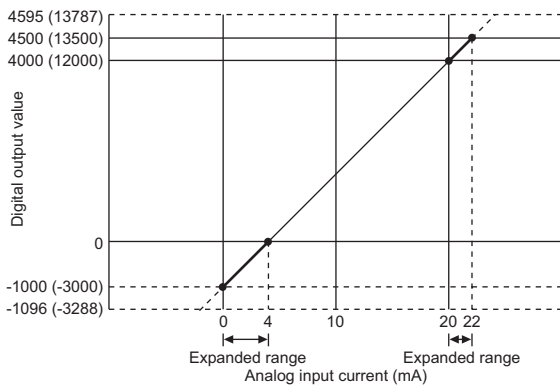

The value in parenthesis refers to the digital output value in high resolution mode.

Figure 4.6 I/O characteristic of input range from 4 to 20mA (Extended mode)

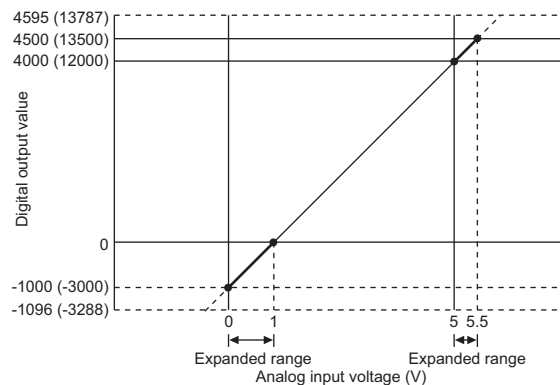

The value in parenthesis refers to the digital output value in high resolution mode.

Figure 4.7 I/O characteristic of input range from 1 to 5V (Extended mode)

(2) Setting methods

Configure the input range (for CH1 to CH4) in "Switch 1" cell of the Switch setting for I/O and intelligent function module dialog box. (Refer to Section 7.5.2.)

POINT

If the input range extended mode function, scaling function (for A/D conversion), and shifting function (for A/D conversion) are used simultaneously, the scaling value can exceed the range from -32768 to 32767.

In such a case, the values set within the upper limit (32767) and lower limit (-32767) values will be stored into the buffer memory as scaling values.

(3) Disconnection detection

Combining the input range extended mode function and input signal error detection function detects a disconnection.

If the input analog current value changes to 2mA or less, or the input analog voltage value changes 0.5V or less, an external wiring is disconnected, and CH1 Input signal error detection flag (Un\G114) is set to on (1).

(a) Setting methods

- 1) Disconnection detection can be performed only when the input range is set to either:
 - 4 to 20mA (Extended mode)
 - 1 to 5V (Extended mode)
- 2) To use the disconnection detection function, set CH1 Input signal error detection setting (Un\G20) to detect disconnections (4), and set Operating condition setting request (Y9) to on.

(b) Operation for disconnection detection

- 1) If the conditions described in Table 4.5 are satisfied, the following operations perform.
 - Input signal error detection signal (X7) is set to on.
 - CH1 Input signal error detection flag (Un\G114) is set to on (1).
 - ALM LED blinks.

To disable the above operations, cancel the conditions of disconnection detection shown in Table 4.5 and set Error clear request (YF) to on.

Table 4.5 Condition of disconnection detection

Input range	Condition of disconnection detection
4 to 20mA (Extended mode)	Input analog value \leq 2mA
1 to 5V (Extended mode)	Input analog value \leq 0.5V

- 2) A digital output value immediately before the disconnection detections is held for CH1 Digital output value (Un\G100), and CH1 A/D conversion completed flag (Un\G113) is set to off (0).
- 3) When the disconnection is restored, A/D conversion resumes independently and CH1 A/D conversion completed flag (Un\G113) is set to on (1) after the first updating.

POINT

The disconnection detection is executed at every sampling processing regardless of the status of CH1 Averaging process method setting (Un\G1).

[Example] When the number of conversion enabled channels is three, the disconnection detection is executed every 1.5ms.

$$500 \mu s \times 3CH = 1500 \mu s \rightarrow 1.5ms$$

4.2.7 Logging function

(1) Logging function

This function collects the data of the digital output value or scaling value performed A/D conversion at a preset timing in series.

This function is useful to check the data change of the digital output value or scaling value performed A/D conversion periodically because the function sets an interval (logging period), performs logging, and stores the logs into the buffer memory.

In addition, this function is useful to check the data change of the analog input value during the stopped logging, if a trigger condition is set by using a hold trigger.

(2) Logging operation

When logging starts in sequence programs, logging data are stored into the logging data storage areas in order from the initial area.

Logging data can be stored up to 10000th data point area for a channel.

The stored data are retained until when the CPU module is powered off or Operating condition setting request (Y9) is set to on.

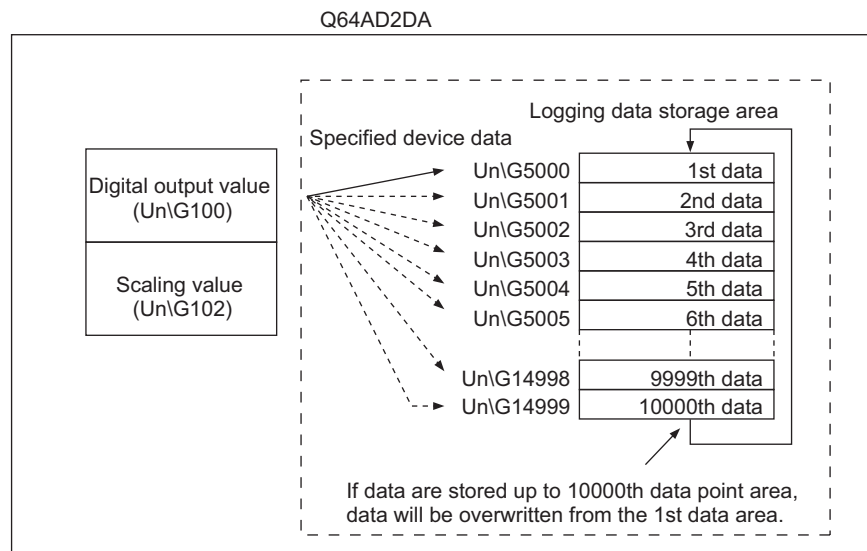

Figure 4.8 Logging operation

(3) Logging start

To use a logging facility, the following items are required for the initial setting.

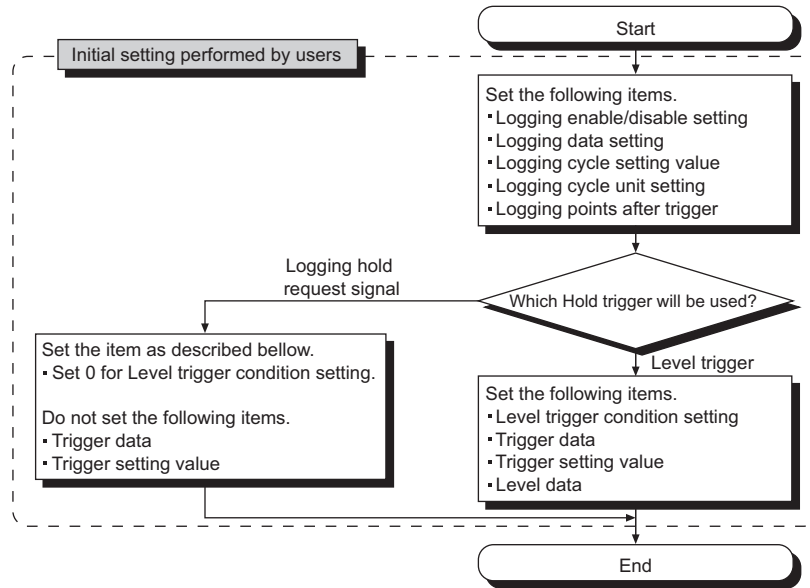

Figure 4.9 Flowchart of initial setting

(a) Common setting items

To use a logging facility, set the items shown in Table 4.6.

Table 4.6 Initial setting for logging facility

Item	Description	Reference section
Logging enable/disable setting	Set the item to be enabled (0).	Section 6.10
Logging data setting	Set whether to perform logging digital output values or scaling values.	Section 6.12
Logging cycle	Set the cycle to store data during logging.	Section 6.11
Logging points after trigger	Set the amount of logging data after hold triggers are detected and before logging is held.	Section 6.13

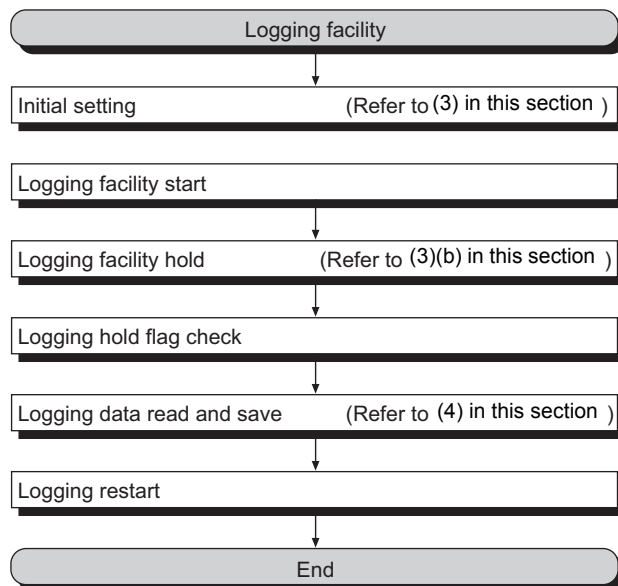

Figure 4.10 Flowchart of operating procedure

(b) Hold trigger

Hold trigger is the trigger that occurs for the case of preset trigger conditions to be met when a logging facility is used.

When the Q64AD2DA detects a hold trigger, the logging facility stops (hold) collecting logging data after logging the number of preset points.

The necessary setting items vary depending on hold triggers to be used. Select one of two types of hold trigger.

1) For holding logging in given timing

A hold trigger is detected by using Logging hold request (Y1).

Setting CH1 Logging hold request (Y1) to on holds the logging.

Table 4.7 For detecting hold triggers by using Logging hold request

Item	Description	Reference section
Level trigger condition setting	Set the item to be "Disable" (0).	Section 6.14

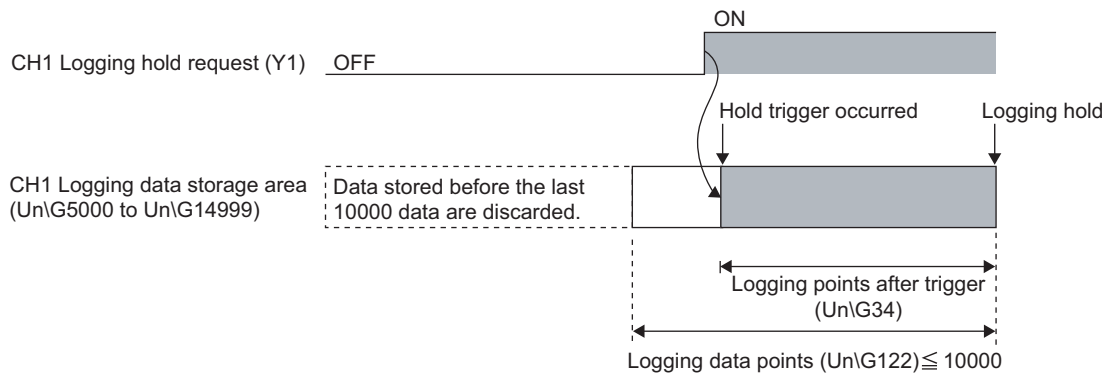

Figure 4.11 For detecting hold triggers by using Logging hold request

2) For holding logging when given buffer memory meet the setting conditions

A hold trigger is detected by using a level trigger.

Setting CH1 Logging hold request (Y1) to on causes the logging data to be trigger condition waiting status set in Table 4.8, and the satisfied trigger condition holds the logging.

Table 4.8 For detecting hold triggers by using level triggers

Item	Description	Reference section
Level trigger condition setting	Set a condition for using level triggers.	Section 6.14
Trigger data	Set an address of the buffer memory monitoring data to make level triggers work.	Section 6.15
Trigger setting value	Set a value that makes level triggers work.	Section 6.16
Level data	This data is the data that monitor data to make level triggers work. Set this level data to monitor devices specified for CPU modules or the like excluding the buffer memory of the Q64AD2DA and make triggers work.	Section 6.38

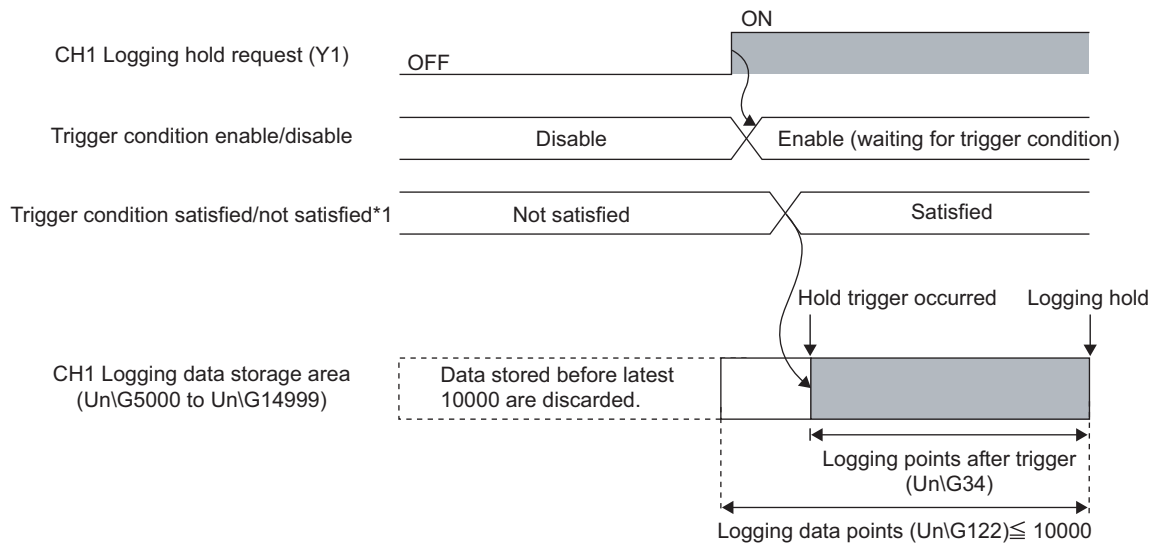

* 1 A hold trigger occurs when the condition set in Table 4.8 is satisfied.

Figure 4.12 For detecting hold triggers by using level triggers

☒ POINT

- (1) If logging does not start, check the following:
 - Is CH1 Logging enable/disable setting (Un\G30) set to be disabled (1)?
If CH1 Logging enable/disable setting (Un\G30) has been set to be disabled (1), set CH1 Logging enable/disable setting (Un\G30) to be enabled (0).
 - Is the initial setting correct?
If the initial setting has an error, Error flag (XF) is set to on and ERR. LED lights up.
Reconfigure the initial setting, referring to the error code. (refer to Section 11.1.)
 - (2) If Operating condition setting request (Y9) is set to on during logging, the logging will stop whether hold triggers are executed or not and all the stored logging data will be cleared before Operating condition setting request (Y9) is set to on.
-

(4) Reference of logging data

If CH1 Logging hold flag (X1) is set to on, refer to the buffer memory shown in Figure 4.13 and Figure 4.14.

The logging datad point determines how to refer to the logging data storage area.

[Example] The held logging data point is 10000.

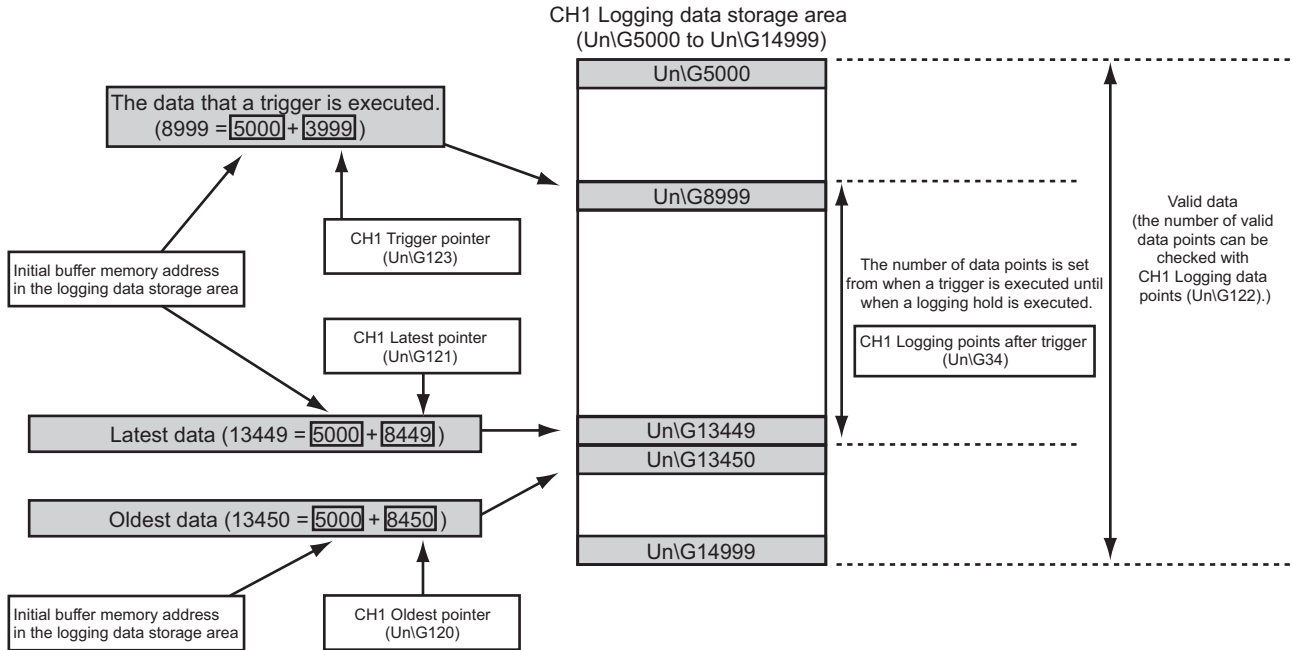

Figure 4.13 The held logging data point is 10000.

[Example] The held logging data point is less than 10000.

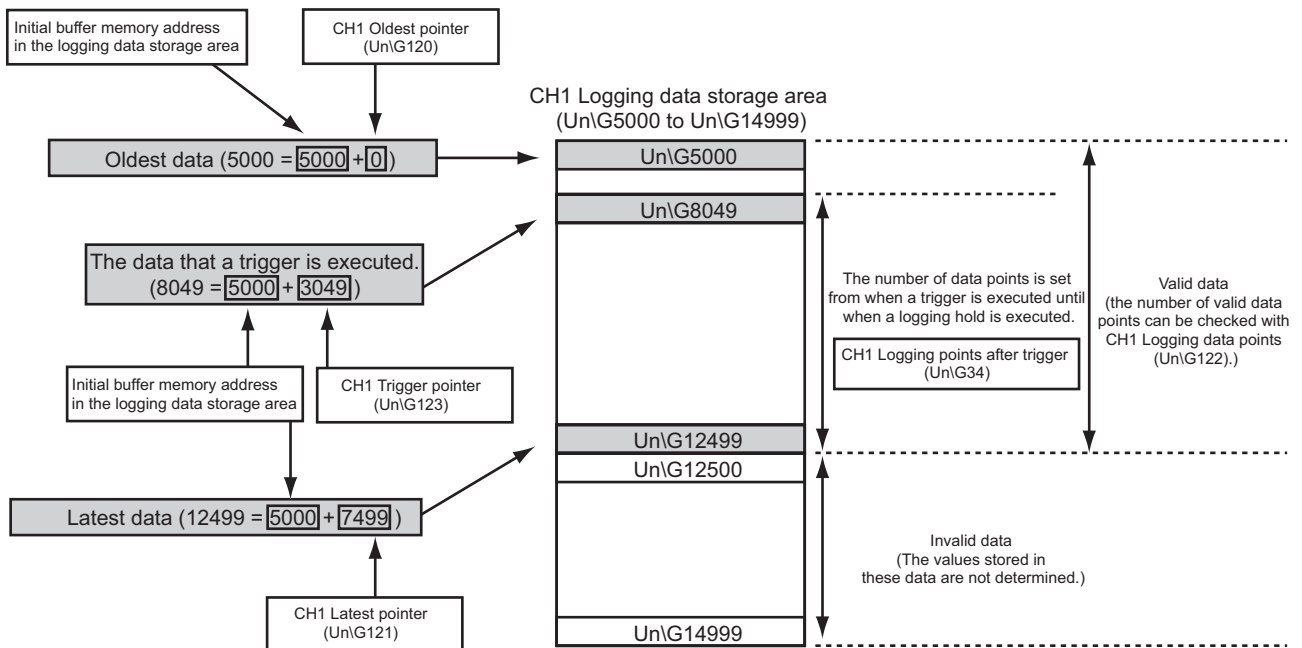

Figure 4.14 The held logging data point is less than 10000.

POINT

- (1) If CH1 Logging hold request (Y1) is set to off before CH1 Logging hold flag is set to on, logging will restart without hold after logging of data that set for logging points after trigger will start.
- (2) From when CH1 Logging hold request (Y1) is set to on until when a hold trigger occurs in the Q64AD2DA, the delay is up to the time calculated as shown below.
 - Trigger occurrence delay = (Number of channels that conversion is enabled × 500 μs) + (Scan time for CPU modules)

(5) Referring to logging data without logging hold

Logging data can be checked without logging hold.

- (a) Buffer memory to be used

Table 4.9 Buffer memory required for referring to logging data

Item	Description	Reference Section
Oldest pointer	The address of the buffer memory that store the oldest data can be checked in the logging data storage area.	Section 6.24
Latest pointer	The address of the buffer memory that store the latest data can be checked in the logging data storage area.	Section 6.25
Logging data points	The number of data stored in the logging data storage area can be checked.	Section 6.26

- (b) Precautions

To refer to logging data during data logging, pay attention to the following.

- 1) Logging cycle setting

Before logging data are updated, set a cycle allows data to be referred and collected, completely and securely.

- 2) Reference timing

After the number of logging data to be referred is collected, the oldest pointer or the change of the logging data points must be monitored and logging data must be obtained according to the change of the storage values.

POINT

If the relationship between the logging cycle and the scan time of the CPU modules causes data not to be updated and referred simultaneously, adjust the logging cycle.

A short logging cycle may cause logging data to be updated in referring or collecting data.

To refer to data regardless of the logging cycle, perform logging hold.

4.3 Function Details of D/A Conversion

4.3.1 D/A output enable/disable function

Set whether D/A conversion values are output or offset values are output for each channel.

(1) Setting methods

CH5 Output enable/disable flag (Y5) can be used.

Table 4.10 D/A output enable/disable function

CH5 Output enable/disable flag (Y5)	Analog output
Output enabled (ON)	Outputs D/A conversion values.
Output disabled (OFF)	Outputs offset values.

(2) D/A output enable/disable function and the conversion speed

The conversion speed is calculated by the formula ($500 \mu s \times$ Number of channels of conversion enabled) regardless of whether CH5 Output enable/disable flag (Y5) is enabled (ON) or disabled (OFF).

4.3.2 Analog output HOLD/CLEAR function

For the case where the CPU module is placed in STOP or in a stop error status, whether to hold (HOLD) or clear (CLEAR) the analog output value can be set.

(1) Setting methods

Set the HOLD/CLEAR in "Switch 3" cell of Switch setting for I/O and intelligent function module dialog box. (Refer to Section 7.5.2.)

(2) Analog output status combination

Depending on combinations of the HOLD/CLEAR setting, CH5 D/A conversion enable/disable setting (Un\G800), and CH5 Output enable/disable flag (Y5), the analog output status varies as shown in Table 4.11.

Table 4.11 Analog output status combination list

Execution status	Setting combination				
	CH5 D/A conversion enable/disable setting (Un\G800)	Enable		Disable	
		CH5 Output enable/disable flag (Y5)	Enable	Disable	Enable or disable
	Analog output HOLD/CLEAR setting function setting		HOLD	CLEAR	HOLD or CLEAR
Analog output status when a CPU module is RUN		Outputs analog values converted from digital input values.		Offset	0V/0mA
Analog output status when a CPU module is STOP		Hold	Offset	Offset	0V/0mA
Analog output status when a CPU module stop error occurs		Hold	Offset	Offset	0V/0mA
Analog output status when a watchdog timer error* ¹ occurs in the Q64AD2DA		0V/0mA	0V/0mA	0V/0mA	0V/0mA

* 1 This occurs when program operations are not completed within the scheduled time due to a hardware problem of the Q64AD2DA. When a watchdog timer error occurs, Module ready (X0) is set to off and the Q64AD2DA RUN LED is turned off.

POINT

The following conditions should be satisfied when the analog output HOLD/CLEAR function is used on a MELSECNET/H remote I/O station.

- The master module of function version D or later and the remote I/O module of function version D or later are required.
- Validate the station unit block guarantee of the send side cyclic data.
- The setting for holding the Q64AD2DA output in the case of a link error must be made in the "Error time output mode in the I/O assignment setting". (Refer to Section 7.5.1 (2).) At this time, the HOLD/CLEAR setting in "Switch 3" of Switch setting for I/O and intelligent function module dialog box is not reflected. This setting is validated on a per-module basis, and is not made on a per-channel basis. Therefore, to make the output status at a stop error or STOP of the CPU module matched with the output status at a link error, set the same HOLD/CLEAR function setting to all channels. (Refer to Table 4.12.)

Table 4.12 Analog output HOLD/CLEAR function of MELSECNET/H remote I/O station

Hold/Clear of analog output value	Error time output mode	HOLD/CLEAR function setting (Same setting to all channels)
Hold analog output	Hold	HOLD
Clear analog output (Output offset value)	Clear	CLEAR

For the station unit block guarantee of the cyclic data, refer to the following manual.

- Q Corresponding MELSECNET/H Network System Reference Manual (Remote I/O network)

4.3.3 Analog output test during a CPU module STOP

While the CPU module is in stop status, an analog output test as shown can be performed. (Refer to Table 4.13.)

(1) Operating method

To conduct an analog output test, perform the following on Device test of GX Developer, on the relevant test screens of Configurator-AD, or Configurator-DA. (Refer to Section 8.6.1.)

The operating procedure is as follows:

- 1) Set CH5 D/A conversion enable/disable (Un\G800) where the test is to be conducted to Enable (0).
- 2) Turn Operating condition setting request (Y9) from off to on.
- 3) Check that Operating condition setting completed flag (X9) turns off, and then turn Operating condition setting request (Y9) from on to off.
- 4) Set CH5 Output enable/disable flag (Y5) to be tested to be enabled (to on).
- 5) Set digital input values equivalent to analog values that are to be output to CH5 Digital input value (Un\G802).

Table 4.13 List of analog output test

Setting combination	CH5 D/A conversion enable/disable setting (Un\G800)	Enable		Disable	
	CH5 Output enable/disable flag (Y5)	Enable	Disable	Enable	Disable
Analog output test		Allowed	Not allowed	Not allowed ^{*1}	

* 1 Perform the analog output test after changing CH5 D/A conversion enable/disable setting (Un\G800) to be enabled (1).

(2) Operating timing

While the CPU module is in stop status, the relationship between CH5 Output enable/disable flag (Y5) and the analog output value are shown below.

D/A conversion output is executed even when the programmable controller CPU stops.

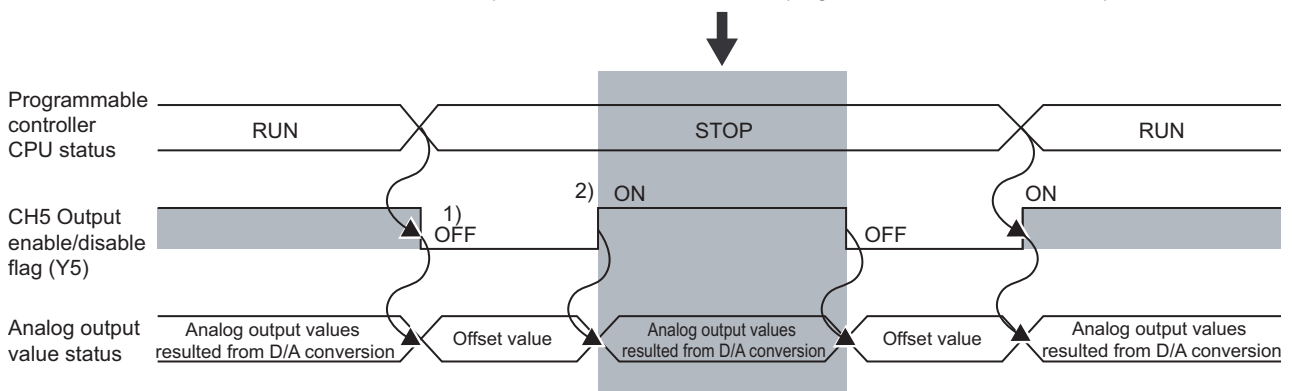

Figure 4.15 Analog output value during the stop status of the CPU module

Table 4.14 Details of the analog output value during the stop status of the CPU module

Number	Description
1)	CH5 Output enable/disable flag (Y5) is set to off.
2)	When CH5 Output enable/disable flag (Y5) is set to on forcibly, the offset value of the analog output value changes to the analog output value that D/A conversion is performed.

4.3.4 Scaling function (D/A conversion)

This function changes an input range of digital input values to a given range between -32000 and 32000.

(1) Overview

- (a) Whether using the scaling function (D/A conversion) for each channel or not can be specified with CH5 D/A conversion scaling enable/disable setting (Un\G810).
- (b) The scaling function performs scaling conversion of the digital output values set with CH5 Digital input value (Un\G802) within the range set by the buffer memory.
 - CH5 D/A conversion scaling lower limit value (Un\G811)
 - CH5 D/A conversion scaling upper limit value (Un\G812)
- (c) The fractional portion of the digital input value converted with scaling function is rounded off.
 CH5 Real conversion digital value (Un\G902) indicates a digital input value that scaling and shifting are performed. (Refer to Section 4.3.5.)

(2) Setting methods

- 1) Set the buffer memory as follows:
 - Setting CH5 D/A conversion scaling enable/disable setting (Un\G810) to be enabled (0).
 - Setting a digital input value corresponding to the upper limit^{*1} of analog output as the scaling upper limit value set with CH5 D/A conversion scaling upper limit value (Un\G812).
 - Setting a digital input value corresponding to the lower limit^{*2} of analog output as the scaling lower limit value set with CH5 D/A conversion scaling lower limit value (Un\G811).

* 1 Input range from -10 to 10V, normal resolution: 4000

* 2 Input range from -10 to 10V, normal resolution: -4000

- 2) Set Operating condition setting request (Y9) to on.

(3) How to calculate a scaling value

For the D/A conversion, the value to be calculated with the following formula will be used.

(If the value cannot be divided, the fractional portion of the digital value will be rounded off.)

$$\text{Digital values used for D/A conversion} = \frac{D_{\text{Max}} - D_{\text{Min}}}{S_{\text{H}} - S_{\text{L}}} \times (D_{\text{x}} - S_{\text{L}}) + D_{\text{Min}}$$

- D_x : CH5 Digital input value (Un\G802)
- D_{Max} : The maximum digital input value in the output range being used
- D_{Min} : The minimum digital input value in the output range being used
- S_H : CH5 D/A conversion scaling upper limit value (Un\G812)
- S_L : CH5 D/A conversion scaling lower limit value (Un\G811)

[Setting example]

Using the scaling function (D/A conversion) in input range from -10 to 10V and high resolution mode (from -16000 to 16000)

(a) Setting value

- CH5 D/A conversion scaling upper limit value (Un\G812) SH: 14000
- CH5 D/A conversion scaling lower limit value (Un\G811) SL: 2000

(b) Input value

Digital input value Dx: 7000

Digital values used for D/A conversion

$$\begin{aligned}
 &= \frac{16000 - (-16000)}{14000 - 2000} \times (7000 - 2000) + (-16000) \\
 &= -2666.66 \dots \\
 &= -2667
 \end{aligned}$$

Fractional portion is rounded off.

(4) Settable range

If the scaling function (D/A conversion) is used, the digital input values of the upper limit*1 and lower limit*1 of the settable range are as follows:

- Settable upper limit value = D/A conversion scaling upper limit value + A
- Settable lower limit value = D/A conversion scaling lower limit value - A'

A and A' depends on a resolution mode, output range, D/A conversion scaling upper limit value, and D/A conversion scaling lower limit value. (Refer to Figure 4.16.)

[Setting example]

Setting example
 Output range: 0 to 5V
 Resolution mode: High resolution mode (0 to 12000)
 CH5 D/A conversion scaling lower limit value (Un\G811): 1000
 CH5 D/A conversion scaling upper limit value (Un\G812): 6000

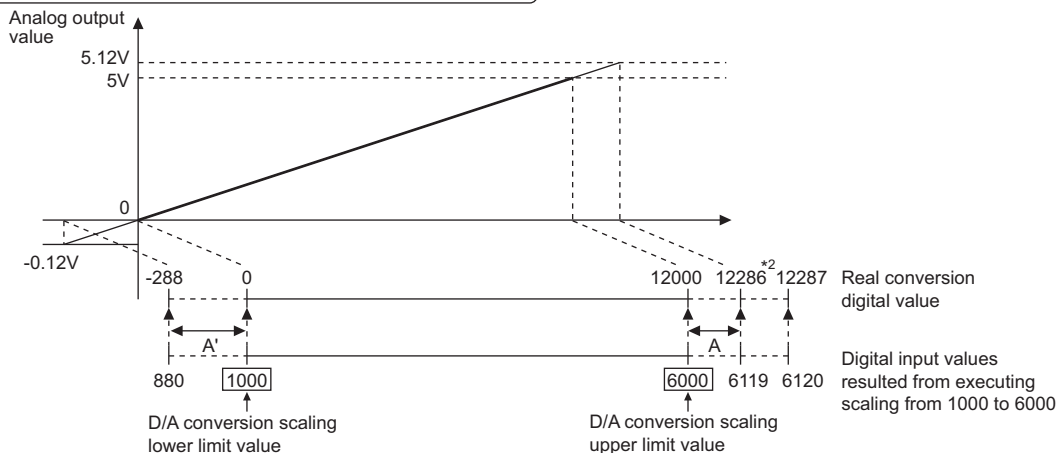

Figure 4.16 Settable range of digital input values

* 1 This value is a value that does not cause Digital value out of range error (error code: □ 003).
 * 2 This setting example shows 6119 as a settable upper limit value and the real conversion digital value is 12286. Therefore, the analog output value corresponding to the real conversion digital value 12287 will not be output.

As indicated in the formula of (4) in this section or Figure 4.16, the value exceeding the D/A conversion scaling upper limit or the value that falls below the D/A conversion lower limit can be set for a digital input value. However, the analog output value corresponding to the real conversion digital value, exceeding the range cannot be ensured.

Moreover, when setting the values of settable upper and lower limits, the real conversion digital value could not reach the maximum or minimum value.

(5) Precautions

(a) Use of scaling function (D/A conversion) and resolution

Even if the digital input value range is enlarged with the scaling function (D/A conversion), the resolution will not be more than the one applied when the scaling function is not used.

As the digital input value range is narrowed, the resolution is lowered.

(b) When a digital input value range not including zero (0), such as 1000 to 6000, is specified

When a digital input value range not including zero (0), such as 1000 to 6000, is specified, set CH5 Output enable/disable flag (Y5) to on after setting values within the input range in CH5 Digital input value (Un\G802).

If CH5 Output enable/disable flag (Y5) is set to on with the default value (0) set in CH5 Digital input value (Un\G802), an error (error code: □003) will occur.

[Setting example]

The following setting causes an error (error code: □003).

Setting example

- Output range: 0 to 5V
- Resolution mode: High resolution mode (0 to 12000)
- CH5 D/A conversion scaling lower limit value (Un\G811): 1000
- CH5 D/A conversion scaling upper limit value (Un\G812): 6000

CH5 Output enable/disable flag (Y5) is turned on when CH5 Digital input value (Un\G802) is in initial value (0) status.
 Digital values used for D/A conversion

$$= \frac{12000 - 0}{6000 - 1000} \times (0 - 1000) + 0$$

$$= -2400$$

Since this digital input value is out of the scaling range (1000 to 6000) set, an error (error code: □003) occurs.

Figure 4.17 Example of setting range

(c) The settable range of the values, that scaling conversion is performed for digital values set in CH5 Digital input value (Un\G802), can be checked.

4.3.5 Shifting function (D/A conversion)

The shifting function adds a setting quantity to a digital input value (shifting a analog output value).

(1) Overview

- The shifting amount to input value can be set within the range from -32768 to 32767.
- If a scaling function (for D/A conversion) is used simultaneously, scaling will be performed after shifting.
- If the shifted values exceed the range from -32768 to 32767, the values will be fixed to the upper limit (32767) and lower limit (-32768), respectively.
- CH5 Real conversion digital value (Un\G902) indicates a digital input value that scaling and shifting are performed. (Refer to Section 4.3.4.)
- If the shifted values exceed the settable digital ranges corresponding to the set output ranges, the D/A conversion will be performed according to Table 4.15.
- Changing the shifting amount to input value reflects the analog output value in real time. Therefore, the analog output value can be adjusted with the shifting function when the CPU is powered on.

Table 4.15 Settable range corresponding to the output ranges and processing of digital values exceeding settable range

Output range setting	Normal resolution mode		High resolution mode	
	Settable range (Real range)	Processing for the case of written digital values exceeding settable range	Settable range (Real range)	Processing for the case of written digital values exceeding settable range
0H: 4 to 20mA	-96 to 4095 (Real range: 0 to 4000)	4096 or more: 4095 -97 or less: -96	-288 to 12287 (Real range: 0 to 12000)	12288 or more: 12287 -289 or less: -288
1H: 0 to 20mA				
2H: 1 to 5V				
3H: 0 to 5V	-4096 to 4095 (Real range: -4000 to 4000)	4096 or more: 4095 -4097 or less: -4096	-16384 to 16383 (Real range: -16000 to 16000)	16384 or more: 16383 -16385 or less: -16384
4H: -10 to 10V				

(2) Setting methods

- Set the quantity to be shifted by using CH5 Shifting amount to input value (Un\G813).
- Shifting quantities are added to the digital input value set with CH5 Digital input value (Un\G802) every conversion period.
- The default of the shifting amount to input value is 0.
- If a value is written to a shifting amount to input value, regardless of whether Operating condition setting request (Y9) is set to on or off, the shifting amount to input value will be added to digital input value.

(3) Setting example

For the channel in setting the output range to 0 to 20mA and the high resolution mode (to 0 to 4000), I/O characteristic is adjusted as shown below.

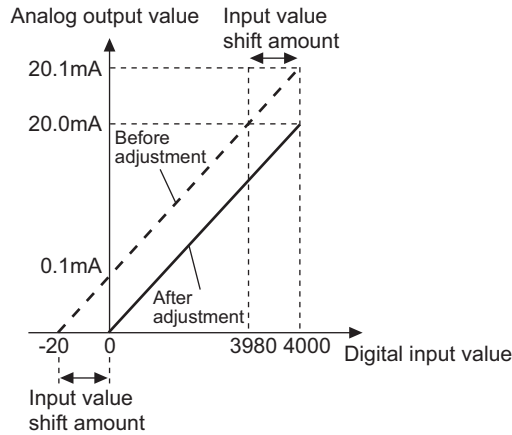

Figure 4.18 I/O characteristic after shifting processing

Table 4.16 Digital input value after shifting processing

CH5 Digital input value (Un\G802)	Output current (mA)	CH5 Digital input value (Un\G802)	Output current (mA)
0	0.1	0	0.0
4000	20.1	4000	20.0

For the case of above example, set CH5 Shifting amount to input value (Un\G813) to -20.

Before and after the shifting processing, the digital input value, real conversion digital value, and analog output value are as follows:

Table 4.17 Shifting processing

CH5 Digital input value (Un\G802)	CH5 Real conversion digital value (Un\G902)	Output current (mA)	CH5 Shifting amount to input value (Un\G813)
-20	-20	0.0	0
0	0	0.1	
3980	3980	20.0	
4000	4000	20.1	
↓			
CH5 Digital input value (Un\G802)	CH5 Real conversion digital value (Un\G902)	Output current (mA)	CH5 Shifting amount to input value (Un\G813)
0	-20	0.0	-20
20	0	0.1	
4000	3980	20.0	
4020	4000	20.1	

4.4 Details of Common Function

4.4.1 Analog conversion enable/disable setting

(1) Analog conversion enable/disable setting and conversion speed

Set whether A/D or D/A conversion for the A/D conversion channels (CH1 to CH4) and D/A conversion channels (CH5, CH6) is enabled or disabled for each channel. The Q64AD2DA conversion speed is calculated with the formula, $500 \mu s \times \text{Number of conversion enabled channels}$.

The Q64AD2DA converts according to the two types of the conversion sequence, group 1 and group 2.

Table 4.18 Conversion sequence of A/D conversion channels and D/A conversion channels

Group	A/D conversion channel		D/A conversion channel
Group 1	CH1	CH2	CH5
Group 2	CH3	CH4	CH6

(2) Conversion sequence

The sequence of the analog conversion depends on the channels that enable conversion as shown below.

(a) Sequence of the analog conversion for the case of the all channels that enable conversion

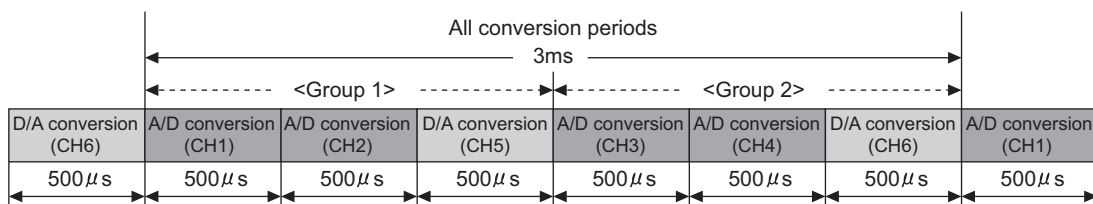

Figure 4.19 Sequence of the analog conversion for all channels that enable conversion

(b) Sequence of the analog conversion for the case of CH1, CH3, and CH5 enable conversion

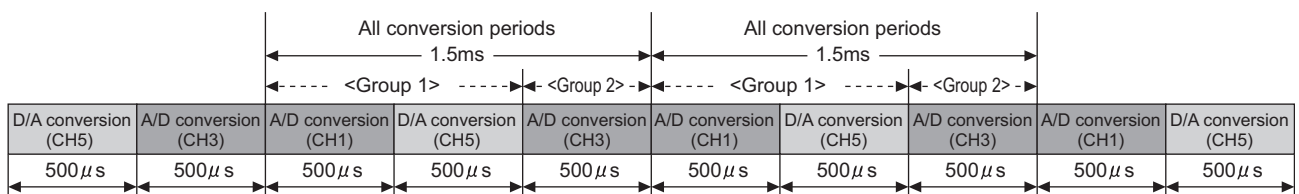

Figure 4.20 Sequence of the analog conversion for the case of CH1, CH3, and CH5 enable conversion

CHAPTER5 I/O SIGNALS FOR THE CPU MODULE

5.1 List of I/O Signals

Table 5.1 lists the I/O signals of the Q64AD2DA.

Note that I/O numbers (X/Y) shown in this chapter and thereafter are the values when the start I/O number for the Q64AD2DA is set to 0.

Table 5.1 List of I/O signal

Signal direction CPU module ← Q64AD2DA		Signal direction CPU module → Q64AD2DA	
Device number (input)	Signal name	Device number (output)	Signal name
X0	Module ready	Y0	Use prohibited*1
X1	CH1 Logging hold flag	Y1	CH1 Logging hold request
X2	CH2 Logging hold flag	Y2	CH2 Logging hold request
X3	CH3 Logging hold flag	Y3	CH3 Logging hold request
X4	CH4 Logging hold flag	Y4	CH4 Logging hold request
X5	Use prohibited*1	Y5	CH5 Output enable/disable flag
X6	External power off flag	Y6	CH6 Output enable/disable flag
X7	Input signal error detection signal	Y7	Use prohibited*1
X8	High resolution mode status flag	Y8	
X9	Operating condition setting completion flag	Y9	Operating condition setting request
XA	Use prohibited*1	YA	Use prohibited*1
XB		YB	
XC		YC	
XD	Maximum and minimum values reset completion flag	YD	Maximum and minimum values reset request
XE	A/D conversion completed flag	YE	Use prohibited*1
XF	Error flag	YF	Error clear request

POINT

*1 These signals cannot be used by the user since they are for system use only. If these are set to on or off by the sequence program, the performance of the Q64AD2DA cannot be guaranteed.

5.2 Details of I/O Signals

I/O signals for the Q64AD2DA are explained in detail below.

Device numbers (X/Y) and buffer memory address shown in this chapter are for CH1 (the device number and buffer memory address used only for the D/A conversion are CH5.).

For the device numbers and buffer memory used for other channels, refer to Section 5.1 and Section 6.1.

5.2.1 Input signals

(1) Module ready (X0)

- (a) When the CPU module is powered on or reset, this signal is set to on once the preparation for A/D conversion or D/A conversion has been completed.
- (b) When a hardware error (error code:1) occurs, Module ready (X0) is set to off and RUN LED is turned off.

In such a case, A/D conversion and D/A conversion are not performed.

(2) CH1 Logging hold flag (X1)

For the input signals of CH2 or later, refer to Section 5.1.

(a) If the logging is held, CH1 Logging hold flag (X1) will be set to on. The following shows the timing for the logging to be held.

1) A hold trigger detection with Logging hold request signal

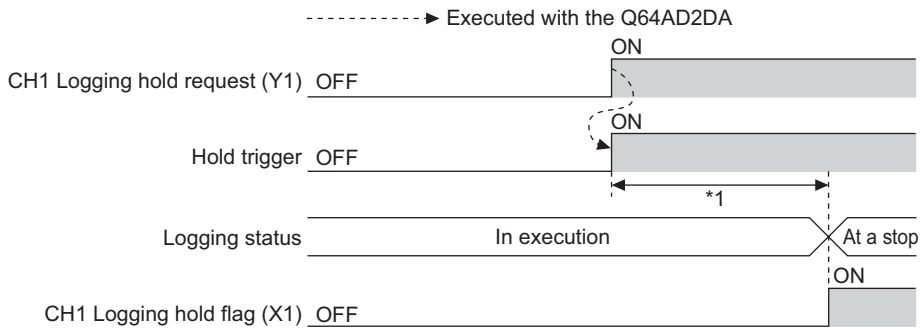

* 1 Logging points after trigger

Figure 5.1 A hold trigger detection with Logging hold request signal

2) A hold trigger detection with Level trigger

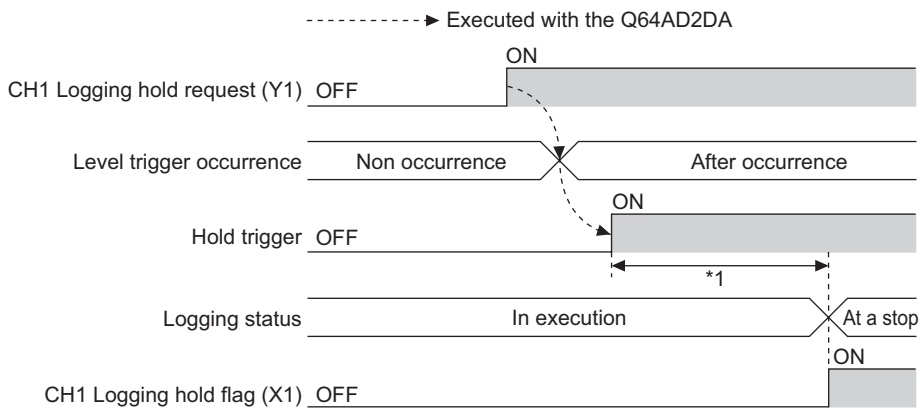

* 1 Logging points after trigger

Figure 5.2 A hold trigger detection with Level trigger

(b) If the logging restarts by setting CH1 Logging hold request (Y1) to off, CH1 Logging hold flag (X1) will be set to off.

(3) External power off flag (X6)

- (a) If an external power supply is not turned on, External power off flag (X6) will be set to on.
- (b) If External power off flag (X6) is set to on, the following processing will be performed.
- 1) Even if a conversion setting is enabled for each channel and Operating condition setting request (Y9) is set to on or off, A/D conversion or D/A conversion will not be performed.
 - 2) The analog output values will be 0mA or 0V regardless of the other settings.
 - 3) Digital input value out of range error (error code: □003) will not be detected.
 - 4) The value 0 (not used or first A/D conversion completed) will be stored into CH1 A/D conversion completed flag (Un\G113) (CH1 to CH4).
 - 5) In such a case, the digital output values and scaling values converted immediately before External power off flag (X6) is set to on will be retained.
- (c) The external power supply will cause the following processing.
- 1) A/D conversion and D/A conversion will restart.
 - 2) After the restart, the value 1 (first A/D conversion completed) will be stored into CH1 A/D conversion completed flag (Un\G113) for the channels (CH1 to CH4) again.
- (d) To set External power off flag (X6) to off, the following procedure must be conducted.
- 1) Set Error clear request (YF) to on.
 - 2) After checking that External power off flag (X6) is set to off, set Error clear request (YF) to off.
- (e) The external power supply must be satisfied with the request of the performance specifications (Refer to Table 3.1.).
If not, External power off flag (X6) may be set to on.
- (f) When the external power supply is turned on after the CPU module is powered on, the timing diagram is as follows:

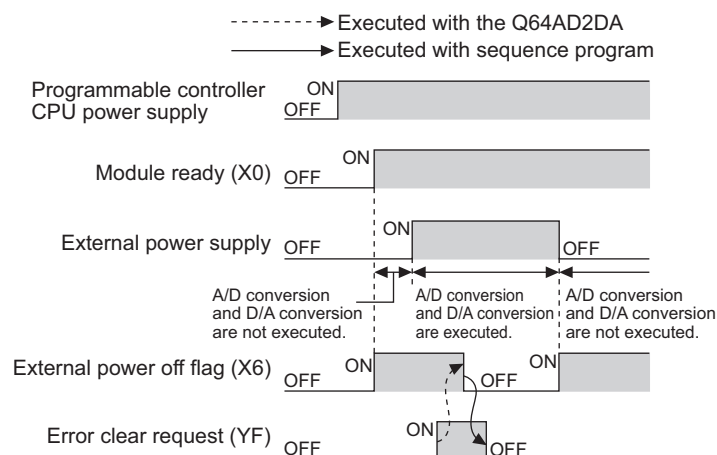

Figure 5.3 Timing diagram for the case of turned on external power supply after the CPU module is powered on

- (g) Set Module ready (X0) to on and External power off flag (X6) to off for digital or analog outputs as shown below.



Figure 5.4 Program example for the case of digital or analog outputs

(4) Input signal error detection signal (X7)

- (a) This signal is set to on when the analog input value falls outside the range of the input signal error detection setting value for CH1 Input signal error detection setting value (Un\G21) on any of the channels enabled for A/D conversion after the input signal error detection for CH1 Input signal error detection setting (Un\G20) is made valid (any of 1 to 4).
- (b) Setting Input signal error detection signal (X7) to on causes the following processing.
- 1) The value 0 (not used or in first A/D conversion) will be stored into CH1 A/D conversion completed flag (Un\G113).
 - 2) Digital output values of the corresponding channel will be held at the immediately preceding value of error detection.
 - 3) ALM LED will blink.
- (c) To restart A/D conversion, bring the analog input value within the setting range and set Error clear request (YF) to on. Consequently, Input signal error detection signal (X7) will be set to off, ALM LED will be turned off, and A/D conversion will be resumed. Unless Error clear request (YF) is set to on, A/D conversion will be resumed when the analog input value returns to within the setting range. However, Input signal error detection signal (X7) set to on and the blinking ALM LED will not be canceled.
- (d) After the first updating, the value 1 (first A/D conversion completed) will be stored into CH1 A/D conversion completed flag (Un\G113) again. The averaging processing will start from the first time after resumption of A/D conversion.

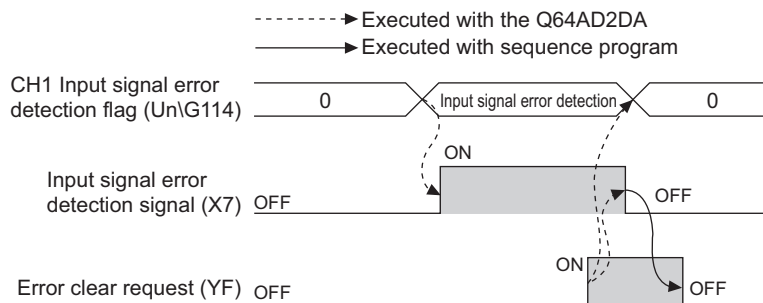

Figure 5.5 Timing diagram of CH1 Input signal error detection signal (X7)

(5) High resolution mode status flag (X8)

This flag is set to on when the high resolution mode is set in "Switch 4" of Switch setting for I/O and intelligent function module dialog box. (Refer to Section 7.5.2.)

(6) Operating condition setting completion flag (X9)

(a) This signal is used as an interlock condition to set Operating condition setting request (Y9) to on or off when any of the following settings has been changed.

- CH1 A/D conversion enable/disable setting (Un\G0)
- CH5 D/A conversion enable/disable setting (Un\G800)
- CH1 Averaging process method setting (Un\G1)
- CH1 Averaging process (time / number of times) setting (Un\G2)
- CH1 A/D conversion scaling enable/disable setting (Un\G10)
- CH1 A/D conversion scaling lower limit value (Un\G11)
- CH1 A/D conversion scaling upper limit value (Un\G12)
- CH5 D/A conversion scaling enable/disable setting (Un\G810)
- CH5 D/A conversion scaling lower limit value (Un\G811)
- CH5 D/A conversion scaling upper limit value (Un\G812)
- CH1 Input signal error detection setting (Un\G20)
- CH1 Input signal error detection setting value (Un\G21)
- CH1 Logging enable/disable setting (Un\G30)
- CH1 Logging cycle setting value (Un\G31)
- CH1 Logging cycle unit setting (Un\G32)
- CH1 Logging data setting (Un\G33)
- CH1 Logging points after trigger (Un\G34)
- CH1 Level trigger condition setting (Un\G35)
- CH1 Trigger data (Un\G36)
- CH1 Trigger setting value (Un\G37)

(b) If Operating condition setting completed flag (X9) is set to off, A/D conversion processing will not performed.

(c) Under the following conditions, Operating condition setting completed flag (X9) will be set to off.

- When Operating condition setting request (Y9) is set to on

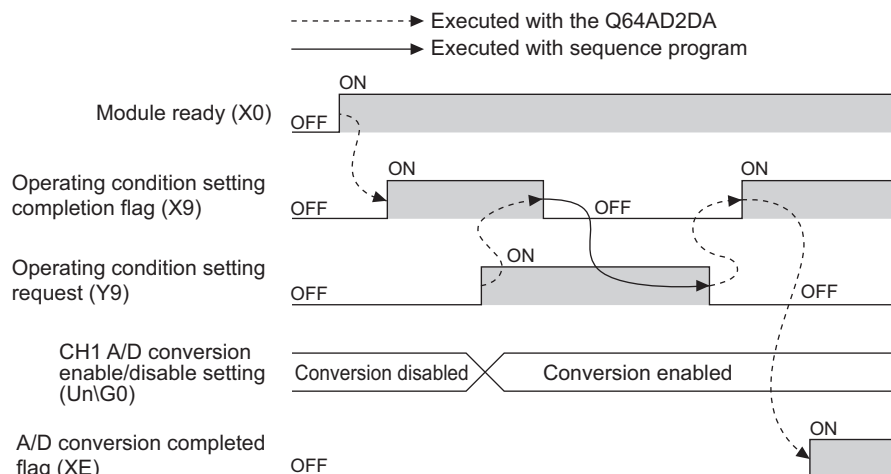

Figure 5.6 Timing diagram of Operating condition setting completion flag (X9)

(7) Maximum and minimum values reset completion flag (XD)

This flag will be set to on when the maximum value and minimum value stored into the following buffer memory reset by setting Maximum and minimum values reset request (YD) to on.

- CH1 Maximum digital output value (Un\G104)
- CH1 Minimum digital output value (Un\G106)
- CH1 Maximum scaling value (Un\G108)
- CH1 Minimum scaling value (Un\G110)

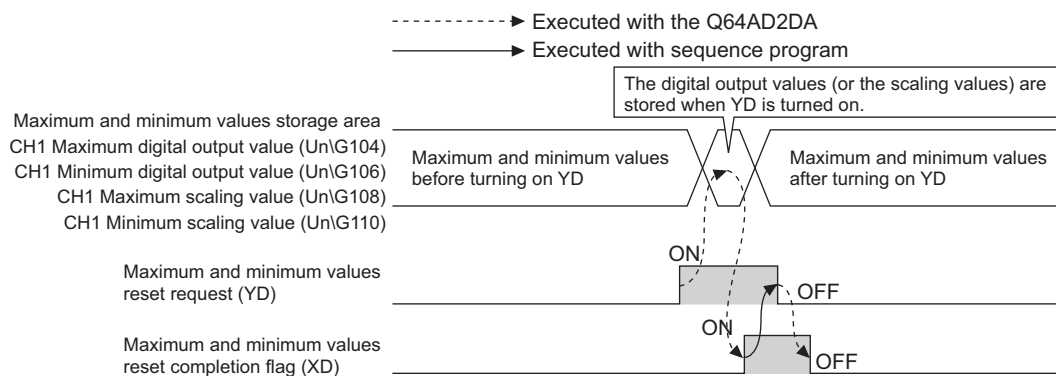

Figure 5.7 Timing diagram of Maximum and minimum values reset completion flag (XD)

(8) A/D conversion completed flag (XE)

(a) This flag will be set to on when first conversions for each channel^{*1} that A/D conversion is enabled has been completed.

* 1 Not relevant to the channels that D/A conversion is enabled

(b) If the external power supply for the Q64AD2DA turns off, A/D conversion completed flag (XE) will flow as shown in the section of External power off flag (X6). (Refer to Section 5.2.1 (3).)

(c) When reading the digital output values, use A/D conversion completed flag (XE) or CH1 A/D conversion completed flag (Un\G113) as an interlock.

(9) Error flag (XF)

- (a) If a write error occurs, Error flag (XF) will be set to on.
- (b) To clear the error code, set Error clear request (YF) to on.

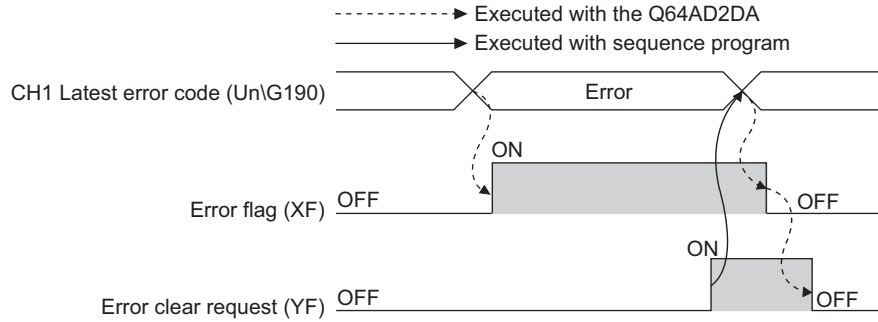

At the moment Error clear request (YF) turned on, Error flag (XF) is turned off and an error code is cleared.

Figure 5.8 Timing diagram of Error flag (XF)

5.2.2 Output signals

(1) CH1 Logging hold request (Y1)

For information on the output signals for CH2 or later channels, refer to Section 5.1.

- (a) If the level trigger condition setting using CH1 Level trigger condition setting (Un\G35) is "Disable" (0), a logging hold will be performed at the time of setting CH1 Logging hold request (Y1) to on.
- (b) If the level trigger condition setting using CH1 Level trigger condition setting (Un\G35) is valid (1 to 3), set CH1 Logging hold request (Y1) to on. When CH1 Logging hold request (Y1) is set to on, the logging status moves to trigger condition waiting status. If the setting condition of the level trigger is satisfied, a logging hold will be performed.
- (c) If CH1 Logging hold request (Y1) is set to off during a logging hold, the hold will be canceled and the logging data will be resumed.
- (d) For the logging facility, refer to Section 4.2.7.
- (e) For information on timings of when CH1 Logging hold request (Y1) is set to on or off, refer to the section describing CH1 Logging hold flag (X1). (Refer to Section 5.2.1 (2).)

(2) CH5 Output enable/disable flag (Y5)

For information on the output signals for CH6, refer to Section 5.1.

- (a) Specify whether to output the D/A converted value or output the offset value for each channel.
 - ON: D/A converted value
 - OFF: Offset value
- (b) The D/A conversion speed does not change regardless of whether CH5 Output enable/disable flag (Y5) is set to on or off. (Refer to Section 4.3.1 and Section 4.4.1.)

(3) Operating condition setting request (Y9)

- (a) Set this signal to on when making any of the following buffer memory valid.
- CH1 A/D conversion enable/disable setting (Un\G0)
 - CH5 D/A conversion enable/disable setting (Un\G800)
 - CH1 Averaging process method setting (Un\G1)
 - CH1 Averaging process (time / number of times) setting (Un\G2)
 - CH1 A/D conversion scaling enable/disable setting (Un\G10)
 - CH1 A/D conversion scaling lower limit value (Un\G11)
 - CH1 A/D conversion scaling upper limit value (Un\G12)
 - CH5 D/A conversion scaling enable/disable setting (Un\G810)
 - CH5 D/A conversion scaling lower limit value (Un\G811)
 - CH5 D/A conversion scaling upper limit value (Un\G812)
 - CH1 Input signal error detection setting (Un\G20)
 - CH1 Input signal error detection setting value (Un\G21)
 - CH1 Logging enable/disable setting (Un\G30)
 - CH1 Logging cycle setting value (Un\G31)
 - CH1 Logging cycle unit setting (Un\G32)
 - CH1 Logging data setting (Un\G33)
 - CH1 Logging points after trigger (Un\G34)
 - CH1 Level trigger condition setting (Un\G35)
 - CH1 Trigger data (Un\G36)
 - CH1 Trigger setting value (Un\G37)
- (b) For information on the timing of when Operating condition setting request (Y9) is set to on or off, refer to the section describing Operating condition setting completion flag (X9). (Refer to Section 5.2.1 (6).)

(4) Maximum and minimum values reset request (YD)

- (a) Set this signal to on when making any of the following buffer memory be cleared.
- CH1 Maximum digital output value (Un\G104)
 - CH1 Minimum digital output value (Un\G106)
 - CH1 Maximum scaling value (Un\G108)
 - CH1 Minimum scaling value (Un\G110)
- (b) For information on the timing of when Maximum and minimum values reset request (YD) is set to on or off, refer to the section describing Maximum and minimum values reset completion flag (XD). (Refer to Section 5.2.1 (7).)

(5) Error clear request (YF)

- (a) To clear a write error and input signal error, set Error clear request (YF) to on.
- (b) For information on the timing of when Error clear request (YF) is set to on or off, refer to the following:
- Input signal error detection signal (X7) (Refer to Section 5.2.1 (4).)
 - Error flag (XF) (Refer to Section 5.2.1 (9).)

CHAPTER6 BUFFER MEMORY

6.1 Buffer Memory Assignment

This section explains the buffer memory assignments of the Q64AD2DA.

Device numbers (X/Y) and buffer memory address shown in the Section 6.2 and later sections are for CH1 (the device number and buffer memory address used only for the D/A conversion are CH5.).

For the device numbers and buffer memory address used for other channels, refer to Section 5.1 and Section 6.1.

POINT

In the buffer memory, do not write data to the "system area" or area where data writing data from sequence programs is disabled.

Doing so may cause malfunction.

(1) A/D conversion area (Un\G0 to Un\G799)

Table 6.1 A/D conversion area (Un\G0 to Un\G799)

Item	Address (decimal)				Data type ¹	Description	Default	Read/write ²
	CH1	CH2	CH3	CH4				
A/D conversion area	0	200	400	600	Pr	A/D conversion enable/disable setting	1	R/W ³
	1	201	401	601		Averaging process method setting	0	R/W ³
	2	202	402	602		Averaging process (time / number of times) setting	4	R/W ³
	3 to 9	203 to 209	403 to 409	603 to 609	-	System area	-	-
	10	210	410	610	Pr	A/D conversion scaling enable/disable setting	1	R/W ³
	11	211	411	611		A/D conversion scaling lower limit value	0	R/W ³
	12	212	412	612		A/D conversion scaling upper limit value	0	R/W ³
	13	213	413	613		Shifting amount to conversion value	0	R/W ³
	14 to 19	214 to 219	414 to 419	614 to 619	-	System area	-	-
	20	220	420	620	Pr	Input signal error detection setting	0	R/W ³
	21	221	421	621		Input signal error detection setting value	0	R/W ³
	22 to 29	222 to 229	422 to 429	622 to 629	-	System area	-	-
	30	230	430	630	Pr	Logging enable/disable setting	1	R/W ³
	31	231	431	631		Logging cycle setting value	3000	R/W ³
	32	232	432	632		Logging cycle unit setting	0	R/W ³
	33	233	433	633		Logging data setting	1	R/W ³
	34	234	434	634		Logging points after trigger	5000	R/W ³
	35	235	435	635		Level trigger condition setting	0	R/W ³
	36	236	436	636		Trigger data	CH1: 102 CH2: 302 CH3: 502 CH4: 702	R/W ³
37	237	437	637	Trigger setting value		0	R/W ³	

6 BUFFER MEMORY

Table 6.1 A/D conversion area (Un\G0 to Un\G799)

Item	Address (decimal)				Data type ^{*1}	Description	Default	Read/write ^{*2}	
	CH1	CH2	CH3	CH4					
A/D conversion area	38	238	438	638	-	System area	-	-	
	to	to	to	to					
	99	299	499	699					
	100	300	500	700	Md	Digital output value	0	R	
	101	301	501	701	-	System area	-	-	
	102	302	502	702	Md	Scaling value	0	R	
	103	303	503	703	-	System area	-	-	
	104	304	504	704	Md	Maximum digital output value	0	R	
	105	305	505	705	-	System area	-	-	
	106	306	506	706	Md	Minimum digital output value	0	R	
	107	307	507	707	-	System area	-	-	
	108	308	508	708	Md	Maximum scaling value	0	R	
	109	309	509	709	-	System area	-	-	
	110	310	510	710	Md	Minimum scaling value	0	R	
	111	311	511	711	-	System area	-	-	
	112	312	512	712	Md	Setting range	0	R	
	113	313	513	713		A/D conversion completed flag	0	R	
	114	314	514	714		Input signal error detection flag	0	R	
	115	315	515	715	-	System area	-	-	
	to	to	to	to					
	119	319	519	719					
	120	320	520	720	Md	Oldest pointer	0	R	
	121	321	521	721		Latest pointer	0	R	
	122	322	522	722		Logging data points	0	R	
	123	323	523	723		Trigger pointer	0	R	
	124	324	524	724	-	System area	-	-	
	to	to	to	to					
	189	389	589	789					
190	390	590	790	Md	Latest error code	0	R		
191	391	591	791		Error time	First two digits of the year	Last two digits of the year	0	R
192	392	592	792			Month	Day	0	R
193	393	593	793			Hour	Minute	0	R
194	394	594	794			Second	Day of the week	0	R
195	395	595	795		-	System area	-	-	
to	to	to	to						
199	399	599	799						

* 1 Pr indicates the setting data and Md indicates the monitoring data.

* 2 Indicates whether reading from and writing to a sequence program are enabled.

R: Read enabled

W: Write enabled

* 3 When writing data to the buffer memory, always use the interlock condition (buffer memory write condition) of the following I/O signals.

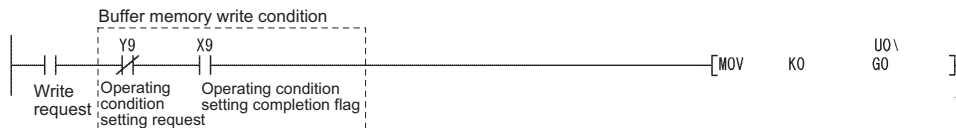

Figure 6.1 Setting example of interlock condition

(2) D/A conversion area (Un\G800 to Un\G1199)

Table 6.2 D/A conversion area (Un\G800 to Un\G1199)

Item	Address (decimal)		Data type ^{*1}	Description	Default	Read/write ^{*2}				
	CH5	CH6								
D/A conversion area	800	1000	Pr	D/A conversion enable/disable setting	1	R/W ^{*3}				
	801	1001	-	System area	-	-				
	802	1002	Pr	Digital input value	0	R/W ^{*3}				
	803	1003	-	System area	-	-				
	to	to								
	809	1009								
	810	1010	Pr	D/A conversion scaling enable/disable setting	1	R/W ^{*3}				
	811	1011		D/A conversion scaling lower limit value	0	R/W ^{*3}				
	812	1012		D/A conversion scaling upper limit value	0	R/W ^{*3}				
	813	1013		Shifting amount to input value	0	R/W ^{*3}				
	814	1014	-	System area	-	-				
	to	to								
	899	1099								
	900	1100	Md	Set value check code	0	R				
	901	1101	-	System area	-	-				
	902	1102	Md	Real conversion digital value	0	R				
	903	1103	-	System area	-	-				
	to	to								
	911	1111								
	912	1112	Md	Setting range	0	R				
	913	1113		HOLD/CLEAR function setting	0	R				
	914	1114	-	System area	-	-				
	to	to								
	989	1189								
	990	1190					Md	Latest error code	0	R
	991	1191						Error time	First two digits of the year	Last two digits of the year
	992	1192	Month	Day	0	R				
	993	1193	Hour	Minute	0	R				
994	1194	Second	Day of the week	0	R					
995	1195	-	System area	-	-					
to	to									
999	1199									

* 1 Pr indicates the setting data and Md indicates the monitoring data.

* 2 Indicates whether reading from and writing to a sequence program are enabled.

R: Read enabled

W: Write enabled

* 3 When writing data to the buffer memory, always use the interlock condition (buffer memory write condition) of the following I/O signals.

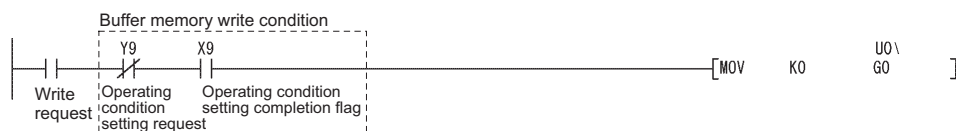

Figure 6.2 Setting example of interlock condition

(3) Common area (Un\G1200 to Un\G1799)

Table 6.3 Common area (Un\G1200 to Un\G1799)

Item	Address (decimal)	Data type ^{*1}	Description	Default	Read/write ^{*2}
Common area	1200 to 1599	-	System area	-	-
	1600	Pr	Level data 0	0	R/W ³
	1601		Level data 1	0	R/W ³
	1602		Level data 2	0	R/W ³
	1603		Level data 3	0	R/W ³
	1604		Level data 4	0	R/W ³
	1605		Level data 5	0	R/W ³
	1606		Level data 6	0	R/W ³
	1607		Level data 7	0	R/W ³
	1608		Level data 8	0	R/W ³
	1609		Level data 9	0	R/W ³
	1610 to 1699	-	System area	-	-
	1700	Md	CH1 Digital output value	0	R
	1701		CH2 Digital output value	0	R
	1702		CH3 Digital output value	0	R
	1703		CH4 Digital output value	0	R
	1704 to 1709	-	System area	-	-
	1710	Md	CH1 Scaling value	0	R
	1711		CH2 Scaling value	0	R
	1712		CH3 Scaling value	0	R
	1713		CH4 Scaling value	0	R
	1714 to 1719	-	System area	-	-
	1720	Md	CH1 Maximum digital output value	0	R
	1721		CH1 Minimum digital output value	0	R
	1722		CH2 Maximum digital output value	0	R
	1723		CH2 Minimum digital output value	0	R
	1724		CH3 Maximum digital output value	0	R
	1725		CH3 Minimum digital output value	0	R
	1726		CH4 Maximum digital output value	0	R
	1727		CH4 Minimum digital output value	0	R
	1728 to 1739	-	System area	-	-
	1740	Md	CH1 Maximum scaling value	0	R
	1741		CH1 Minimum scaling value	0	R
	1742		CH2 Maximum scaling value	0	R
	1743		CH2 Minimum scaling value	0	R
	1744		CH3 Maximum scaling value	0	R
	1745		CH3 Minimum scaling value	0	R
	1746		CH4 Maximum scaling value	0	R
	1747		CH4 Minimum scaling value	0	R
	1748 to 1763	-	System area	-	-

1 OVERVIEW

2 SYSTEM CONFIGURATION

3 SPECIFICATIONS

4 FUNCTION

5 I/O SIGNALS FOR THE CPU MODULE

6 BUFFER MEMORY

7 PREPARATORY PROCEDURES AND SETTING

8 UTILITY PACKAGE (GX Configurator-AD/GX Configurator-DA)

Table 6.3 Common area (Un\G1200 to Un\G1799)

Item	Address (decimal)	Data type ^{*1}	Description	Default	Read/write ^{*2}		
Common area	1764	Md	CH5 Set value check code	0	R		
	1765		CH6 Set value check code	0	R		
	1766 to 1773	-	System area	-	-		
	1774	Md	CH5 Real conversion digital value	0	R		
	1775		CH6 Real conversion digital value	0	R		
	1776 to 1789	-	System area	-	-		
	1790	Md	Latest error code		0	R	
	1791		Error time	First two digits of the year			Last two digits of the year
	1792			Month			Day
	1793			Hour			Minute
	1794			Second			Day of the week
	1795 to 1799	-	System area	-	-		

* 1 Pr indicates the setting data and Md indicates the monitoring data.

* 2 Indicates whether reading from and writing to a sequence program are enabled.

R: Read enabled

W: Write enabled

* 3 When writing data to the buffer memory, always use the interlock condition (buffer memory write condition) of the following I/O signals.

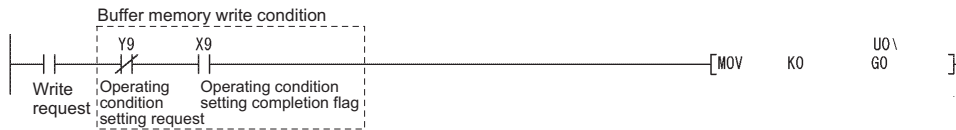

Figure 6.3 Setting example of interlock condition

(4) Error history (Un\G1800 to Un\G1964)

Table 6.4 Error history (Un\G1800 to Un\G1964)

Item	Address (decimal)	Data type ^{*1}	History number	Description	Default	Read/write ^{*2}		
Error history	1800	Md	Latest address of error history		0	R		
	1801 to 1809	-	System area		-	-		
	1810	Md	History 1	Error code		0	R	
	1811			Error time	First two digits of the year			Last two digits of the year
	1812				Month			Day
	1813				Hour			Minute
	1814				Second			Day of the week
	1815 to 1819	-	System area		-	-		
	1820	Md	History 2	Error code		0	R	
	1821			Error time	First two digits of the year			Last two digits of the year
	1822				Month			Day
	1823				Hour			Minute
	1824				Second			Day of the week
	1825 to 1829	-	System area		-	-		
	1830	Md	History 3	Error code		0	R	
	1831			Error time	First two digits of the year			Last two digits of the year
	1832				Month			Day
	1833				Hour			Minute
	1834				Second			Day of the week
	1835 to 1839	-	System area		-	-		
	1840	Md	History 4	Error code		0	R	
	1841			Error time	First two digits of the year			Last two digits of the year
	1842				Month			Day
	1843				Hour			Minute
	1844				Second			Day of the week
	1845 to 1849	-	System area		-	-		
	1850	Md	History 5	Error code		0	R	
	1851			Error time	First two digits of the year			Last two digits of the year
	1852				Month			Day
	1853				Hour			Minute
	1854				Second			Day of the week
	1855 to 1859	-	System area		-	-		

1 OVERVIEW

2 SYSTEM CONFIGURATION

3 SPECIFICATIONS

4 FUNCTION

5 I/O SIGNALS FOR THE CPU MODULE

6 BUFFER MEMORY

7 PREPARATORY PROCEDURES AND SETTING

8 UTILITY PACKAGE (GX Configurator-AD/GX Configurator-DA)

Table 6.4 Error history (Un\G1800 to Un\G1964)

Item	Address (decimal)	Data type ^{*1}	History number	Description			Default	Read/write ^{*2}	
Error history	1860	Md	History 6	Error code			0	R	
	1861			Error time	First two digits of the year	Last two digits of the year			
	1862				Month	Day			
	1863				Hour	Minute			
	1864				Second	Day of the week			
	1865 to 1869	-	System area			-	-		
	1870	Md	History 7	Error code			0	R	
	1871			Error time	First two digits of the year	Last two digits of the year			
	1872				Month	Day			
	1873				Hour	Minute			
	1874				Second	Day of the week			
	1875 to 1879	-	System area			-	-		
	1880	Md	History 8	Error code			0	R	
	1881			Error time	First two digits of the year	Last two digits of the year			
	1882				Month	Day			
	1883				Hour	Minute			
	1884				Second	Day of the week			
	1885 to 1889	-	System area			-	-		
	1890	Md	History 9	Error code			0	R	
	1891			Error time	First two digits of the year	Last two digits of the year			
	1892				Month	Day			
	1893				Hour	Minute			
	1894				Second	Day of the week			
	1895 to 1899	-	System area			-	-		
	1900	Md	History 10	Error code			0	R	
	1901			Error time	First two digits of the year	Last two digits of the year			
	1902				Month	Day			
	1903				Hour	Minute			
1904	Second				Day of the week				
1905 to 1909	-	System area			-	-			
1910	Md	History 11	Error code			0	R		
1911			Error time	First two digits of the year	Last two digits of the year				
1912				Month	Day				
1913				Hour	Minute				
1914				Second	Day of the week				

6 BUFFER MEMORY

Table 6.4 Error history (UnIG1800 to UnIG1964)

Item	Address (decimal)	Data type ^{*1}	History number	Description	Default	Read/write ^{*2}		
Error history	1915 to 1919	-	System area		-	-		
	1920	Md	History 12	Error code	0	R		
	1921			Error time			First two digits of the year	Last two digits of the year
	1922						Month	Day
	1923						Hour	Minute
	1924						Second	Day of the week
	1925 to 1929	-	System area		-	-		
	1930	Md	History 13	Error code	0	R		
	1931			Error time			First two digits of the year	Last two digits of the year
	1932						Month	Day
	1933						Hour	Minute
	1934						Second	Day of the week
	1935 to 1939	-	System area		-	-		
	1940	Md	History 14	Error code	0	R		
	1941			Error time			First two digits of the year	Last two digits of the year
	1942						Month	Day
	1943						Hour	Minute
	1944						Second	Day of the week
	1945 to 1949	-	System area		-	-		
	1950	Md	History 15	Error code	0	R		
	1951			Error time			First two digits of the year	Last two digits of the year
	1952						Month	Day
	1953						Hour	Minute
	1954						Second	Day of the week
1955 to 1959	-	System area		-	-			
1960	Md	History 16	Error code	0	R			
1961			Error time			First two digits of the year	Last two digits of the year	
1962						Month	Day	
1963						Hour	Minute	
1964						Second	Day of the week	

* 1 Pr indicates the setting data and Md indicates the monitoring data.

* 2 Indicates whether reading from and writing to a sequence program are enabled.

R: Read enabled

W: Write enabled

1

OVERVIEW

2

SYSTEM CONFIGURATION

3

SPECIFICATIONS

4

FUNCTION

5

I/O SIGNALS FOR THE CPU MODULE

6

BUFFER MEMORY

7

PREPARATORY PROCEDURES AND SETTING

8

UTILITY PACKAGE (GX Configurator-AD/GX Configurator-DA)

(5) Logging area (Un\G5000 to Un\G49999)

Table 6.5 Logging area (Un\G5000 to Un\G49999)

Item	Address (decimal)	Data type ^{*1}	Description	Default	Read/write ^{*2}
Logging area	5000 to 14999	Md	CH1 Logging data	0	R
	15000 to 24999		CH2 Logging data	0	R
	25000 to 34999		CH3 Logging data	0	R
	35000 to 44999		CH4 Logging data	0	R
	45000 to 49999	-	System area	-	-

* 1 Pr indicates the setting data and Md indicates the monitoring data.

* 2 Indicates whether reading from and writing to a sequence program are enabled.

R: Read enabled

W: Write enabled

6.2 CH1 A/D Conversion Enable/Disable Setting (Un\G0)

Whether to enable or disable A/D conversion is set.

For information on the buffer memory for CH2 or later channels, refer to Section 6.1 (1).

(1) Setting method

- (a) Set A/D conversion enable/disable setting by using the buffer memory.

Table 6.6 Setting range of CH1 A/D conversion enable/disable setting (Un\G0)

Setting value	Description
0	A/D conversion enabled
1	A/D conversion disabled

- (b) Set Operating condition setting request (Y9) to on to activate the setting. (Refer to Section 5.2.2 (3).)

(2) Default

A/D conversion is disabled (1) for all channels (CH1 to CH4) in default configuration.

6.3 CH1 Averaging Process Method Setting (Un\G1)

An averaging process method is set. (Refer to Section 4.2.1.)

For information on the buffer memory for CH2 or later, refer to Section 6.1 (1).

(1) Setting method

- (a) Set an averaging process method by using the buffer memory.

Table 6.7 Setting range of CH1 Averaging process method setting (Un\G1)

Setting value	Description	
0	Sampling processing	
1	Averaging processing*1	Time average
2		Count average
3		Moving average

* 1 If the averaging processing (1 to 3) is set, set an amount of time or number of times by using CH1 Averaging process (time / number of times) setting (Un\G2). (Refer to Section 6.4.)

- (b) Set Operating condition setting request (Y9) to on to activate the setting. (Refer to Section 5.2.2 (3).)

(2) Default

Sampling processing (0) is set for all channels (CH1 to CH4) in default configuration.

6.4 CH1 Averaging Process (Time/Number of Times) Setting (Un\G2)

If the averaging processing (1 to 3) is set, set an amount of time or number of times by using CH1 Averaging process method setting (Un\G1). (Refer to Section 4.2.1.)
For information on the buffer memory for CH2 or later, refer to Section 6.1 (1).

(1) Setting method

- (a) Set the range as listed below by using the buffer memory.

Table 6.8 Settable range

Processing method	Setting range
Time average	2 to 10000(ms) ^{*1}
Count average	4 to 20000 (times)
Moving average	2 to 60 (times)

* 1 To determine the time average, set the value meeting the following condition.

- Setting time ≥ 4 (times) $\times 0.5$ (ms) \times Number of channels to be used (Total number of A/D conversions or D/A conversion)

If the value that does not meet the above condition is set, an error (error code: □201) will occur and zero (0) will be stored into the digital output values.

- (b) Set Operating condition setting request (Y9) to on to activate the setting. (Refer to Section 5.2.2 (3).)

(2) Default

The value 4 is set for all channels (CH1 to CH4) in default configuration. If necessary, set the different value.

6.5 CH1 A/D Conversion Scaling Enable/Disable Setting (Un\G10)

Whether to enable or disable a scaling conversion of digital output values is set. (Refer to Section 4.2.3.)

For information on the buffer memory for CH2 or later, refer to Section 6.1 (1).

(1) Setting method

- (a) Set whether to enable or disable the A/D conversion scaling by using the buffer memory.

Table 6.9 CH1 A/D conversion scaling enable/disable setting (Un\G10)

Setting value	Description
0	A/D conversion scaling enabled
1	A/D conversion scaling disabled

- (b) Set Operating condition setting request (Y9) to on to activate the setting. (Refer to Section 5.2.2 (3).)

(2) Default

The A/D conversion scaling is disabled (1) for all the channels (CH1 to CH4) in default configuration.

6.6 CH1 A/D Conversion Scaling Lower Limit Value (Un\G11) and CH1 A/D Conversion Scaling Upper Limit Value (Un\G12)

A scaling range of converted digital output values is set. (Refer to Section 4.2.3.)
For information on the buffer memory for CH2 or later, refer to Section 6.1 (1).

(1) Setting method

- (a) Set an A/D scaling conversion range by using the buffer memory.
 - Settable range: -32000 to 32000
- (b) Set Operating condition setting request (Y9) to on to activate the setting. (Refer to Section 5.2.2 (3).)

(2) Default

The value 0 is set for all channels (CH1 to CH4) in default configuration.
When using a scaling function (A/D conversion), change the setting value.

☒ POINT

- (1) Setting a value outside the setting range described in (1)(a) in this section or a value that does not meet the inequality "Upper limit > Lower limit" will cause an error. (Refer to Section 11.1.)
- (2) When using a scaling function (A/D conversion), check that the A/D conversion scaling using CH1 A/D conversion scaling enable/disable setting (Un\G10) is made valid (0).

If the A/D conversion scaling is set to be invalid (1), scaling upper and lower limit values will be ignored.

- (3) If the analog input ranges are set as listed below, the digital output values corresponding to the scaling upper and lower limit values respectively will be the values listed in Table 6.10.

Table 6.10 Digital output values corresponding to the scaling upper or lower value

Analog input range	Setting mode	Digital output value	
		Corresponding to the scaling lower limit value	Corresponding to the scaling upper limit value
4 to 20mA (Extended mode)	Normal resolution mode	0	4000
1 to 5V (Extended mode)	High resolution mode		12000

6.7 CH1 Shifting Amount to Conversion Value (Un\G13)

A quantity to be shifted using the shifting function (A/D conversion) is set. (Refer to Section 4.2.4.)

For information on the buffer memory for CH2 or later, refer to Section 6.1 (1).

(1) Setting method

(a) Set a quantity to be shifted by using the buffer memory.

- Settable range: -32768 to 32767

(b) If a quantity to be shifted is set, the value set as a digital output value using CH1 Digital output value (Un\G100) will be added regardless of whether to set Operating condition setting request (Y9) to on or off.

(2) Default

The value 0 is set for all channels (CH1 to CH4) in default configuration.

6.8 CH1 Input Signal Error Detection Setting (Un\G20)

Whether to output the warning of the input signal error detection or stop is set. (Refer to Section 4.2.5.)

For information on the buffer memory for CH2 or later, refer to Section 6.1 (1).

(1) Setting method

(a) Set a method detecting warning by using the buffer memory.

Table 6.11 Setting range of CH1 Input signal error detection setting (Un\G20)

Setting value	Description	Description details
0	Disable	Disables the setting.
1	Upper and lower detection	Detects both upper and lower limits.
2	Lower detection	Detects a only lower limit.
3	Upper detection	Detects a only upper limit.
4	Disconnection detection	Used as a disconnection detection function*1 (Refer to Section 4.2.6 (3).)

* 1 The setting of detecting disconnections (4) is activated only when the analog input range of the target channel is set as follows:

- 4 to 20mA (Extended mode)
- 1 to 5V (Extended mode)

Setting to detect disconnections (4) for the channels have other settings causes an error (error code: □212).

(b) Set Operating condition setting request (Y9) to on to activate the setting. (Refer to Section 5.2.2 (3).)

(2) Default

The input signal error detection setting is set to be disabled (0) in default configuration.

6.9 CH1 Input Signal Error Detection Setting Value (Un\G21)

The value detecting an error of input analog values is set. (Refer to Section 4.2.5.)
For information on the buffer memory for CH2 or later, refer to Section 6.1 (1).

(1) Setting method

- (a) Set a value within the setting range by using the buffer memory.
 - Settable range: 0 to 250 (0 to 25.0%)
 - Set the value in 0.1% increments.

[Setting example] For setting the input signal error detection setting value to 15%
The value 150 is stored into CH1 Input signal error detection setting value (Un\G21).

- (b) Set Operating condition setting request (Y9) to on to activate the setting. (Refer to Section 5.2.2 (3).)

(2) Default

The input signal error detection setting value is set to 0 for all the channels (CH1 to CH4) in default configuration.

POINT

If the input signal error detection setting value using CH1 Input signal error detection setting (Un\G20) is set to detect disconnections (4), the value set in the data area of Input signal error detection setting value (Un\G21) will be ignored.

6.10 CH1 Logging Enable/Disable Setting (Un\G30)

Whether to enable or disable data logging is set. (Refer to Section 4.2.7 (3).)
For information on the buffer memory for CH2 or later, refer to Section 6.1 (1).

(1) Setting method

- (a) Set whether to enable or disable data logging by using the buffer memory.

Table 6.12 Setting range of CH1 Logging enable/disable setting (Un\G30)

Setting value	Description
0	Enabled
1	Disabled

- (b) Set Operating condition setting request (Y9) to on to activate the setting. (Refer to Section 5.2.2 (3).)

(2) Default

The setting of whether to enable or disable data logging is set to be disabled (1) for all channels (CH1 to CH4) in default configuration.

6.11 CH1 Logging Cycle Setting Value (Un\G31) and CH1 Logging Cycle Unit Setting (Un\G32)

A storing cycle of data for logging is set. (Refer to Section 4.2.7 (3).)

For information on the buffer memory for CH2 or later, refer to Section 6.1 (1).

(1) Setting method

- (a) Set a storing cycle of data by using the buffer memory.

Table 6.13 Setting range of logging cycle

CH1 Logging cycle unit setting (Un\G32)		CH1 Logging cycle setting value (Un\G31)
Setting value	Description	
0	μ s	500 to 32767
1	ms	1 to 32767
2	s	1 to 3600

- (b) Set Operating condition setting request (Y9) to on to activate the setting. (Refer to Section 5.2.2 (3).)

(2) Default

The values of the logging cycle setting and logging cycle unit setting are set for all channels (CH1 to CH4) as follows:

- CH1 Logging cycle setting value (Un\G31): 3000
- CH1 Logging cycle unit setting (Un\G32): 0

POINT

- (1) Set the data logging cycle to meet the following conditions.
 - Equal to the integral multiple of the updating cycle
 - Longer than the updating cycle
- (2) Unless the logging cycle is equal to the integral multiple of the updating cycle shown in Table 6.14, the logging cycle will be set to the maximum cycle equal to the integral multiple of the updating cycle within the setting range. Unless the setting logging cycle meets the updating cycle shown in Table 6.14, an error will occur and the data logging will not be performed. (Refer to Section 11.1.)

Table 6.14 Updating cycle of data to be logged

CH1 Averaging process method setting (Un\G1)	Updating cycle of data to be logged
Sampling processing (0)	Number of channels enabling conversion ^{*2} × 500 μ s
Time averaging (1)	Averaging process (time/number of times) setting ^{*3} ms
Count averaging (2)	Averaging process (time/number of times) setting ^{*3} × Number of channels enabling conversion ^{*2} × 500 μ s
Move averaging (3) ^{*1}	Number of channels enabling conversion ^{*2} × 500 μ s

* 1 Updating cycle of data to be logged with the moving average can be calculated with the same formula for the sampling processing so that data are updated at every sampling periods. (Refer to Section 4.2.1.)

* 2 Number of channels enabling A/D conversion and D/A conversion

* 3 Refer to the section describing CH1 Averaging process (time/number of times) setting (Un\G2).

(Refer to Section 6.4.)

6.12 CH1 Logging Data Setting (Un\G33)

Data to be logged is set during the logging facility use. (Refer to Section 4.2.7 (3).)
 For information on the buffer memory for CH2 or later, refer to Section 6.1 (1).

(1) Setting method

(a) Set data to be logged by using the buffer memory.

Table 6.15 Setting range of CH1 Logging data setting (Un\G33)

Setting value	Description	Description details
0	Digital output value	Logs CH1 Digital output value (Un\G100).
1	Scaling value	Logs CH1 Scaling value (Un\G102).

(b) Set Operating condition setting request (Y9) to on to activate the setting. (Refer to Section 5.2.2 (3).)

(2) Default

Scaling values (1) are set for all channels (CH1 to CH4) in default configuration.

6.13 CH1 Logging Points After Trigger (Un\G34)

The amount of data to be logged after the occurrence of a hold trigger is set during the logging facility use. (Refer to Section 4.2.7 (3).)

For information on the buffer memory for CH2 or later, refer to Section 6.1 (1).

(1) Setting method

(a) Set an amount of data to be logged by using the buffer memory.

- Settable range: 0 to 9999

(b) Set Operating condition setting request (Y9) to on to activate the setting. (Refer to Section 5.2.2 (3).)

(2) Default

The value 5000 is set for all channels (CH1 to CH4) in default configuration.

6.14 CH1 Level Trigger Condition Setting (Un\G35)

Conditions for using level triggers is set during the logging facility use. (Refer to Section 4.2.7 (3).)

For information on the buffer memory for CH2 or later, refer to Section 6.1 (1).

(1) Setting method

(a) Set a condition for using a level trigger by using the buffer memory.

Table 6.16 Setting range of CH1 Level trigger condition setting (Un\G35)

Setting value	Description	Timing of occurrence of level trigger
0	Disable	A hold trigger occurs only when CH1 Logging hold request (Y1) is set to on.
1	Above	<p>CH1 Trigger data (Un\G36) > CH1 Trigger setting value (Un\G37)</p> <p>When the amount of trigger data exceeds the trigger setting value, a level trigger occurs.</p>
2	Below	<p>CH1 Trigger data (Un\G36) < CH1 Trigger setting value (Un\G37)</p> <p>When the amount of trigger data falls below the trigger setting value, a level trigger occurs.</p>
3	Pass through	<p>If either of the following (1) or (2) is satisfied, a level trigger will occur.</p> <p>(1) If the condition "Current value of CH1 Trigger data (Un\G36) > CH1 Trigger setting value (Un\G37)" is satisfied under the condition "Previous value of CH1 Trigger data (Un\G36) ≤ CH1 Trigger setting value (Un\G37)"</p> <p>(2) If the condition "Current value of CH1 Trigger data (Un\G36) < CH1 Trigger setting value (Un\G37)" under the condition "Previous value of CH1 Trigger data (Un\G36) ≥ CH1 Trigger setting value (Un\G37)"</p> <p>When the amount of trigger data reaches to the trigger setting value, a level trigger occurs.</p>

(b) Set Operating condition setting request (Y9) to on to activate the setting. (Refer to Section 5.2.2 (3).)

(2) Default

The level trigger condition setting is set to be made invalid (0) for all the channels (CH1 to CH4) in default configuration.

☒ POINT

- (1) When using the level trigger, set the level trigger condition using CH1 Level trigger condition setting (Un\G35) to meet the following variations.
 - Above (1)
 - Below (2)
 - Pass through (3)
- (2) If CH1 Level trigger condition setting (Un\G35) is set to 0 (be disabled), the following processing will be performed.
 - The CH1 Trigger data (Un\G36) and CH1 Trigger setting value (Un\G37) settings will not be reflected.
 - Setting CH1 Logging hold request (Y1) to on will hold the data logging.

6.15 CH1 Trigger Data (Un\G36)

An address of buffer memory monitoring a level trigger for the occurrence is set during the logging facility use. (Refer to Section 4.2.7 (3).)

For information on the buffer memory for CH2 or later, refer to Section 6.1 (1).

(1) Setting method

- (a) Set an address of buffer memory storing data to be monitored by using the buffer memory.
 - Settable range: 0 to 1999
- (b) Set Operating condition setting request (Y9) to on to activate the setting. (Refer to Section 5.2.2 (3).)

(2) Default

Table 6.17 Default of CH1 Trigger data (Un\G36)

Channel	Description	Corresponding buffer memory
CH1	102	Scaling value
CH2	302	
CH3	502	
CH4	702	

POINT

Set adequate monitoring data such as digital output values, scaling values, and level data for trigger data. The other data settings do not guarantee the normal operation of the Q64AD2DA.

- [Example]
- Setting area (Pr)
 - System area

6.16 CH1 Trigger Setting Value (Un\G37)

A value that makes level triggers work is set during the logging facility use. (Refer to Section 4.2.7 (3).)

For information on the buffer memory for CH2 or later, refer to Section 6.1 (1).

(1) Setting method

- (a) Set a value that makes level triggers work by using the buffer memory.
 - Settable range: -32768 to 32767
- (b) Set Operating condition setting request (Y9) to on to activate the setting. (Refer to Section 5.2.2 (3).)

(2) Default

The value 0 is set for all the channels (CH1 to CH4) in default configuration.

6.17 CH1 Digital Output Value (Un\G100, Un\G1700)

The A/D converted digital output value is set to store.

For information on the buffer memory for CH2 or later, refer to Section 6.1 (1) and Section 6.1 (3).

(1) Stored data

(a) Storage form

Digital values are stored into the buffer memory in 16-bit signed binary form.

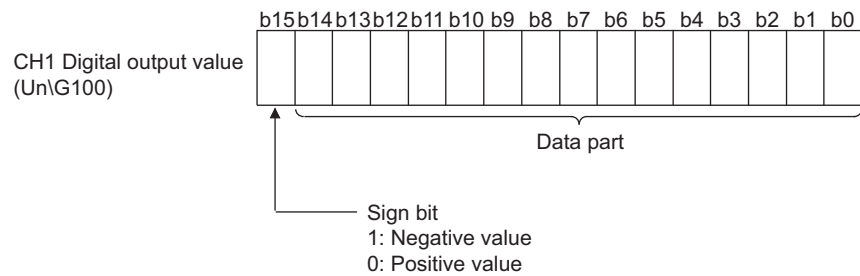

Figure 6.4 Storage data of CH1 Digital output value (Un\G100)

(b) Updating cycle (Refer to Section 4.2.1.)

- Averaging processing executed . . . Averaging processing cycle set
- Averaging processing unexecuted . . . Sampling processing time (number of channels to be used × 500 μs)

POINT

When reading the digital output values, use A/D conversion completed flag (XE) or CH1 A/D conversion completed flag (Un\G113) as an interlock.

6.18 CH1 Scaling Value (Un\G102, Un\G1710)

Scaled (for A/D conversion) and shifted (for A/D conversion) values (scaling value) using CH1 Digital output value (Un\G100) are stored.

For information on the buffer memory for CH2 or later, refer to Section 6.1 (1) and Section 6.1 (3).

(1) Stored data

(a) Storage form

Digital values are stored into the buffer memory in 16-bit signed binary form.

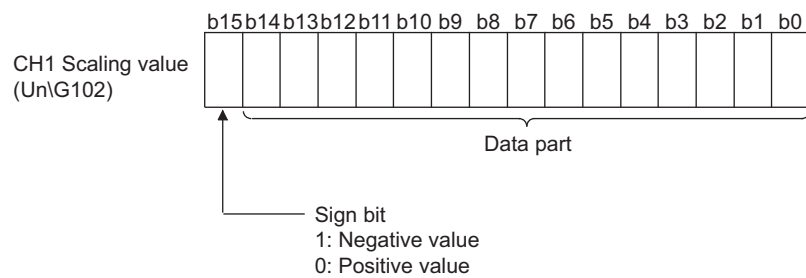

Figure 6.5 Storage data of CH1 Scaling value (Un\G102)

(b) Updating cycle (Refer to Section 4.2.1.)

The updating cycle is the time for sampling processing (number of channels to be used \times 500 μ s).

POINT

If the scaled and shifted values exceed the range from -32768 to 32767, the upper limit value will be 32767 and the lower limit value will be -32768.

6.19 CH1 Maximum Digital Output Value (Un\G104, Un\G1720) and CH1 Minimum Digital Output Value (Un\G106, Un\G1721)

The maximum and minimum digital output values converted are stored.
For information on the buffer memory for CH2 or later, refer to Section 6.1 (1) and Section 6.1 (3).

(1) Stored data

(a) Storage form

Digital values are stored into the buffer memory in 16-bit signed binary form.

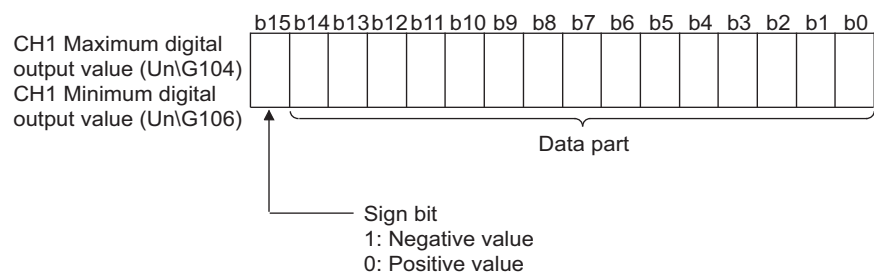

Figure 6.6 Storage data of CH1 Maximum digital output value (Un\G104) and CH1 Minimum digital output value (Un\G106)

(b) Updating cycle

The updating cycle is the time for sampling processing (number of channels to be used \times 500 μ s).

(2) How to reset storage data

To reset the storage data of all channels (CH1 to CH4), perform any of the following operations.

- Set Operating condition setting request (Y9) to on to change the setting.
- Set Maximum and minimum values reset request (YD) to on.

If the storage data is reset, the maximum and minimum values measured after the reset will be stored for all the channels (CH1 to CH4).

6.20 CH1 Maximum Scaling Value (Un\G108, Un\G1740) and CH1 Minimum Scaling Value (Un\G110, Un\G1741)

Maximum and minimum scaling values converted are stored.

For information on the buffer memory for CH2 or later, refer to Section 6.1 (1) and Section 6.1 (3).

(1) Stored data

(a) Storage form

Digital values are stored into the buffer memory in 16-bit signed binary form.

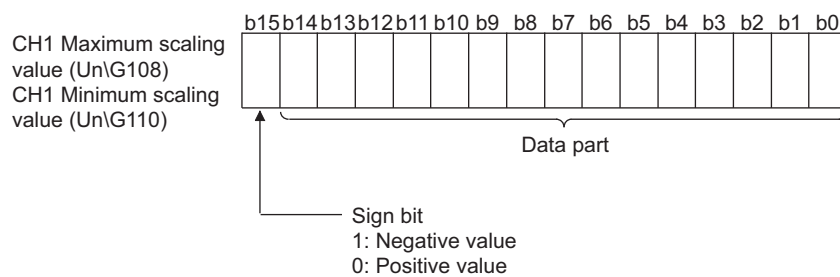

Figure 6.7 Storage data of CH1 Maximum scaling value (Un\G108) and CH1 Minimum scaling value (Un\G110)

(b) Updating cycle

The updating cycle is the time for sampling processing (number of channels to be used \times 500 μ s).

(2) How to reset storage data

To reset the storage data of all channels (CH1 to CH4), perform any of the following operations.

- Set Operating condition setting request (Y9) to on to change the setting.
- Set Maximum and minimum values reset request (YD) to on.

If the storage data is reset, the maximum and minimum values measured after the reset will be stored for all the channels (CH1 to CH4).

6.21 CH1 Setting Range (Un\G112)

Analog input range settings (in "Switch 1" of Switch setting for I/O and intelligent function module dialog box) for each analog input channel can be checked.

For information on the buffer memory for CH2 or later, refer to Section 6.1 (1).

(1) Stored data

Table 6.18 Stored data of CH1 Setting range (Un\G112)

Setting value	Analog input range
0H	4 to 20mA
1H	0 to 20mA
2H	1 to 5V
3H	0 to 5V
4H	-10 to 10V
5H	0 to 10V
AH	4 to 20mA (Extended mode)
BH	1 to 5V (Extended mode)

POINT

The setting range cannot be changed by using CH1 Setting range (Un\G112). Change the setting range in the Switch setting for I/O and intelligent function module dialog box. (Refer to Section 7.5.2.)

6.22 CH1 A/D Conversion Completed Flag (Un\G113)

An A/D conversion status can be checked.

For information on the buffer memory for CH2 or later, refer to Section 6.1 (1).

(1) Stored data

- (a) If an A/D conversion is completed for the channel enabling A/D conversion for a first time, the first data informing the completed A/D conversion (1) will be stored into the buffer memory.

Table 6.19 Storage data of CH1 A/D conversion completed flag (Un\G113)

Setting value	A/D conversion status
0	A/D conversion unused or in first A/D conversion
1	First A/D conversion completed

- (b) Immediately after A/D conversion is completed for all the channels enabling the conversion, A/D conversion completed flag (XE) is set to on. (Refer to Section 6.2.)

(2) How to clear storage data

To clear the storage data of all channels (CH1 to CH4), set Operating condition setting request (Y9) to on.

POINT

When reading the digital output values, use A/D conversion completed flag (XE) or CH1 A/D conversion completed flag (Un\G113) as an interlock.

6.23 CH1 Input Signal Error Detection Flag (Un\G114)

An input signal status can be checked.

For information on the buffer memory for CH2 or later, refer to Section 6.1 (1).

(1) Stored data

Table 6.20 Storage data of CH1 Input signal error detection flag (Un\G114)

Setting value	Input signal status
0	Normal
1	Input signal error

- (a) An input signal error (1) will occur for CH1 Input signal error detection flag (Un\G114) in the following case.
- The Q64AD2DA detects an analog input value being out of the range set with CH1 Input signal error detection setting value (Un\G21).
- (b) If an error is detected in even one of the following settings, Input signal error detection signal (X7) will be set to on.
- 1) Set to enable (set to one of 1 to 4) the input signal error detection setting by using CH1 Input signal error detection setting (Un\G20).
 - 2) Set to enable A/D conversion (set to 0) by using CH1 A/D conversion enable/disable setting (Un\G0).

(2) How to clear storage data

To clear the storage data of all the channels (CH1 to CH4), perform the following settings.

- 1) Set the analog input value within the setting range.
- 2) Set Error clear request (YF) or Operating condition setting request (Y9) to on.

6.24 CH1 Oldest Pointer (Un\G120)

In the logging data storage area, an address of buffer memory storing the oldest data can be checked. (Refer to Section 4.2.7 (4).)

For information on the buffer memory for CH2 or later, refer to Section 6.1 (1).

(1) Stored data

The difference between the numeric value of the address storing the oldest data and the numeric value of the start address in the logging data storage area is stored.

[Storage example] When the value to be stored into CH2 Oldest pointer (Un\G320) is 8551:

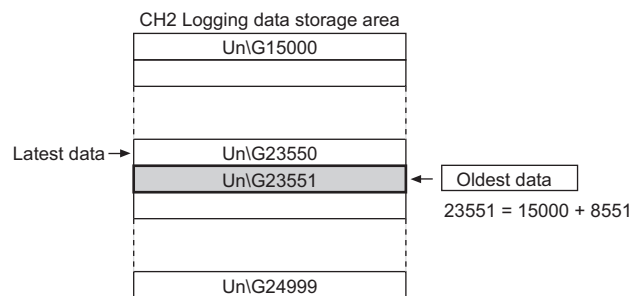

Figure 6.8 Status of CH2 Logging data storage area (Un\G15000 to Un\G24999)

POINT

- (1) The value of the oldest pointer is fixed to 0 because the oldest data is stored into the beginning of the logging data storage area while logging data from the start area to 10000th area.
- (2) After the 10000th area, CH1 Oldest pointer (Un\G120) moves to the next area whenever new data are stored (The numeric value 1 increases every time.)

6.25 CH1 Latest Pointer (Un\G121)

In the logging data storage area, an address of buffer memory storing the latest data can be checked. (Refer to Section 4.2.7 (4).)

For information on the buffer memory for CH2 or later, refer to Section 6.1 (1).

(1) Stored data

The difference between the numeric value of the address storing the latest data and the numeric value of the start address in the logging data storage area is stored.

[Storage example] When the value to be stored into CH2 Latest pointer (Un\G121) is 8550:

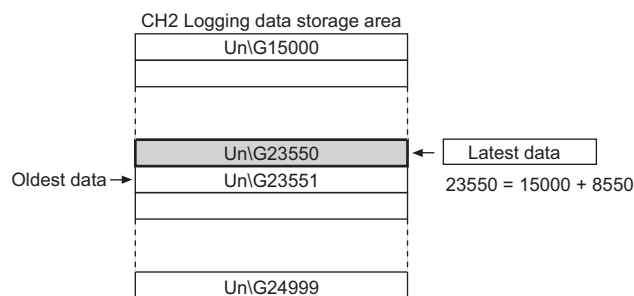

Figure 6.9 Status of CH2 Logging data storage area (Un\G15000 to Un\G24999)

POINT

CH1 Latest pointer (Un\G121) moves to the next area whenever data logging starts and new data are stored (The numeric value 1 increases every time.)

6.26 CH1 Logging Data Points (Un\G122)

An amount of data stored in the logging data storage area can be checked during the logging facility use. (Refer to Section 4.2.7 (4).)

For information on the buffer memory for CH2 or later, refer to Section 6.1 (1).

(1) Stored data

- (a) After data logging starts, the value of the buffer memory increases by 1 whenever new data are stored into CH1 Logging data storage area (Un\G5000 to Un\G14999).
- (b) CH1 Logging data storage area (Un\G5000 to Un\G14999) can store up to 10000 data.
If CH1 Logging data storage area (Un\G5000 to Un\G14999) becomes full, the data in the logging data storage area is written over from the start area. Consequently, the amount of logging data in CH1 Logging data points (Un\G122) is fixed to 10000.

6.27 CH1 Trigger Pointer (Un\G123)

In the logging data storage area, an address of area storing the data at the point of the hold trigger occurrence can be checked. (Refer to Section 4.2.7 (4).)

For information on the buffer memory for CH2 or later, refer to Section 6.1 (1).

(1) Stored data

The difference between the value of the address of area storing the data at the point of the hold trigger occurrence and the value of the start address in the logging data storage area is stored.

[Storage area] When the value to be stored into CH2 Trigger pointer (Un\G323) is 8550:

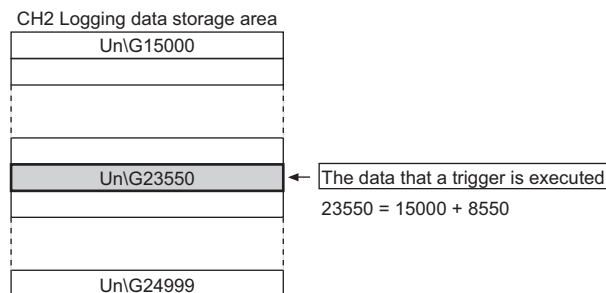

Figure 6.10 Status of CH2 Logging data storage area (Un\G15000 to Un\G24999)

POINT

If the hold trigger occurs (CH1 Logging hold flag (X1) is set to on.), the address of the area storing the latest data at the point will be stored.

6.28 CH1 Latest Error Code (Un\G190), CH1 Error Time (Un\G191 to Un\G194), Latest Error Code (Un\G1790), and Error Time (Un\G1791 to Un\G1794)

Latest error codes and error time detected by the Q64AD2DA can be checked. (Refer to Section 11.1.)

For information on the buffer memory for CH2 or later, refer to Section 6.1 (1), Section 6.1 (2), and Section 6.1 (3).

(1) Stored data

- (a) CH1 Latest error code (Un\G190) and Latest error code (Un\G1790)

Latest error codes are stored.

For the list of error codes, refer to Section 11.1.

- (b) CH1 Error time (Un\G191 to Un\G194) and Error time (Un\G1791 to Un\G1794)

Latest error time is stored in BCD code.

Table 6.21 Storage data of CH1 Error time (Un\G191 to Un\G194)

Buffer memory address	Description																
Un\G191	<p>Year</p>																
Un\G192	<p>Month Day</p>																
Un\G193	<p>Hour Minute</p>																
Un\G194	<p>Second Fixed to 0H</p> <table border="1" style="margin-left: 20px;"> <thead> <tr> <th colspan="2">Day of the week</th> </tr> </thead> <tbody> <tr><td>0</td><td>Sunday</td></tr> <tr><td>1</td><td>Monday</td></tr> <tr><td>2</td><td>Tuesday</td></tr> <tr><td>3</td><td>Wednesday</td></tr> <tr><td>4</td><td>Thursday</td></tr> <tr><td>5</td><td>Friday</td></tr> <tr><td>6</td><td>Saturday</td></tr> </tbody> </table>	Day of the week		0	Sunday	1	Monday	2	Tuesday	3	Wednesday	4	Thursday	5	Friday	6	Saturday
Day of the week																	
0	Sunday																
1	Monday																
2	Tuesday																
3	Wednesday																
4	Thursday																
5	Friday																
6	Saturday																

POINT

- (1) The data of error time are stored into CH1 Error time (Un\G191 to Un\G194) and Error time (Un\G1791 to Un\G1794) on the basis of the CPU module time information. If the error time is wrong, check the time setting of the CPU module.
- (2) When using network modules, the error time may not be stored as follows: When using the Q64AD2DA in the MELSECNET/H remote I/O network, the time information is transferred as shown below. Therefore, the sequence of power supply for the system and the error timing may result in storing wrong information at the point of error occurrence.
 - CPU module → MELSECNET/H master module → MELSECNET/H remote module → Q64AD2DA

[Example] The remote module is powered on firstly and the CPU module is powered on secondly. Consequently, an error occurs immediately after the remote module is powered on.

6.29 CH5 D/A Conversion Enable/Disable Setting (Un\G800)

Whether to enable or disable D/A conversion is set.

For information on the buffer memory for CH6, refer to Section 6.1 (2).

(1) Setting method

- (a) Set D/A conversion enable/disable setting by using the buffer memory.

Table 6.22 Setting range of CH5 D/A conversion enable/disable setting (Un\G800)

Setting value	Description
0	D/A conversion enabled
1	D/A conversion disabled

- (b) Set Operating condition setting request (Y9) to on to activate the setting. (Refer to Section 5.2.2 (3).)

(2) Default

D/A conversion is set to be disabled (1) for all the channels (CH5 and CH6) in default configuration.

POINT

Design the system so that the D/A conversion is enabled (0) by using CH5 D/A conversion enable/disable setting (Un\G800) after the external power (Refer to Section 7.3.) is supplied. Analog output may not be performed properly if the external power is not at the specified voltage.

6.30 CH5 Digital Input Value (Un\G802)

Digital input values are written from the CPU module as 16-bit signed binary code to perform D/A conversion.

For information on the buffer memory for CH6, refer to Section 6.1 (2).

(1) Setting method

Set digital input values to be D/A converted to the buffer memory.

The settable range depends on the output range setting or resolution setting. (Refer to the settable ranges in Table 6.23.)

Table 6.23 Settable range corresponding to the output ranges and processing of digital values exceeding settable range

Output range setting ^{*1}	Normal resolution mode ^{*2}		High resolution mode ^{*2}	
	Settable range (Real range)	Processing for the case of written digital input values exceeding settable range	Settable range (Real range)	Processing for the case of written digital input values exceeding settable range
0H: 4 to 20mA	-96 to 4095 (real range: 0 to 4000)	4096 or more: 4095 -97 or less: -96	-288 to 12287 (real range: 0 to 12000)	12288 or more: 12287 -289 or less: -288
1H: 0 to 20mA				
2H: 1 to 5V				
3H: 0 to 5V				
4H: -10 to 10V	-4096 to 4095 (real range: -4000 to 4000)	4096 or more: 4095 -4097 or less: -4096	-16384 to 16383 (real range: -16000 to 16000)	16384 or more: 16383 -16385 or less: -16384

* 1 Set in "Switch 2" of Switch setting for I/O and intelligent function module dialog box (Refer to Section 7.5.2.)

* 2 Set in "Switch 4" of Switch setting for I/O and intelligent function module dialog box (Refer to Section 7.5.2.)

(2) Default

The digital input value 0 is set for all the channels (CH5 and CH6) in default configuration.

To perform D/A conversion, change the setting value.

POINT

The digital input values for all the channels (CH5 and CH6) will be 0 in the following case.

- After the CPU module is powered on, Module ready (X0) is set to on.
- After the CPU module is reset, Module ready (X0) is set to on.

6.31 CH5 D/A Conversion Scaling Enable/Disable Setting (Un\G810)

Whether to enable or disable a scaling conversion of digital input values is set. (Refer to Section 4.3.4.)

For information on the buffer memory for CH6, refer to Section 6.1 (2).

(1) Setting method

- (a) Set whether to enable or disable the D/A conversion scaling by using the buffer memory.

Table 6.24 CH5 D/A conversion scaling enable/disable setting (Un\G810)

Setting value	Description
0	D/A conversion scaling enabled
1	D/A conversion scaling disabled

- (b) Set Operating condition setting request (Y9) to on to activate the setting. (Refer to Section 5.2.2 (3).)

(2) Default

The D/A conversion scaling is disabled (1) for all the channels (CH5 and CH6) in default configuration.

6.32 CH5 D/A Conversion Scaling Lower Limit Value (Un\G811) and CH5 D/A Conversion Scaling Upper Limit Value (Un\G812)

A scaling range of converted digital input values is set. (Refer to Section 4.3.4.)
For information on the buffer memory for CH6, refer to Section 6.1 (2).

(1) Setting method

- (a) Set an D/A scaling conversion range by using the buffer memory.
 - Settable range: -32000 to 32000
- (b) Set Operating condition setting request (Y9) to on to activate the setting. (Refer to Section 5.2.2 (3).)

(2) Default

The value 0 is set for all the channels (CH5 and CH6) in default configuration.
When using a scaling function (D/A conversion), change the setting value.

POINT

When using a scaling function (D/A conversion), check that the D/A conversion scaling using CH5 D/A conversion scaling enable/disable setting (Un\G810) is made valid (0).

If the D/A conversion scaling is set to be invalid (1), scaling upper and lower limit values will be ignored.

6.33 CH5 Shifting Amount to Input Value (Un\G813)

A quantity to be shifted using the shifting function (D/A conversion) is set. (Refer to Section 4.3.5.)
For information on the buffer memory for CH6, refer to Section 6.1 (2).

(1) Setting method

- (a) Set a quantity to be shifted by using the buffer memory.
 - Settable range: -32768 to 32767
- (b) If a quantity to be shifted is set, the value set as a digital output value using CH5 Digital input value (Un\G802) will be added regardless of whether to set Operating condition setting request (Y9) to on or off.

(2) Default

The value 0 is set for all the channels (CH5 and CH6) in default configuration.

6.34 CH5 Set Value Check Code (Un\G900, Un\G1764)

Whether digital values outside the settable range are set by using CH5 Digital input value (Un\G802) can be checked.

For information on the buffer memory for CH6, refer to Section 6.1 (2) and Section 6.1 (3).

(1) Stored data

- (a) When a digital input value outside the settable range (Refer to Section 6.30.) is set by using CH5 Digital input value (Un\G802), one of the check codes listed in Table 6.25 is stored.

Table 6.25 Check code list

Check code	Description
000FH	A digital input value exceeding the settable range is set.
00F0H	A digital input value that falls short of the settable range is set.
00FFH	A digital input value that either falls short or exceeds the settable range was set. For example, the 00FFH check code is stored if a digital input value exceeding the valid range is set, and then, without the check code being reset, a digital input value that falls short of the settable range is set.

- (b) When a digital input value outside the settable range is set, an error code (□003) is stored into CH5 Latest error code (Un\G990).

(2) How to clear storage data

- (a) To clear the storage data of all the channels (CH5 and CH6), perform the following settings.
 - 1) Rewrite the digital input value by using CH5 Digital input value (Un\G802) so that it is within the settable range.
 - 2) Set Error clear request (YF) to on.
- (b) Once a check code is stored, it will not be cleared until the above setting is performed even if the digital input value by using CH5 Digital input value (Un\G802) is within the settable range.

☒ POINT

When using the scaling function (D/A conversion), digital input values set in CH5 Digital input value (Un\G802) are checked. (Refer to Section 4.3.4.)

6.35 CH5 Real Conversion Digital Value (Un\G902, Un\G1774)

Digital values equivalent to output analog values can be checked.

For information on the buffer memory for CH6, refer to Section 6.1 (2) and Section 6.1 (3).

(1) Stored data

Shifted and scaled setting values of CH5 Digital input value (Un\G802) are stored into the buffer memory in 16-bit signed binary form.

6.36 CH5 Setting Range (Un\G912)

Analog output range settings (in "Switch 2" of the Switch setting for I/O and intelligent function module dialog box) for each analog output channel can be checked.

For information on the buffer memory for CH6, refer to Section 6.1 (2).

(1) Stored data

Table 6.26 Storage data of CH5 Setting range (Un\G912)

Setting value	Analog output range
0H	4 to 20mA
1H	0 to 20mA
2H	1 to 5V
3H	0 to 5V
4H	-10 to 10V

POINT

The setting range cannot be changed by using CH5 Setting range (Un\G912). Change the setting range in the Switch setting for I/O and intelligent function module dialog box. (Refer to Section 7.5.2.)

6.37 CH5 HOLD/CLEAR Function Setting (Un\G913)

Analog output HOLD/CLEAR function settings (in "Switch 3" of the Switch setting for I/O and intelligent function module dialog box) for each analog output channel can be checked.

For information on the buffer memory for CH6, refer to Section 6.1 (2).

(1) Stored data

Table 6.27 Storage data of CH5 HOLD/CLEAR function setting (Un\G913)

Setting value	Analog output range
0H	CLEAR
1H	HOLD

POINT

The analog output HOLD/CLEAR function setting cannot be changed by using CH5 HOLD/CLEAR function setting (Un\G913). Change the HOLD/CLEAR function setting in the Switch setting for I/O and intelligent function module dialog box. (Refer to Section 7.5.2.)

6.38 Level Data (Un\G1600 to Un\G1609)

Level data are used as monitoring data making level triggers work when using level triggers of logging facility. The level data monitor devices specified for CPU modules or the like, excluding the buffer memory area of the Q64AD2DA, to cause occurrence of triggers. (Refer to Section 6.15.)

Table 6.28 Buffer memory address where level data are stored

Level data	Buffer memory address
Level data 0	Un\G1600
Level data 1	Un\G1601
Level data 2	Un\G1602
Level data 3	Un\G1603
Level data 4	Un\G1604
Level data 5	Un\G1605
Level data 6	Un\G1606
Level data 7	Un\G1607
Level data 8	Un\G1608
Level data 9	Un\G1609

(1) Example of use

Write the adequate value of the buffer memory address storing level data to CH1 Trigger data (Un\G36).

[Example] How to use level data

To monitor the data register D100 in CPU modules and make the level trigger of the channel 1 work, configure a sequence program as shown below.

- (a) Write 1600 (level data 0) to CH1 Trigger data (Un\G36). (For the use of the level data 0)
- (b) Transfer the stored data of D100 to the level data 0 (Un\G1600) if necessary.



* 1 This program is configured, when the start I/O number is set to 0.

Figure 6.11 How to use level data

6.39 Latest Address of Error History (Un\G1800)

A buffer memory address storing the latest error history is shown.

(1) Stored data

Table 6.29 Storage data of Latest address of error history (Un\G1800)

Stored value	Latest error history
0	No errors
1810	Error history 1 (Un\G1810 to Un\G1814)
1820	Error history 2 (Un\G1820 to Un\G1824)
⋮	⋮
1960	Error history 16 (Un\G1960 to Un\G1964)

6.40 Error History (Un\G1810 to Un\G1964)

Up to 16 error logs that occurred in the Q64AD2DA are registered. (Refer to Section 11.1.)
An error history is registered to 10 words of buffer memory area as shown in Table 6.30.

Table 6.30 Error history (Un\G1810 to Un\G1964)

Storage area		Description
Error history 1	Un\G1810	Error code
	Un\G1811 to Un\G1814	Error time
	to	-
Error history 2	Un\G1820	Error code
	Un\G1821 to Un\G1824	Error time
	to	-
⋮	⋮	⋮
Error history 16	Un\G1960	Error code
	Un\G1961 to Un\G1964	Error time
	-	-

If a new error occurs, the error history will be stored into the area located after the area storing the latest error history and the latest address of error history will be updated.
If 16 or more errors occurred in the past, a new error will be written over the oldest error history area.

POINT

Unlike the latest error code, setting Error clear request (YF) or Operating condition setting request (Y9) to on does not clear the error history.

The error history remains without powering on or resetting CPU modules.

6.41 CH1 Logging Data Storage Area (Un\G5000 to Un\G14999)

Logged data can be checked by using the logging facility. (Refer to Section 4.2.7 (4).)
For information on the buffer memory for CH2 or later, refer to Section 6.1 (5).

- (a) Even if CH1 Logging data storage area (Un\G5000 to Un\G14999) becomes full, the data will be written over from the start area for logging data.
- (b) If CH1 Logging hold request (Y1) is set to off while CH1 Logging hold flag (X1) is set to on, data logging will restart.
However, the logged data will not be cleared.

POINT

Setting Operating condition setting request (Y9) to on clears the logging data of all the channels.

CHAPTER 7 PREPARATORY PROCEDURES AND SETTING

7.1 Handling Precautions

- (1) Do not drop or apply strong shock to the module case.
- (2) Do not remove the printed-circuit board of the module from the case. Doing so may cause failure.
- (3) Prevent foreign matter such as dust or wire chips from entering the module.
Such foreign matter can cause a fire, failure, or malfunction.
- (4) A protective film is attached to the top of the module to prevent foreign matter, such as wire chips, from entering the module during wiring. Do not remove the film during wiring.
Remove it for heat dissipation before system operation.
- (5) Tighten the screws such as module fixing screws within the following ranges.
Undertightening can cause short circuit, failure, or malfunction.

Table 7.1 Tightening torque

Screw	Tightening torque range
Module fixing screw (M3 screw) ^{*1}	0.36 to 0.48N·m
Terminal block terminal screw (M3 screw)	0.42 to 0.58N·m
Terminal block mounting screw (M3.5 screw)	0.66 to 0.89N·m
External power supply connector screw (M3 screw)	0.5 to 0.6N·m

* 1 The module can be easily fixed onto the base unit using the hook at the top of the module. However, it is recommended to secure the module with the module fixing screw when using the module in an environment of frequent vibrations.

- (6) To mount the module, while pressing the module mounting lever located in the lower part of the module, fully insert the module fixing projection(s) into the hole(s) in the base unit and press the module until it snaps into place.
Incorrect mounting may cause malfunction, failure or drop of the module.
- (7) Before handling the module, touch a grounded metal object to discharge the static electricity from the human body.
Failure to do so may cause the module to fail or malfunction.

7.2 Preparatory Procedures and Setting

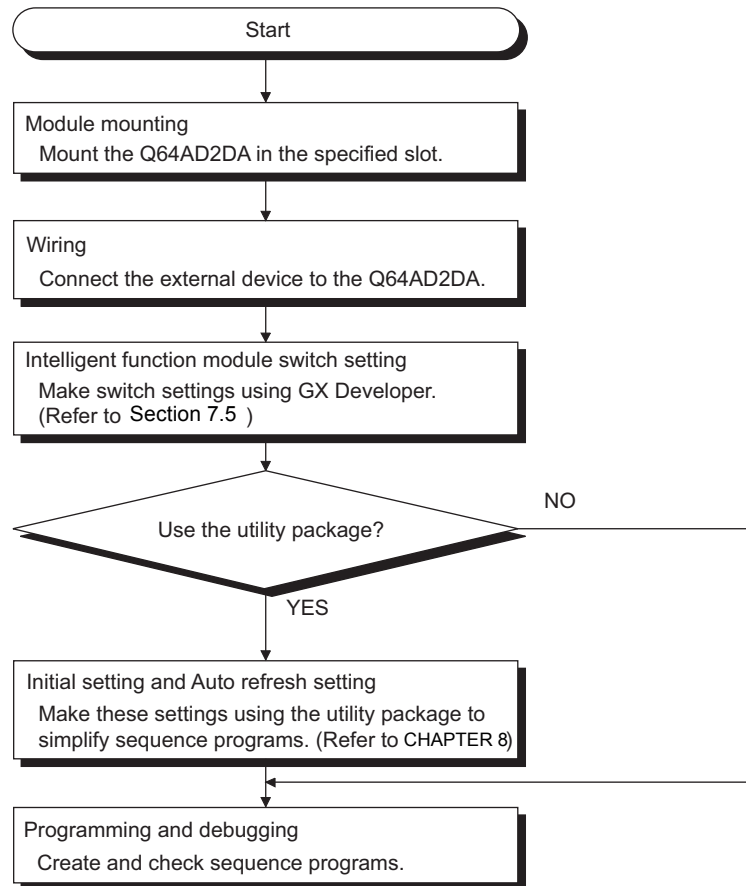

Figure 7.1 Preparatory procedures

7.3 Part Names

The following explains the part names of the Q64AD2DA.

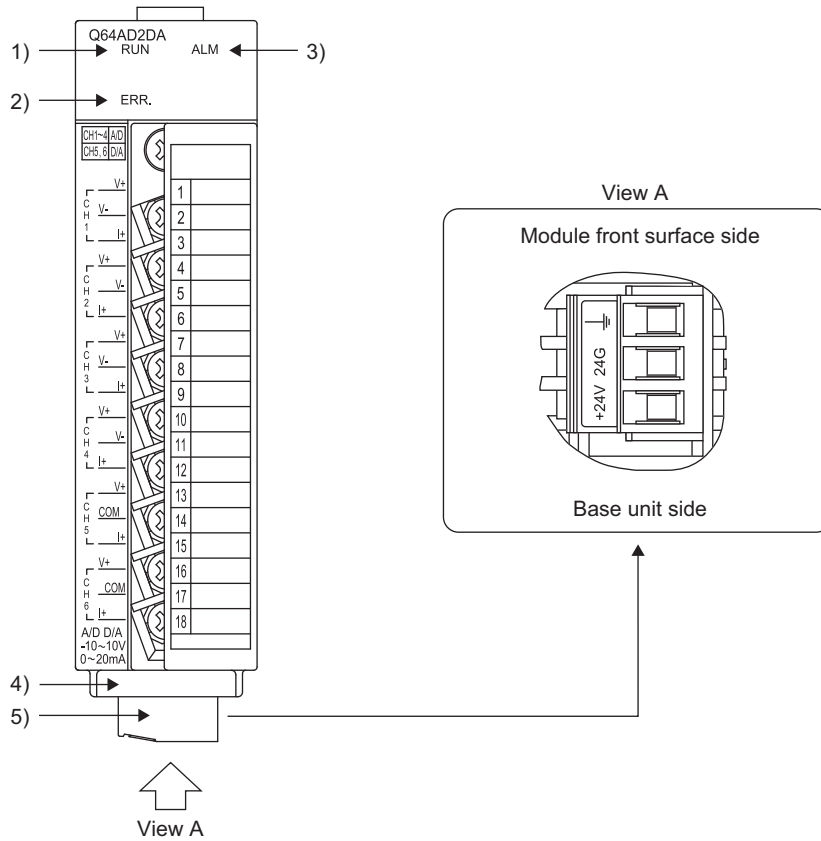

Figure 7.2 Module appearance

(1) Part names

The following table shows the part names.

Table 7.2 Part names

Number	Name	Description
1)	RUN LED	Indicates the operating status of the Q64AD2DA. On : Normal operation Off : 5V power supply is shut off, watchdog timer error occurred, or online module change is enabled.
2)	ERR. LED	Indicates the error and status of the Q64AD2DA. On : Error*1 Flashing : Switch setting error Other than 0H is set to the switch 5 of the intelligent function module. Off : Normal operation
3)	ALM LED	Indicates the warning status of the Q64AD2DA. Flashing : Input signal error Off : Normal operation
4)	Serial number plate	Indicates the serial number of the Q64AD2DA.
5)	External power supply connector	Terminal connector that connects 24VDC external power supply and FG terminal

* 1 For details, check the error code. (Refer to Section 11.1.)

(2) Signal names of terminal block

The following table shows the signal names of the terminal block.

Table 7.3 Signal names of terminal block

Terminal number	Conversion type	Channel	Signal name
1	A/D	CH1	V+
2			V-/I-
3			I+
4		CH2	V+
5			V-/I-
6			I+
7		CH3	V+
8			V-/I-
9			I+
10		CH4	V+
11			V-/I-
12			I+
13	D/A	CH5	V+
14			COM
15			I+
16		CH6	V+
17			COM
18			I+

7.4 Wiring

The following explains the wiring precautions and module wiring examples.

7.4.1 Wiring precautions

To achieve a reliable system and fully utilize the functionality of the Q64AD2DA, external wiring resistant to noise is required.

This section provides wiring precautions.

- (1) Use separate cables for the AC control circuit and the external input signals of the Q64AD2DA to avoid the influence of the AC side surges and inductions.**
- (2) Do not install external wiring cables together with the main circuit line, a high-voltage cable, and a load cable from other than the programmable controller.**
Failure to do so may cause the module more susceptible to noises, surges and inductions.
- (3) The shielded cable or the shield must be grounded with a single point ground.**
- (4) No solderless terminal with insulation sleeve can be used on the terminal block. It is recommended to cover the solderless terminals connecting electric cables with a mark tube or insulating tube.**

(5) The following actions are required for the module to comply with the EMC and Low Voltage Directives.

- (a) Always use a shielded twisted pair cable and ground it from the control panel through the AD75CK cable clamp (manufactured by Mitsubishi).

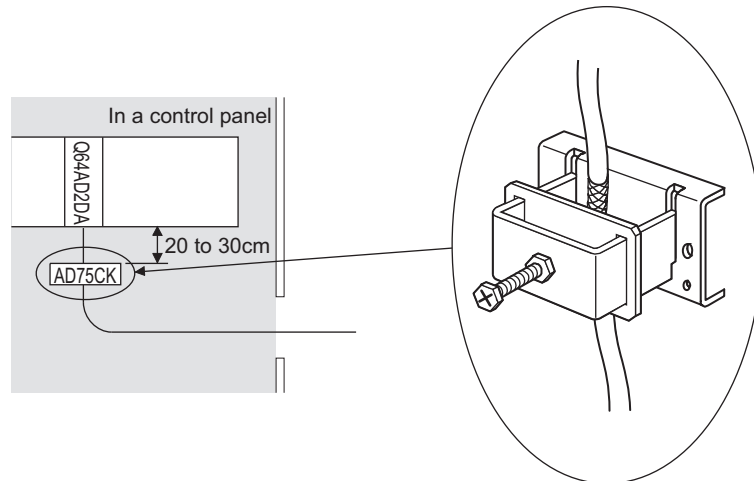

Figure 7.3 AD75CK cable clamp

For details on the AD75CK, refer to the following manual.

☞ AD75CK type Cable Clamping Instruction Manual

- (b) Install a ferrite core to an external power supply connection cable with keeping it 4cm (1.58 inches) away from the module.

Ferrite core: ZCAT3035-1330 (manufactured by TDK Corporation.)

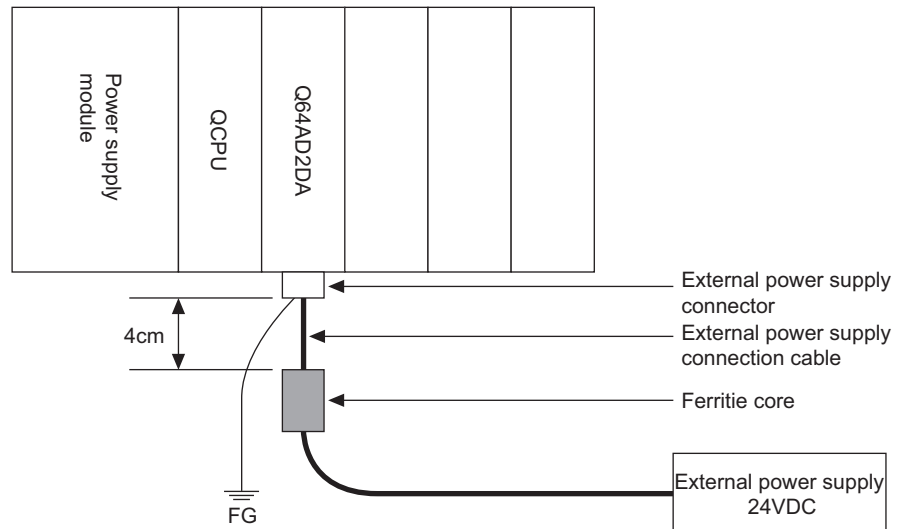

Figure 7.4 Installing a ferrite core to an external power supply connection cable

7.4.2 External wiring

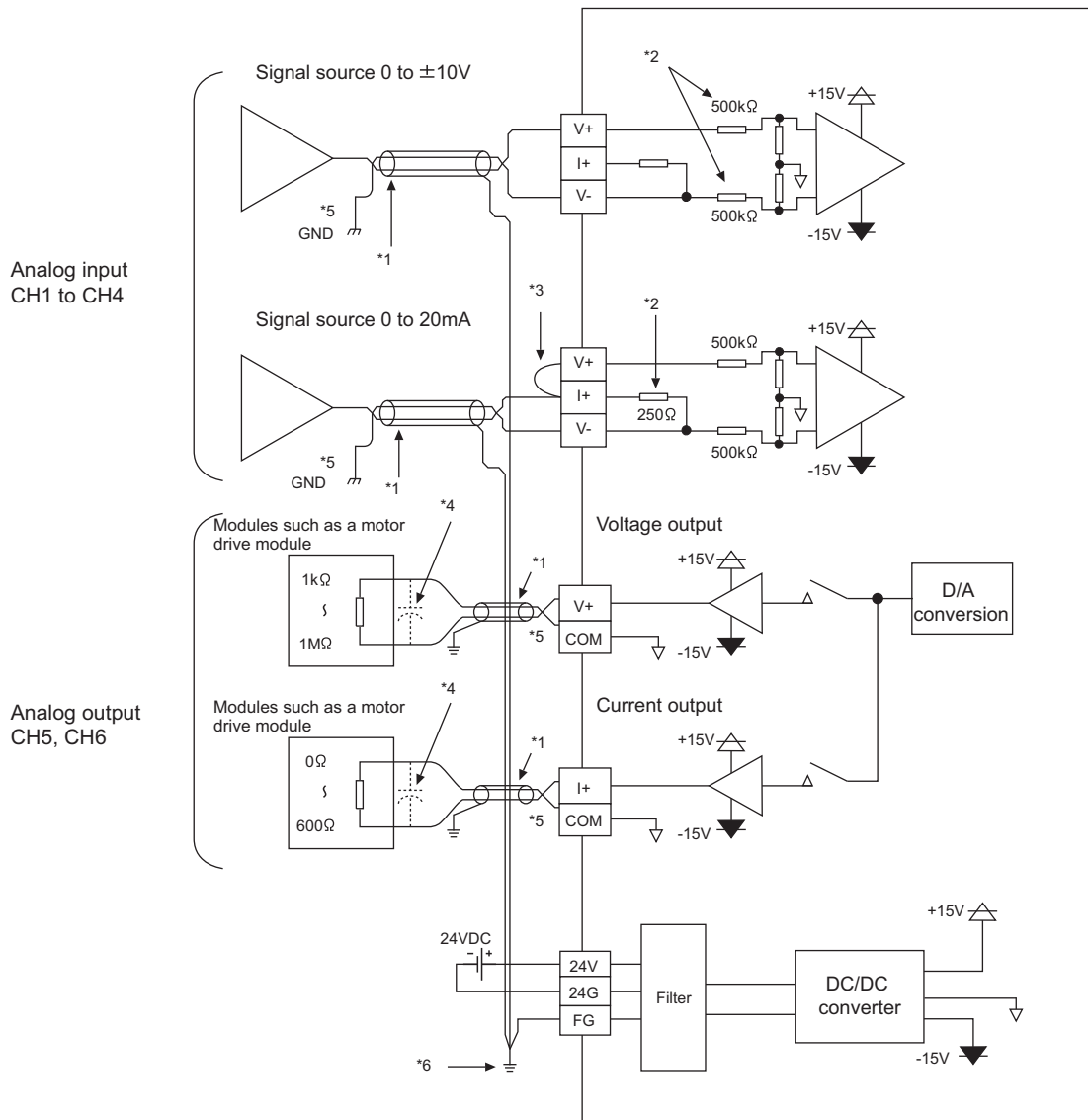

Figure 7.5 External wiring example

- * 1 Use shielded twisted pair cables.
- * 2 The input resistance of the Q64AD2DA is shown.
- * 3 For current input, always connect the V+ terminal and I+ terminal.
- * 4 If noise or a ripple is generated in the external wiring, connect a capacitor of 0.1 to 0.47 μ F25V between the V+ terminal and COM terminal.
- * 5 When there is a potential difference between the COM terminal and the GND terminal for external device, connect the COM terminal and the GND terminal.
- * 6 Always ground the shields of the cables of each channel. Also ground the FG terminal of the power supply module.
- * 7 One output channel cannot be used for both voltage output and current output.
- * 8 Signals may be output from the analog output channels (CH5 and CH6) when external power supply for a programmable controller or a module is turned on or off. Therefore, configure a system that starts controlling after a normal analog signal is output.

7.4.3 Wiring of external power supply connector

The Q64AD2DA requires a power supply (24VDC \pm 15%) to run an analog circuit. Install an external power supply connector with referring to (2) in this section and (3) in this section.

(1) Cables

Use cables that meet the applicable wire size shown in Table 7.4.

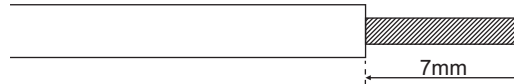
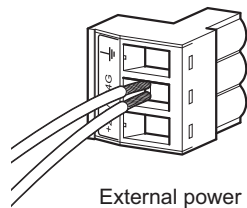

Table 7.4 Applicable wire size

Item		Specifications
Applicable wire size		0.2 to 3.3mm ² (AWG 24 to 12)
Size when inserting two cables into one terminal	Single wire	0.2 to 0.8mm ² × 2
	Stranded wire	0.2 to 0.8mm ² × 2
External power supply connector screw (M3 screw)		0.5 to 0.6N·m



External power supply connector (accessory)

Figure 7.6 When inserting two cables into one terminal

Table 7.5 shows the terminals of external power supply connector.

Table 7.5 Terminals of external power supply connector

Terminal	Signal name
+24V	External power supply 24V +
24G	External power supply 24V -
	Grounding

(2) Wiring method

- 1) Insert a cable to the terminal of external power supply connector.
Check the terminal layout before wiring.
Next, tighten the external power supply connector screw to secure the cable.

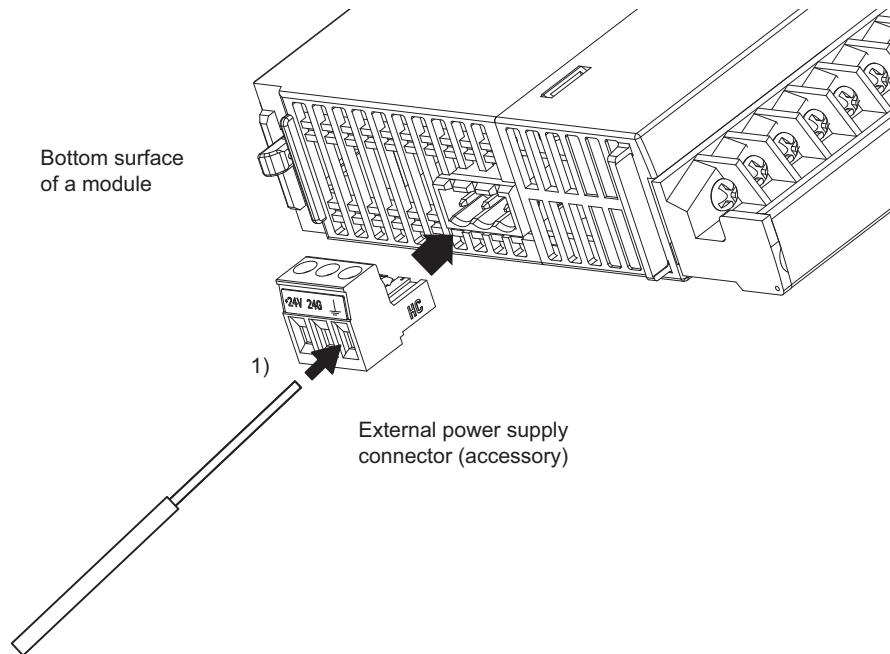

Figure 7.7 Module bottom

- 2) Insert the connector to the terminal until the connector clicks into place.

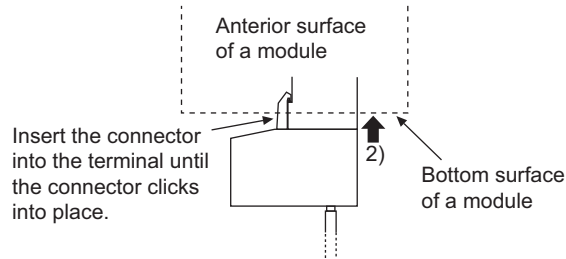

Figure 7.8 Module side

(3) Wiring example

The following figure shows a wiring example of shielded twisted pair cables (example of CH1 analog voltage input).

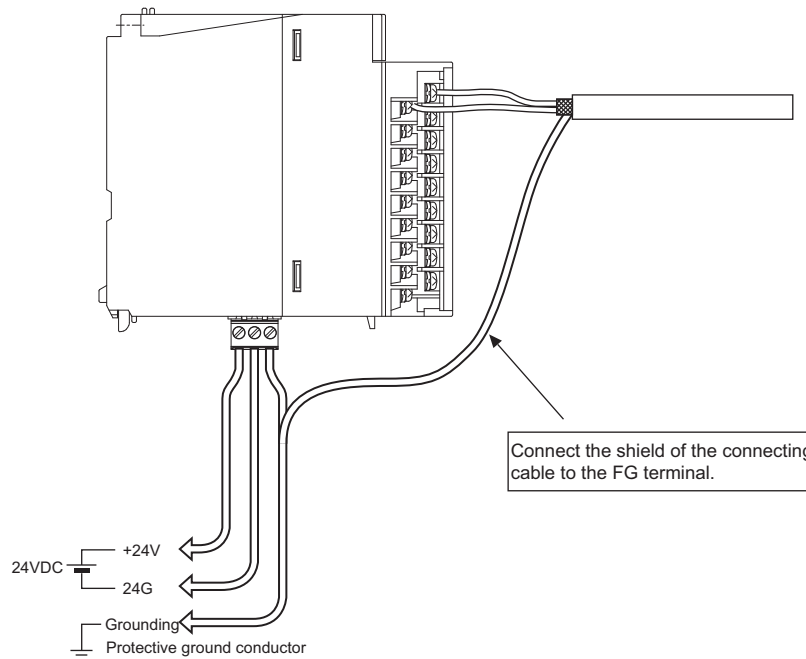

Figure 7.9 Wiring example of shielded twisted pair cable

POINT

When removing an external power supply connector from a module, hold the connector part.

Pulling by the cable part may result in damage to the module or cable or malfunction.

7.5 Setting from GX Developer

This section explains settings configured in GX Developer to operate the Q64AD2DA.

7.5.1 Intelligent function module detailed setting

(1) Purpose

When using the Q64AD2DA in remote I/O station, specify the control CPU.
 When using the Q64AD2DA in usual system configuration (mounted on the main base or extension base), the specification is not required since "Error time output mode" and "H/W error time PLC operation mode" settings will be invalid to the Q64AD2DA.

(2) Operating procedure

- 1) Double-click "PLC Parameter" in the project screen of GX Developer.
- 2) Click the "I/O assignment" tab.
- 3) Set the following items for a slot where the Q64AD2DA is mounted*¹ and click the **Detailed setting** button.

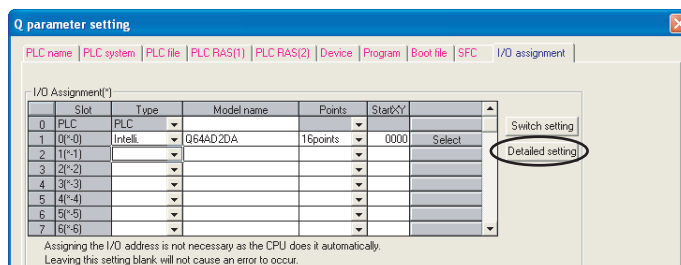

Figure 7.10 "I/O assignment" tab

Table 7.6 Setting items in the "I/O assignment" tab

Item	Description
Type	Select "Intelli."
Model name	Input the model name of the module.
Points	Select "16points".
Start XY	Input the start I/O number of the Q64AD2DA.

* 1 The above dialog box shows an example when the Q64AD2DA is mounted on a slot 0.

- 4) Clicking the **Detailed setting** button opens the "Intelligent function module detailed setting" dialog box.
Configure the setting with referring to the following.

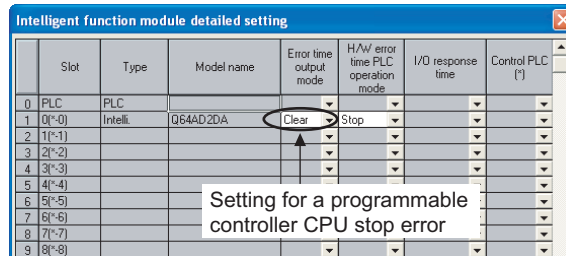

Figure 7.11 "Intelligent function module detailed setting" dialog box

Table 7.7 Setting item in the "Intelligent function module detailed setting" dialog box

Item	Description
Error time output mode	Set whether to clear or hold analog outputs in case of CPU module stop error. Clear: Clears analog outputs in case of link error (default). Hold: Holds analog outputs in case of link error.

7.5.2 Intelligent function module switch setting

Configure input range setting, output range setting, analog output HOLD/CLEAR function setting, and resolution mode setting in this setting.

The intelligent function module switch setting has switches 1 to 5 and is configured with 16-bit data.

If the switch setting is not configured, all the switches are set to 0 by default.

- 1) Configure the settings in the "I/O assignment" tab of GX Developer. (Refer to Section 7.5.1.)

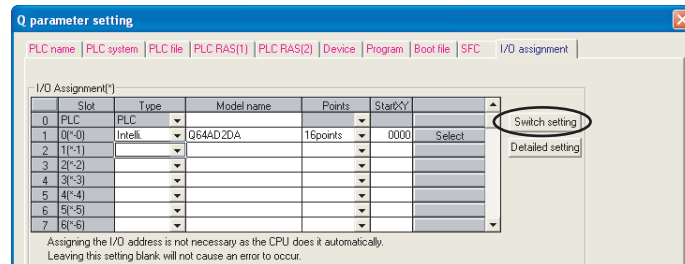

Figure 7.12 "I/O assignment setting" tab

- Clicking the **Switch setting** button opens the "Switch setting for I/O and intelligent function module" dialog box.
Configure the setting with referring to Table 7.8.

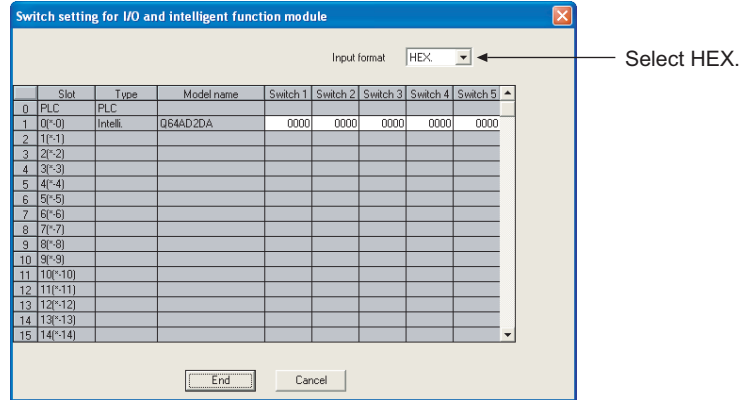

Figure 7.13 "Switch setting for I/O and intelligent function module" dialog box

Table 7.8 Intelligent function module switch setting

Switch	Setting item	Description	Reference section	
Switch 1	<p>Input range setting (CH1 to CH4)</p> <p>CH4 CH3 CH2 CH1</p>	<p>Input range setting (CH1 to CH4)</p> <p>0H: 4 to 20mA 1H: 0 to 20mA 2H: 1 to 5V 3H: 0 to 5V 4H: -10 to 10V 5H: 0 to 10V AH: 4 to 20mA (Extended mode) BH: 1 to 5V (Extended mode)</p>	<p>Set an input range per channel.</p>	<p>Section 3.1 Section 3.2.1</p>
Switch 2	<p>Output range setting (CH5 and CH6)</p> <p>CH6 CH5 Fixed to 0H</p>	<p>Output range setting (CH5 and CH6)</p> <p>0H: 4 to 20mA 1H: 0 to 20mA 2H: 1 to 5V 3H: 0 to 5V 4H: -10 to 10V</p>	<p>Set an output range per channel.</p>	<p>Section 3.1 Section 3.2.2</p>
Switch 3	<p>Analog output HOLD/CLEAR function setting (CH5 and CH6)</p> <p>CH6 CH5 Fixed to 0H</p>	<p>Setting of the analog output HOLD/CLEAR function (CH5 and CH6)</p> <p>0H: CLEAR 1H to FH (A numeral other than 0H)*1: HOLD</p>	<p>Set the analog output HOLD/CLEAR function per channel.</p>	<p>Section 4.3.2</p>
Switch 4	<p>Mode setting*2</p> <p>Fixed to 00H 0H : Normal resolution mode 1H to FH (A value other than 0H)*1: High resolution mode Fixed to 0H</p>	<p>Set a mode.</p>	<p>Section 3.1 Section 3.2</p>	
Switch 5	<p>Fixed to 0H</p>	-	-	

* 1 Setting any values within the setting range will provide the same operation. When the setting range is 1H to FH, set 1H for example.

* 2 The mode setting is reflected to all channels (both A/D and D/A conversions).

- When the setting is completed, click the **End** button.

7.6 Offset/Gain Correction

The offset/gain can be corrected using the scaling function and shift function.
The offset/gain correction examples are shown on the following pages.

1

OVERVIEW

2

SYSTEM
CONFIGURATION

3

SPECIFICATIONS

4

FUNCTION

5

I/O SIGNALS FOR
THE CPU MODULE

6

BUFFER MEMORY

7

PREPARATORY
PROCEDURES AND
SETTING

8

UTILITY PACKAGE
(GX Configurator-AD/GX
Configurator-DA)

(1) A/D conversion

Example) When executing offset/gain correction under the following condition

A/D conversion example before correction	Analog input value	Scaling value	A/D conversion example after correction	Analog input value	Scaling value
	0mA	+3		0mA	0
	20mA	+4008		20mA	+4000

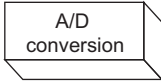

[Setting range: 0 to 20mA]
< -4000 ~ 4000 >

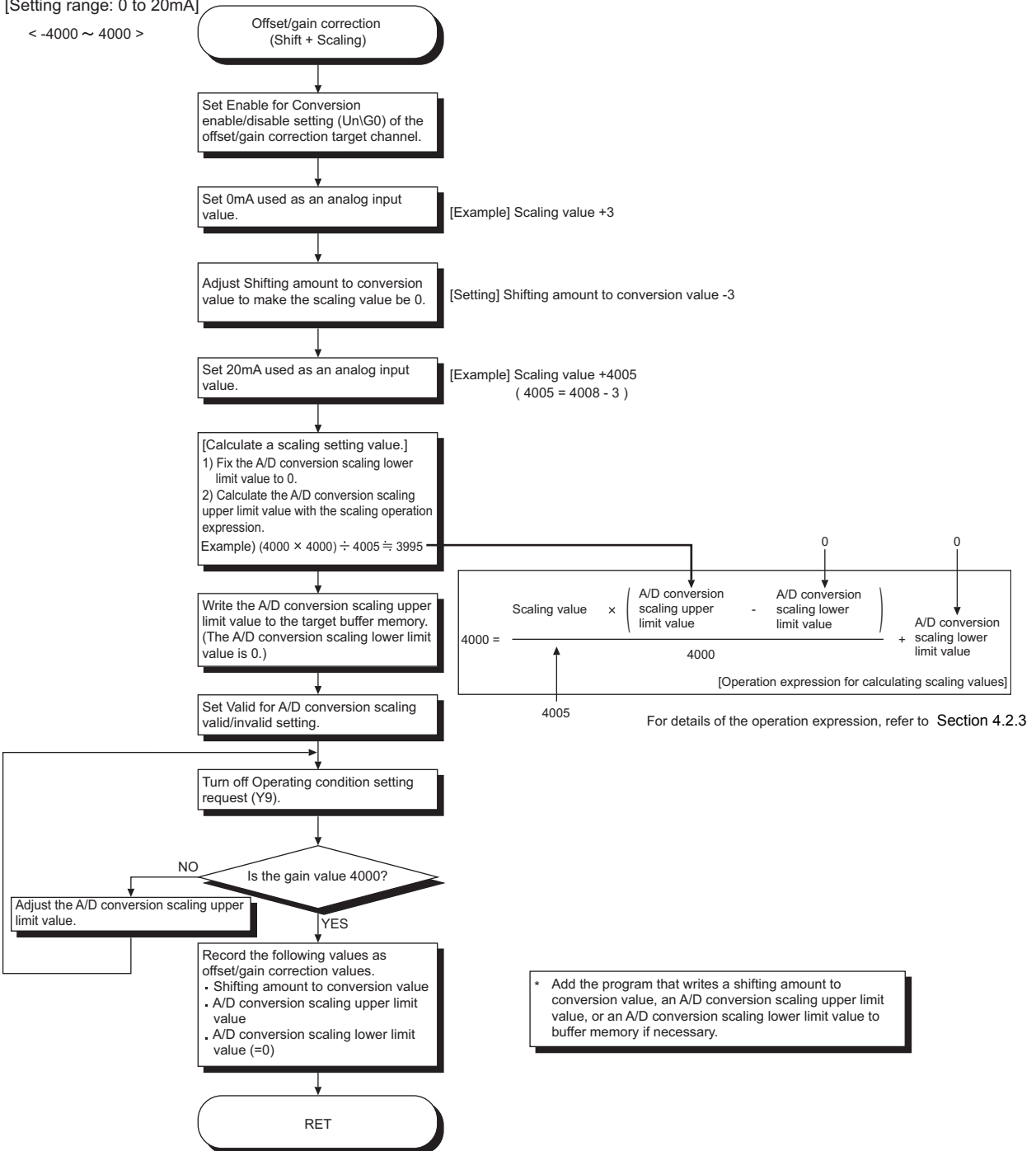

Figure 7.14 Offset/gain correction example (A/D conversion)

POINT

- (1) When offset/gain are corrected using the scaling function and shift function, resolution may be reduced. In the example of Figure 7.14, the resolution is reduced at 0.125%.
- (2) When offset/gain are corrected using the scaling function and shift function, the functions cannot be used for other applications.
- (3) When a module is replaced online, corrected offset/gain data are not taken over to a new module. Correct the offset/gain following the procedures in Figure 7.14 after online change.

(2) D/A conversion

Example: When executing offset/gain correction under the following condition

D/A conversion example before correction	Digital input value	Analog output value	D/A conversion example after correction	Digital input value	Analog output value
	0	0.2mA		0	0.0mA
	4000	20.3mA		0	20.0mA

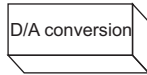

[Setting range: 0 to 20mA]
< -4000 ~ 4000 >

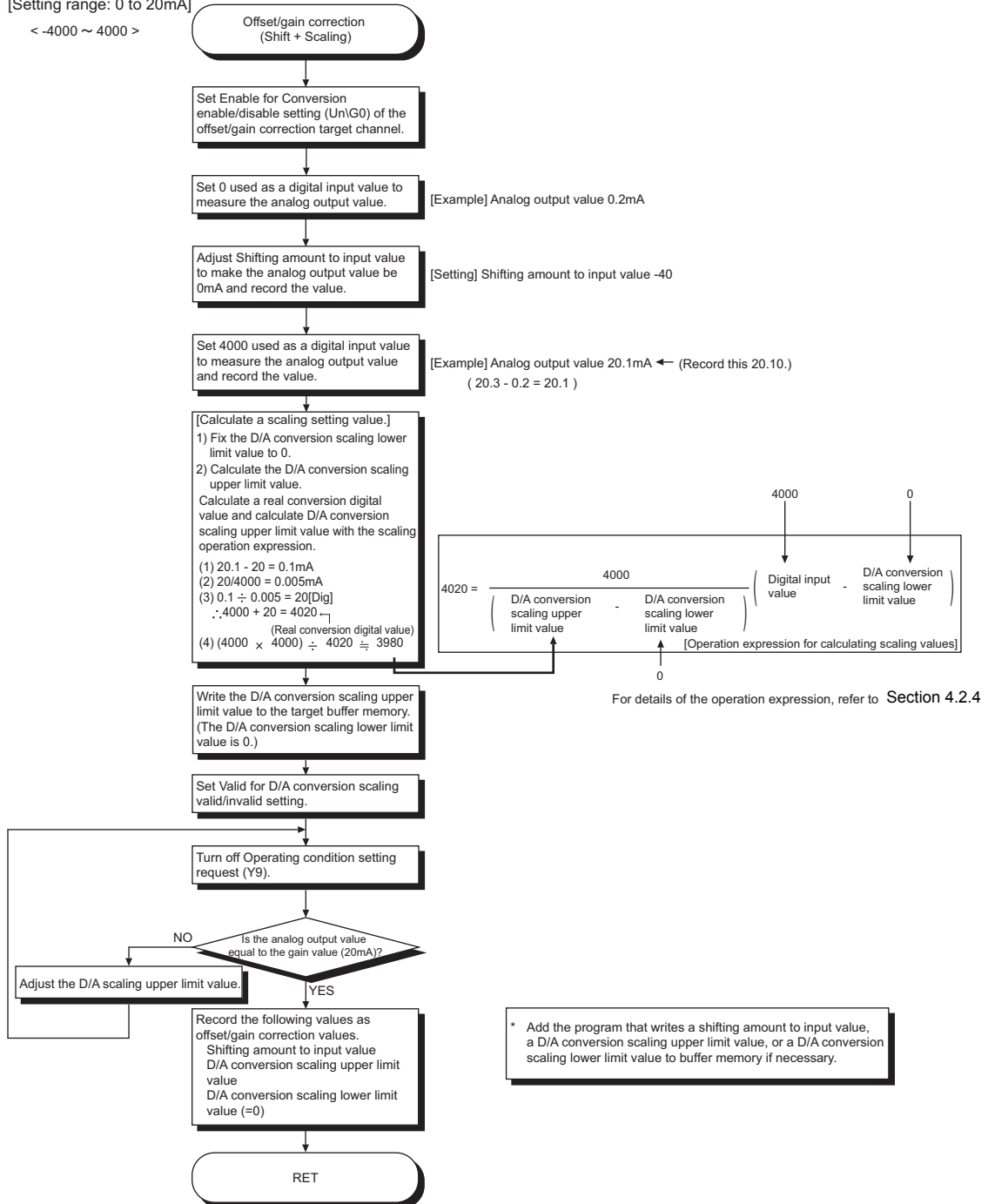

Figure 7.15 Offset/gain correction example (D/A conversion)

POINT

- (1) When offset/gain are corrected using the scaling function and shift function, resolution may be reduced. In the example of Figure 7.15, the resolution is reduced at 0.5%.
- (2) When offset/gain are corrected using the scaling function and shift function, the functions cannot be used for other applications.
- (3) When a module is replaced online, corrected offset/gain data are not taken over to a new module. Correct the offset/gain following the procedures in Figure 7.15 after online change.

CHAPTER8 UTILITY PACKAGE (GX Configurator-AD/GX Configurator-DA)

8.1 Utility Package Functions

Table 8.1 lists the functions of the utility package.

Table 8.1 Function list

Item	Description	Reference section
Initial setting	<p>(1) The initial values of the following items are set for each channel.</p> <p>(a) A/D conversion area</p> <ul style="list-style-type: none"> •A/D conversion/enable disable setting •Averaging process method setting •Averaging process (time/number of times) setting •A/D conversion scaling enable/disable setting •A/D conversion scaling lower limit value •A/D conversion scaling upper limit value •Shifting amount to conversion value •Input signal error detection setting •Input signal error detection setting value •Logging enable/disable setting •Logging cycle unit setting •Logging cycle setting value •Logging data setting •Logging points after trigger •Level trigger condition setting •Trigger data •Trigger setting value <p>(b) D/A conversion area</p> <ul style="list-style-type: none"> •D/A conversion enable/disable setting •D/A conversion scaling enable/disable setting •D/A conversion scaling lower limit value •D/A conversion scaling upper limit value •Shifting amount to input value <p>(2) The initial setting data are registered with parameters of the CPU module and automatically written to the Q64AD2DA when the CPU module enters in the RUN status.</p>	Section 8.4
Auto refresh setting	<p>(1) Buffer memory of the Q64AD2DA to be auto-refreshed is set.</p> <p>(2) Buffer memory of the Q64AD2DA with the auto refresh setting is automatically read and written to the specified device when the END instruction for the CPU module is executed.</p>	Section 8.5
Monitor/Test	<p>(1) Monitor/Test The buffer memory and I/O signals of the Q64AD2DA are monitored and tested.</p> <p>(2) Maximum value/minimum value information The maximum/minimum digital output values and the maximum/minimum scaling values are monitored and reset.</p> <p>(3) Operating condition setting Initial setting items are changed during operation and detection status of input signal error is monitored.</p>	Section 8.6
FB conversion	<p>(1) An intelligent function module parameter (initial setting/auto refresh setting) is automatically converted into an FB.</p>	Section 8.7

8.2 Installing and Uninstalling the Utility Package

For how to install or uninstall the utility package, refer to "Method of installing the MELSOFT Series" included in the utility package.

8.2.1 Precautions for use

This section provides precautions for using GX Configurator-AD and GX Configurator-DA.*1

* 1 Using either of the utilities can check the parameter settings of intelligent function module, setting status, and operating status of A/D and D/A conversions.
They can also be checked when both GX Configurator-AD and GX Configurator-DA have been installed.

(1) For safety use

Read "Safety Precautions" and the basic operations described in the GX Developer Operating Manual since GX Configurator-AD and GX Configurator-DA are add-in software for GX Developer.

(2) Installation

GX Configurator-AD and GX Configurator-DA are add-in software for GX Developer Version 4 or later.

Therefore, install GX Configurator-AD or GX Configurator-DA on the personal computer on which GX Developer Version 4 or later has been installed.

(3) Display error when using Intelligent function module utility

Due to insufficient system resource, the screen may not be normally displayed while Intelligent function module utility is used.

In this case, exit Intelligent function module utility, GX Developer (such as a program and comments), and other applications, and then start GX Developer and Intelligent function module utility.

(4) Starting Intelligent function module utility

- (a) Select "QCPU (Q mode)" in "PLC series" of GX Developer and set a project.
If not, Intelligent function module utility does not start.
- (b) Multiple Intelligent function module utilities can be started.
However, only one Intelligent function module utility can operate [Open parameters] and [Save parameters] in the intelligent function module parameter.
The other utilities can operate [Monitor/test] only.

(5) Window switching among multiple Intelligent function module utilities

When multiple Intelligent function module utility windows cannot be simultaneously viewed, select a screen to be displayed to the foreground with the task bar.



Figure 8.1 Display example of the task bar

(6) The number of parameters that can be set with GX Configurator-AD and GX Configurator-DA

When multiple intelligent function modules are mounted, set parameters within the following settable numbers.

Table 8.2 The number of parameters that can be set with GX Configurator-AD and GX Configurator-DA

Modules mounted with intelligent function modules or a station on which the modules are mounted	Settable number of parameters	
	Initial setting	Auto refresh setting
Q00J/Q00/Q01CPU	512	256
Q02/Q02H/Q06H/Q12H/Q25HCPU	512	256
Q02PH/Q06PH/Q12PH/Q25PHCPU	512	256
Q12PRH/Q25PRHCPU	512	256
Q00UJ/Q00U/Q01UCPU	512	256
Q02UCPU	2048	1024
Q03UD/Q04UDH/Q06UDH/Q10UDH/ Q13UDH/Q20UDH/Q26UDH/Q03UDE/ Q04UDEH/Q06UDEH/Q10UDEH/ Q13UDEH/Q20UDEH/Q26UDEHCPU	4096	2048
CPU modules other than the above	Cannot be used	Cannot be used
MELSECNET/H remote I/O station	512	256

For example, when multiple intelligent function modules are mounted on the MELSECNET/H remote I/O station, set GX Configurator-AD or GX Configurator-DA so that the number of parameters set for all the intelligent function modules may not exceed the settable number of parameters for the MELSECNET/H remote I/O station. Count the number of parameters set in the initial setting and the auto refresh setting separately.

The number of parameters that can be set for one module with GX Configurator-AD and GX Configurator-DA are as shown below.

Table 8.3 The number of parameters that can be set for one module

Module	Initial setting	Auto refresh setting
Q64AD2DA	GX Configurator-AD	61 (Max.)
	GX Configurator-DA	

Example) Counting the number of set parameters in the auto refresh setting

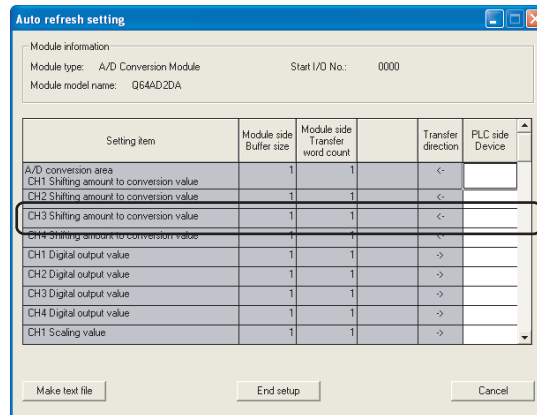

← This one row is counted as one setting. Blank rows are not counted. Count up all the setting items on this window, and add the total to the number of settings for other intelligent function modules to get a grand total.

Figure 8.2 Parameter setting (Auto refresh setting window)

1

OVERVIEW

2

SYSTEM CONFIGURATION

3

SPECIFICATIONS

4

FUNCTION

5

I/O SIGNALS FOR THE CPU MODULE

6

BUFFER MEMORY

7

PREPARATORY PROCEDURES AND SETTING

8

UTILITY PACKAGE (GX Configurator-AD/GX Configurator-DA)

8.2.2 Operating environment

This section explains the operating environment of the personal computer that runs GX Configurator-AD and GX Configurator-DA.

Table 8.4 Operating environment

Item	Description	
Installation (add-in) location ^{*1}	GX Developer Version 4 (English version) or later ^{*2}	
Personal computer	Windows® -based personal computer	
CPU	Refer to Table 8.5 "Operating system and performance required for personal computer" on the following page.	
Required memory		
Hard disk free space	For installation	65MB or more
	For operation	20MB or more
Display	Resolution of 800 × 600 pixels or more ^{*3}	
Operating system	Microsoft® Windows® 95 Operating System (English version) Microsoft® Windows® 98 Operating System (English version) Microsoft® Windows® Millennium Edition Operating System (English version) Microsoft® Windows NT® Workstation Operating System Version 4.0 (English version) Microsoft® Windows® 2000 Professional Operating System (English version) Microsoft® Windows® XP Professional Operating System (English version) Microsoft® Windows® XP Home Edition Operating System (English version) Microsoft® Windows Vista® Home Basic Operating System (English version) Microsoft® Windows Vista® Home Premium Operating System (English version) Microsoft® Windows Vista® Business Operating System (English version) Microsoft® Windows Vista® Ultimate Operating System (English version) Microsoft® Windows Vista® Enterprise Operating System (English version) Microsoft® Windows® 7 Starter Operating System (English version) ^{*4} Microsoft® Windows® 7 Home Premium Operating System (English version) ^{*4} Microsoft® Windows® 7 Professional Operating System (English version) ^{*4} Microsoft® Windows® 7 Ultimate Operating System (English version) ^{*4} Microsoft® Windows® 7 Enterprise Operating System (English version) ^{*4}	

* 1 Install GX Configurator-AD or GX Configurator-DA of the same language with GX Developer Version 4 or later that has been installed.

The following combinations are inapplicable (GX Configurator-AD).

- GX Developer (Japanese version) and GX Configurator-AD (English version)
- GX Developer (English version) and GX Configurator-AD (Japanese version)

The same applies to GX Configurator-DA.

* 2 GX Configurator-AD and GX Configurator-DA cannot be used as an add-in software for GX Developer Version 3 or earlier.

* 3 Resolution of 1024 × 768 pixels or more is recommended for Windows Vista® and Windows® 7.

* 4 For Windows® 7 (32-bit version), install GX Configurator-AD Version 2.11M or later as an add-in to GX Developer Version 8.91V or later.

For Windows® 7 (64-bit version), install GX Configurator-AD Version 2.12N or later as an add-in to GX Developer Version 8.98C or later.

Table 8.5 Operating system and performance required for personal computer

Operating system	Performance required for personal computer	
	CPU	Memory
Windows® 95	Pentium® 133MHz or more	32MB or more
Windows® 98	Pentium® 133MHz or more	32MB or more
Windows® Me	Pentium® 150MHz or more	32MB or more
Windows NT® Workstation 4.0	Pentium® 133MHz or more	32MB or more
Windows® 2000 Professional	Pentium® 133MHz or more	64MB or more
Windows® XP	Pentium® 300MHz or more	128MB or more
Windows Vista®	Pentium® 1GHz or more	1GB or more
Windows® 7	Pentium® 1GHz or more	1GB or more (for 32-bit version) 2GB or more (for 64-bit version)

POINT

- (1) The following functions are not available for Windows® XP, Windows Vista®, and Windows® 7.
Using the functions below may cause this product to fail to operate normally:
 - Application start in Windows® compatible mode
 - Fast user switching
 - Remote desktop
 - Large Fonts ("Advanced" setting in the Display Properties dialog box)
 - DPI settings other than 100%
 In addition, Windows® XP (64-bit version) and Windows Vista® (64-bit version) are not supported.
- (2) On Windows Vista® and Windows® 7, the user should have USER authority or higher.
- (3) The following functions are not available for Windows® 7:
 - Windows XP Mode
 - Windows Touch

8.3 Operating the Utility Package

8.3.1 Common operations

(1) Control keys

The following table shows control keys that can be used for utility operation and their applications.

Table 8.6 Control keys that can be used

Key	Application
Esc	Cancels a newly input value in a cell or exits the screen.
Tab	Moves among controls in the screen.
Ctrl	Used with the mouse to select multiple cells for test operation ("Execute test").
Delete	Deletes a character at the cursor position. When a cell is selected, this key deletes all the data in the cell.
Back Space	Deletes a character at the cursor position.
↑ ↓ ← →	Moves the cursor.
Page Up	Moves the cursor up one page.
Page Down	Moves the cursor down one page.
Enter	Saves a value input in a cell.

(2) Data created with the utility package

The following data and files to be created with the utility package are also be used for GX Developer. Figure 8.4 shows which data and files are used in which operation.

(a) Intelligent function module paramete

This parameter is created by the auto refresh setting and stored in an intelligent function module parameter file in a project created with GX Developer.

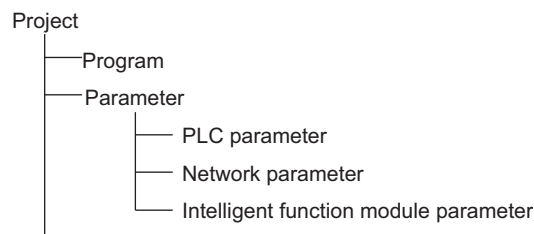

Figure 8.3 Project hierarchy

(b) Text file

A text file is created by clicking the **Make text file** button in the Initial setting window, Auto refresh setting window, and Monitor/Test window.

The file can be utilized to create user documents.

Figure 8.4 shows when GX Configurator-AD is used.

The same applies to GX Configurator-DA.

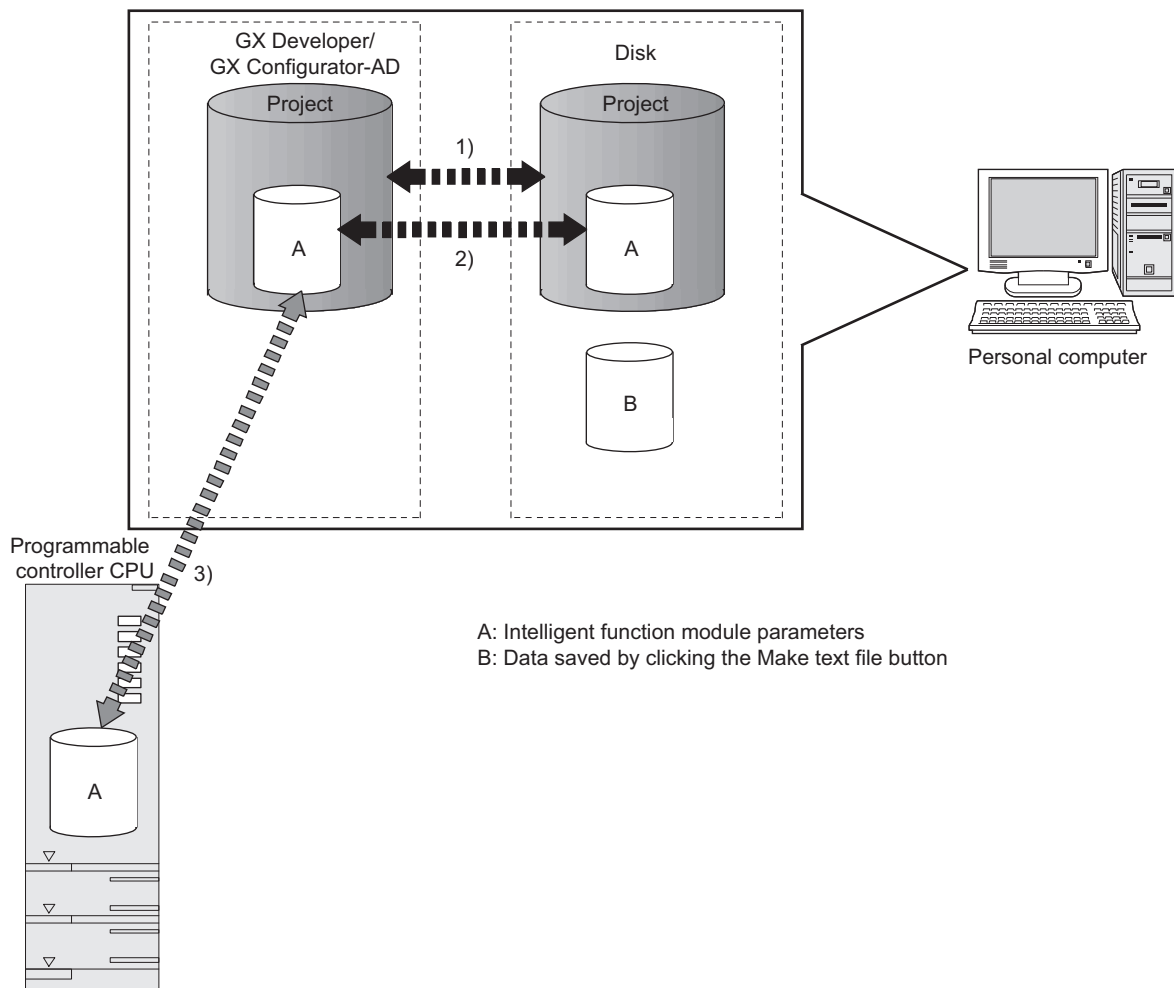

Figure 8.4 Correlation diagram of data created with the utility package

Steps 1) to 3) shown in Figure 8.4 are performed as follows:

- 1) In GX Developer, select:
[Project] → [Open project]/[Save]/[Save as].
- 2) In the screen for selecting a target intelligent function module of the utility package, select:
[Intelligent function module parameter] → [Open parameters]/[Save parameters].
- 3) In GX Developer, select:
[Online] → [Read from PLC]/[Write to PLC] → "Intelligent function module parameters".
Or, in the screen for selecting a target intelligent function module of the utility package, select:
[Online] → [Read from PLC]/[Write to PLC].

8.3.2 Operation overview

Figure 8.5 shows operations using the GX Configurator-AD window. The same operations apply to GX Configurator-DA.

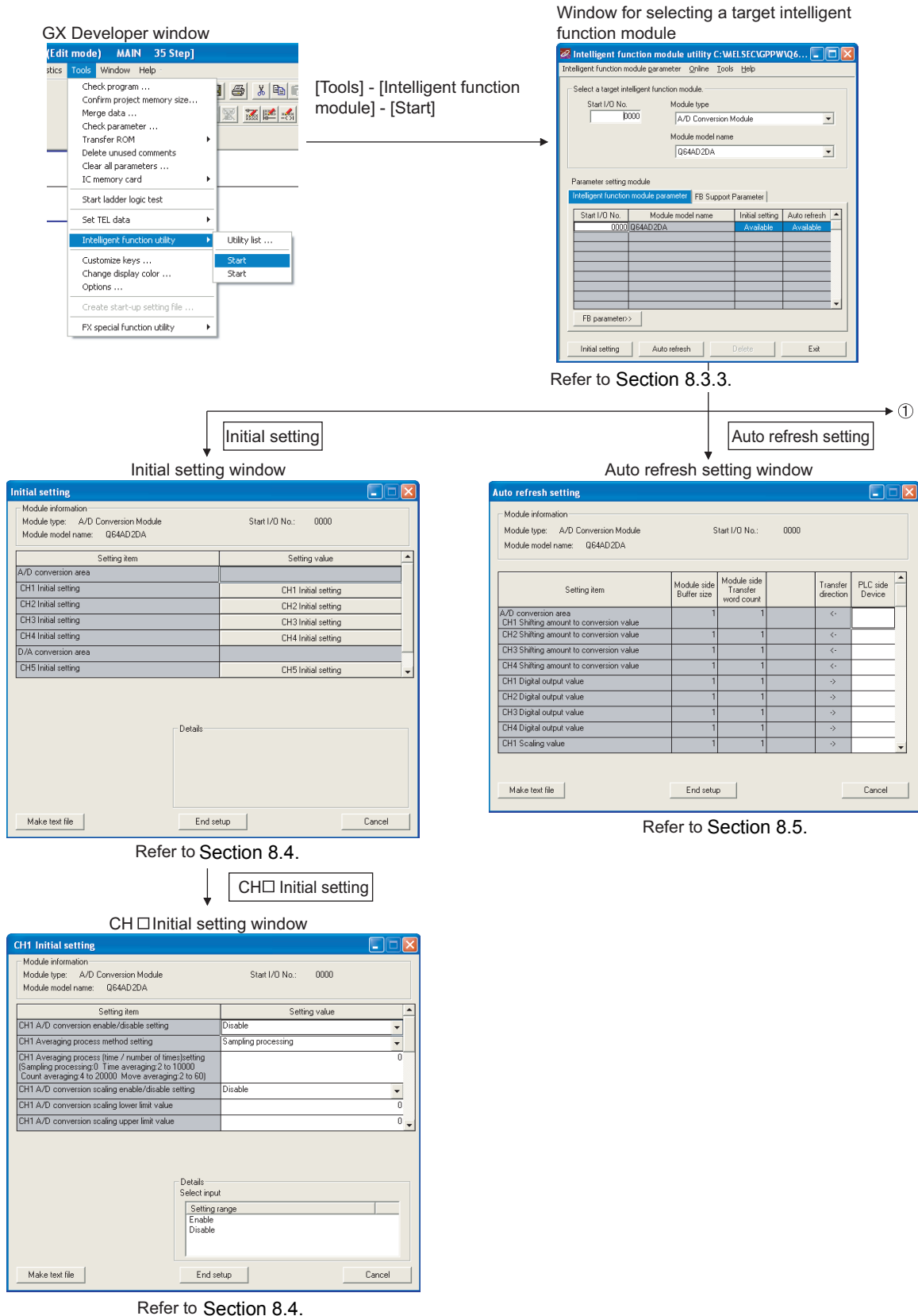
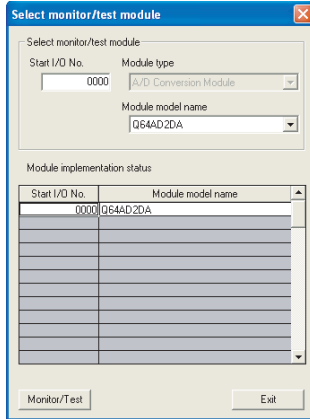

Figure 8.5 Operation overview

① [Online] - [Monitor/Test] FB Support Parameter tab - [FB conversion]

Select monitor/test module dialog box



FB conversion dialog box

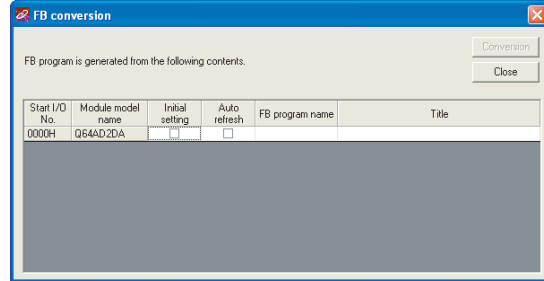

Refer to Section 8.7.

Select a module to be monitored/tested.

Monitor/Test window

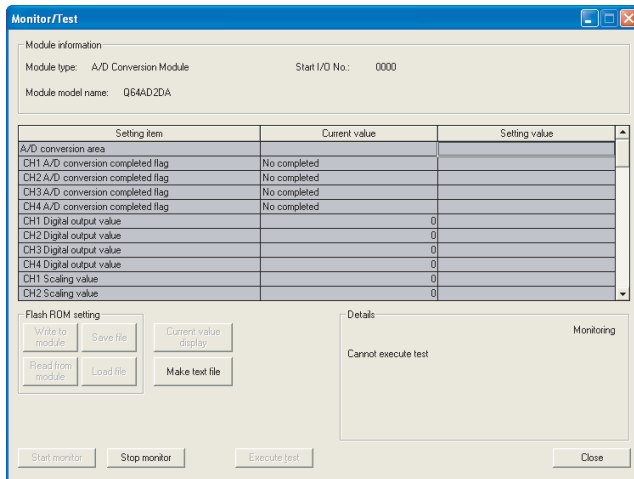

Refer to Section 8.6.

Figure 8.5 Operation overview (continued)

8.3.3 Starting Intelligent function module utility

[Operating procedure]

Start Intelligent function module utility from GX Developer.

Select [Tools] → [Intelligent function utility] → [Start].

[Setting window]

The following shows a window when the "FB Support Parameter" tab is activated.

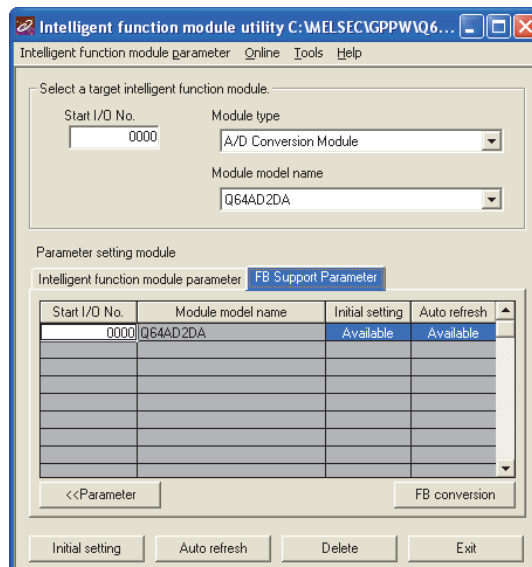

Figure 8.6 Window for selecting a target intelligent function module

[Description]

(1) Display of other screens

Open the following screens from the Intelligent function module utility window (common to the "Intelligent function module parameter" tab and the "FB Support Parameter" tab).

(a) Initial setting window

Input "Start I/O No."^{*1}. → Select "Module type". → Select "Module model name". → Click the **Initial setting** button.

(b) Auto refresh setting window

Input "Start I/O No."^{*1}. → Select "Module type". → Select "Module model name". → Click the **Auto refresh** button.

(c) Select monitor/test module dialog box

Select [Online] → [Monitor/Test].

* 1 Input a start I/O number in hexadecimal.

When the "FB Support Parameter" tab is activated

(d) Display of the FB conversion dialog box

"FB Support Parameter" tab → Click the **FB conversion** button.

For details, refer to Section 8.7.

POINT

The "FB Support Parameter" tab opens when a project being edited is a label project.

(2) Command buttons

Common to the "Intelligent function module parameter" tab and the "FB Support Parameter" tab

Delete

Deletes the initial setting and auto refresh setting configured to the selected module.

If both the initial setting and auto refresh setting have been set but either an "Initial setting" cell or "Auto refresh" cell is selected and this button is clicked, only the setting of the selected cell is deleted.

Exit

Exits Intelligent function module utility.

When the "FB Support Parameter" tab is activated

<<Parameter

Moves the settings in the selected line to the line in the same position in the "Intelligent function module parameter" tab.

When the "Intelligent function module parameter" tab is activated

FB parameter>>

Moves the settings in the selected line to the line in the same position in the "FB Support Parameter" tab.

(3) Menu bar**(a) File menu**

Intelligent function module parameters of a project opened with GX Developer can be operated.

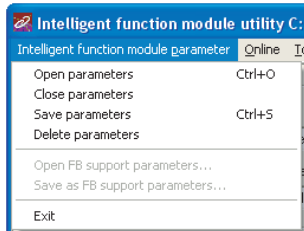

- | | |
|---------------------------------|---|
| [Open parameters] | : Reads a parameter file. |
| [Close parameters] | : Closes a parameter file. If the file has been modified, a dialog box asking for save will appear. |
| [Save parameters] | : Saves a parameter file. |
| [Delete parameters] | : Deletes a parameter file. |
| [Open FB support parameters] | : Opens an FB support parameter file. |
| [Save as FB support parameters] | : Saves an FB support parameter file. |
| [Exit] | : Exits Intelligent function module utility. |

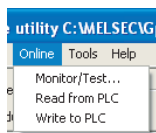
(b) Online menu

- | | |
|-----------------|---|
| [Monitor/Test] | : Displays the Select monitor/test module dialog box. |
| [Read from PLC] | : Reads intelligent function module parameters from the CPU module. |
| [Write to PLC] | : Writes intelligent function module parameters to the CPU module. |

POINT

- (1) Saving intelligent function module parameters in a file
Save intelligent function module parameters by the operation in the window for selecting a target intelligent function module shown above since they cannot be saved in a file by the project save operation with GX Developer.
- (2) Reading/writing intelligent function module parameters using [Read from PLC]/[Write to PLC] of GX Developer
 - [Read from PLC] and [Write to PLC] can be performed after intelligent function module parameters are saved in a file.
 - Select [Online] → [Transfer setup] in GX Developer and set the target CPU module.
 - When mounting the Q64AD2DA on a remote I/O station, use "Read from PLC" and "Write to PLC" of GX Developer.
- (3) Checking required utility
While the start I/O number is displayed in the Intelligent function module utility window, " * " may be displayed in the "Module model name" field.
This means that the required utility has not been installed or the installed utility cannot be started from GX Developer.
Check the required utility by selecting [Tools] → [Intelligent function utility] → [Utility list] in GX Developer and take necessary measures.

8.4 Initial Setting

[Purpose]

Configure initial setting to operate the Q64AD2DA for each channel.

For the types of initial setting parameters, refer to Section 8.1.

Setting parameters in the Initial setting window can omit parameter settings with sequence program.

[Operating procedure]

Input "Start I/O No."*1. → Select "Module type". → Select "Module model name". →

Click the **Initial setting** button.

* 1 Input a start I/O number in hexadecimal.

[Setting window]

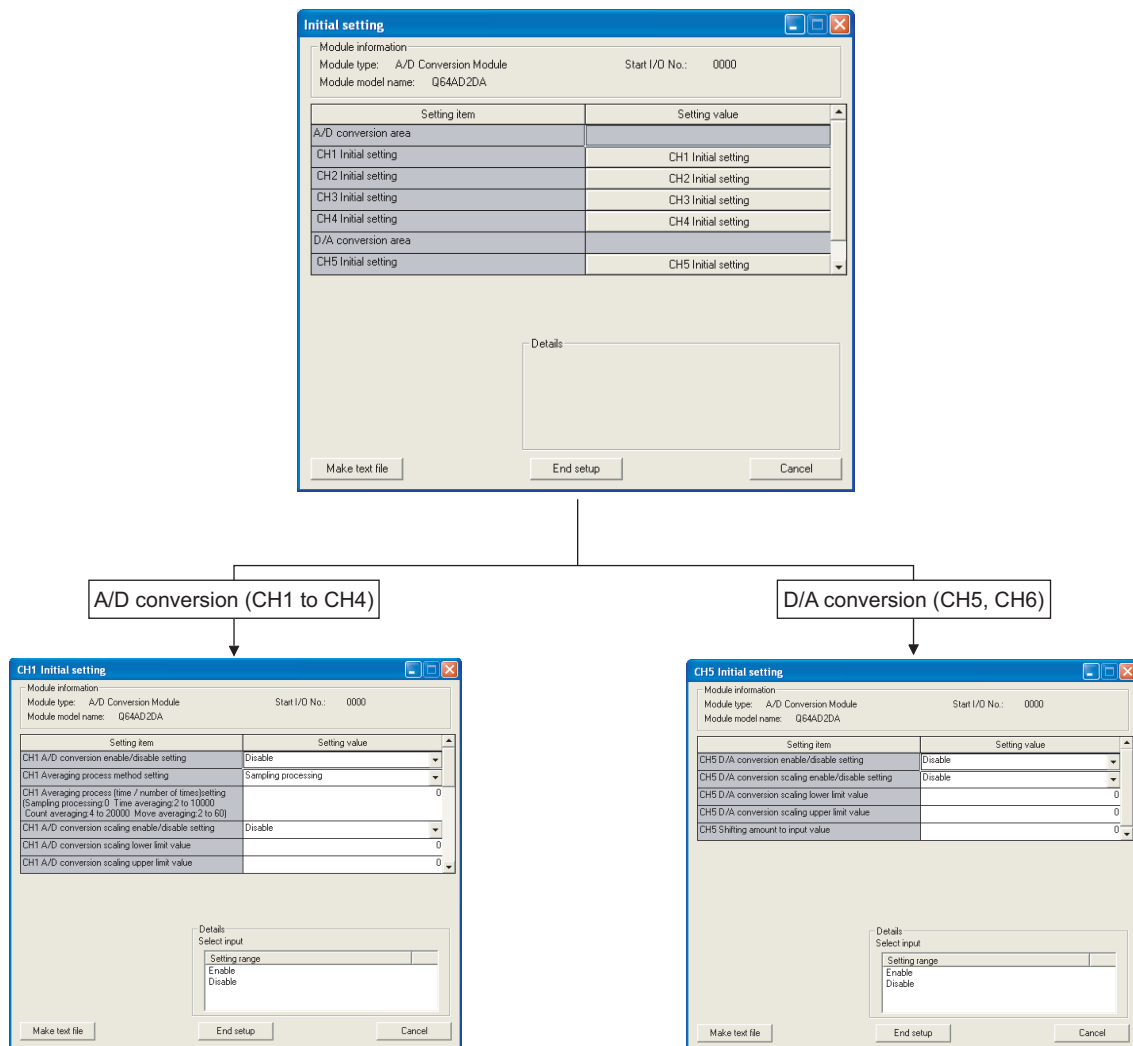

Figure 8.7 "Initial setting" windows

[Description]

(1) Setting items

Set A/D conversion, D/A conversion enable/disable, and averaging process method for each channel.

(2) Command buttons

Writes data displayed in the window to a file in text file format.

Saves settings and exits the window.

Cancels settings and exits the window.

☒ POINT

The initial setting is stored to an intelligent function module parameter.

After the initial setting is written to the CPU module, it becomes valid by operation of either (1) or (2).

(1) Switch the RUN/STOP switch of the CPU module in the order of STOP, RUN, STOP, and RUN.

(2) With the RUN/STOP switch set to RUN, power off and then on or reset the CPU module.

When using a sequence program, the initial setting parameters are written at the time the CPU module status changes from STOP to RUN. So, create the sequence program so that the initial setting will be reexecuted.

8.5 Auto Refresh Setting

[Purpose]

Set buffer memory of the Q64AD2DA to be auto-refreshed.

[Operating procedure]

Input "Start I/O No."*1. → Select "Module type". → Select "Module model name". → Click the **Auto refresh** button.

* 1 Input a start I/O number in hexadecimal.

[Setting window]

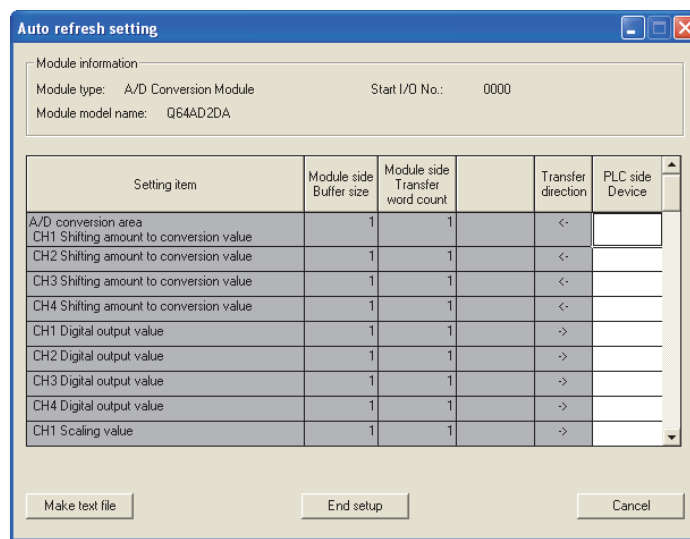

Figure 8.8 "Auto refresh setting" window

[Description]

(1) Display items

Module side Buffer : Displays the transferable buffer memory size of the setting size (fixed at one word).

Module size Transfer : Displays the number of words that are transferred, starting from a device set at "PLC side Device" (fixed at one word).

Transfer direction : "**<-**" indicates that data are written from the device to the buffer memory.
"**->**" indicates that data are read from the buffer memory to the device.

PLC side Device : Input a CPU module device to be auto-refreshed.
Usable devices are X, Y, M, L, B, T, C, ST, D, W, R, and ZR.
When using a bit device, X, Y, M, L, or B, set a number that can be divided by 16 points (example: X10, Y120, M16).
Buffer memory data are stored by 16 points, starting from the device whose number was specified.
For example, if X10 is set, data are stored X10 to X1F.

(2) Command buttons**Make text file**

Writes data displayed in the window to a file in text file format.

End setup

Saves settings and exits the window.

Cancel

Cancels settings and exits the window.

POINT

The auto refresh setting is stored to an intelligent function module parameter. After being written to the CPU module, the auto refresh setting takes effect by either (1) or (2).

(1) Switch the RUN/STOP switch of the CPU module in the order of STOP, RUN, STOP, and RUN.

(2) With the RUN/STOP switch set to RUN, power off and then on reset the CPU module.

The auto refresh setting cannot be changed from the sequence program.

However, processing equivalent to auto refresh can be added to the sequence program using the FROM/TO instructions.

8.6 Monitor/Test

8.6.1 Monitor/Test window

[Purpose]

Start monitoring/testing the buffer memory and I/O signals, and "Operating condition setting" from this window.

[Operating procedure]

Select monitor/test module dialog box → Input "Start I/O No."^{*1}. → Select "Module type". → Select "Module model name". → Click the **Monitor/Test** button.

* 1 Input a start I/O number in hexadecimal.

The window can also be displayed from the System Monitor dialog box of GX Developer Version 6 or later.

For details, refer to the GX Developer Operating Manual.

[Setting window]

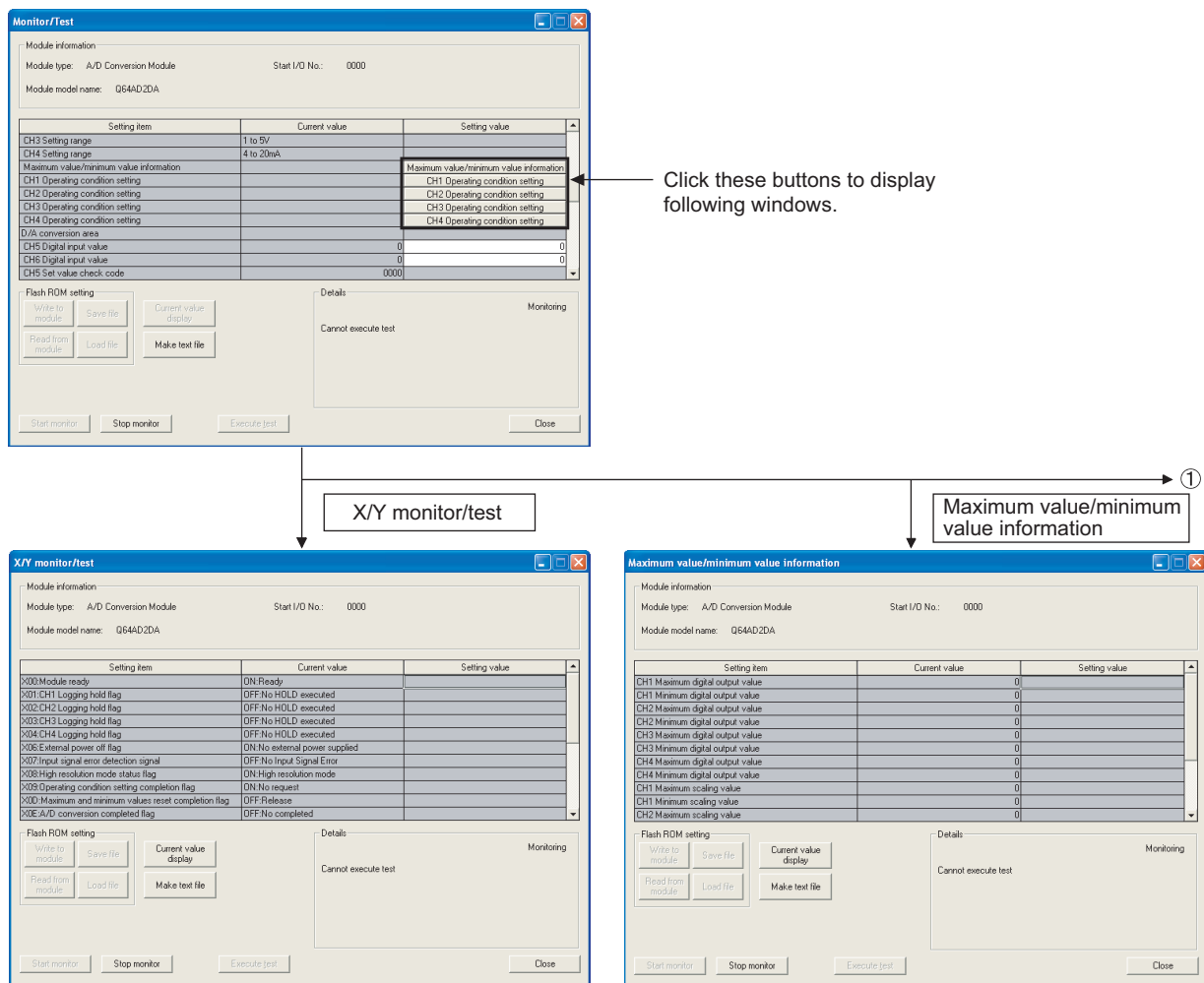

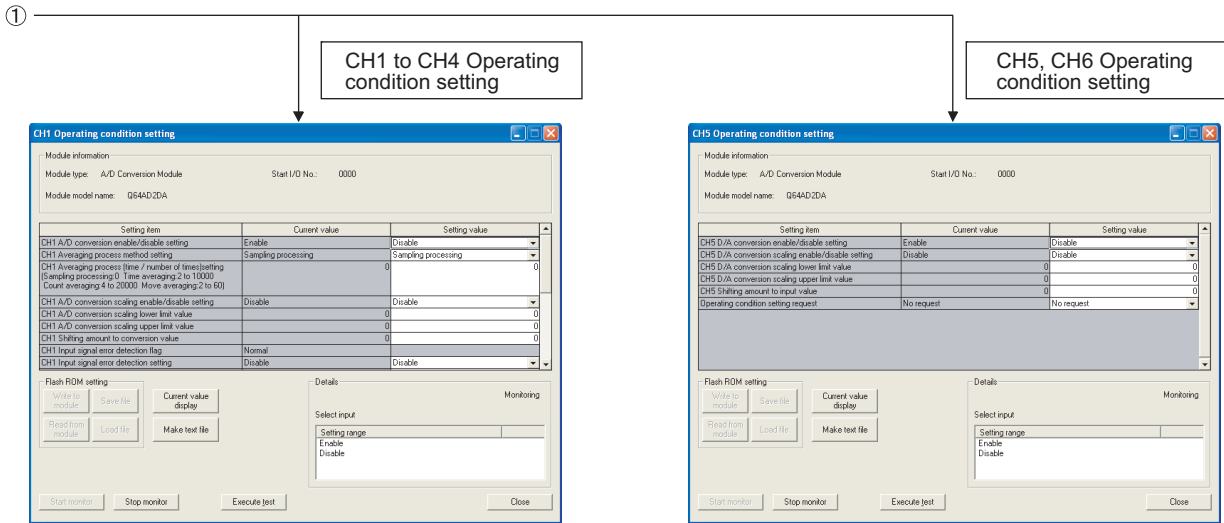

Figure 8.9 "Monitor/Test" window (continued)

[Description]

(1) Display items

- Setting item : Displays I/O signals and buffer memory names.
 Current value : Displays I/O signal status and current buffer memory values.
 Setting value : Select or input data to be written by test operation.

(2) Command buttons

Current value display	Displays the current value of the selected item. (This button is used to check characters that cannot be displayed in the "Current value" field. In this utility package, all characters can be displayed in this field, though.)
Make text file	Writes data displayed in the window to a file in text file format.
Start monitor	Select whether to monitor data in the "Current value" field.
Stop monitor	
Execute test	Tests the selected item. To select multiple items, select items while pressing the Ctrl key.
Close	Closes the open window and returns to the previous window.

Remark

The following explains a test operation ("Execute test") using an example where the count averaging of CH1 Sampling processing is changed to 10 and the setting is validated.

- (1) Click the CH1 Operating condition setting button in the Monitor/Test window.
- (2) Set the "Setting value" field of "CH1 Averaging process method setting" to "Count averaging".
- (3) Click the "Setting value" field of "CH1 Averaging process (time/number of times) setting".
- (4) Input "10" as the average number of processing times and press the Enter key.
At this point, the setting data have not been written to the Q64AD2DA.
- (5) Select the "Setting value" fields input in the operations (2) to (4) while pressing the Ctrl key. Multiple fields can be selected by dragging the mouse over them.
- (6) Click the Execute test button to write the data.
After the writing is completed, the written values are displayed in the "Current value" field.
Up to here, the Q64AD2DA has been operated with the setting before configuring settings of (2) to (4).
- (7) Set the "Setting value" field of "Operating condition setting request" to "Setting request".
- (8) Click the Execute test button while the "Setting value" field of "Operating condition setting request" is selected to validate the setting.

8.7 FB Conversion of Initial Setting/Auto Refresh

[Purpose]

Convert automatically an intelligent function module parameter (initial setting/auto refresh setting) into an FB.

[Operating procedure]

Window for selecting a target intelligent function module → Select the "FB Support Parameter" tab. → Click the **FB conversion** button.

[Setting dialog box]

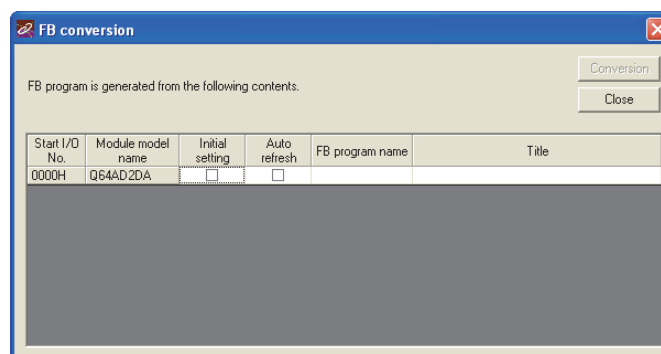

Figure 8.10 "FB conversion" dialog box

[Description]

(1) Display items

- Start I/O No.** : Displays the start I/O number set to the open intelligent function module parameter.
- Module model name** : Displays the module model name set to the open intelligent function module parameter.
- Initial setting** : Set whether to convert a parameter into an FB.
Select the checkbox to convert the parameter into an FB.
- Auto refresh** : Set whether to convert a parameter into an FB.
Select the checkbox to convert the parameter into an FB.
- FB program name** : Set the name of converted FB program.
Up to six characters can be set as an FB program name.
The following characters/words cannot be used for an FB program name.
Character: \, /, :, ;, *, ?
Word :COM1 to COM9, LPT1 to LPT9, AUX, PRN, CON, NUL, CLOCK\$
When an FB is registered with GX Developer, I- and A- are prefixed to the FB names of the initial setting and auto refresh setting, respectively.
- Title** : Set a title to a converted FB program.
Up to 32 characters can be set as a title.

(2) Command button

Conversion

Converts a selected parameter (initial setting/auto refresh setting) into an FB.

8.8 Usage of FB

This section explains procedures for using an FB with GX Developer.
For details, refer to the "GX Developer Version 8 Operating Manual (Function Block)".

8.8.1 Overview

The following shows procedures for creating an FB.

- 1) Set an intelligent function module parameter (initial setting/auto refresh setting).
- 2) Convert the intelligent function module parameter into an FB.
- 3) Paste the FB to a sequence program.
- 4) Convert (compile) the sequence program.

The following flowchart shows the flow of the above procedures 1) to 4).

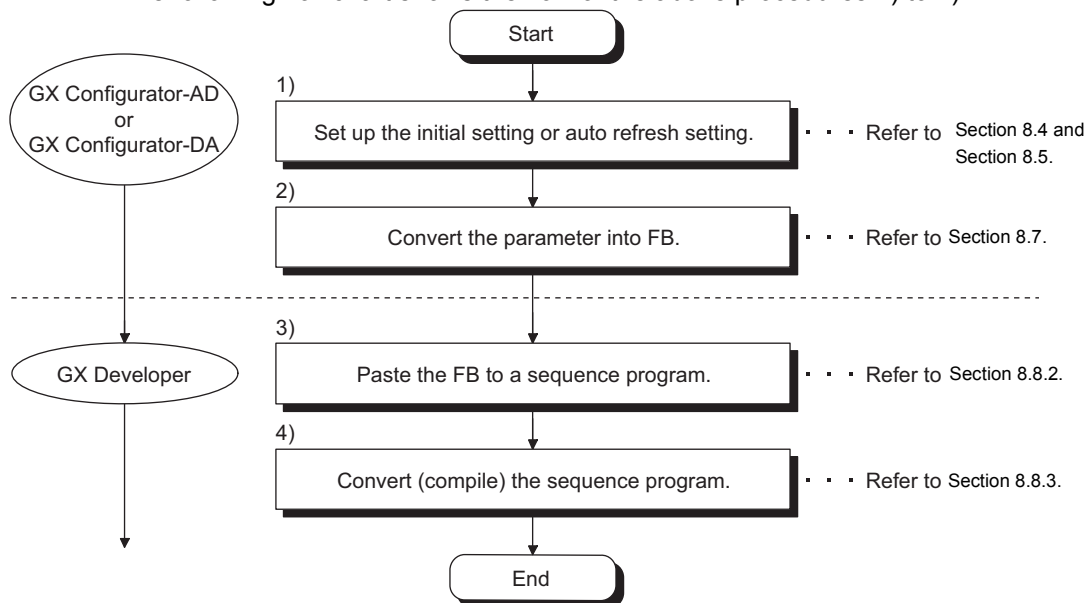

Figure 8.11 FB creation procedure

POINT

The initial setting/auto refresh setting of the intelligent function module can be configured by either of the following methods.

- (1) Set an intelligent function module parameter (initial setting/auto refresh setting) and write it to the CPU module.
- (2) Create an FB of the intelligent function module parameter (initial setting/auto refresh setting) and paste it to the sequence program.

According to the system specifications, configure the initial setting/auto refresh setting of the intelligent function module by either of the above methods.*1

* 1 The following explains when both (1) and (2) settings are configured.

- (a) Initial setting
Setting of (2) will be valid.
- (b) Auto refresh setting
 - Both (1) and (2) settings will be valid.
 - Auto refresh is performed at execution of an FB and END processing of the sequence program.

8.8.2 Pasting an FB to a sequence program

[Purpose]

Paste an FB to use it in a sequence program.

[Operating procedure]

Switch the "Project" tab to the "FB" tab in GX Developer, and drag and drop an FB on the sequence program.

Before pasting

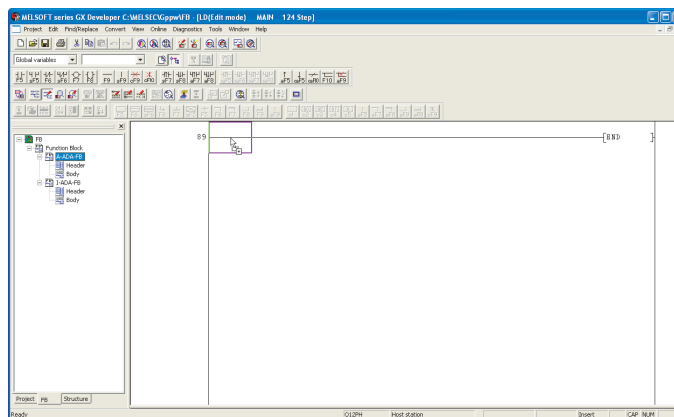

After pasting

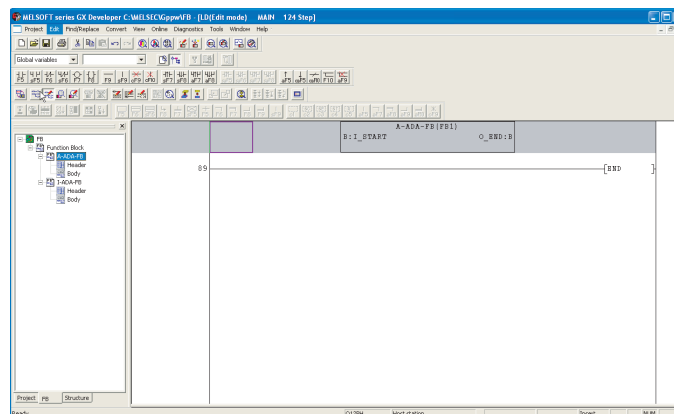

Figure 8.12 FB pasting procedure

8.8.3 Converting (compiling) a sequence program

[Purpose]

Convert (compile) a sequence program to which an FB was pasted so that the program can be executed.

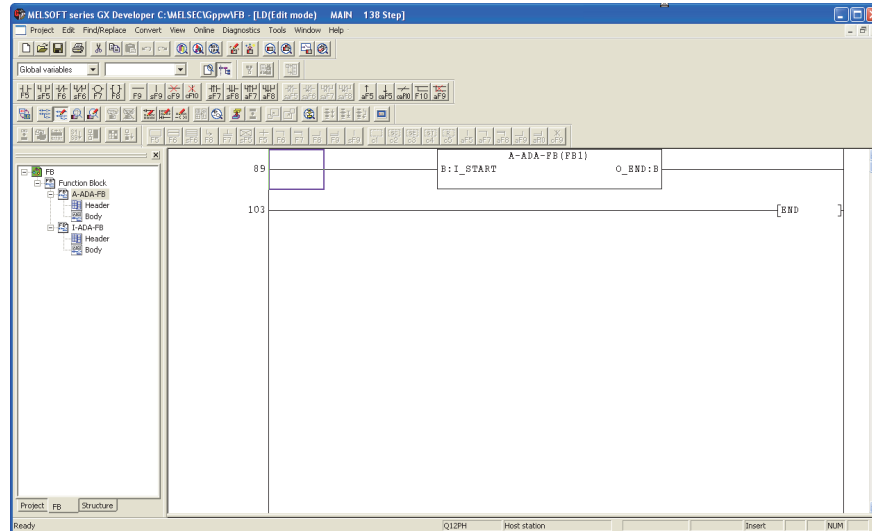

Figure 8.13 Conversion (compilation)

[Operating procedure]

Select [Convert] → [Convert/Compile] of GX Developer.

CHAPTER9 PROGRAMMING

This chapter explains programs of the Q64AD2DA.

When applying the programs introduced in this chapter to an actual system, fully verify that the system control has no problems.

Create a program in which A/D conversion or D/A conversion is performed with following the procedures shown in Figure 9.1.

The initial setting can be configured with both the utility package and sequence program. Using the utility package allows omitting an initial setting program and therefore the scan time will be shorten.

The program examples in this chapter explain the initial setting, auto refresh setting, and monitor/test operations with GX Configurator-AD. The same applies to GX Configurator-DA.

9.1 Programming Procedures

Create a program in which A/D conversion or D/A conversion is performed with following the procedures shown below.

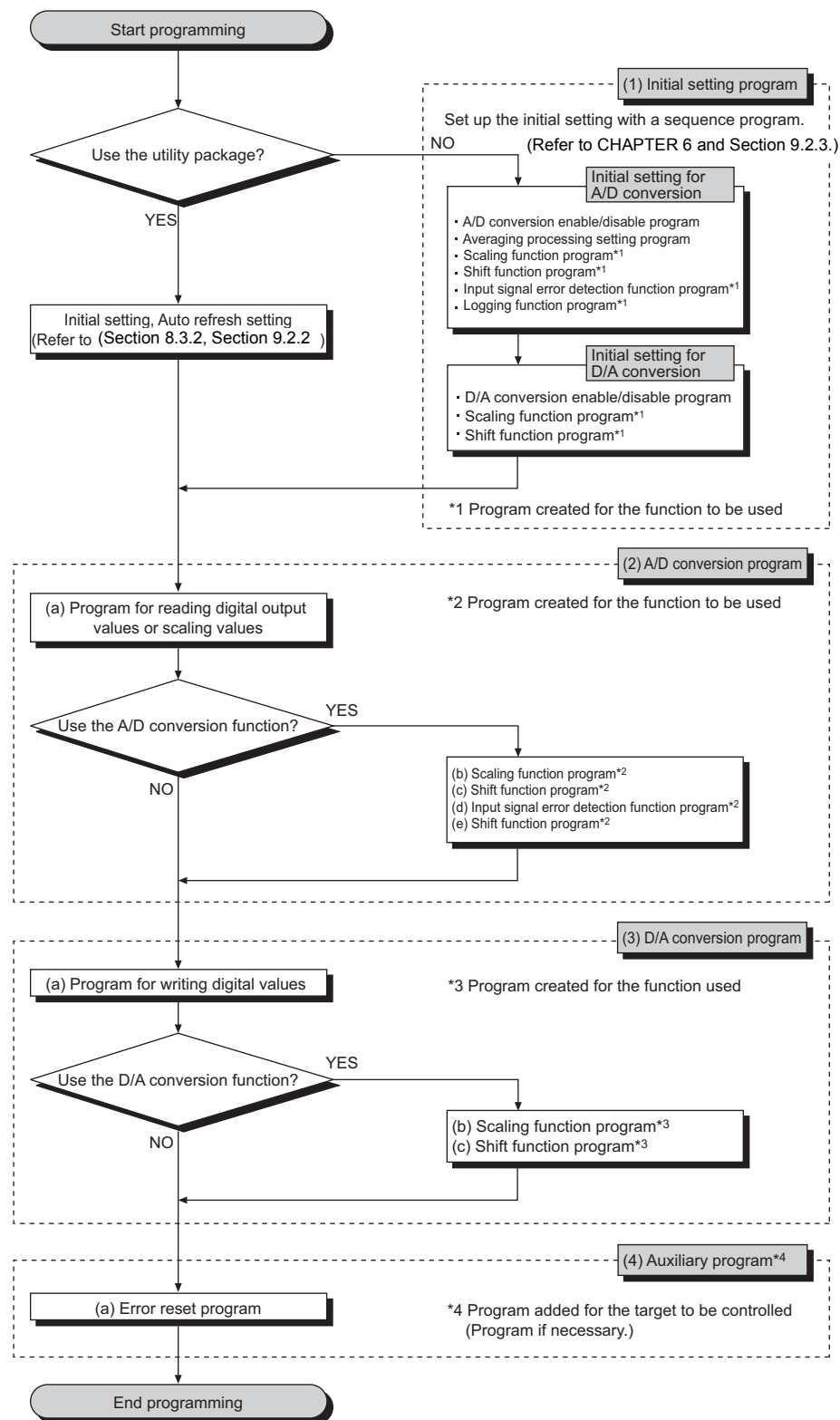

Figure 9.1 Programming flowchart

(1) Overview of the program examples

The following processing is separately explained in the program examples.

- (a) Initial setting program of the Q64AD2DA
- (b) A/D conversion program
 - 1) CH1 to CH3 Reading of a scaling value
 - 2) CH3 Processing when an input signal detects an error
- (c) D/A conversion program
 - 1) CH5 and CH6 Initial setting of a digital input value
 - 2) CH5 and CH6 Writing of a digital input value
 - 3) CH5 and CH6 Analog output enable
- (d) Output of an error code to an output module in BCD

9.2 Programming for Normal System Configuration

This section explains program examples using the following system configuration and conditions.

(1) System configuration

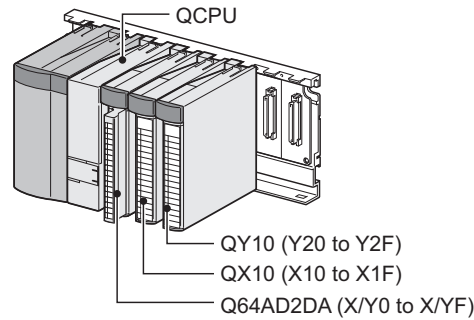

Figure 9.2 System configuration example

(2) Conditions of the intelligent function module switch setting

(a) A/D conversion

Table 9.1 Conditions of the intelligent function module switch setting

Channel	Input range setting	Resolution setting
CH1	4 to 20mA	High resolution mode
CH2	4 to 20mA (Extended mode)	
CH3	1 to 5V	
CH4	Not used	-

(b) D/A conversion

Table 9.2 Conditions of the intelligent function module switch setting

Channel	Output range setting	Setting of the analog output HOLD/CLEAR function	Resolution setting
CH5	4 to 20mA	CLEAR	High resolution mode
CH6	1 to 5V	HOLD	

(3) Programming conditions

(a) Used channels

A/D conversion: CH1 to CH3

D/A conversion: CH5 and CH6

(CH4 is not used in the program examples.)

(b) Use the following A/D conversion methods for each channel.

- CH1: Sampling processing
- CH2: Count average (50 times)
- CH3: Moving average (10 times)

(c) Use the following functions for each channel.

- CH2: Scaling function (A/D conversion)
 - CH2 A/D conversion scaling lower limit value: 1000
 - CH2 A/D conversion scaling upper limit value: 5000
- CH3: Input signal error detection function
 - CH3 Input signal error detection setting: Upper and lower detection
 - CH3 Input signal error detection setting value: 100 (10%)
- CH6: Scaling function (D/A conversion)
 - CH6 D/A conversion scaling lower limit value: 1000
 - CH6 D/A conversion scaling upper limit value: 5000

(d) When a write error occurs, the corresponding error code is output to an output module in BCD.

9.2.1 Before program creation

This section explains works required before program creation.

(1) Wiring of external devices (Refer to Section 7.4.2.)

Mount the Q64AD2DA on a base unit and wire external devices to the following channels.

Table 9.3 Channels to which external devices are wired

External device		Wiring channel
Input	Current	CH1 and CH2
	Voltage	CH3
Output	Current	CH5
	Voltage	CH6

[Wiring diagram]

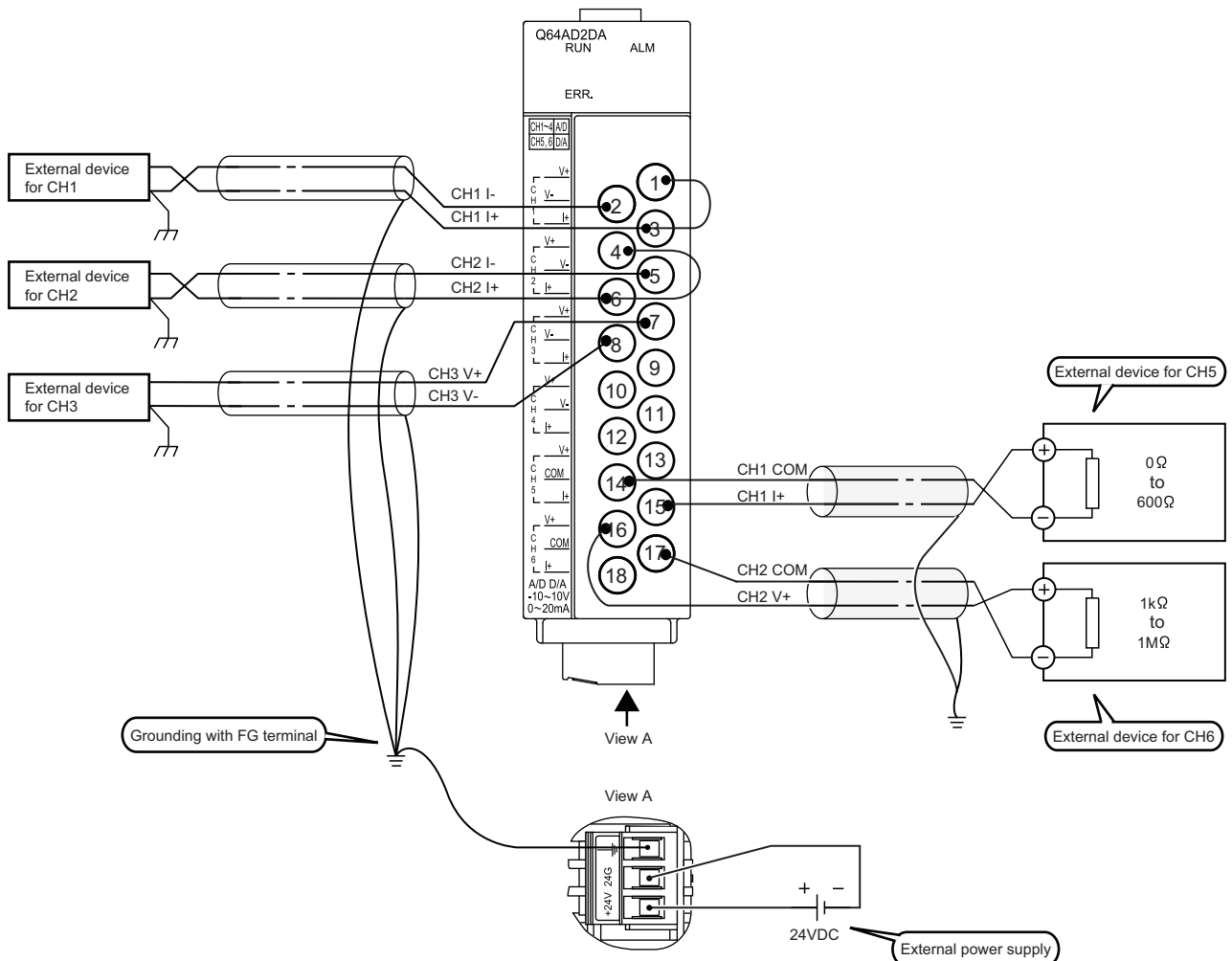

Figure 9.3 Wiring example for the program examples

(2) Intelligent function module switch setting (Refer to Section 7.5.2.)

Based on the setting conditions given in Section 9.2 (2), configure the intelligent function module switch setting.

(a) Switch settings**1) Switch 1: Input range setting (CH1 to CH4)**

Figure 9.4 Intelligent function module switch setting: Input range setting (CH1 to CH4)

2) Switch 2: Output range setting (CH5 and CH6)

Figure 9.5 Intelligent function module switch setting: Output range setting (CH5 and CH6)

3) Switch 3: Setting of the analog output HOLD/CLEAR function (CH5 and CH6)

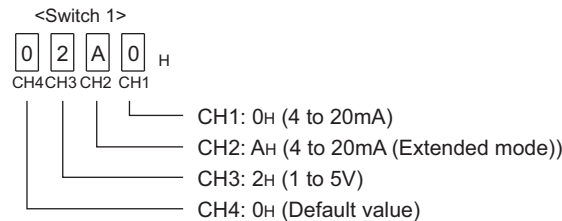
Figure 9.6 Intelligent function module switch setting: Setting of the analog output HOLD/CLEAR function (CH5 and CH6)

4) Switch 4: Resolution setting

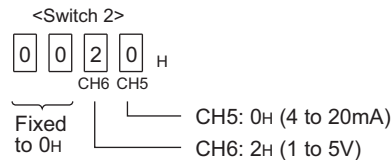
Figure 9.7 Intelligent function module switch setting: Resolution setting

5) Switch 5: Use prohibited (Fixed to 0H.)

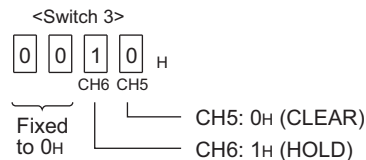
Figure 9.8 Intelligent function module switch setting: Use prohibited

(b) Switch setting for function module

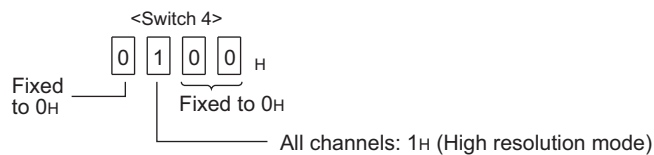
Click on **Switch setting** button in the "I/O assignment" tab of the parameter setting dialog box of GX Developer to display the dialog box shown below, then set switches 1 to 5.

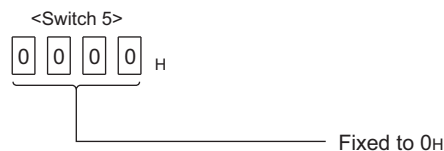
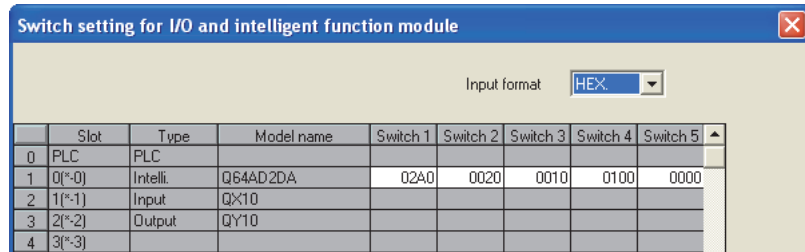

Figure 9.9 Intelligent function module switch setting with GX Developer

9.2.2 Program example using the utility package

(1) Device list

Table 9.4 Device list

Device	Function	
D1	Device to which CH1 Scaling value is written by auto refresh	
D2	Device to which CH2 Scaling value is written by auto refresh	
D3	Device to which CH3 Scaling value is written by auto refresh	
D4	Device to which CH1 A/D conversion completed flag is written by auto refresh	
D5	Device to which CH2 A/D conversion completed flag is written by auto refresh	
D6	Device to which CH3 A/D conversion completed flag is written by auto refresh	
D7	Device to which CH3 Input signal error detection flag is written by auto refresh	
D11	Device to which CH5 Digital input value is written by auto refresh	
D12	Device to which CH6 Digital input value is written by auto refresh	
D13	Device to which CH1 Error code is written by auto refresh	
D14	Device to which CH2 Error code is written by auto refresh	
D15	Device to which CH3 Error code is written by auto refresh	
D16	Device to which CH4 Error code is written by auto refresh	
D17	Device to which CH5 Error code is written by auto refresh	
D18	Device to which CH6 Error code is written by auto refresh	
D19	Device to which a common error code is written by auto refresh	
D20	Representation error	
D21	CH1 Scaling read value	
D22	CH2 Scaling read value	
D23	CH3 Scaling read value	
D31	CH5 Initial digital input value	
D32	CH6 Initial digital input value	
X0	Module ready	Q64AD2DA (X/Y0 to X/YF)
X7	Input signal error detection signal	
XF	Error flag	
Y5	CH5 Output enable/disable flag	
Y6	CH6 Output enable/disable flag	
Y9	Operating condition setting request	
YF	Error clear request	
X10	Device turned on by user to start reading a scaling value	
X11	Device turned on by user to set initial digital input value	
X12	Device turned on by user to write digital input value	
X13	Device turned on by user to enable analog outputs of all channels	
X14	Device turned on by user to reset input signal error detection	
X15	Device turned on by user to reset an error	
Y20 to Y2F	Error code display (4 digits in BCD)	QY10 (Y20 to Y2F)

(2) Utility package operation

(a) Initial setting (Refer to Section 8.4.)

Set the items shaded in the table below to the initial settings of CH1 to CH3, CH5, and CH6.

Setting for the items with "-" is not required when "Disable" has been set.

(The default value, which will be displayed in the "Setting value" field, needs not to be changed.)

Table 9.5 List of initial setting items (A/D conversion area)

Setting item	Default	CH1	CH2	CH3
A/D conversion enable/disable setting	Disable	Enable	Enable	Enable
Averaging process method setting	Sampling processing	Sampling processing	Count averaging	Move averaging
Averaging process (time/number of times) setting	0 (When Time averaging, Move averaging, or Count averaging is selected in Averaging process method setting: 4)	0	50	10
A/D conversion scaling enable/disable setting	Disable	Disable	Enable	Disable
A/D conversion scaling lower limit value	0	- Setting is not required since "Disable" is set. (The default value is displayed.)	1000	- Setting is not required since "Disable" is set. (The default value is displayed.)
A/D conversion scaling upper limit value	0	- Setting is not required since this item is not used. (The default value is displayed.)	5000	- Setting is not required since this item is not used. (The default value is displayed.)
Shifting amount to conversion value	0	- Setting is not required since this item is not used. (The default value is displayed.)	- Setting is not required since this item is not used. (The default value is displayed.)	- Setting is not required since this item is not used. (The default value is displayed.)
Input signal error detection setting	Disable	Disable	Disable	Upper and lower detection
Input signal error detection setting value	0	- Setting is not required since "Disable" is set. (The default value is displayed.)	- Setting is not required since "Disable" is set. (The default value is displayed.)	100
Logging enable/disable setting	Disable	Disable	Disable	Disable
Logging cycle unit setting	μs			
Logging cycle setting value	3000			
Logging data setting	Scaling value			
Logging points after trigger	5000			
Level trigger condition setting	Disable	- Setting is not required since "Disable" is set. (The default value is displayed.)	- Setting is not required since "Disable" is set. (The default value is displayed.)	- Setting is not required since "Disable" is set. (The default value is displayed.)
Trigger data	CH1: 102 CH2: 302 CH3: 502 CH4: 702			
Trigger setting value	0			

Table 9.6 List of initial setting items (D/A conversion area)

Setting item	Default	CH5	CH6
D/A conversion enable/disable setting	Disable	Enable	Enable
D/A conversion scaling enable/disable setting	Disable	Disable	Enable
D/A conversion scaling lower limit value	0	- Setting is not required since "Disable" is set. (The default value is displayed.)	1000
D/A conversion scaling upper limit value	0	- Setting is not required since "Disable" is set. (The default value is displayed.)	5000
Shifting amount to input value	0	- Setting is not required since this item is not used. (The default value is displayed.)	- Setting is not required since this item is not used. (The default value is displayed.)

- 1) Click the Initial setting button of setting target channel.
In the program example, set CH1 to CH3, CH5, and CH6.
Setting of CH4 is not required since CH4 is not used.

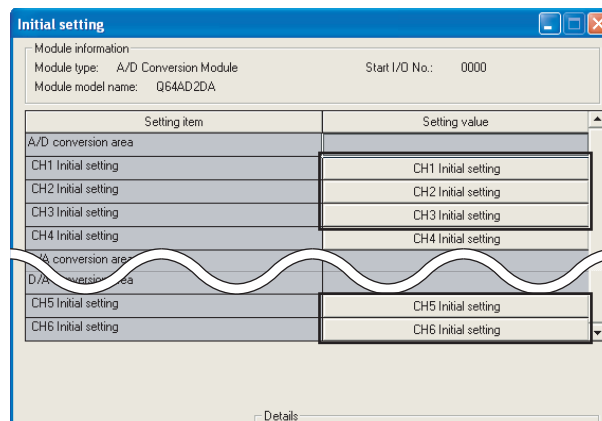

Figure 9.10 "Initial setting" window

- 2) Clicking the Initial setting button of each channel opens a window as shown below.
 Set the initial setting items listed in Table 9.5 and Table 9.6 in the window.
 The following is the example windows of "CH1 Initial setting" and "CH5 Initial setting".

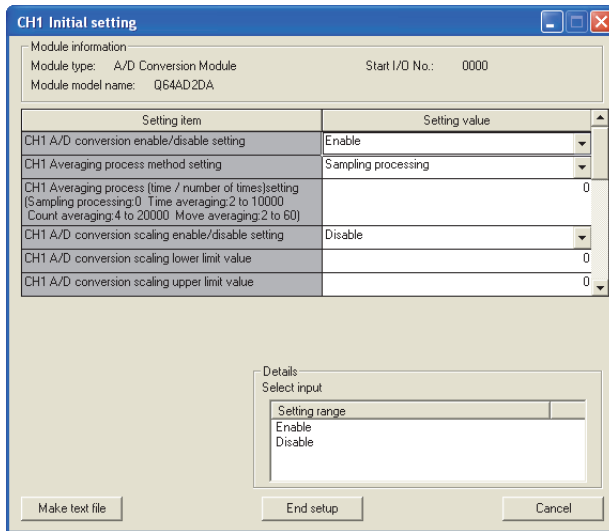

Figure 9.11 "CH1 Initial setting" (A/D conversion area) window

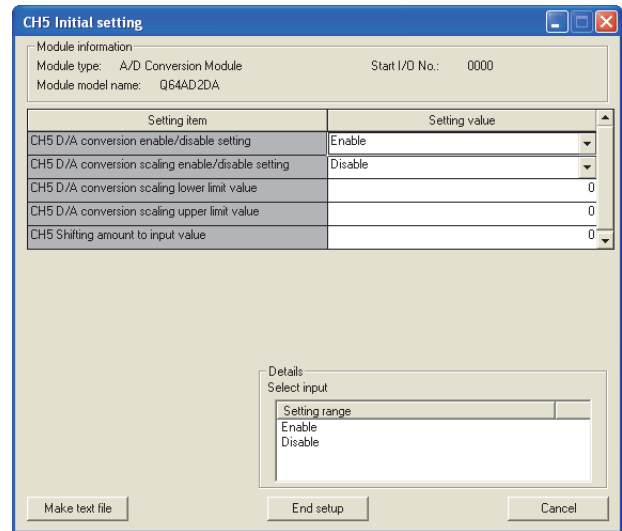

Figure 9.12 "CH5 Initial setting" (D/A conversion area) window

(b) Auto refresh setting

Set devices storing the following buffer memory data to each item.

- 1) A/D conversion area
 - Shifting amount to conversion value
 - Digital output value
 - Scaling value
 - Maximum/minimum digital output values
 - Maximum/minimum scaling values
 - A/D conversion completed flag
 - Input signal error detection flag
- 2) D/A conversion area
 - Digital input value
 - Shifting amount to input value
 - Set value check code
 - Real conversion digital value
- 3) Common area
 - Error code
 - Common error code
 - Level data 0 to 9

For operations of the utility package, refer to Section 8.5.

For setting of "PLC side Device" in the "Auto refresh setting" window, refer to the assignment shown in (1) in this section Device list.

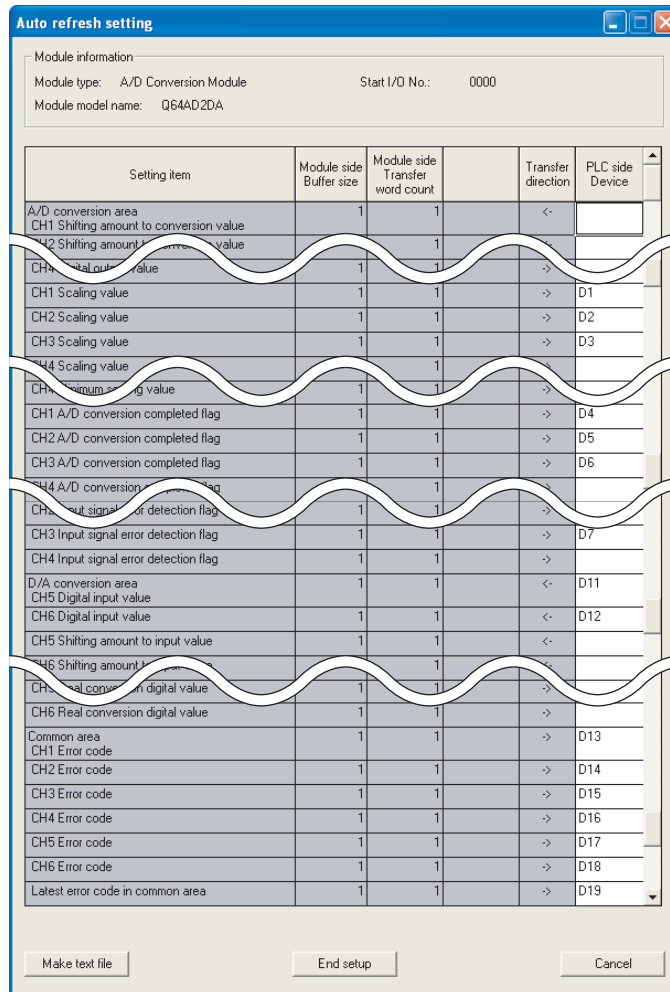

Figure 9.13 "Auto refresh setting" screen

- (c) Writing intelligent function module parameters (Refer to Section 8.3.3.)
 Write the intelligent function module parameters to the CPU module.
 Configure the setting in the window for selecting a target intelligent function module.

(3) Program example

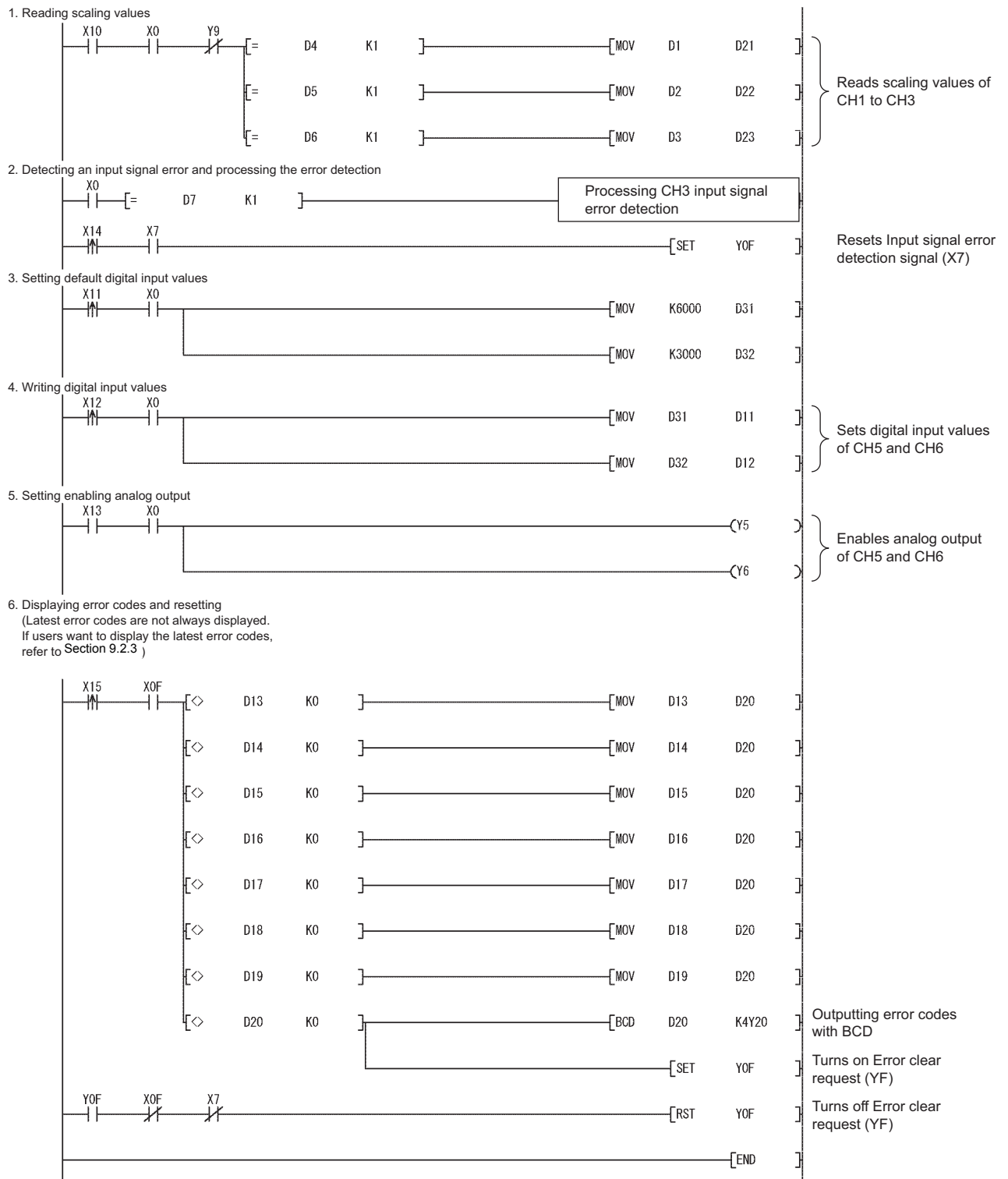

Figure 9.14 Program example using GX Configurator-AD

9.2.3 Program example without using the utility package

(1) Device list

Table 9.7 Device list

Device	Function	
D21	CH1 Scaling read value	
D22	CH2 Scaling read value	
D23	CH3 Scaling read value	
D31	CH5 Initial digital input value	
D32	CH6 Initial digital input value	
Z0	Device used for obtaining the latest address of error history	
X0	Module ready	Q64AD2DA (X/Y0 to X/YF)
X7	Input signal error detection signal	
X9	Operating condition setting completion flag	
XF	Error flag	
Y5	CH5 Output enable/disable flag	
Y6	CH6 Output enable/disable flag	
Y9	Operating condition setting request	
YF	Error clear request	
X10	Device turned on by user to start reading a scaling value	QX10 (X10 to X1F)
X11	Device turned on by user to set initial digital input value	
X12	Device turned on by user to write digital input value	
X13	Device turned on by user to enable analog outputs of all channels	
X14	Device turned on by user to reset input signal error detection	
X15	Device turned on by user to reset an error	
Y20 to Y2F	Error code display (4 digits in BCD)	QY10 (Y20 to Y2F)

(2) List of used buffer memory addresses

Table 9.8 List of used buffer memory addresses

Address	Description	Setting value	Remarks
Un\G0	CH1 A/D conversion enable/disable setting	0	Enable CH1.
Un\G102	CH1 Scaling value	-	Measured CH1 Scaling value is stored.
Un\G113	CH1 A/D conversion completed flag	-	Completion status of the first A/D conversion of CH1 is stored.
Un\G200	CH2 A/D conversion enable/disable setting	0	Enable CH2.
Un\G201	CH2 Averaging process method setting	2	Set the process method. CH2: Count average
Un\G202	CH2 Averaging process (time/number of times) setting	50	Set the average number of processes (times) when count average has been set.
Un\G210	CH2 A/D conversion scaling enable/disable setting	0	Set these items to use CH2 Scaling function.
Un\G211	CH2 A/D conversion scaling lower limit value	1000	
Un\G212	CH2 A/D conversion scaling upper limit value	5000	
Un\G302	CH2 Scaling value	-	Measured CH2 Scaling value is stored.
Un\G313	CH2 A/D conversion completed flag	-	Completion status of the first A/D conversion of CH2 is stored.
Un\G400	CH3 A/D conversion enable/disable setting	0	Enable CH3.
Un\G401	CH3 Averaging process method setting	3	Set the process method. CH3: Moving average
Un\G402	CH3 Averaging process (time/number of times) setting	10	Set the average number of moves (times) when moving average has been set.
Un\G420	CH3 Input signal error detection setting	1	Set these items to use CH3 Error detection.
Un\G421	CH3 Input signal error detection setting value	100	Error detection method: Upper and lower detection Error detection setting range: 10%
Un\G502	CH3 Scaling value	-	Measured CH3 Scaling value is stored.
Un\G513	CH3 A/D conversion completed flag	-	Completion status of the first A/D conversion of CH3 is stored.
Un\G514	CH3 Input signal error detection flag	-	CH3 Error detection status is stored.
Un\G800	CH5 D/A conversion enable/disable setting	0	Enable CH5.
Un\G802	CH5 Digital input value	-	Measured CH5 Digital input value is stored.
Un\G1000	CH6 D/A conversion enable/disable setting	0	Enable CH6.
Un\G1002	CH6 Digital input value	-	Measured CH6 Digital input value is stored.
Un\G1010	CH6 D/A conversion scaling enable/disable setting	0	Set these items to use CH6 Scaling function.
Un\G1011	CH6 D/A conversion scaling lower limit value	1000	
Un\G1012	CH6 D/A conversion scaling upper limit value	5000	
Un\G1800	Latest address of error history	-	The buffer memory address storing the latest error code is stored.
Un\G1810 to Un\G1960	Error history 1 to Error history 16	-	The error code of the current error is stored.

(3) Program example

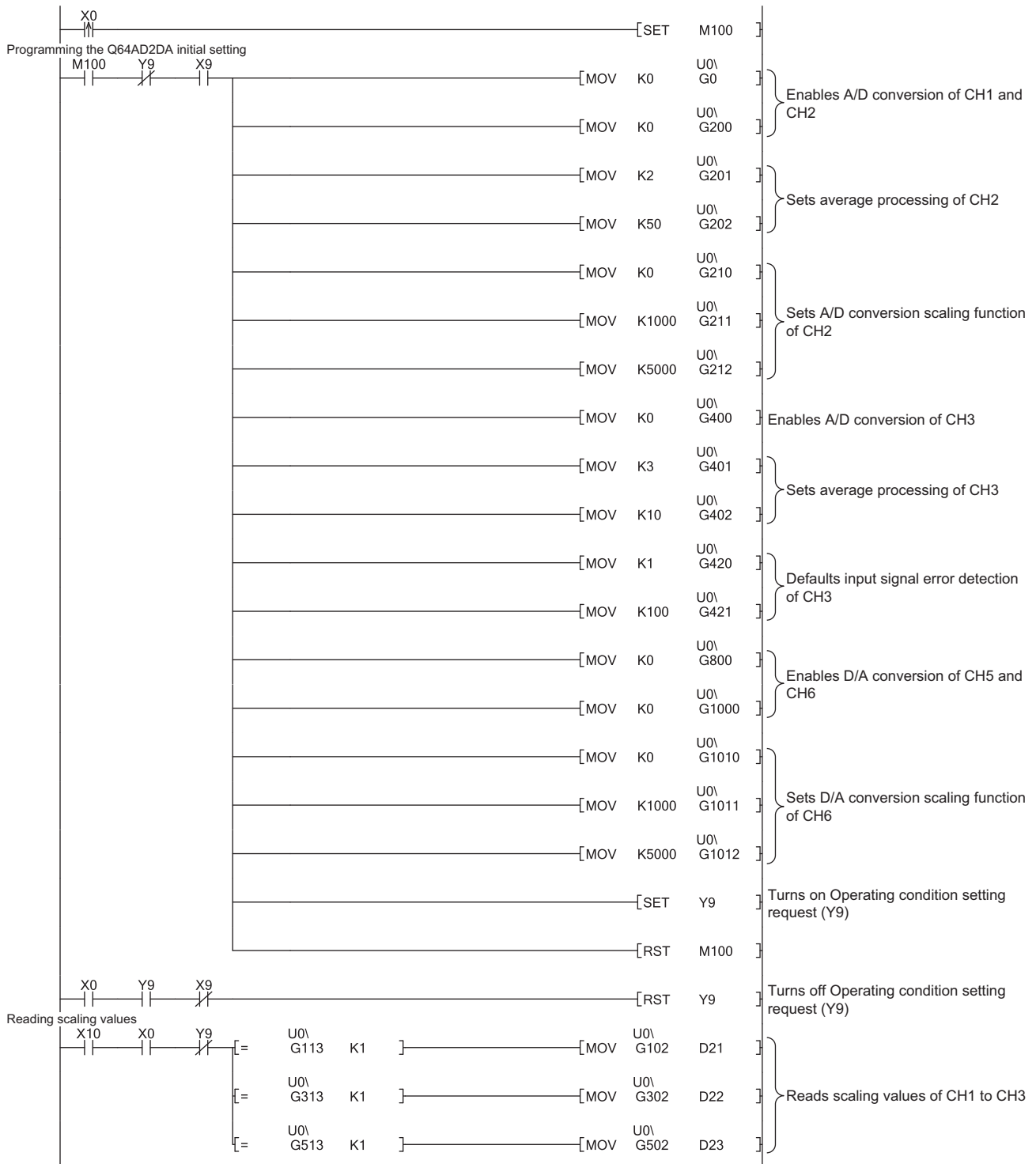

Figure 9.15 Program example without using GX Configurator-AD

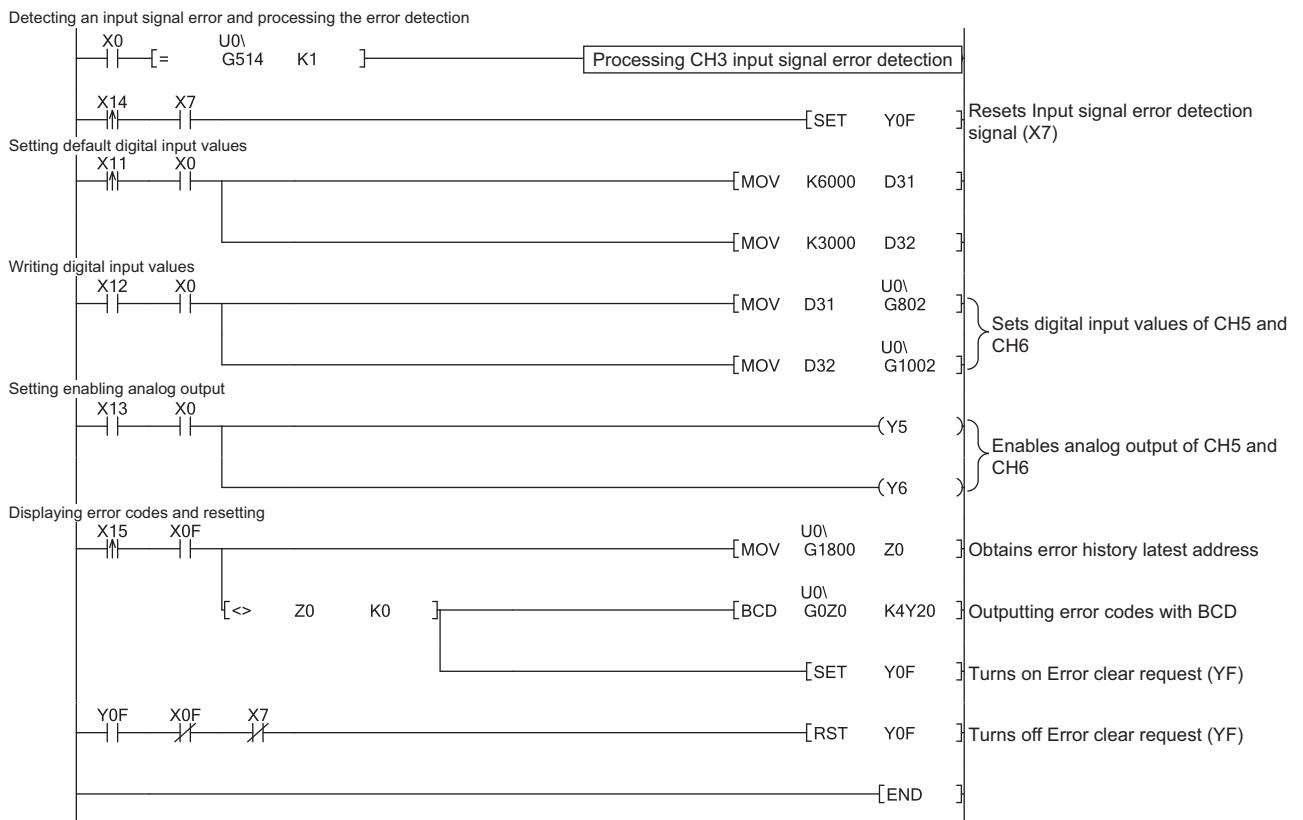

Figure 9.15 Program example without using GX Configurator-AD (continued)

9.3 Programming for Remote I/O Network

This section explains program examples using the following system configuration and conditions.

(1) System configuration

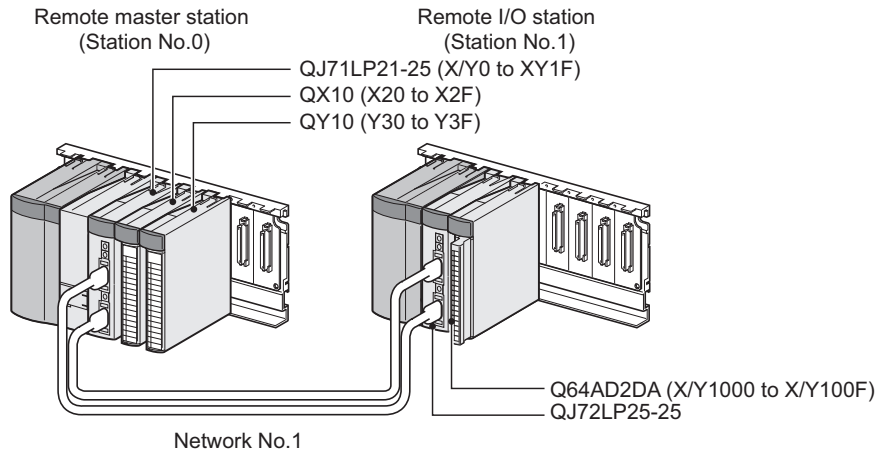

Figure 9.16 System configuration example

(2) Conditions of the intelligent function module switch setting

(a) A/D conversion

Table 9.9 Conditions of the intelligent function module switch setting

Channel	Input range setting	Resolution setting
CH1	4 to 20mA	High resolution mode
CH2	4 to 20mA (Extended mode)	
CH3	1 to 5V	
CH4	Not used	-

(b) D/A conversion

Table 9.10 Conditions of the intelligent function module switch setting

Channel	Output range setting	Setting of the analog output HOLD/CLEAR function	Resolution setting
CH5	4 to 20mA	CLEAR	High resolution mode
CH6	1 to 5V	HOLD	

(3) Programming conditions

(a) Used channels

A/D conversion: CH1 to CH3

D/A conversion: CH5 and CH6

(CH4 is not used in the program examples.)

(b) Use the following A/D conversion methods for each channel.

- CH1: Sampling processing
- CH2: Count average (50 times)
- CH3: Moving average (10 times)

(c) Use the following functions for each channel.

- CH2: Scaling function (A/D conversion)
 - CH2 A/D conversion scaling lower limit value: 1000
 - CH2 A/D conversion scaling upper limit value: 5000
- CH3: Input signal error detection function
 - CH3 Input signal error detection setting: Upper and lower detection
 - CH3 Input signal error detection setting value: 100 (10%)
- CH6: Scaling function (D/A conversion)
 - CH6 D/A conversion scaling lower limit value: 1000
 - CH6 D/A conversion scaling upper limit value: 5000

(d) When a write error occurs, the corresponding error code is output to an output module in BCD.

9.3.1 Before program creation

This section explains works required before program creation.

(1) Wiring of external devices

Mount the Q64AD2DA on a base unit and wire external devices to CH1 to CH3, CH5, and CH6.

For wiring method, refer to Section 9.2.1 (1).

(2) Intelligent function module switch setting

Based on the setting conditions given in Section 9.3 (2), configure the intelligent function module switch setting.

For details, refer to Section 9.2.1 (2).

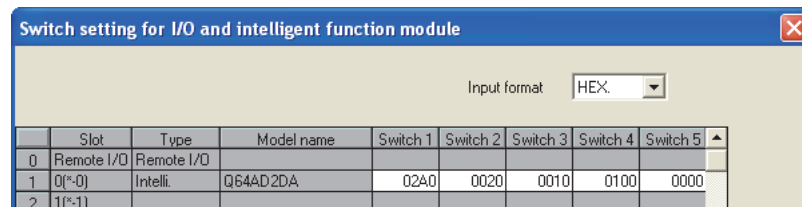

Figure 9.17 Intelligent function module switch setting with GX Developer

Write the intelligent function module parameters to the remote I/O station.

POINT

For details of the MELSECNET/H remote I/O network, refer to the Q Corresponding MELSECNET/H Network System Reference Manual (Remote I/O network).

9.3.2 Program example using the utility package

(1) Device list

Table 9.11 Device list

Device	Function	
W1	Device to which CH1 Scaling value is written by auto refresh	
W2	Device to which CH2 Scaling value is written by auto refresh	
W3	Device to which CH3 Scaling value is written by auto refresh	
W4	Device to which CH1 A/D conversion completed flag is written by auto refresh	
W5	Device to which CH2 A/D conversion completed flag is written by auto refresh	
W6	Device to which CH3 A/D conversion completed flag is written by auto refresh	
W7	Device to which CH3 Input signal error detection flag is written by auto refresh	
W8	Device to which CH1 Error code is written by auto refresh	
W9	Device to which CH2 Error code is written by auto refresh	
WA	Device to which CH3 Error code is written by auto refresh	
WB	Device to which CH4 Error code is written by auto refresh	
WC	Device to which CH5 Error code is written by auto refresh	
WD	Device to which CH6 Error code is written by auto refresh	
WE	Device to which a common error code is written by auto refresh	
W80	Device to which CH5 Digital input value is written by auto refresh	
W81	Device to which CH6 Digital input value is written by auto refresh	
D20	Representation error	
D21	CH1 Scaling read value	
D22	CH2 Scaling read value	
D23	CH3 Scaling read value	
D31	CH5 Initial digital input value	
D32	CH6 Initial digital input value	
X20	Device turned on by user to start reading a scaling value	QX10 (X20 to X2F)
X21	Device turned on by user to set initial digital input value	
X22	Device turned on by user to write digital input value	
X23	Device turned on by user to enable analog outputs of all channels	
X24	Device turned on by user to reset input signal error detection	
X25	Device turned on by user to reset an error	
Y30 to Y3F	Error code display (4 digits in BCD)	QY10 (Y30 to Y3F)
X1000	Module ready	Q64AD2DA (X/Y1000 to X/Y100F)
X1007	Input signal error detection signal	
X100F	Error flag	
Y1005	CH5 Output enable/disable flag	
Y1006	CH6 Output enable/disable flag	
Y1009	Operating condition setting request	
Y100F	Error clear request	

(2) GX Developer operation (setting of the network parameter)

- Network type : MNET/H (Remote master)
- Starting I/O No. : 0000H
- Network No. : 1
- Total stations : 1
- Mode : On line
- Network range assignment :

StationNo.	M station -> R station						M station <- R station					
	Y			Y			X			X		
	Points	Start	End	Points	Start	End	Points	Start	End	Points	Start	End
1	256	1000	10FF	256	0000	00FF	256	1000	10FF	256	0000	00FF

StationNo.	M station -> R station			M station <- R station			M station -> R station			M station <- R station		
	B			B			W			W		
	Points	Start	End	Points	Start	End	Points	Start	End	Points	Start	End
1							128	0080	00FF	128	0000	007F

Figure 9.18 "Network range assignment" screen

- Refresh parameters:

	Link side					PLC side			
	Dev. name	Points	Start	End		Dev. name	Points	Start	End
Transfer SB	SB	512	0000	01FF	↔	SB	512	0000	01FF
Transfer SW	SW	512	0000	01FF	↔	SW	512	0000	01FF
Random cyclic	LB				↔				
Random cyclic	LW				↔				
Transfer1	LB	8192	0000	1FFF	↔	B	8192	0000	1FFF
Transfer2	LW	8192	0000	1FFF	↔	W	8192	0000	1FFF
Transfer3	LX	256	1000	10FF	↔	X	256	1000	10FF
Transfer4	LY	256	1000	10FF	↔	Y	256	1000	10FF
Transfer5					↔				
Transfer6					↔				

Figure 9.19 "Refresh parameters" screen

(3) Utility package operation

Operate on the remote I/O station side.

(a) Initial setting (For operations of the utility package, refer to Section 8.4.)

Configure the initial settings of CH1 to CH3, CH5, and CH6.

For details, refer to Section 9.2.2 (2).

(b) Auto refresh setting (For operations of the utility package, refer to Section 8.5.)

Set devices storing the following buffer memory data to each item.

1) A/D conversion area

- Shifting amount to conversion value
- Digital output value
- Scaling value
- Maximum/minimum digital output values
- Maximum/minimum scaling values
- A/D conversion completed flag
- Input signal error detection flag

2) D/A conversion area

- Digital input value
- Shifting amount to input value
- Set value check code
- Real conversion digital value

3) Common area

- Error code
- Common error code
- Level data 0 to 9

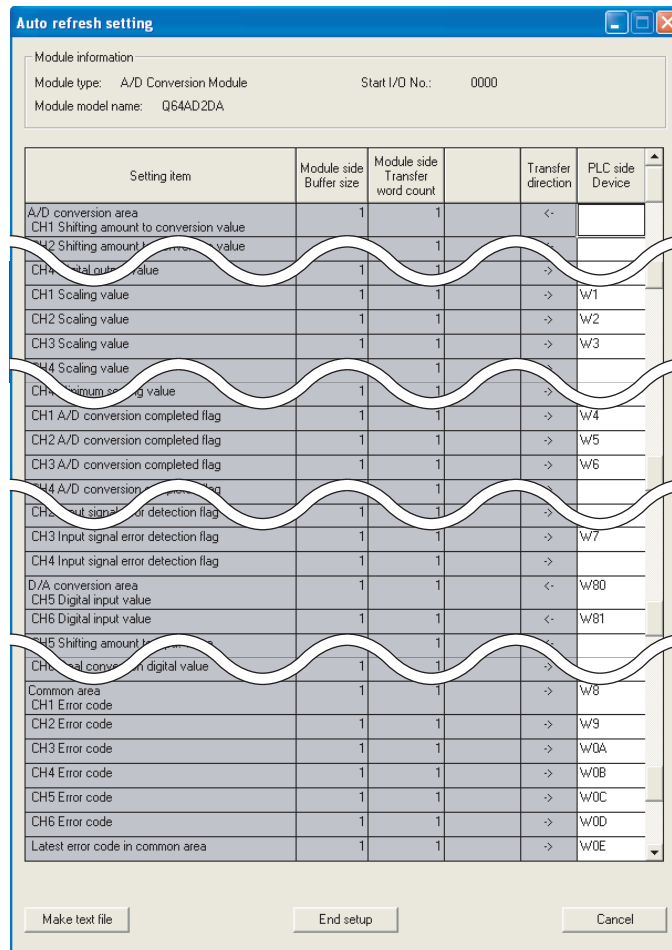

Figure 9.20 "Auto refresh setting" window

- (c) Writing intelligent function module parameters (Refer to Section 8.3.3.)
 Write the intelligent function module parameters to the remote I/O station.
 Configure the setting in the window for selecting a target intelligent function module.

POINT

To write the intelligent function module parameters, set a target remote I/O station in the screen opened by selecting [Online] → [Transfer setup] of GX Developer. The intelligent function module parameters can be written by:

- Directly connecting GX Developer to the remote I/O station.
- Routing the network to the remote I/O station by connecting GX Developer to a device such as a CPU module.

(4) Program example

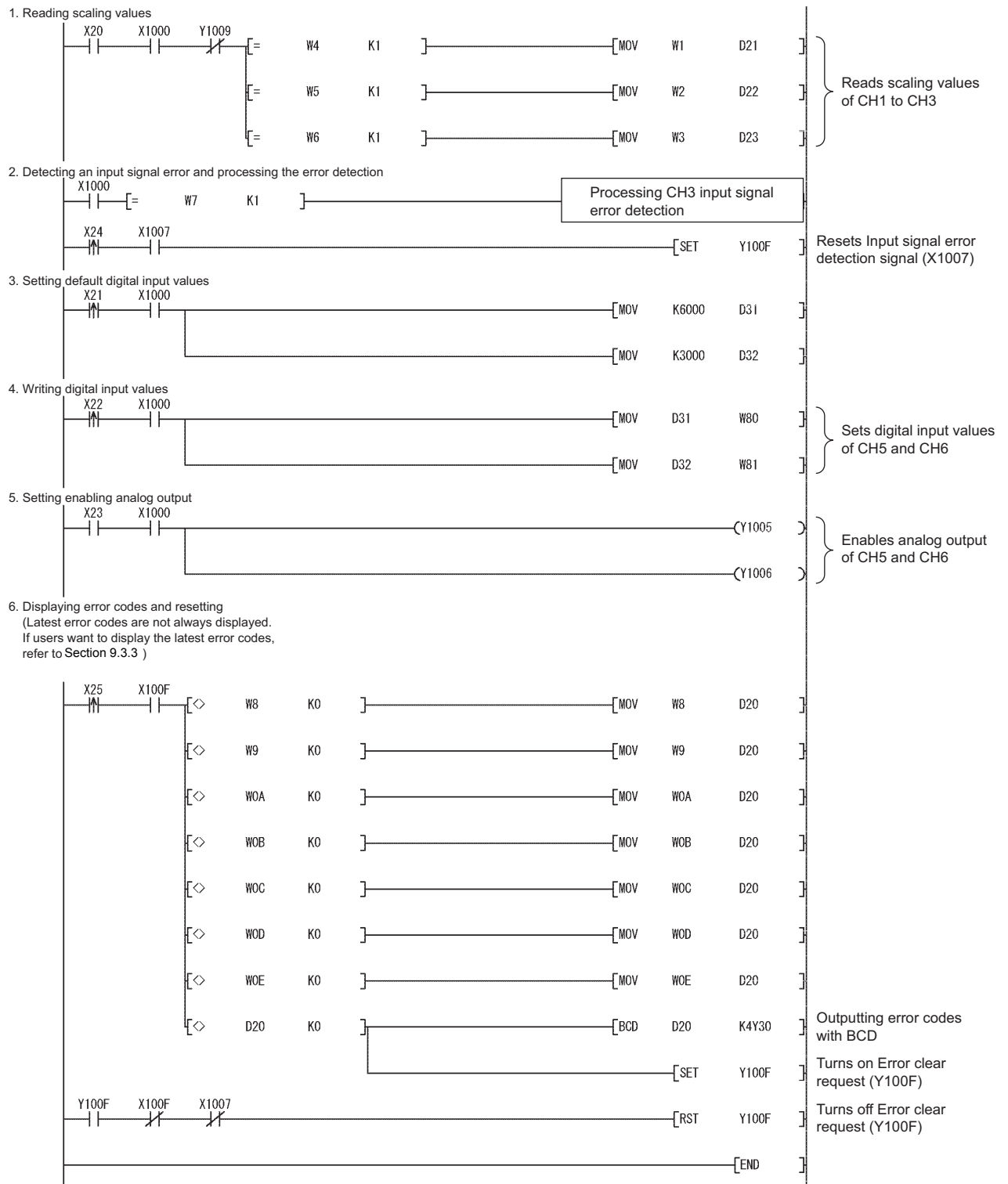

Figure 9.21 Program example using GX Configurator-AD

9.3.3 Program example without using the utility package

(1) Device list

Table 9.12 Device list

Device	Function	
D21	CH1 Scaling read value	
D22	CH2 Scaling read value	
D23	CH3 Scaling read value	
D31	CH5 Initial digital input value	
D32	CH6 Initial digital input value	
Z0	Device used for obtaining the latest address of error history	
X20	Device turned on by user to start reading a scaling value	QX10 (X20 to X2F)
X21	Device turned on by user to set initial digital input value	
X22	Device turned on by user to write digital input value	
X23	Device turned on by user to enable analog outputs of all channels	
X24	Device turned on by user to reset input signal error detection	
X25	Device turned on by user to reset an error	QY10 (Y30 to Y3F)
Y30 to Y3F	Error code display (4 digits in BCD)	
X1000	Module ready	Q64AD2DA (X/Y1000 to X/Y100F)
X1007	Input signal error detection signal	
X1009	Operating condition setting request	
X100F	Error flag	
Y1005	CH5 Output enable/disable flag	
Y1006	CH6 Output enable/disable flag	
Y1009	Operating condition setting request	
Y100F	Error clear request	
D1000	Device to which buffer memory data used in A/D conversion channels are written	
D1010 to D1015		
D1020 to D1022		
D1030, D1031		
D1040	Device to which buffer memory data used in D/A conversion channels are written	
D1050		
D1060 to D1062		
D2000 to D2599	Device to which buffer memory data used in A/D conversion channels are read	
D3000 to D3199	Device to which buffer memory error code area is read	

Table 9.12 Device list

Device	Function		
SB20	Network module status	Device for checking the master station status	
SB47	Host baton pass status		
SB49	Host data link status		
SW70	Baton pass status of each station		
SW74	Cyclic transmission status of each station		
SW78	Parameter communication status of each station		
T100	Timer for checking baton pass status of the master station		
T101	Timer for checking data link status of the master station		
T102	Timer for checking baton pass status of the remote I/O station		
T103	Timer for checking data link status of the remote I/O station		
T104	Timer for checking refresh status of the remote I/O station parameter		
M100	Master station status check flag		
M101	Initial setting start trigger		Device for write operation of the initial settings for the Q64AD2DA
M102	CH1 Initial setting start flag		
M103	Initial setting-in-process flag		
M104	Initial setting completion flag		
M200, M201	CH1 Initial setting transfer check flag		
M202	CH1 Initial setting completion flag		
M210, M211	CH2 Initial setting #1 transfer check flag		
M212	CH2 Initial setting #1 completion flag		
M220, M221	CH2 Initial setting #2 transfer check flag		
M222	CH2 Initial setting #2 completion flag		
M230, M231	CH3 Initial setting #1 transfer check flag		
M232	CH3 Initial setting #1 completion flag		
M240, M241	CH3 Initial setting #2 transfer check flag		
M242	CH3 Initial setting #2 completion flag		
M250, M251	CH5 Initial setting transfer check flag		
M252	CH5 Initial setting completion flag		
M260, M261	CH6 Initial setting #1 transfer check flag		
M262	CH6 Initial setting #1 completion flag		
M270, M271	CH6 Initial setting #2 transfer check flag		
M272	CH6 Initial setting #2 completion flag		
M280, M281	Buffer memory A/D conversion channel area transfer check flag	Device for write/read operations to the Q64AD2DA buffer memory	
M282	Buffer memory A/D conversion channel area read completion flag		
M290, M291	CH5 Digital input value transfer check flag		
M292	CH5 Digital input value write completion flag		
M300, M301	CH6 Digital input value transfer check flag		
M302	CH6 Digital input value write completion flag		
M310, M311	Buffer memory error code area transfer check flag		
M312	Buffer memory error code area read completion flag		

(2) List of used buffer memory addresses

The Z(P).REMFR or Z(P).REMTO instruction is used to access the buffer memory of the Q64AD2DA.

Check the access device in the "Address (device)" column in Table 9.13.

Table 9.13 List of used buffer memory addresses

Address (device)	Description	Setting value	Remarks
Un\G0 (D1000)	CH1 A/D conversion enable/disable setting	0	Enable CH1.
Un\G102 (D2102)	CH1 Scaling value	-	Measured CH1 Scaling value is stored.
Un\G113 (D2113)	CH1 A/D conversion completed flag	-	Completion status of the first A/D conversion of CH1 is stored.
Un\G200 (D1010)	CH2 A/D conversion enable/disable setting	0	Enable CH2.
Un\G201 (D1011)	CH2 Averaging process method setting	2	Set the process method. CH2: Count average
Un\G202 (D1012)	CH2 Averaging process (time/number of times) setting	50	Set the average number of processes (times) when count average has been set.
Un\G210 (D1013)	CH2 A/D conversion scaling enable/disable setting	0	Set these items to use CH2 Scaling function.
Un\G211 (D1014)	CH2 A/D conversion scaling lower limit value	1000	
Un\G212 (D1015)	CH2 A/D conversion scaling upper limit value	5000	
Un\G302 (D2302)	CH2 Scaling value	-	Measured CH2 Scaling value is stored.
Un\G313 (D2313)	CH2 A/D conversion completed flag	-	Completion status of the first A/D conversion of CH2 is stored.
Un\G400 (D1020)	CH3 A/D conversion enable/disable setting	0	Enable CH3.
Un\G401 (D1021)	CH3 Averaging process method setting	3	Set the process method. CH3: Moving average
Un\G402 (D1022)	CH3 Averaging process (time/number of times) setting	10	Set the average number of moves (times) when moving average has been set.
Un\G420 (D1030)	CH3 Input signal error detection setting	1	Set these items to use CH3 Error detection. Error detection method: Upper and lower detection Error detection setting range: 10%
Un\G421 (D1031)	CH3 Input signal error detection setting value	100	
Un\G502 (D2502)	CH3 Scaling value	-	Measured CH3 Scaling value is stored.
Un\G513 (D2513)	CH3 A/D conversion completed flag	-	Completion status of the first A/D conversion of CH3 is stored.
Un\G514 (D2514)	CH3 Input signal error detection flag	-	CH3 Error detection status is stored.
Un\G800 (D1040)	CH5 D/A conversion enable/disable setting	0	Enable CH5.

Table 9.13 List of used buffer memory addresses

Address (device)	Description	Setting value	Remarks
Un\G802 (D31)	CH5 Digital input value	-	Measured CH5 Digital input value is stored.
Un\G1000 (D1050)	CH6 D/A conversion enable/disable setting	0	Enable CH6.
Un\G1002 (D32)	CH6 Digital input value	-	Measured CH6 Digital input value is stored.
Un\G1010(D1060)	CH6 D/A conversion scaling enable/disable setting	0	Set these items to use CH6 Scaling function.
Un\G1011 (D1061)	CH6 D/A conversion scaling lower limit value	1000	
Un\G1012 (D1062)	CH6 D/A conversion scaling upper limit value	5000	
Un\G1800 (D3000)	Latest address of error history	-	The buffer memory address storing the latest error code is stored.
Un\G1810 (D3010)	Error history 1	-	The error code of the current error is stored.
to	to		
Un\G1960 (D3160)	Error history 16		

(3) GX Developer operation (setting of the network parameter)

- Network type : MNET/H (Remote master)
- Starting I/O No. : 0000H
- Network No. : 1
- Total stations : 1
- Mode : On line
- Network range assignment :

StationNo.	M station -> R station						M station <- R station					
	Y			Y			X			X		
	Points	Start	End	Points	Start	End	Points	Start	End	Points	Start	End
1	256	1000	10FF	256	0000	00FF	256	1000	10FF	256	0000	00FF

StationNo.	M station -> R station			M station <- R station			M station -> R station			M station <- R station		
	B			B			W			W		
	Points	Start	End	Points	Start	End	Points	Start	End	Points	Start	End
1							160	0000	009F			

Figure 9.22 "Network range assignment" screen

- Refresh parameters:

	Link side					PLC side			
	Dev. name	Points	Start	End		Dev. name	Points	Start	End
Transfer SB	SB	512	0000	01FF	↔	SB	512	0000	01FF
Transfer SW	SW	512	0000	01FF	↔	SW	512	0000	01FF
Random cyclic	LB				↔				
Random cyclic	LW				↔				
Transfer1	LB	8192	0000	1FFF	↔	B	8192	0000	1FFF
Transfer2	LW	8192	0000	1FFF	↔	W	8192	0000	1FFF
Transfer3	LX	256	1000	10FF	↔	X	256	1000	10FF
Transfer4	LY	256	1000	10FF	↔	Y	256	1000	10FF
Transfer5					↔				
Transfer6					↔				

Figure 9.23 "Refresh parameter" screen

(4) Program example

1. Checking remote I/O station operation status

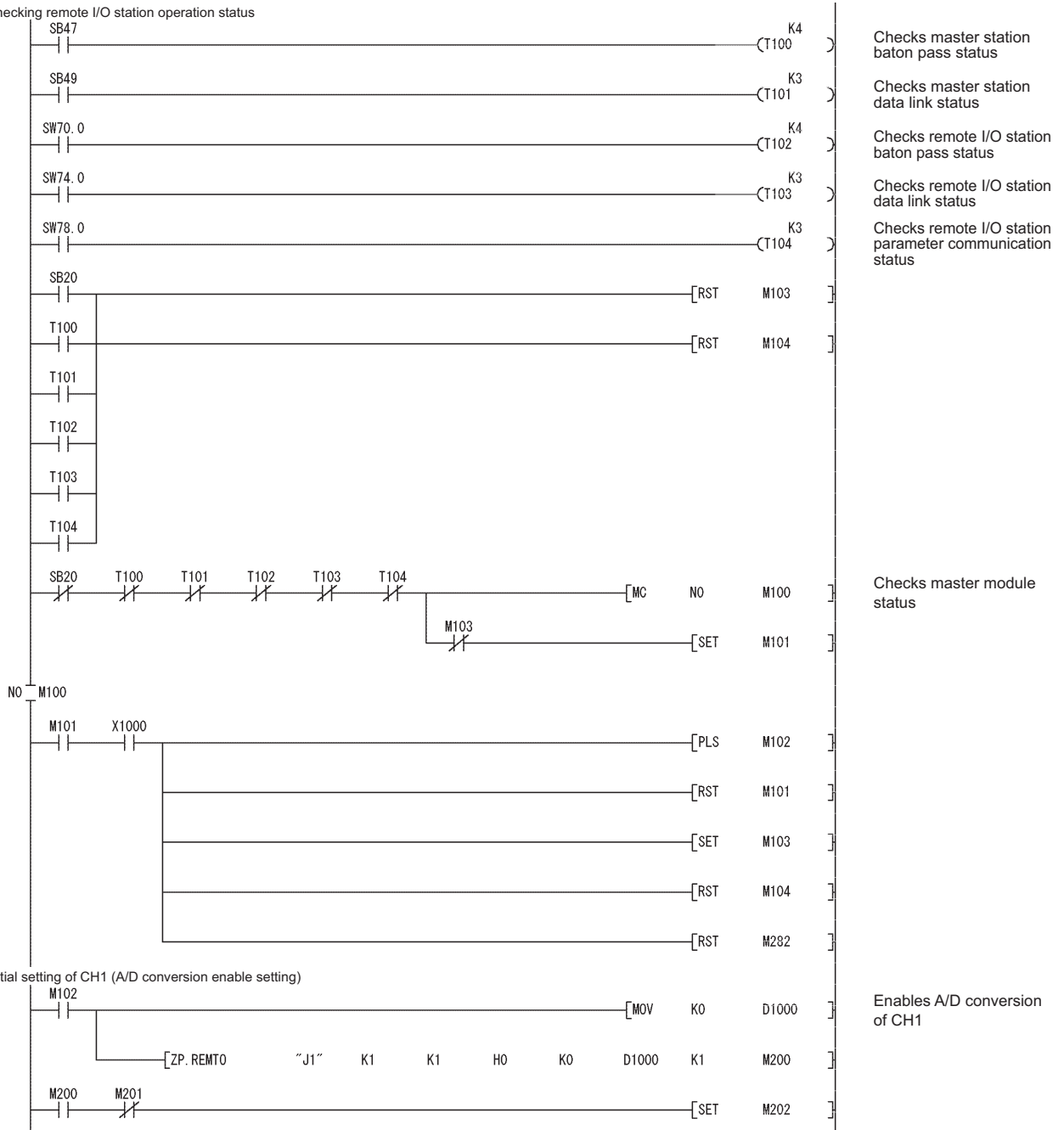

Figure 9.24 Program example without using GX Configurator-AD

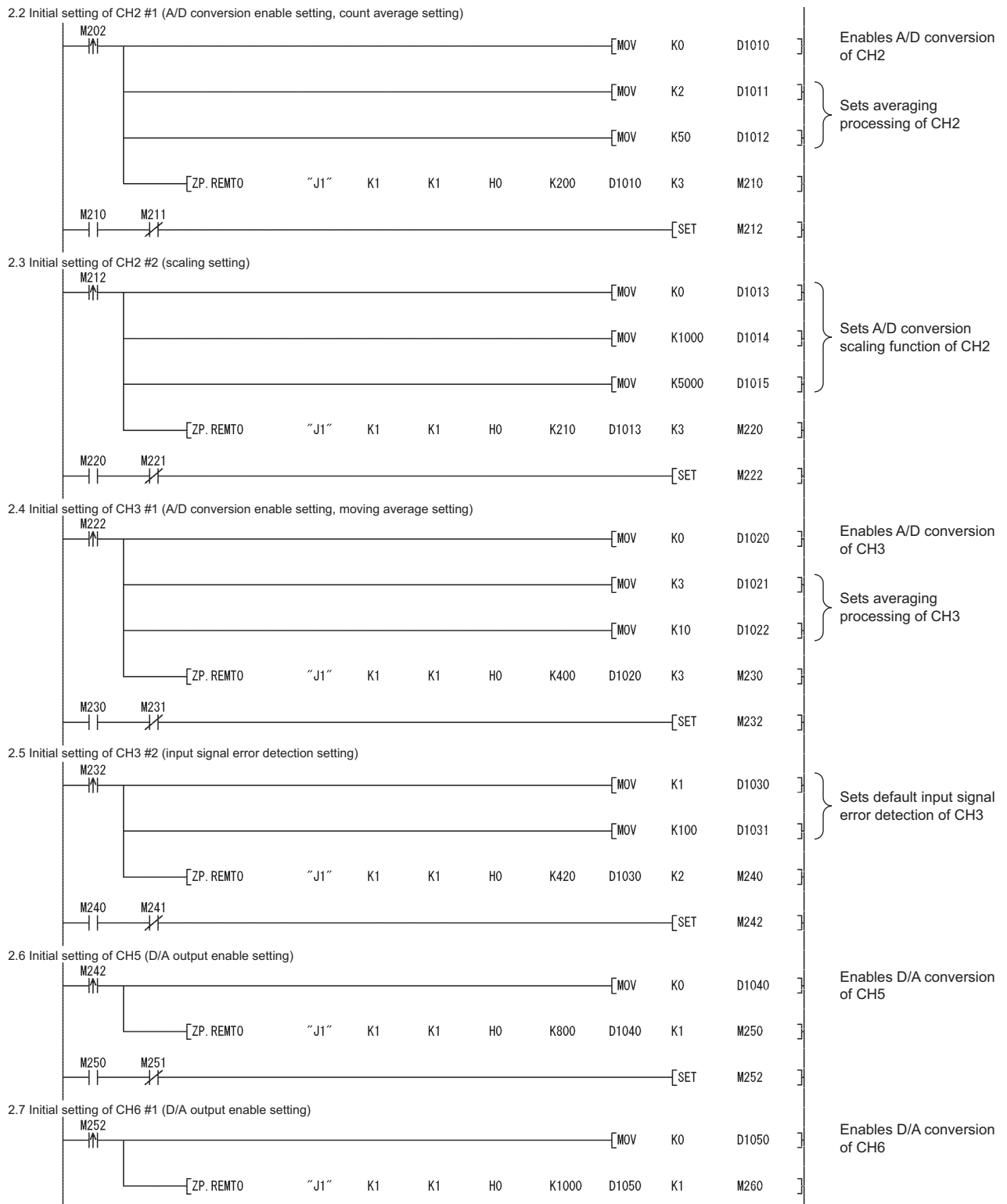

Figure 9.24 Program example without using GX Configurator-AD (continued)

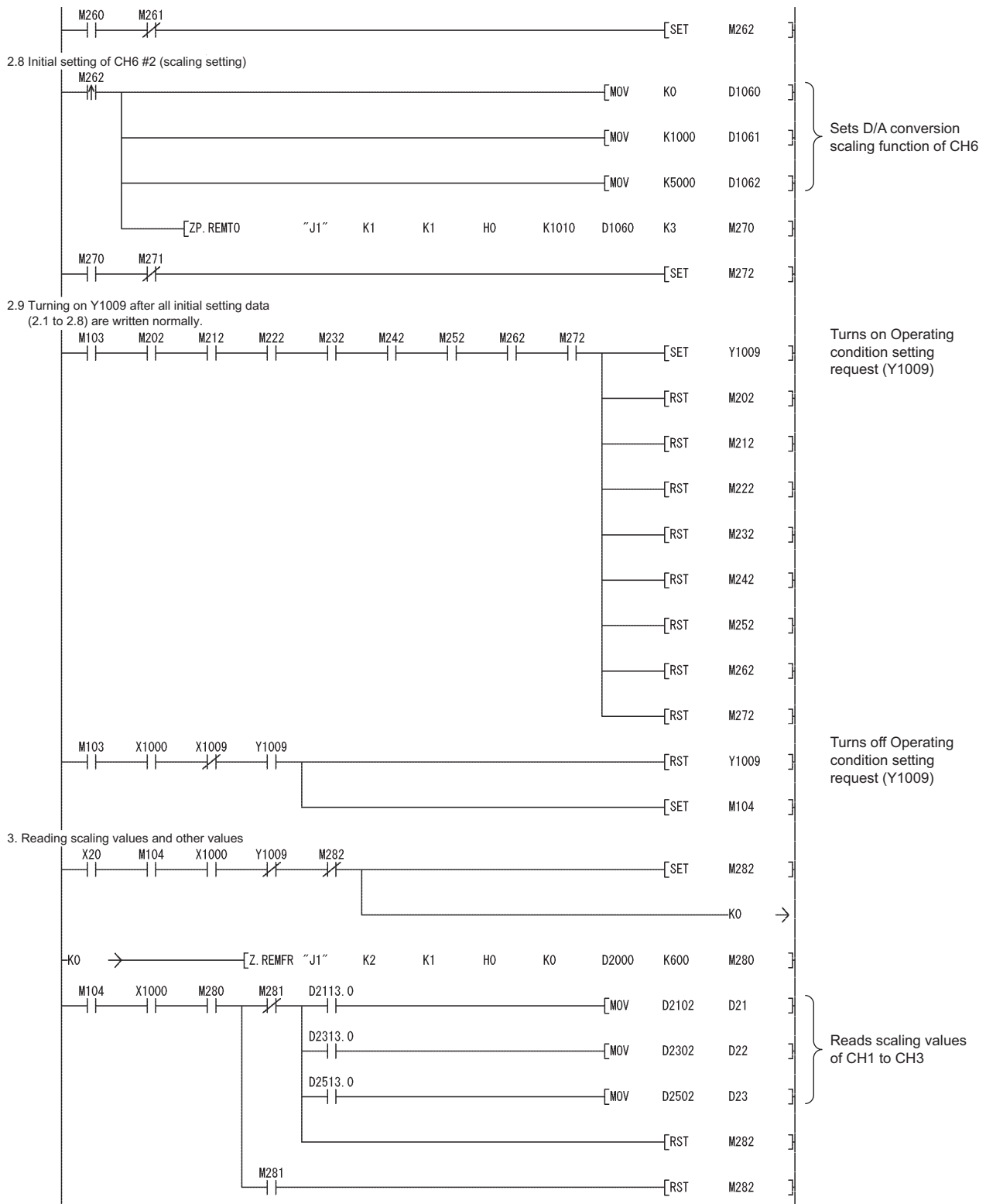

Figure 9.24 Program example without using GX Configurator-AD (continued)

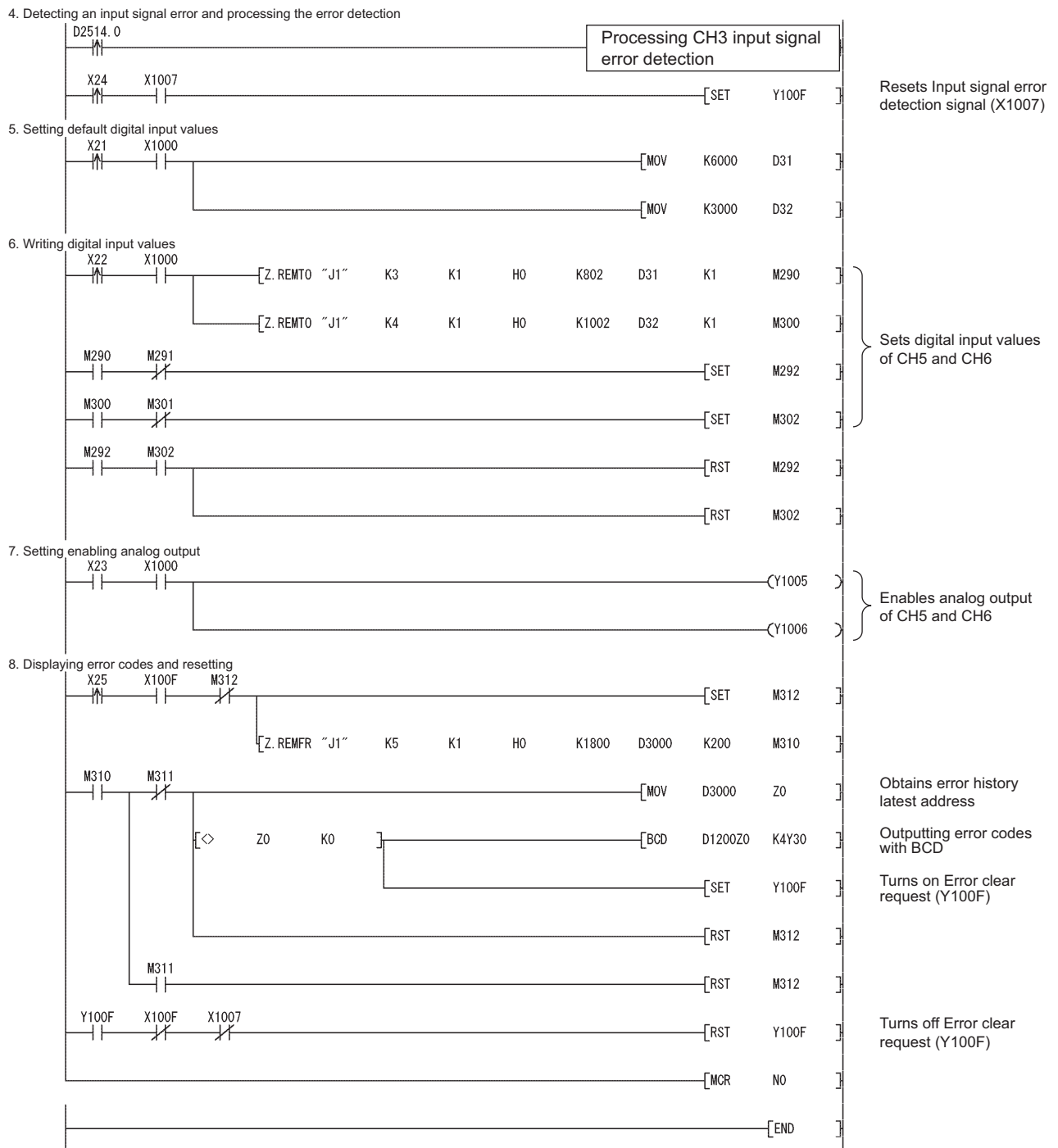

Figure 9.24 Program example without using GX Configurator-AD (continued)

CHAPTER10 ONLINE MODULE CHANGE

When changing a module online, carefully read the "Online module change" section in the QCPU User's Manual (Hardware Design, Maintenance and Inspection).

This chapter explains the specifications of the online module change.

[Precautions]

This chapter explains using device numbers (X/Y) and buffer memory addresses for CH1 and CH5. Apply the same operations when changing a module online using other channels.

For device numbers and buffer memory addresses for other channels, refer to Section 5.1 and Section 6.1.

Change a module online with GX Developer.

POINT

- (1) Perform an online module change after making sure that the system outside the programmable controller will not malfunction.
 - (2) To prevent an electric shock and malfunction of operating modules, provide means such as switches for powering off each of the external power supply and external devices connected to the module to be replaced online.
 - (3) It is recommended to perform an online module change in the actual system in advance to ensure that it would not affect the other modules by checking the following:
 - Means of cutting off the connection to external devices and its configuration are correct.
 - Switching on/off does not bring any undesirable effect.
 - (4) After the first use of the product, do not mount/remove the module to/from the base unit more than 50 times (IEC 61131-2 compliant) respectively. Exceeding the limit of 50 times may cause malfunction.
-

10.1 Execution Condition of Online Module Change

To change a module online, the following CPU module, MELSECNET/H remote I/O module, Q64AD2DA, GX Developer, and base unit are required.

(1) CPU module

The Process CPU or Redundant CPU are required.

For precautions for redundant system configuration, refer to the QnPRHCPU User's Manual (Redundant System).

(2) MELSECNET/H remote I/O module

Use the module of function version D or later.

(3) GX Developer

Use GX Developer Version 7.10L or later.

Use GX Developer Version 8.18U or later to change a module on the remote I/O station online.

(4) Base unit

(a) When the slim type main base unit (Q3□SB) is used, a module cannot be changed online.

(b) When the extension base unit (type requiring no power supply module (Q5□B)) is used, modules on the base units connected to the extension base unit cannot be changed online.

Remark

.....
The online module change is supported by the Q64AD2DA of the first product to the function version C.
.....

10.2 Operations During Online Module Change

The following table shows operations during online module change.

Table 10.1 Operations during online module change

CPU operation ○ : Performed × : Not performed						(User operation)	(Operation of intelligent function module)
X/Y refresh	FROM/TO instructions *1	Dedicated instruction	Device test	GX Configurator			
				Initial setting parameter	Monitor/test		
○	○	○	○	×	○	<p>(1) Disabling conversion</p> <p>Turn off all Y signals that have been turned on by a sequence program.</p> <p>(2) Removing a module</p> <p>Start an online module change operation using GX Developer.</p> <p>Click the Execution button on the dialog box to enable a module replacement.</p> <p>Remove the target module.</p> <p>(3) Mounting a new module</p> <p>Mount a new module.</p> <p>After mounting the module, click the Execution button on the dialog box of GX Developer.</p> <p>Operation check before start of control</p> <p>(4) Checking operation</p> <p>Click the Cancel button to leave the online module change mode.</p> <p>Conduct an operation test on the new module by using the Device test dialog box of GX Developer or the Monitor/Test screen of GX Configurator.</p> <p>Completion of operation check</p> <p>(5) Restarting control</p> <p>Resume the online module change mode using GX Developer and click the Execution button to restart control.</p>	<p>Module operates normally.</p> <p>Module stops operation.</p> <ul style="list-style-type: none"> • RUN LED is off. • Conversion is disabled. <p>X/Y refresh resumes and module starts operation.</p> <ul style="list-style-type: none"> • RUN LED is on. • Module operates with default settings. (X0 remains off.) <p>If initial setting parameters have been set, module operates according to them at this point.</p> <p>Module operates according to test operation. *2</p> <p>Module ready (X0) turns on.</p> <p>Module operates according to sequence program which performs initial setting on the rising edge of X0. *2</p>
×	×	×	×	×	×		
○	×	×	×	○	×		
○	×	×	○	×	○		
○	○	○	○	×	○		

* 1 Access to the intelligent function module device (U□\G□) is included.

* 2 In the case of absence of the operation marked *2, the intelligent function module performs the operation prior to the marked operation.

10.3 Procedures of Online Module Change

This section explains the procedures of online module change when an initial setting of GX Configurator-AD or GX Configurator-DA is configured and when the initial setting is not configured.

Table 10.2 Procedures of online module change

Initial setting	Reference
GX Configurator-AD or GX Configurator-DA	Section 10.3.1
Sequence program	Section 10.3.2

10.3.1 When the initial setting has been configured with GX Configurator-AD or GX Configurator-DA

(1) Disabling conversion

- (a) Take the following steps to disable the conversion:
 - 1) Set CH1 A/D conversion enable/disable (Un\G0) and CH5 D/A conversion enable/disable (Un\G800) to Disable (1).
 - 2) Turn Operating condition setting request (Y9) from off to on to stop the conversion.
 - 3) Operating condition setting completed flag (X9) turns off from on.
 - 4) Check that CH1 A/D conversion completed flag (Un\G113) is in a status of Conversion stop (0) and the conversion is stopped by seeing the actual analog output value.
 - 5) Turn Operating condition setting request (Y9) from on to off.

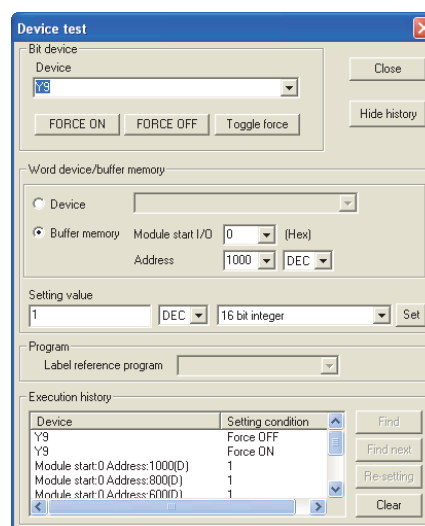

Figure 10.1 "Device test" dialog box

(2) Removing a module

- (a) After choosing "Online module change" Mode in the dialog box opened by selecting [Diagnostics] → [Online module change] of GX Developer, double-click a module to be changed online to display the "Online module change" dialog box.

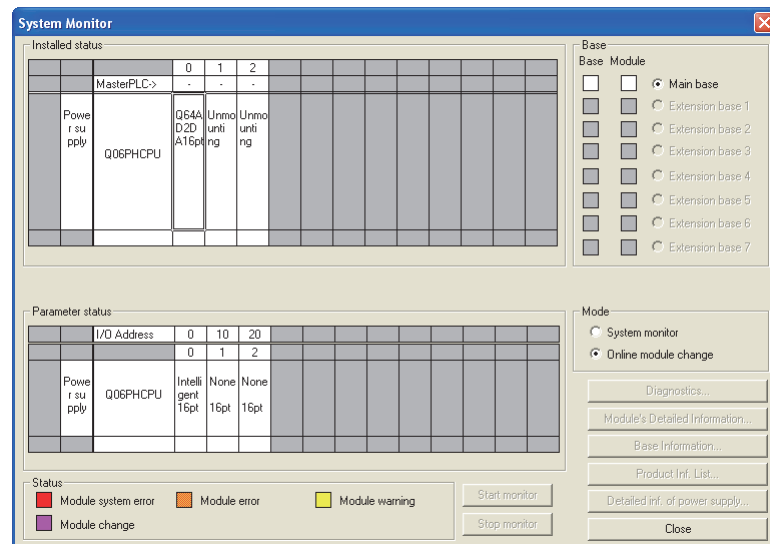

Figure 10.2 "System Monitor" dialog box

- (b) Click the **Execution** button to enable the online module change.

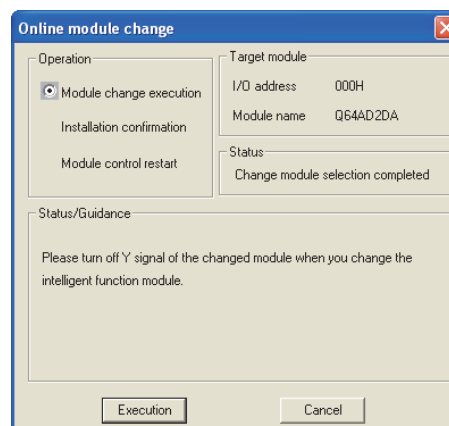

Figure 10.3 "Online module change" (module change execution) dialog box

If the following error dialog box appears, click the **OK** button, remove the module, and mount a new module.

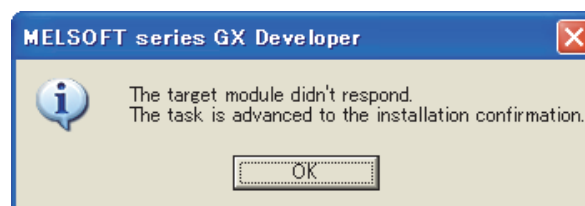

Figure 10.4 Error dialog box

- (c) After checking that the RUN LED of the module turned off, remove the terminal block, external power supply connector, and then the module.

POINT

Always remove the module. If mounting status is checked without the module removed, the module will not properly start and the RUN LED will not turn on.

(3) Mounting a new module

- (a) Mount a new module on the same slot, and install a terminal block and external power supply connector.
- (b) After mounting the module, click the **Execution** button and make sure that the RUN LED turns on. Module ready (X0) remains off.

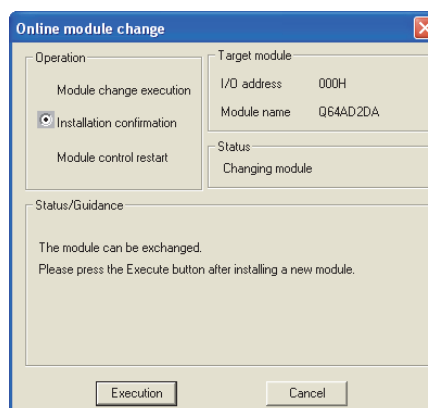

Figure 10.5 "Online module change" (mounting check) dialog box

(4) Operation check

- (a) To check operations, click the **Cancel** button and see if the restart of control is canceled.

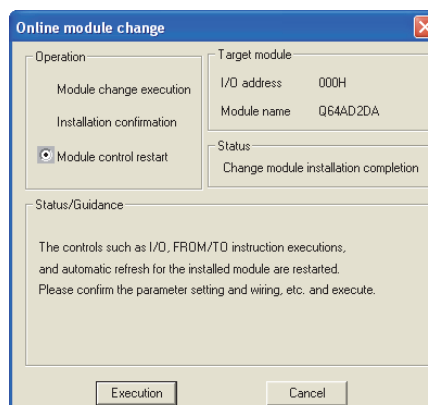

Figure 10.6 "Online module change" (restart of module control) dialog box

(b) Click the **OK** button to suspend the online module change mode.

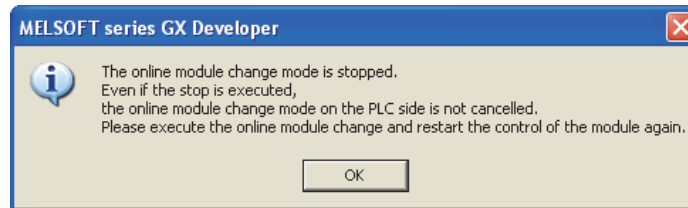

Figure 10.7 Dialog box informing the suspension of online module change mode

(c) Click the **Close** button to close the "System Monitor" dialog box.

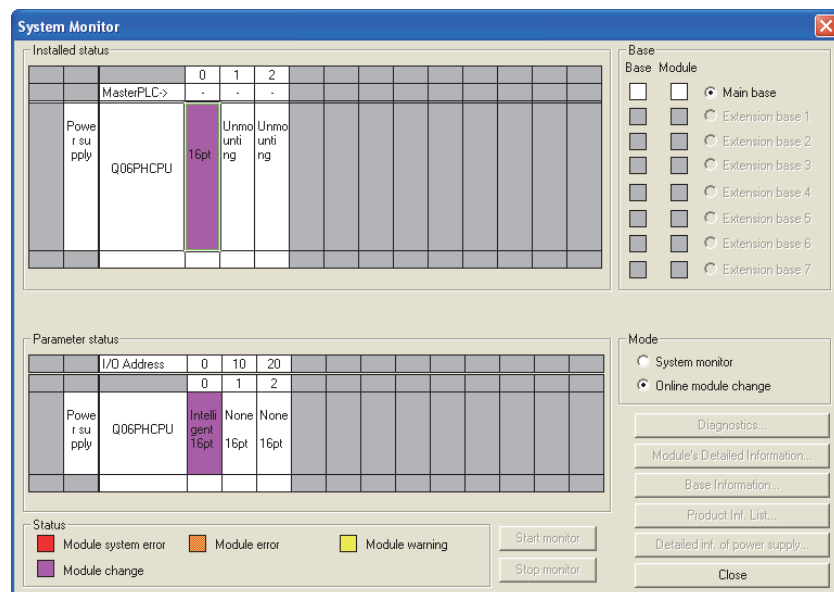

Figure 10.8 "System Monitor" dialog box

- (d) Set CH1 A/D conversion enable/disable setting (Un\G0) or CH5 D/A conversion enable/disable setting (Un\G800) to "Enable" (0) and turn off and then on Operating condition setting request (Y9).
- 1) A/D conversion (CH1 to CH4)
Monitor CH1 Digital output value (Un\G100) to check if A/D conversion is properly performed.
 - 2) D/A conversion (CH5 and CH6)
Set CH5 Digital input value (Un\G802) and turn off and then on CH5 Output enable/disable flag (Y5) to check if D/A conversion is properly performed.
(Be careful since analog values will be output.)

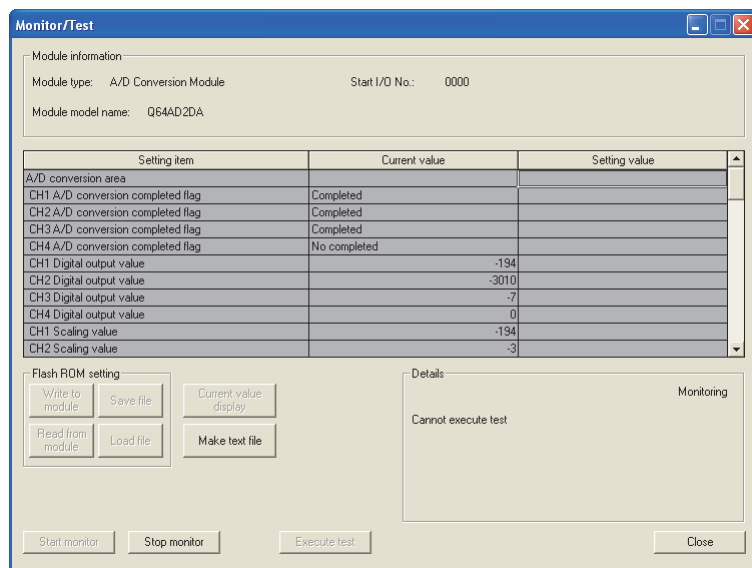

Figure 10.9 "Monitor/Test" window

(5) Restarting control

- (a) After redisplaying the "Online module change" dialog box by selecting [Diagnostics] → [Online module change] of GX Developer, click the **Execution** button to restart controls such as I/O, FROM/TO instruction executions, and automatic refresh for the module.

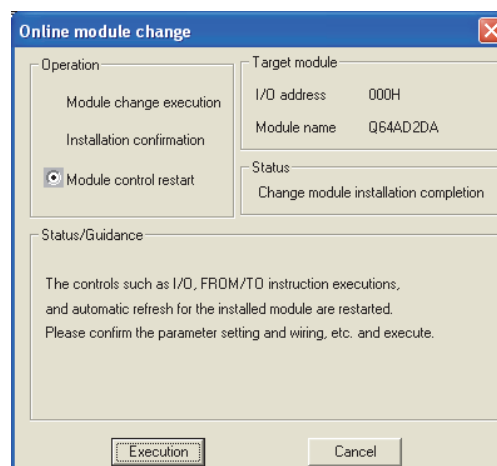

Figure 10.10 "Online module change" (restart of module control) dialog box

(b) Dialog box informing the completion of online module change appears.



Figure 10.11 Dialog box informing the completion of online module change

10.3.2 When the initial setting has been configured with sequence program

(1) Disabling conversion

- (a) Take the following steps to disable the conversion:
- 1) Set CH1 A/D conversion enable/disable (Un\G0) and CH5 D/A conversion enable/disable (Un\G800) to Disable (1).
 - 2) Turn Operating condition setting request (Y9) from off to on to stop the conversion.
 - 3) Operating condition setting completed flag (X9) turns off from on.
 - 4) Check that CH1 A/D conversion completed flag (Un\G113) is in a status of Conversion stop (0) and the conversion is stopped by seeing the actual analog output value.
 - 5) Turn Operating condition setting request (Y9) from on to off.

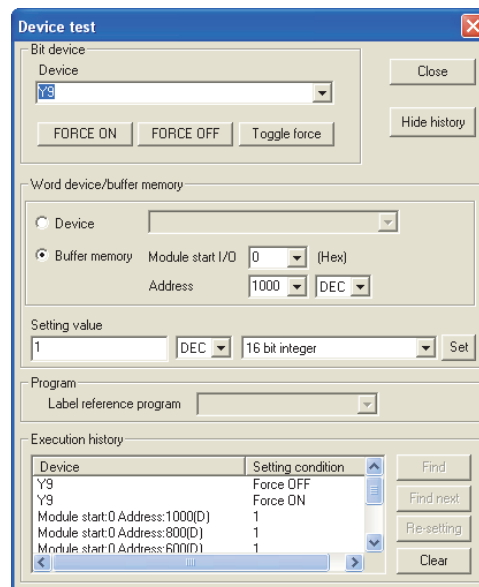

Figure 10.12 "Device test" dialog box

(2) Removing a module

- (a) After choosing "Online module change" Mode in the dialog box opened by selecting [Diagnostics] → [Online module change] of GX Developer, double-click a module to be changed online to display the "Online module change" dialog box.

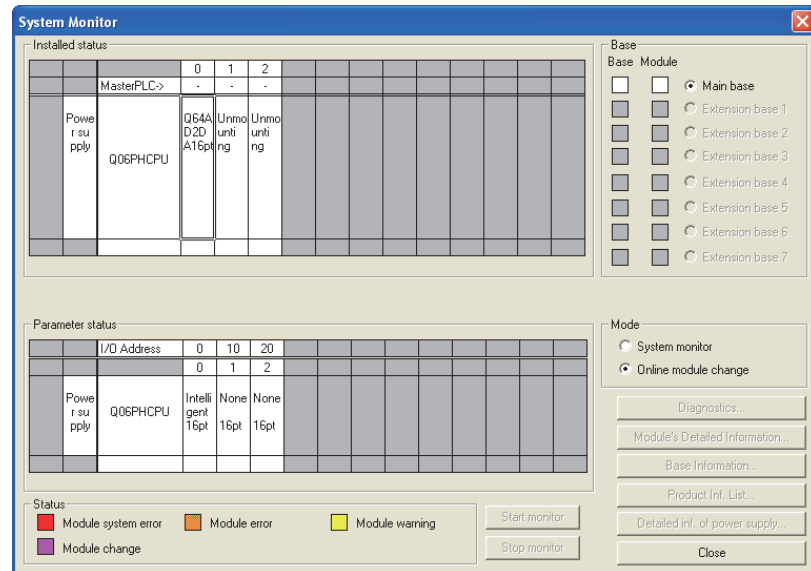

Figure 10.13 "System Monitor" dialog box

- (b) Click the **Execution** button to enable the online module change.

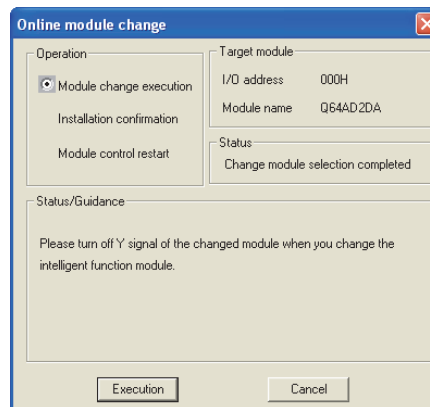

Figure 10.14 "Online module change" (module change execution) dialog box

If the following error dialog box appears, click the **OK** button, remove the module, and mount a new module.

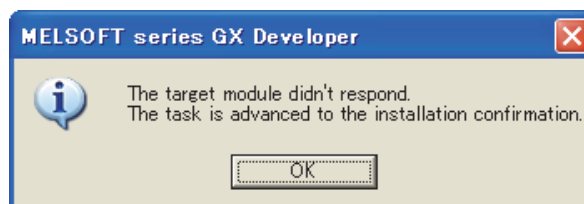

Figure 10.15 Error dialog box

- (c) After checking that the RUN LED of the module turned off, remove the terminal block, external power supply connector, and then the module.

POINT

Always remove the module. If mounting status is checked without the module being removed, the module will not properly start and the RUN LED will not turn on.

(3) Mounting a new module

- (a) Mount a new module on the same slot, and install a terminal block and external power supply connector.
- (b) After mounting the module, click the **Execution** button and make sure that the RUN LED turns on. Module ready (X0) remains off.

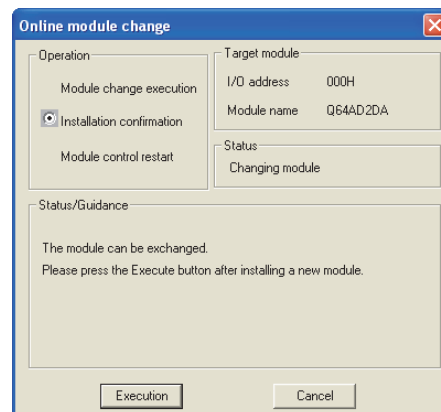

Figure 10.16 "Online module change" (mounting check) dialog box

(4) Operation check

- (a) To check operations, click the **Cancel** button and see if the restart of control is canceled.

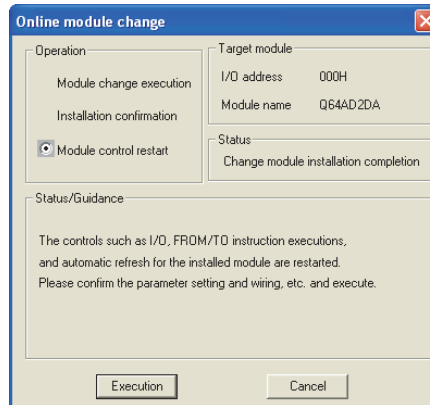

Figure 10.17 "Online module change" (restart of module control) dialog box

- (b) Click the **OK** button to suspend the online module change mode.

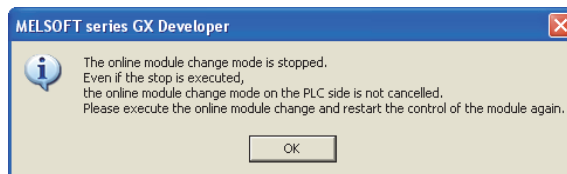

Figure 10.18 Dialog box informing the suspension of online module change mode

- (c) Click the **Close** button to close the "System Monitor" dialog box.

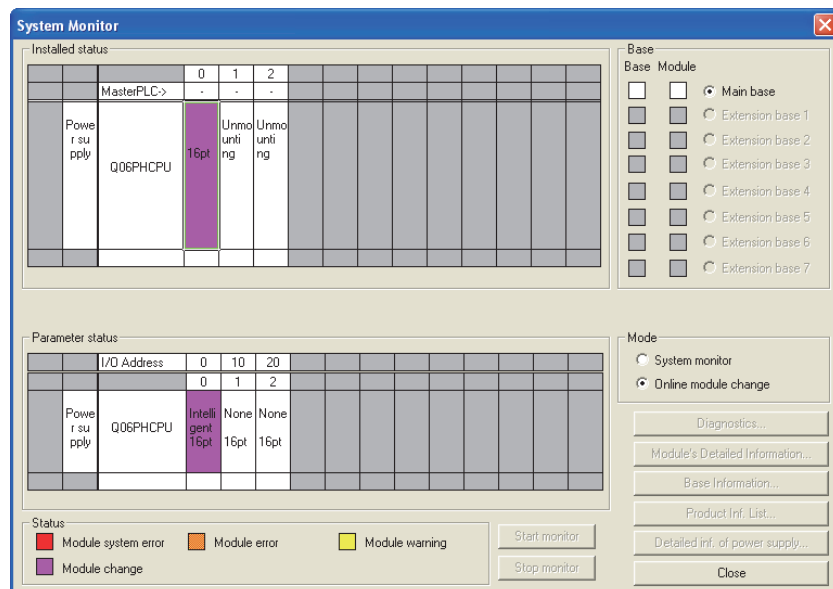

Figure 10.19 "System Monitor" dialog box

- (d) Set CH1 A/D conversion enable/disable setting (Un\G0) or CH5 D/A conversion enable/disable setting (Un\G800) to "Enable" (0) and turn off and then on Operating condition setting request (Y9).
 - 1) A/D conversion (CH1 to CH4)
Monitor CH1 Digital output value (Un\G100) to check if A/D conversion is properly performed.
 - 2) D/A conversion (CH5 and CH6)
Set CH5 Digital input value (Un\G802) and turn off and then on CH5 Output enable/disable flag (Y5) to check if D/A conversion is properly performed.
(Be careful since analog values will be output.)

- (e) Since the new module is in default status, it must be initialized by a sequence program after control restart.
Before initialization, check if the contents of the initialization program is correct.
 - 1) Normal system configuration
The sequence program should perform initialization on the leading edge of Module ready (X0) of the Q64AD2DA.
When control resumption is executed, Module ready (X0) turns on and initialization is performed. (If the sequence program performs initialization only for one scan after RUN, initialization is not performed.)
 - 2) System using a remote I/O network
Create a user device that performs initialization at any timing (Initial setting request signal) in the sequence program. After control restart, turn on Initial setting request signal to perform initialization. (If the sequence program is created so that initialization may be performed only for one scan after the data link start in the remote I/O network, initialization is not performed.)

(5) Restarting control

- (a) After choosing [Diagnostics] → [Online module change] in GX Developer to display the "Online module change" screen again, click the **Execution** button to resume controls such as I/O, FROM/TO instruction executions, and automatic refresh for the module.

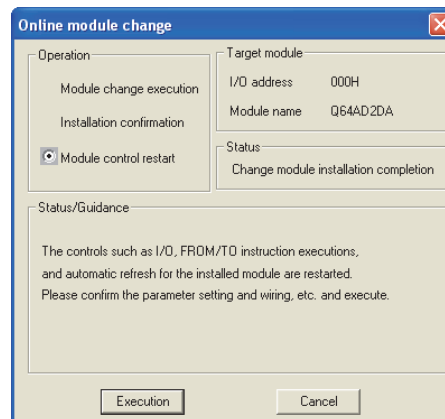

Figure 10.20 "Online module change" (restart of module control) screen

- (b) Dialog box informing the completion of online module change appears.



Figure 10.21 Dialog box informing the completion of online module change

CHAPTER 11 TROUBLESHOOTING

This chapter describes the errors which may occur during the use of the Q64AD2DA and troubleshooting.

The device numbers (X or Y) and buffer memory addresses described in this chapter are used for the channel 1. (The device numbers and buffer memory addresses specified in D/A conversion are used for CH5.)

For the device numbers and buffer memory addresses used for the other channels, refer to Section 5.1 and Section 6.1.

11.1 Error Code List

If an error occurs when data is written to/read from the CPU module, the Q64AD2DA writes the corresponding error code to the buffer memory address.

(1) Storage area for latest error code and error time

Table 11.1 Storage area of buffer memory address for latest error code and error time

Error occurrence channel	Latest error code	Error time	Reference section
CH1	Un\G190	Un\G191 to Un\G194	(3)(b) in this section
CH2	Un\G390	Un\G391 to Un\G394	
CH3	Un\G590	Un\G591 to Un\G594	
CH4	Un\G790	Un\G791 to Un\G794	
CH5	Un\G990	Un\G991 to Un\G994	
CH6	Un\G1190	Un\G1191 to Un\G1194	(3)(a) in this section
-	Un\G1790	Un\G1791 to Un\G1794	

(2) Storage area for error history

Up to last 16 error logs are stored into the Error history (Un\G1810 to Un\G1964).

POINT

- (1) The data of error time are stored into CH1 Error time (Un\G191 to Un\G194) and Error time (Un\G1791 to Un\G1794) on the basis of the CPU module time information. If the error time is wrong, check the time setting of the CPU module.
- (2) When using network modules, the error time may not be stored as follows:
When using the Q64AD2DA in the MELSECNET/H remote I/O network, the time information is transferred as shown below. Therefore, the sequence of power supply for the system and the error timing may result in storing wrong information at the point of error occurrence.
 - CPU module → MELSECNET/H master module → MELSECNET/H remote module → Q64AD2DA

[Example] The remote module is powered on firstly and the CPU module is powered on secondly. Consequently, an error occurs immediately after the remote module is powered on.

(3) Error code list

Errors are classified into two levels: moderate (module error) and minor (module warning).

When a moderate error occurs, conversion processing is not performed.

When a minor error occurs, conversion processing is performed with the settings that the system operated normally last time.

(a) Errors unrelated to channels

Table 11.2 lists the error codes unrelated to channels.

If an error occurs, the error code will be written to Latest error code (Un\G1790).

Table 11.2 Errors unrelated to channels

Error code (decimal)	Corresponding channel	Error level	Description	Corrective action	Reference section
1 ^{*1}	-	Mode rate	A hardware error of the module	Power off the module, then on again. If the same error occurs, the module may have failed. Please consult your local Mitsubishi representative.	-
2 ^{*1}	-	Mode rate	A value other than 0 _H is set to the Switch 5 in the intelligent function module switch setting.	Set 0 _H to the Switch 5 in the intelligent function module switch setting of GX Developer.	Section 7.5.2

* 1 Setting Error clear request (YF) to on cannot clear this error code.

(b) Errors related to channels

Table 11.3 lists the error codes related to channels.

If an error occurs, the error code will be written to CH1 Latest error code (Un\G190) according to the channel where the error occurs.

Table 11.3 Errors related to channels

Error code (decimal) ^{*1}	Corresponding channel	Error level	Description	Corrective action	Reference section
□000 ^{*2}	1 to 6	Mode rate	The setting range is set with an illegal value in the intelligent function module switch setting in GX Developer.	Set a correct parameter value in the parameter setting of GX Developer.	Section 7.5.2
□002		Minor	A value other than 0 or 1 is set to CH1 A/D conversion enable/disable setting (Un\G0) or CH5 D/A conversion enable/disable setting (Un\G800).	Reset 0 or 1 to enable or disable the conversions.	Section 6.2 Section 6.29
□003	5 and 6	Minor	The digital input values set in CH5 Digital input value (Un\G802) for D/A conversion channels are out of the setting range.	Check CH5 Set value check code (Un\G900), and then reset the digital input value to within the range.	Section 6.30 Section 6.34
□200	1 to 4	Minor	A value other than 0, 1, 2, or 3 is set to CH1 Averaging process method setting (Un\G1).	Reset 0, 1, 2, or 3 for averaging process method setting.	Section 6.3
□201			A value other than the range from 2 to 10000ms is set to CH1 Averaging process (time / number of times) setting (Un\G2).	Reset the averaging time setting to within 2 to 10000ms. Also, the set value must be "4 (times) × 0.5(ms) × Number of channels used (total number of A/D conversion and D/A conversion)" or greater.	Section 6.4

Table 11.3 Errors related to channels (continued)

Error code (decimal)*1	Corresponding channel	Error level	Description	Corrective action	Reference section
□202	1 to 4	Minor	A value other than the range from 4 to 20000 times is set to CH1 Averaging process (time / number of times) setting (Un\G2).	Reset the averaging count setting to within 4 to 20000 times.	Section 6.4
□203			A value other than the range from 2 to 60 times is set to CH1 Averaging process (time / number of times) setting (Un\G2).	Reset the averaging count setting to within 2 to 60 times.	Section 6.4
□210			A value other than 0, 1, 2, 3, or 4 is set to CH1 Input signal error detection setting (Un\G20).	Reset 0, 1, 2, 3, or 4 for the input signal error detection setting.	Section 6.8
□211			A value other than the range from 0 to 250 is set to CH1 Input signal error detection setting value (Un\G21).	Reset the input signal error detection setting value to within 0 to 250.	Section 6.9
□212			CH1 Input signal error detection setting (Un\G20) is set to detect disconnection (4) for the channels where the following input ranges are not set. •4 to 20mA (Extended mode) •1 to 5V (Extended mode)	[Disconnection detection function used] •Set the input range to within 4 to 20mA (Extended mode) or 1 to 5V (Extended mode). [Disconnection detection function unused] •Set the input signal error detection setting to 0, 1, 2, or 3.	Section 6.8 Section 7.5.2
□250			CH1 Logging enable/disable setting (Un\G30) set to the value other than 1 or 2.	Reset the logging enable /disable setting to 0 or 1.	Section 6.10
□251			Either or both of the values for the following is or set outside the setting ranges. •CH1 Logging cycle setting value (Un\G31) •CH1 Logging cycle unit setting (Un\G32)	Reset both or either of the logging cycle setting value and logging cycle unit setting to within the setting ranges. (For the details of the logging cycle, refer to POINT of Section 6.11.)	Section 6.11
			The logging cycle falls under the updating cycle of the logging data.	Reset the logging cycle to be the updating cycle of the logging data or more. (For the details of the logging cycle, refer to Section 6.11.)	
□252			A value other than 0 or 1 is set to CH1 Logging data setting (Un\G33).	Reset the logging data setting to 0 or 1.	Section 6.12
□253			A value other than the range from 0 to 9999 is set to CH1 Logging points after trigger (Un\G34).	Reset the logging points after the trigger occurrence to within 0 to 9999.	Section 6.13
□254	A value other than 0, 1, 2, or 3 is set to CH1 Level trigger condition setting (Un\G35).	Reset the level trigger condition setting to 0, 1, 2, or 3.	Section 6.14		
□255	A value other than the range from 0 to 1999 is set to CH1 Trigger data (Un\G36).	Reset the trigger data to within 0 to 1999.	Section 6.15		
□400	1 to 6	Minor	A value other than 0 or 1 is set to CH1 A/D conversion scaling enable/disable setting (Un\G10) or CH5 D/A conversion scaling enable/disable setting (Un\G810).	Reset the setting whether to enable or disable scaling to 0 or 1.	Section 6.5 Section 6.31

Table 11.3 Errors related to channels (continued)

Error code (decimal) ^{*1}	Corresponding channel	Error level	Description	Corrective action	Reference section
□401	1 to 6	Minor	<ul style="list-style-type: none"> A value less than -32000 is set to CH1 A/D conversion scaling lower limit value (Un\G11) or CH5 D/A conversion scaling lower limit value (Un\G811). A value more than 32000 is set to CH1 A/D conversion scaling upper limit value (Un\G12) or CH5 D/A conversion scaling upper limit value (Un\G812). 	Reset the scaling upper or lower limit value to within -32000 to 32000.	Section 6.6 Section 6.32
□402			<ul style="list-style-type: none"> The value of CH1 A/D conversion scaling lower limit value (Un\G11) is set to be equal to or greater than the value of CH1 A/D conversion scaling upper limit value (Un\G12). The value of CH5 D/A conversion scaling lower limit value (Un\G811) is set to be equal to or greater than the value of CH5 D/A conversion scaling upper limit value (Un\G812). 	Reset the scaling upper and lower limit values to (Lower limit value < Upper limit value).	Section 6.31 Section 6.32

* 1 □ indicates the error channel number (1 to 6). For information on the buffer memory for CH2 or later, refer to Section 6.1.

* 2 Setting on Error clear request (YF) does not clear the error code.

POINT

- The error code can be cleared by setting Error clear request (YF) to on during the error occurrence. Otherwise, resetting the setting value within the setting range and then setting Operating condition setting request (Y9) to on clear the error code. However, the error code marked ^{*2} shown in Table 11.2 and Table 11.3 cannot be cleared by setting Error clear request (YF) or Operating condition setting request (Y9) to on.
- If more than one error occur, the error codes will be stored as follows:
 - If more than one error unrelated to channels occur, the error code of the latest error will be stored into Latest error code (Un\G1790).
 - If more than one error related to CH1 occur, the error code of the latest error will be stored into CH1 Latest error code (Un\G190).
The errors related to CH2 to CH6 will be processed, likewise.
 - All the errors will be stored into Error history (Un\G1810 to Un\G1964) in occurrence order regardless of whether the error is related or not related to the channel.

11.2 Troubleshooting

11.2.1 When "RUN" LED turns off

Table 11.4 When "RUN" LED turns off

Check item	Corrective action	Reference section
Is power supplied?	Check that the supply voltage of the power supply module is within the rated range.	Section 3.1
Is the capacity of the power supply module sufficient?	Calculate the current consumption of the CPU, I/O, intelligent function and other modules mounted on the base unit, and make sure that the capacity of the power supply module is enough.	-
Has a watchdog timer error occurred?	Reset the programmable controller CPU and check that the "RUN" LED turns on. If the "RUN" LED does not turn on, the module may have failed. Please consult your local Mitsubishi representative, explaining a detailed description of the problem.	-
Is the module mounted correctly on the base unit?	Check the module mounting status.	-
Is the module in the online module change enable status?	Refer to CHAPTER 10 and take corrective action.	CHAPTER 10
Is "Empty" selected for the slot to be mounted in the I/O assignment tab of the PLC Parameter box in GX Developer?	Select "Intelli." for the type of the slot to be mounted again.	Section 7.5.1

11.2.2 When "ERR" LED turns on or blinks

(1) When "ERR" LED turns on

Table 11.5 When "ERR" LED turns on

Check item	Corrective action	Reference section
Has an error occurred?	Check the error code with CH1 Latest error code (Un\G190) and Latest error code (Un\G1790), and then take the corrective action as described in Section 11.1.	Section 11.1

(2) When "ERR" LED blinks

Table 11.6 When "ERR" LED blinks

Check item	Corrective action	Reference section
Is the setting value of the intelligent function module "Switch 5" other than "0H"?	Set "0H" for the intelligent function module "Switch 5" in GX Developer.	Section 7.5.2

11.2.3 When "ALM" LED blinks

Table 11.7 When "ALM" LED blinks

Check item	Corrective action	Reference section
Has an input signal error occurred?	Check CH1 Input signal error detection flag (Un\G114).	Section 6.23

11.2.4 When digital output values cannot be read

Table 11.8 When digital output values cannot be read

Check item	Corrective action	Reference section
Is 24VDC external supply power being supplied?	Check that External power off flag (X6) is set to on and supply 24VDC external supply power to the external power supply connector terminal.	Section 5.2.1 Section 7.4.3
Is there any fault with the analog signal lines such as disconnection or wire break?	Check for faulty condition of the signal lines by a visual check and a continuity check.	CHAPTER 7
Is the CPU module in the STOP status?	Set the CPU module to the RUN status.	-
Is the input range setting correct?	Check CH1 Setting range (Un\G112) in the monitor of GX Developer. If the input range setting is incorrect, reset the intelligent function module "Switch 1" setting in GX Developer.	Section 6.21 Section 7.5.2
Is CH1 A/D conversion enable/disable setting (Un\G0) set to A/D conversion disabled (1)?	Check CH1 A/D conversion enable/disable setting (Un\G0) in the monitor of GX Developer and set the initial setting to enable A/D conversion (0) in the sequence program or utility package.	Section 6.2
Has Operating condition setting request (Y9) been executed?	Set Operating condition setting request (Y9) to off in GX Developer and check that the values are stored into CH1 Digital output value (Un\G100). If so, review the initial setting of the sequence program or utility package.	Section 5.2.2 Section 6.17
Is the value set for the averaging processing specification correct?	If CH1 Averaging process method setting (Un\G1) is set to average time, check that the following conditions are met in the setting. CH1 Averaging process (time / number of times) setting (Un\G2) ≥ 4 (times) $\times 0.5$ (ms) \times Number of channels (total number of A/D conversions and D/A conversions) If the above requirements are not met, 0 is stored into CH1 Digital output value (Un\G100).	Section 6.3 Section 6.4
In the case of current input are terminals (V+) and (I+) connected?	In the case of current input, connect terminals (V+) and (I+).	Section 7.4.2

POINT

The module may have failed if the digital output value cannot be read after proper corrective actions have been taken according to the above check items. Please consult your local Mitsubishi representative, explaining a detailed description of the problem.

11.2.5 When A/D conversion completed flag does not turn on during use in normal mode

Table 11.9 When A/D conversion completed flag does not turn on during use in normal mode

Check item	Corrective action	Reference section
Is an input signal error being generated?	Check CH1 Input signal error detection flag (Un\G114).	Section 6.23

11.2.6 When an analog output value is not output

Table 11.10 When an analog output value is not output

Check item	Corrective action	Reference section
Is 24VDC being supplied from the external power supply?	Check that External power off flag (X6) is set to on and supply 24VDC external supply power to the external power supply connector terminal.	Section 5.2.1 Section 7.4.3
Is there any fault with the analog signal lines such as broken or disconnected line?	Check for any abnormality on the signal lines by a visual check and a continuity check.	CHAPTER 7
Is the CPU module in the STOP status?	Set the CPU module to the RUN status.	-
Is the output setting range correct?	Check CH5 Setting range (Un\G912) in the monitor of GX Developer. If the output range setting is incorrect, redo GX Developer intelligent function module "Switch 2" setting.	Section 6.36 Section 7.5.2
Is the resolution mode setting correct?	Check the on or off status of High resolution mode status flag (X8). If the resolution mode setting is incorrect, redo the GX Developer intelligent function module "Switch 4" setting.	Section 5.2.1 Section 7.5.2
Is D/A conversion set to be disabled with CH5 D/A conversion enable/disable setting (Un\G800)?	Check CH5 D/A conversion enable/disable setting (Un\G800) in the monitor of GX Developer and set it to be enabled with the Developer monitor or set it to Enable (0) using the sequence program or utility package.	Section 6.29
Is CH5 Output enable/disable flag (Y5) set to off?	Check the on or off status of CH5 Output enable/disable flag (Y5) in the monitor of GX Developer. If Output enable/disable flag is set to off, review the initial setting for the sequence program or utility package.	Section 5.2.2
Is the digital value being written to the channel to be output?	Check CH5 Digital input value (Un\G802) in the monitor of GX Developer.	Section 6.30
Has Operating condition setting request (Y9) been executed?	Set Operating condition setting request (Y9) to off with GX Developer and check that the analog output is normal. If normal analog output is obtained, review the initial setting for the sequence program or utility package.	Section 5.2.2 Section 8.4 CHAPTER 9

11.2.7 Checking the Q64AD2DA status

(1) How to check error with GX Developer

The error code, LED status, and setting status of the intelligent function module switch setting can be checked in GX Developer.

(a) Detailed information of module

Select [Diagnostics] → [System monitor] → "Q64AD2DA" → **Module's Detailed Information**.

The latest error is displayed in the Present Error field. *1

When the **Error History** button is clicked, the latest eight error codes are displayed.

Check the nine or more than nine error codes in the buffer memory.*2

[Error code display]
Latest eight error codes are displayed.
These error codes are not displayed until when the **Error History** button is clicked.

[Latest error code]
A latest error code is displayed.

- One digit (Error unrelated to channels)
□
Error code
- Four digits (Error related to channels)
□ □ □ □
Error code for the target channels
Channel number of an error
The four digits "6002" refers to the error (error code □002) that occurred in CH6.

[Display format]
The error codes shown in Section 11.1 are formatted with decimal number.
Since the display format is set to the default of HEX, select DEC.

Figure 11.1 "Module's Detailed Information" dialog box

* 1 The latest error code among the error codes in the list shown in Section 11.1 (3) and Section 11.1 (3) is displayed in the Present Error field.

* 2 The error history can be checked in the buffer memory. (Refer to Section 11.1.)

(b) H/W information

Click the **H/W Information** button in the Module's Detailed Information dialog box.

1) H/W LED information (Left side in the Module's Detailed Information dialog box)

The LED status is displayed from 1) to 3) fields. The display indicated by the arrow 4) is not related to H/W LED information.

Table 11.11 LED status

No.	LED name	Status
1)	RUN LED	0000H: Indicates that LED turns off. 0001H: Indicates that LED turns on.
2)	ERR. LED	
3)	ALM LED	Alternate indication between 0000H and 0001H: Indicates that LED blinks.

2) H/W switch information (Right side in the Module's Detailed Information dialog box)

The setting status of the intelligent function module switch setting is displayed.

Table 11.12 Intelligent function module switch setting status

No.	Intelligent function module switch setting	Reference section
1	Switch 1: Input range setting (CH1 to CH4)	Section 7.5.2
2	Switch 2: Output range setting (CH5 and CH6)	
3	Switch 3: Analog output HOLD/CLEAR function setting (CH5 and CH6)	
4	Switch 4: Mode setting	
5	Switch 5: -	

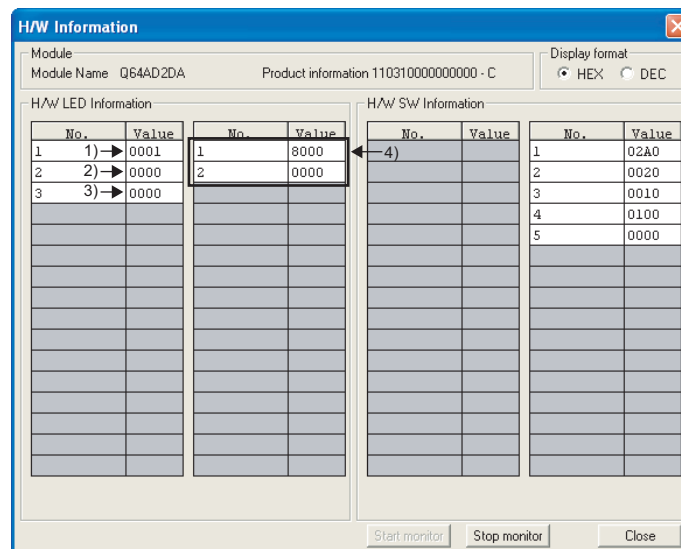

Figure 11.2 H/W Information dialog box

(2) How to check error with buffer memory

- (a) Current errors can be checked with buffer memory. (Refer to Section 11.1.)
- (b) Past errors can be checked with buffer memory. (Refer to Section 11.1.)

[Example]

If error codes are configured as the following order, each error information will be stored into buffer memory as shown in Figure 11.3.

- Error code 1002 → 2201 → 2402 → 5003

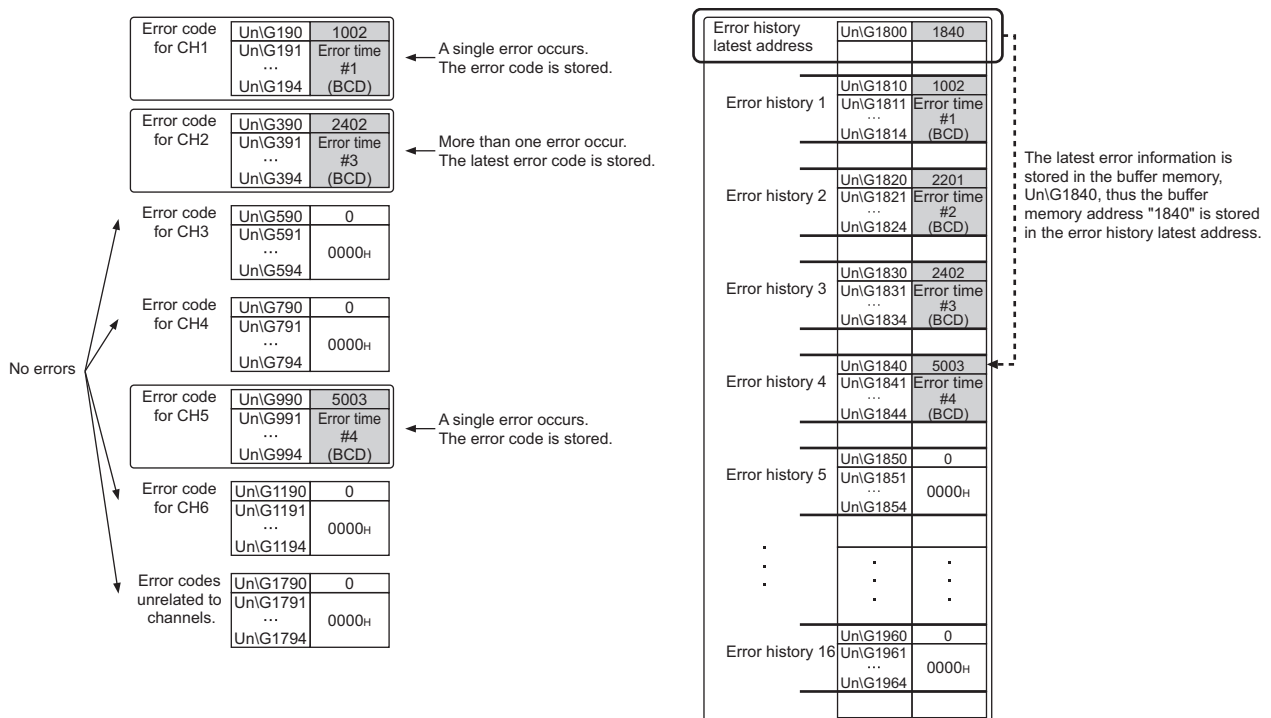

Figure 11.3 Buffer memory in the case of more than one error

The Module's Detailed Information dialog box in GX Developer shows the error history as shown below.

Up to last eight error history can be checked in the Module's Detailed Information dialog box. Newer error codes are displayed in the bottom of the error history field.

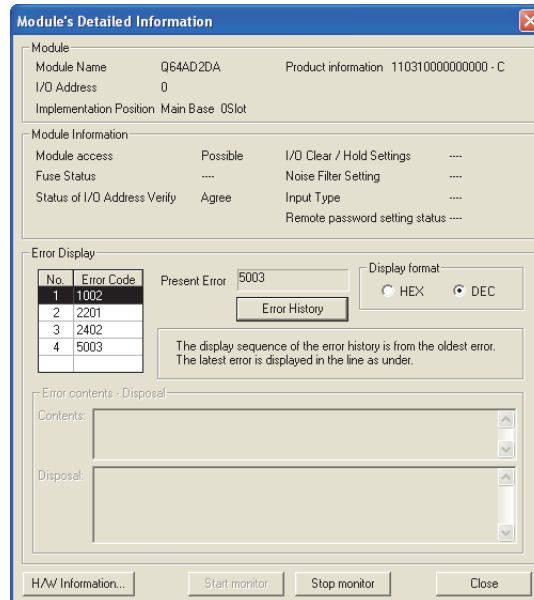
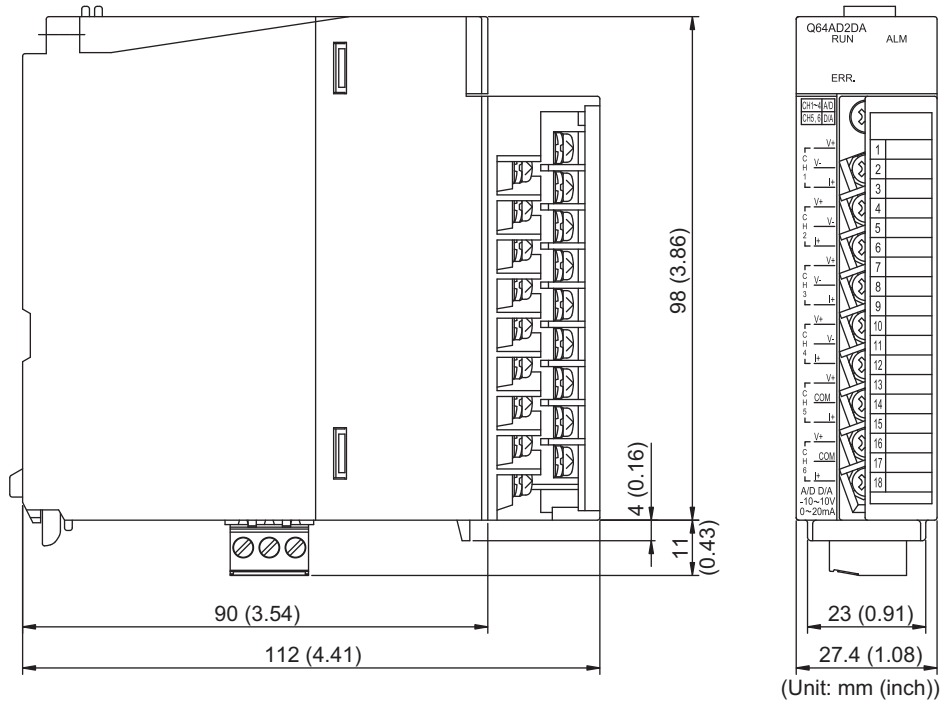

Figure 11.4 System monitor error history in the case of more than one error

APPENDIX

Appendix 1 External Dimensions



INDEX

[A]

ALM LED	7-4
Analog conversion enable/disable setting	4-33
Analog output HOLD/CLEAR function	4-25
Analog output HOLD/CLEAR function setting	7-15
Analog output test during a CPU module STOP	4-27
Auto refresh setting	8-16
Averaging process method setting (Un\G1)	6-10
Averaging process (time/number of times) setting (Un\G2)	6-11
Averaging processing	4-3
A/D conversion completed flag (Un\G113)	6-24
A/D conversion completed flag (XE)	5-7
A/D conversion enable/disable setting (Un\G0)	6-10
A/D conversion methods	4-3
A/D conversion scaling enable/disable setting (Un\G10)	6-11
A/D conversion scaling lower limit value (Un\G11)	6-12
A/D conversion scaling upper limit value (Un\G12)	6-12

[C]

Count average	4-4
---------------------	-----

[D]

Digital input value (Un\G802)	6-31
Digital output value (Un\G100, Un\G1700)	6-20
Disconnection detection	4-17
D/A conversion enable/disable setting (Un\G800)	6-30
D/A conversion scaling enable/disable setting (Un\G810)	6-32
D/A Conversion scaling lower limit value (Un\G811)	6-33
D/A conversion scaling upper limit value (Un\G812)	6-33
D/A output enable/disable function	4-25

[E]

EMC and Low Voltage Directives	A-12,7-6
Error clear request (YF)	5-10
Error code list	11-1
Error flag (XF)	5-8
Error time (Un\G191 to Un\G194)	6-29
ERR. LED	7-4
External dimensions	App-1
External power off flag (X6)	5-4
External power supply connector	7-4
External wiring	7-8

[F]

FB	1-2,8-23
----------	----------

FB conversion	8-21
Function version	2-5

[G]

Gain value	3-4,3-9
------------------	---------

[H]

High resolution mode status flag (X8)	5-6
Hold trigger	4-20
HOLD/CLEAR setting function (Un\G913)	6-35

[I]

Initial setting	8-14
Input range extended mode function	4-16
Input range setting	7-15
Input signal error detection flag (Un\G114)	6-25
Input signal error detection function	4-11
Input signal error detection setting value (Un\G21)	6-14
Input signal error detection setting (Un\G20)	6-13
Input signal error detection signal (X7)	5-5
Intelligent function module detailed setting	7-12
Intelligent function module switch setting	7-14
I/O conversion characteristic	3-4

[L]

Latest address of error history (Un\G1800)	6-37
Latest error code (Un\G190)	6-29
Latest pointer (Un\G121)	6-27
Level data (Un\G1600 to Un\G1609)	6-36
Level trigger condition setting (Un\G35)	6-17
List of I/O signals	5-1
Logging cycle setting value (Un\G31)	6-15
Logging cycle unit setting (Un\G32)	6-15
Logging data points (Un\G122)	6-28
Logging data setting (Un\G33)	6-16
Logging data storage area (Un\G5000 to Un\G14999)	6-38
Logging enable/disable setting (Un\G30)	6-14
Logging facility	4-18
Logging hold flag (X1)	5-3
Logging hold request (Y1)	5-9
Logging points after trigger (Un\G34)	6-16

[M]

Maximum and minimum values hold function	4-6
Maximum and minimum values reset completion flag (XD)	5-7
Maximum and minimum values reset request (YD)	5-10
Maximum digital output value (Un\G104, Un\G1720)	6-22
Maximum scaling value (Un\G108, Un\G1740)	6-23

Minimum digital output value (Un\G106, Un\G1721)	6-22
Minimum scaling value (Un\G110, Un\G1741)	6-23
Mode setting	7-15
Module ready (X0)	5-2
Monitor/Test	8-18
Moving average	4-5

[O]

Offset value	3-4,3-9
Offset/gain correction	7-16
Oldest pointer (Un\G120)	6-26
Online module change	10-1
Operating condition setting completion flag (X9)	5-6
Operating condition setting request (Y9)	5-10
Output enable/disable flag (Y5)	5-9
Output range setting	7-15

[P]

Programming	9-1
-------------	-----

[R]

Real conversion digital value (Un\G902, Un\G1774)	6-35
RUN LED	7-4

[S]

Sampling period	4-3
Sampling processing	4-3
Scaling function (A/D conversion)	4-6
Scaling function (D/A conversion)	4-28
Scaling value (Un\G102, Un\G1710)	6-21
Serial number	2-5
Set value check code (Un\G900, Un\G1764)	6-34
Settable range corresponding to the output ranges	4-31
Setting range (Un\G112)	6-24
Setting range (Un\G912)	6-35
Shifting amount to conversion value (Un\G13)	6-13
Shifting amount to input value (Un\G813)	6-33
Shifting function (A/D conversion)	4-9
Shifting function (D/A conversion)	4-31
Software version	2-2,2-7
Status check	11-8

[T]

Time average	4-3
Trigger data (Un\G36)	6-19
Trigger pointer (Un\G123)	6-28
Trigger setting value (Un\G37)	6-19

[W]

Wiring of external power supply connector	7-9
---	-----

Warranty

Please confirm the following product warranty details before using this product.

1. Gratis Warranty Term and Gratis Warranty Range

If any faults or defects (hereinafter "Failure") found to be the responsibility of Mitsubishi occurs during use of the product within the gratis warranty term, the product shall be repaired at no cost via the sales representative or Mitsubishi Service Company.

However, if repairs are required onsite at domestic or overseas location, expenses to send an engineer will be solely at the customer's discretion. Mitsubishi shall not be held responsible for any re-commissioning, maintenance, or testing on-site that involves replacement of the failed module.

[Gratis Warranty Term]

The gratis warranty term of the product shall be for one year after the date of purchase or delivery to a designated place.

Note that after manufacture and shipment from Mitsubishi, the maximum distribution period shall be six (6) months, and the longest gratis warranty term after manufacturing shall be eighteen (18) months. The gratis warranty term of repair parts shall not exceed the gratis warranty term before repairs.

[Gratis Warranty Range]

- (1) The range shall be limited to normal use within the usage state, usage methods and usage environment, etc., which follow the conditions and precautions, etc., given in the instruction manual, user's manual and caution labels on the product.
- (2) Even within the gratis warranty term, repairs shall be charged for in the following cases.
 1. Failure occurring from inappropriate storage or handling, carelessness or negligence by the user. Failure caused by the user's hardware or software design.
 2. Failure caused by unapproved modifications, etc., to the product by the user.
 3. When the Mitsubishi product is assembled into a user's device, Failure that could have been avoided if functions or structures, judged as necessary in the legal safety measures the user's device is subject to or as necessary by industry standards, had been provided.
 4. Failure that could have been avoided if consumable parts (battery, backlight, fuse, etc.) designated in the instruction manual had been correctly serviced or replaced.
 5. Failure caused by external irresistible forces such as fires or abnormal voltages, and Failure caused by force majeure such as earthquakes, lightning, wind and water damage.
 6. Failure caused by reasons unpredictable by scientific technology standards at time of shipment from Mitsubishi.
 7. Any other failure found not to be the responsibility of Mitsubishi or that admitted not to be so by the user.

2. Onerous repair term after discontinuation of production

(1) Mitsubishi shall accept onerous product repairs for seven (7) years after production of the product is discontinued.

Discontinuation of production shall be notified with Mitsubishi Technical Bulletins, etc.

(2) Product supply (including repair parts) is not available after production is discontinued.

3. Overseas service

Overseas, repairs shall be accepted by Mitsubishi's local overseas FA Center. Note that the repair conditions at each FA Center may differ.

4. Exclusion of loss in opportunity and secondary loss from warranty liability

Regardless of the gratis warranty term, Mitsubishi shall not be liable for compensation of damages caused by any cause found not to be the responsibility of Mitsubishi, loss in opportunity, lost profits incurred to the user by Failures of Mitsubishi products, special damages and secondary damages whether foreseeable or not, compensation for accidents, and compensation for damages to products other than Mitsubishi products, replacement by the user, maintenance of on-site equipment, start-up test run and other tasks.

5. Changes in product specifications

The specifications given in the catalogs, manuals or technical documents are subject to change without prior notice.

Microsoft, Windows, Windows Vista, Windows NT, Windows XP, Windows Server, Visio, Excel, PowerPoint, Visual Basic, Visual C++, and Access are either registered trademarks or trademarks of Microsoft Corporation in the United States, Japan, and other countries.

Intel, Pentium, and Celeron are either registered trademarks or trademarks of Intel Corporation in the United States and other countries.

Ethernet is a trademark of Xerox Corp.

All other company names and product names used in this manual are either trademarks or registered trademarks of their respective companies.

SPREAD

Copyright (C) 1997 Farpoint Technologies, Inc.

SH(NA)-080793ENG-C(1505)MEE

MODEL: Q64AD2DA-U-SY-E

MODEL CODE: 13JZ25

MITSUBISHI ELECTRIC CORPORATION

HEAD OFFICE : TOKYO BUILDING, 2-7-3 MARUNOUCHI, CHIYODA-KU, TOKYO 100-8310, JAPAN
NAGOYA WORKS : 1-14, YADA-MINAMI 5-CHOME, HIGASHI-KU, NAGOYA, JAPAN

When exported from Japan, this manual does not require application to the
Ministry of Economy, Trade and Industry for service transaction permission.

Specifications subject to change without notice.