



INVERTER

Front cover for plug-in option

FR-A7NL E kit cover SC

INSTRUCTION MANUAL

Thank you for choosing this Mitsubishi Inverter plug-in option.

This Instruction Manual gives handling information and precautions for use of this equipment. Incorrect handling might cause an unexpected fault. Before using the equipment, please read this manual carefully to use the equipment to its optimum.

Please forward this manual to the end user.

SAFETY INSTRUCTIONS



While power is ON or for some time after power-OFF, do not touch the inverter as it will be extremely hot. Doing so can cause burns.



The product must be transported in correct method that corresponds to the weight. Failure to do so may lead to injuries. Special attention must be paid to the edges of the product.



Foreign conductive objects must be prevented from entering the inverter. That includes screws and metal fragments or other flammable substances such as oil.

1 PRE-OPERATION INSTRUCTIONS

1.1 Unpacking and Product Confirmation



Take the front cover for plug-in option out of the package and confirm that the product is as you ordered and intact. This product is a front cover for plug-in option dedicated for the FR-E700-SC series (Safety stop function model). This product is used to mount the plug-in option FR-A7NL (LONWORKS communication) to the inverter. When mounting this product to the inverter, use the following items: the plug-in option FR-A7NL, the terminal block of the plug-in option FR-A7NL, and the enclosed items of this product.

CAUTION

- Instead of the standard inverter front cover, fit this front cover of the plug-in option for the operation.
- The mounting screws and the LED display cover supplied with the plug-in option FR-A7NL are not used.

1.1.1 Product confirmation

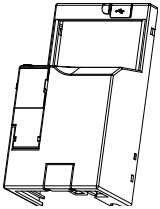
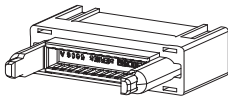
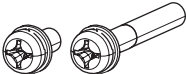
Check the enclosed items.

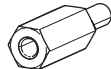
Front cover for plug-in option..... 1 (Refer to page 4, 6.) 	Junction connector 1 (Refer to page 4, 6.) 	M3 mounting screw (Long) (M3 × 20mm) 1 (Short) (M3 × 6mm)..... 1 (Refer to page 4, 6.) 
	Spacer for plug-in option mounting ... 1 (Refer to page 4, 6.) 	Hexagon spacer..... 1 (Refer to page 4, 6.) 

- Echelon®, LONWORKS®, LonMaker®, LONMARK® and Neuron® are registered trademarks of Echelon Corporation in the U.S.A. and other countries.
Company and product names herein are the trademarks and registered trademarks of their respective owners.

2 INSTALLATION AND WIRING

2.1 Installation Procedure

The FR-E700-SC (safety stop function model) series has one connection connector for the plug-in option.

CAUTION

- Always perform wiring to the main circuit terminals and control circuit terminals before mounting the plug-in option. Wiring cannot be performed after mounting the plug-in option.
- When mounting the plug-in option, do not let wires get caught in the plug-in option or the spacer for option mounting. If a wire gets caught, the inverter and the plug-in option may be damaged.
- When the inverter cannot recognize that the plug-in option is mounted due to improper installation, etc., "E. I" (option alarm) is displayed.
- Take care not to drop a mounting screws during mounting and removal.
- Pull out the plug-in option straight to remove. Otherwise, the connector may be damaged.

REMARKS

- Because the voltage class, model name and serial number (only voltage class is labeled for FR-E720-5.5K (FR-E720-240), FR-E740-5.5K (FR-E740-120) or higher) are written on the PU cover, replace the PU cover of the plug-in option with the removed PU cover of the inverter.

7 INSTALLATION AND WIRING

● For FR-E720-3.7K (FR-E720-175) or lower and FR-E740-7.5K (FR-E740-170) or lower

- (1) Remove the front cover from the inverter. (For removing the front cover, refer to the FR-E700 Instruction Manual.)
- (2) Remove the PU cover from the front cover. Open the PU cover with a driver, etc. and remove it in the direction of arrow as shown below.

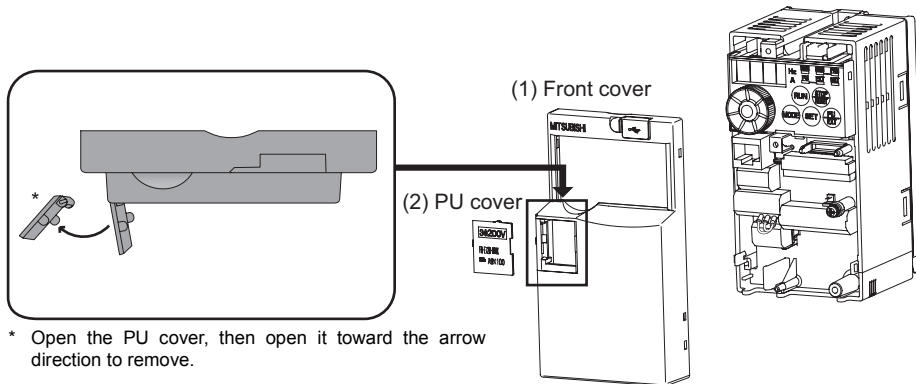

- (3) Fit the spacer for plug-in option mounting, the hexagon spacer, and the junction connector into their designated positions shown in the diagram on the next page. Fit the junction connector along the guide of the connector of the inverter and insert it as far as it goes.
- (4) Fit the connector of the plug-in option along the guide of the junction connector and insert it as far as it goes.
- (5) Fix the plug-in option securely by using the supplied mounting screw (short) to the upper screw hole and the other supplied mounting screw (long) to the lower screw hole of the plug-in option. If the screw holes do not line up, the connector may not have been plugged properly. Check for loose plugging.
- (6) Remove the PU cover provided on the front cover for plug-in option and install the other PU cover, which was removed in (2).
- (7) Mount the already wired terminal block to the plug-in option.

(8) Mount the front cover for plug-in option to the inverter.

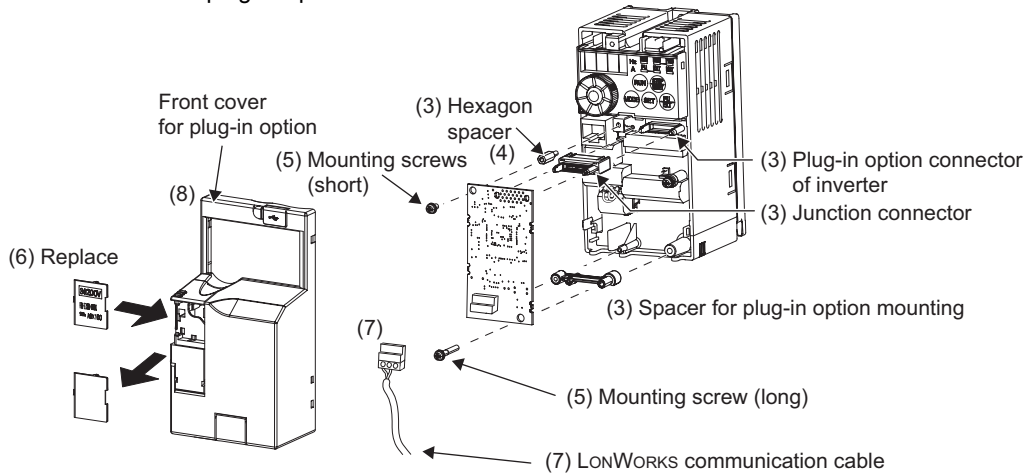

7 INSTALLATION AND WIRING

- For FR-E720-5.5K (FR-E720-240) or higher and FR-E740-11K (FR-E740-230) or higher

(1) Remove the front covers 1 and 2 from the inverter. (For removing the front cover, refer to the FR-E700 Instruction Manual.)

(2) Remove the PU cover from the front cover 2. For removing the PU cover, refer to *page 4*.

(3) Mount the front cover 1 to the inverter.

(4) Fit the spacer for plug-in option mounting, the hexagon spacer, and the junction connector into their designated positions shown in the diagram on the next page. Fit the junction connector along the guide of the connector of the inverter and insert it as far as it goes.

(5) Fit the connector of the plug-in option along the guide of the junction connector and insert it as far as it goes.

(6) Fix the plug-in option securely by using the supplied mounting screw (short) to the upper screw hole and the other supplied mounting screw (long) to the lower screw hole of the plug-in option. If the screw holes do not line up, the connector may not have been plugged properly. Check for loose plugging.

(7) Remove the PU cover provided on the front cover for plug in option and mount the other PU cover, which was removed in (2).

(8) Mount the already wired terminal block to the plug-in option.

Pass the LONWORKS communication cable over the front cover 1 of the inverter. (Refer to the finished installation figure in the next page.) If a LONWORKS communication cable is passed through underneath the front cover 1, the bending radius of the cable shortens, stressing the cable.

(9) Mount the front cover for plug-in option to the inverter.

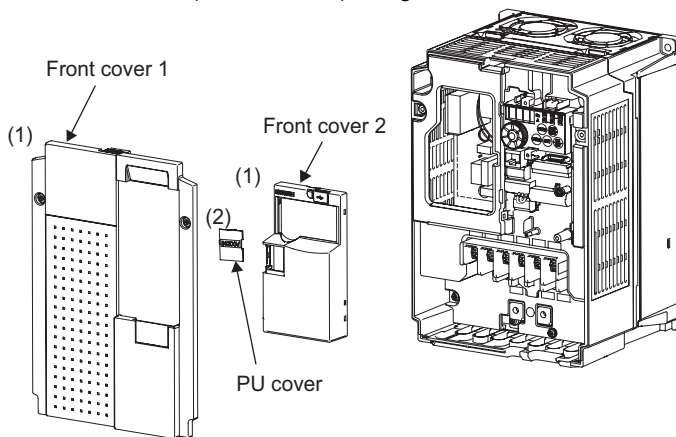

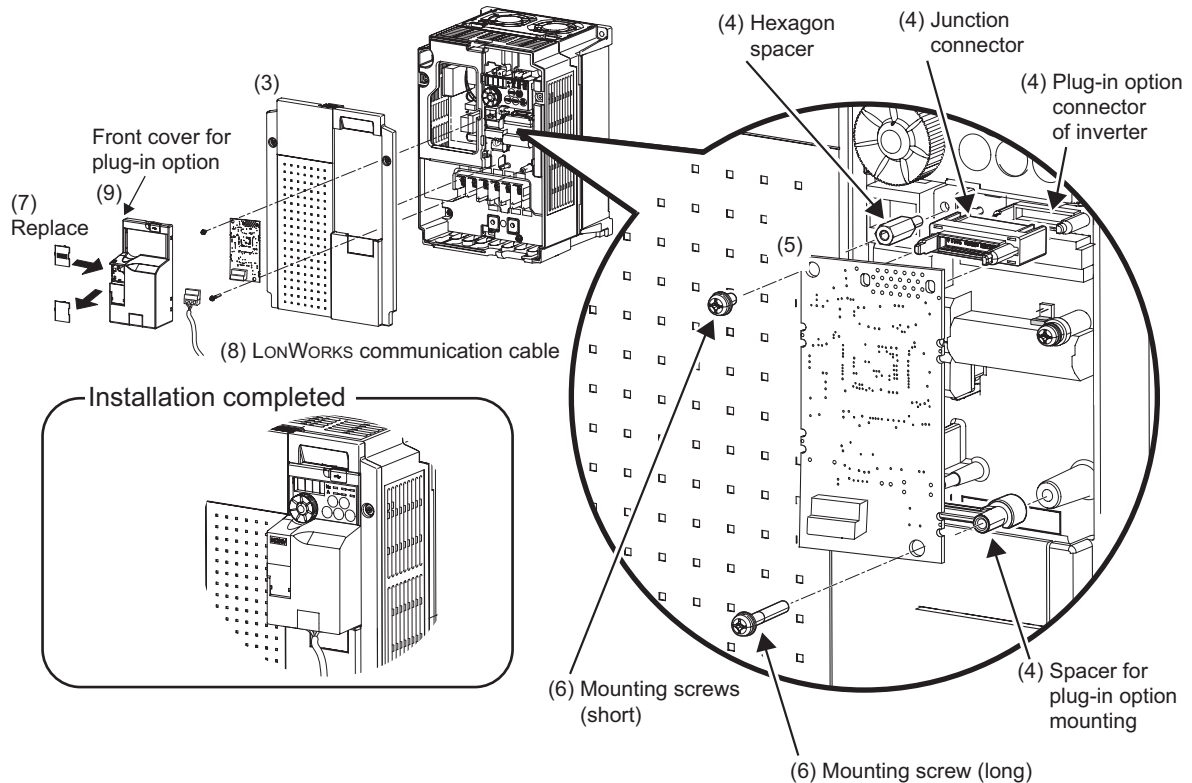

2.2 Wiring

CAUTION

- Always perform wiring to the main circuit terminals and control circuit terminals before mounting the plug-in option. Wiring cannot be performed after mounting the option.

POINT

If a hook of the front cover for plug-in option impedes wiring, cut the hook off and perform wiring.

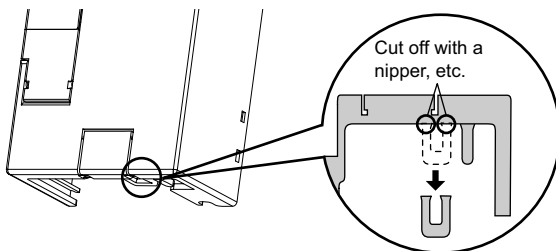

Cut off a hook at the bottom of the option cover.
(Cut off so that no portion is left.)

REMARKS

- The protective structure (JEM1030) is the open type (IP00).

3 LONWORKS communication function

When using FR-A7NL with the FR-E700-SC series (Safety stop function), specifications of parameter, I/O signal, alarm, monitor, etc. are different from those stated in the FR-A7NL manual.
Refer to the FR-E700-SC series(Safety stop communication) manual for these specifications.

REVISIONS

*The manual number is given on the bottom left of the back cover.

Print Date	*Manual Number	Revision
Oct. 2010	IB(NA)-0600449ENG-A	First edition

INVERTER



IB(NA)-0600449ENG-A(1010) MEE

Printed in Japan

Specifications subject to change without notice.