



**mitsubishi
ELECTRIC**

Changes for the Better

for a greener tomorrow



INVERTER

Model

FR-F700PJ



GREAT ENERGY SAVING WITH THE COMPACT BODY

F700PJ

IM & IPM



Premium high-efficiency IPM motor
MM-EFS series compatible

The Easy and Compact Inverter FR-F700PJ for Energy Saving

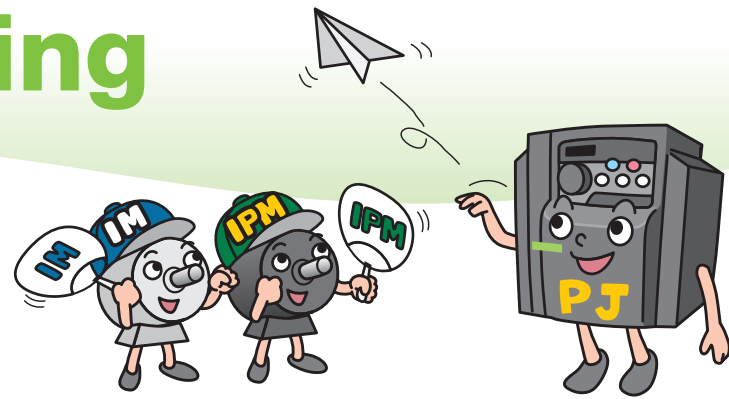

1 Suitable for Both the General-purpose Motor (Three-Phase Induction Motor) and the IPM Motor

(1) The F700PJ series for both a general-purpose motor (IM) and an IPM motor (IPM)

- The IM drive setting can be switched to IPM drive setting by only one setting "12" (MM-EFS) in the parameter **Pr1**. (Refer to page 77 for details.)
Never drive an IPM motor in the IM drive setting.
- One spare F700PJ inverter is enough for the two types of motors (IM and IPM); the number of required spare inverters is reduced by half.
- A push on the setting dial in the monitor mode brings up the control setting (IM, IPM).

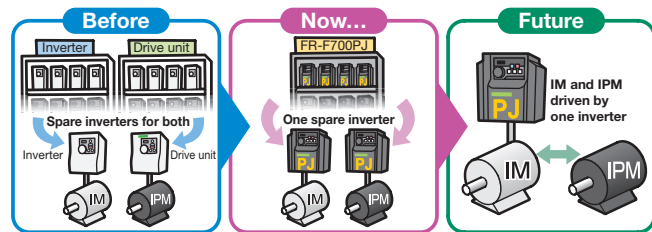

(2) Simple and reliable transition from IM to IPM

There is no need to replace the whole system at once; replace the inverters first, then replace the motors. When the budget is limited, equipment investment can be made over several stages.

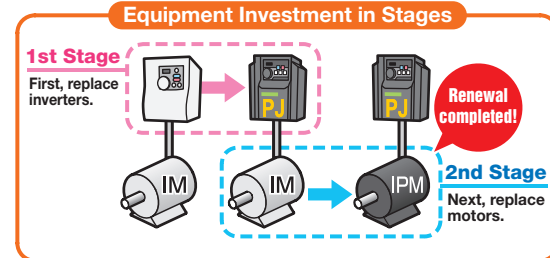

(3) What is an IPM motor?

An IPM motor is a synchronous motor with strong permanent magnets embedded in its rotor.

Why is an IPM motor more efficient?

- No current flows to the rotor (secondary side), and no secondary copper loss is generated.
- Magnetic flux is generated with permanent magnets, and less motor current is required.
- Embedded magnets provide reluctance torque*, which can be used for driving.

*: Reluctance torque occurs due to magnetic imbalance in the rotor.

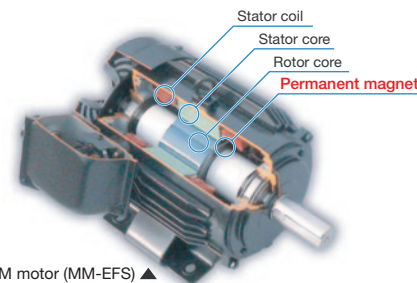
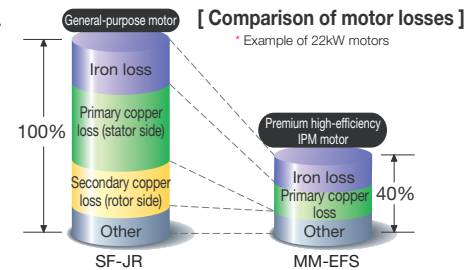

Motor structure (section view)	
IPM motor (synchronous motor)	General-purpose motor (induction motor)
<p>Stator coil (three-phase coil)</p> <p>Stator core</p> <p>Shaft</p> <p>Rotor core</p> <p>Permanent magnets</p> <p>*Example of 6-pole motor</p>	<p>Stator coil (three-phase coil)</p> <p>Stator core</p> <p>Shaft</p> <p>Rotor core</p> <p>Rotor conductor (copper or aluminum)</p>

2 Inverter Control for Energy Saving

(1) Energy saving with speed control

The consumed power of a variable-torque load, such as fans, pumps, and blowers, is proportional to the cube of its rotation speed. This means that controlling the rotation speed to adjust the air volume can lead to energy saving.

[Example of blower operation characteristic]

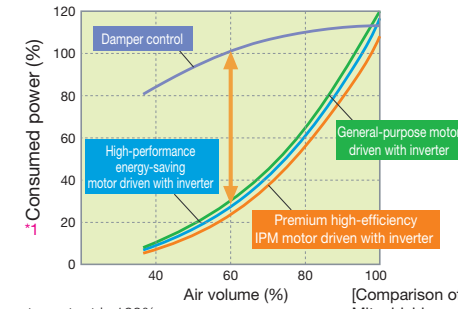

*1: Rated motor output is 100%. [Comparison of Mitsubishi products]

(2) Energy saving with Optimum excitation control (General-purpose motors)

The optimum excitation control achieves the highest motor efficiency. Further energy saving can be achieved for applications such as fans and pumps with variable load torque. (Refer to page 37 for the details.)

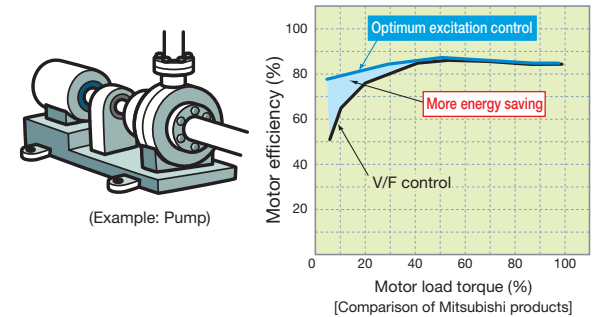

(3) To save more energy – the IPM motor control (MM-EFS series) is now available

High efficiency achieved with IPM motors

The IPM motors that have permanent magnets embedded in their rotors are even more efficient than the high-performance energy-saving motors.

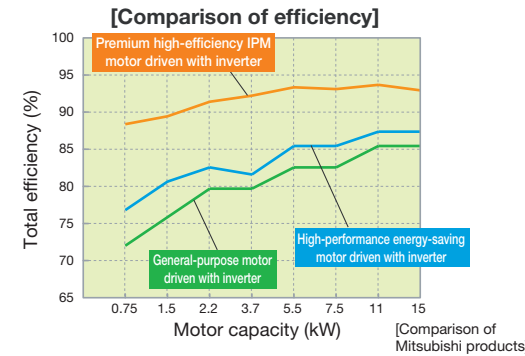

Smooth replacement from a general-purpose motor (with the same installation size)

The frame number of the MM-EFS is the same (same size) as the Mitsubishi general-purpose motors (4-pole SF-JR/SF-HR series). Replacement is easy as the installation sizes are compatible.

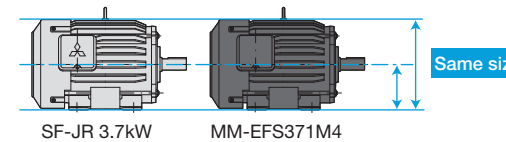

IE4-equivalent efficiency level

The premium high-efficiency IPM motor "MM-EFS series" provides efficiency that is equivalent to IE4 (super premium efficiency), the highest efficiency class*2.

*2: As of October 2012

IEC 60034-30 Efficiency class	Efficiency of Mitsubishi motors	
	General-purpose motor	IPM motor
IE4 (super premium efficiency)*3	—	Premium high-efficiency IPM (MM-EFS)
IE3 (premium efficiency)	Super line premium series (SF-PR)	—
IE2 (high efficiency)	Super line eco series (SF-HR)	—
IE1 (standard efficiency)	Super line series (SF-JR)	—
Below the class	—	—

*3: The details of IE4 can be found in IEC 60034-31.

(4) Check the energy saving effect at a glance

Energy saving monitor is available. The energy saving effect can be checked using an operation panel, output terminal (terminal FM), or network.



Example of the monitor display for power saving

[List of monitored items for energy saving]	
Power saving monitor (kW)	Power saving rate average value (%)
Power saving rate (%)	Power cost saving average value (yen)
Power saving amount (kWh)	Annual power saving amount (kWh)
Power cost saving (yen)	Annual power cost saving (yen)
Power saving average value (kW)	

The output power amount measured by the inverter can be output in pulses. The cumulative power amount can be easily checked.*4

*4: This function cannot be used as a meter to certify billings.

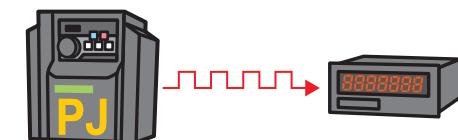

Features	1
Connection example	7
Standard specs.	8
Outline dimensions	10
Terminal connection diagrams	13
Terminal specs.	
Operation panel	15
Parameter unit	
FR Configurator	
Parameter list	19
Parameter details	26
Protective functions	46
Options and peripheral devices	47
Precaution on selection and operation	58
Precautions on peripheral device selection	
Compatible motor	62
IPM motor control	66
Difference and compatibility with FR-F500 (L) series	69
Warranty	74
Global FA centers	

3 Wire and Space Saving

(1) A lineup of Filterpack models available

•The power factor improving DC reactor, common mode choke (line noise filter), and capacitive filter (radio noise filter) are all essential for air conditioning applications, and all of these are included in a Filterpack. The Filterpack inverter models (FR-F7□0PJ-□F) are also available. The option wiring, which was necessary in the past, is no longer required.

•A Filterpack allows flexible installation and various layouts in the enclosure. Smaller space is required for installation.
 •Less wiring and smaller space also enable compliance with the Harmonic Suppression Guidelines, **the Architectural Standard Specifications (Electrical Installation)**, and **the Architectural Standard Specifications (Machinery Installation) (2013 revisions)** in Japan.

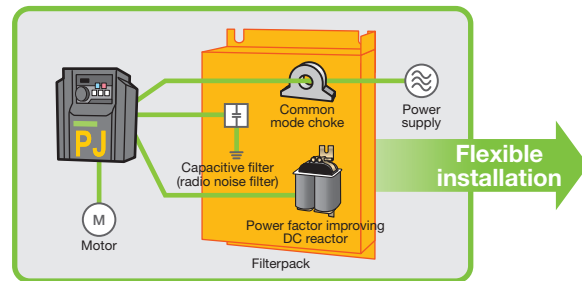

Installation method	Installation area reduced by*1
Back of the panel	Approx. 72% With FR-F740PJ-3.7KF
Side of the panel	Approx. 84% With FR-F740PJ-3.7KF 200 mm or less depth at all capacities

*1: The area required for the separate installation of power factor improving DC reactor, common mode choke (line noise filter), and capacitive filter (radio noise filter) with clearance around them.

(2) Space saving by the side-by-side installation

•Side-by-side installation is possible*2 and requires less space. A DIN rail installation attachment (FR-UDA□□) option can be installed.

*2: Keep the surrounding air temperature of the inverter at 40 °C maximum. Side-by-side installation is not available for Filterpacks.



4 Easy Operation and Maintenance

(1) Quick setting using the setting dial

•The adaptable scroll speed setting dial allows for quick jumps or precise increments based on turning speed.
 •The non-slip treatment was applied to the setting dial for easier turning.



(2) Automatic parameter setting for specific applications

- Simple parameter setting (Pr.79 Operation mode selection)
- Communication setting for Mitsubishi HMI (GOT)
- Rated frequency change (60Hz → 50Hz)

(3) Spring clamp terminals (control circuit terminals)

Spring clamp terminals*1 are adopted as control circuit terminals. Spring clamp terminals are highly reliable and can be easily wired.

*1: The control circuit terminals are screw terminals.

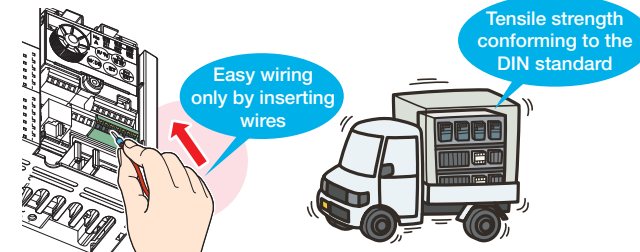

(4) Longer life parts

•The service life of the cooling fans is now 10 years*2. The service life can be further extended by ON/OFF control of the cooling fan.
 •Capacitors with a design life of 10 years*2*3 are adapted. (Surrounding air temperature of 105°C for 5000 hours). With these capacitors, the service life of the inverter is further extended.

*2: Surrounding air temperature: Annual average of 40°C (free from corrosive gas, flammable gas, oil mist, dust and dirt). The design life is a calculated value and is not a guaranteed product life.

*3: Output current: 80% of the inverter rating.

(5) The leading-edge life diagnosis function

•The degree of deterioration of the main circuit capacitor, control circuit capacitor, and inrush current limit circuit can be diagnosed on the monitor.
 •Using the self-diagnosis function, the part life warning*4 can be output. With these warnings, the self-diagnosis function prevents troubles from occurring.

*4: A warning is output when any of the main circuit capacitor, control circuit capacitor, inrush current limit circuit, and cooling fan reaches its specified output level.

(6) Enhanced communication function

•The Mitsubishi inverter protocol and Modbus-RTU are selectable.
 •The speed of RS-485 communication has been improved. (Communication at 38.4kbps is available.)

5 Optimum for Fan and Pump Applications

(1) Enhanced PID control

- To save energy in low-speed operation: PID output shutoff (sleep) function
- To shorten the start-up time of PID control: PID automatic switchover function
- For air conditioning applications: Forward/reverse rotation switching by external signals
- To use various types of detectors: PID set point and measured value outputs in voltage (0 to 5V / 0 to 10V) and current (4 to 20mA)

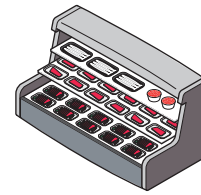

(Example: Water-cooling pump for a showcase)

(2) Regeneration avoidance function

The operation frequency is automatically increased to prevent the regenerative overvoltage fault from occurring. This function is useful when a load is forcibly rotated by another fan in the duct.

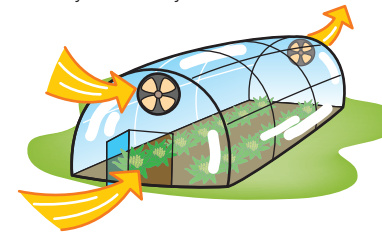

(3) Automatic restart after instantaneous power failure function / flying start function

After an instantaneous power failure, the operation is re-startable from the coasting motor speed. Even if the rotation direction has been forcibly reversed, the operation can be smoothly restarted in the original direction.

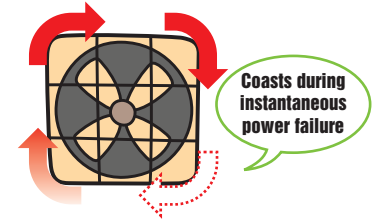

Example

The fan is rotated by the external force.



We need smooth start-up of the motor.

Use the flying start function.

The motor can be started smoothly even after the motor was rotated by the external force (coasting). This function can be set enabled by changing Pr.57 setting.

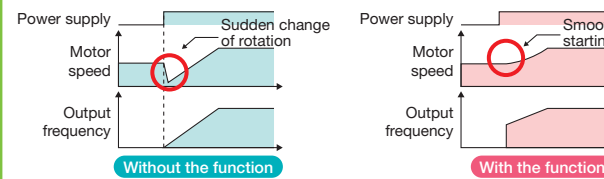

Parameters to adjust the acceleration time at a restart (Pr.611), to detect the fan rotation direction (Pr.299), etc. are also available.



We need continuous operations without being interrupted by the overvoltage protective function (E.O.V).

Use the regeneration avoidance function.

When the external force accelerates rotation of the running motor (regeneration), the motor may trip due to the overvoltage. The regeneration avoidance function is available to increase the frequency and avoid the regenerative condition. This function can be set enabled by changing Pr.822 setting.

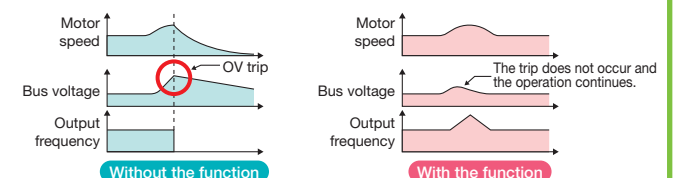

Parameters to start the regeneration avoidance operation (Pr.883) and to adjust the response level (Pr.886) are also available.

- Offers a selection of small frames
- Offers a line-up of safety contactors
- Supports small loads (auxiliary contact)
- Supports many international regulations as standard



Refer to page 65 for the selection.

6 Application Example

Great energy saving effect obtained in medium airflow

(When the electricity cost is 14 yen/kWh, and the CO₂ emission is [1,000 kWh 0.555 ton - CO₂ emission])

Condition

Operation patterns

Water-cooling pump for a showcase

Commercial power supply (valve) + General-purpose motor (SF-JR)
Inverter + General-purpose motor (SF-JR)

[Units to drive]

- Water-cooling pump: 3.7 kW × 1 unit
- Fans for the cooling tower: 1.5 kW × 1 unit
- Freezer: 11 kW × 3 unit, 5.5 kW × 2 unit, 3.7 kW × 1 unit, 3.0 kW × 1 unit

Water volume (%) graph: Spring, Summer, Fall, Winter. 8760 hours/year.

●With commercial power supply: Approx. 0.15 million kWh, Approx. 2.17 million yen

●With inverter: Approx. 0.14 million kWh, Approx. 1.9 million yen

Air conditioning in a Mitsubishi plant

Inverter + General-purpose motor (SF-JR)
Inverter + IPM motor (MM-EFS)

[Units to drive]

- Ventilator: 0.75 kW × 3 unit, 1.5 kW × 1 unit, 2.2 kW × 3 unit
- Air conditioner: 15 kW × 1 unit, 18.5 kW × 1 unit, 30 kW × 2 unit

Air volume (%) graph: 0-24 hours. 5475 hours/year.

●With general-purpose motor: Approx. 0.25 million kWh, Approx. 3.44 million yen

●With IPM motor: Approx. 0.22 million kWh, Approx. 3.02 million yen

Air conditioning in a building

Inverter + General-purpose motor (SF-JR)
Inverter + IPM motor (MM-EFS)

[Units to drive]

- Fans for air conditioning: 5.5 kW × 10 unit, 7.5 kW × 10 unit, 3.7 kW × 100 unit

Air volume (%) graph: 0-24 hours. 4745 hours/year.

●With general-purpose motor: Approx. 2.39 million kWh, Approx. 33.42 million yen

●With IPM motor: Approx. 2.1 million kWh, Approx. 29.43 million yen

●Annual energy saving effect (differences in the amount and cost): Approx. 0.019 million kWh

Approx. 0.27 million yen

●Annual CO₂ emission reduction: Approx. 0.019 million kWh

10.7 tons

●Annual energy saving effect: Approx. 0.03 million kWh

Approx. 0.42 million yen

●Annual CO₂ emission reduction: Approx. 0.03 million kWh

16.7 tons

●Annual energy saving effect: Approx. 0.28 million kWh

Approx. 3.99 million yen

●Annual CO₂ emission reduction: Approx. 0.28 million kWh

158 tons

(Annual) energy saving effect produced by replacing to IPM motors driven with inverters

Your best assistant — Mitsubishi inverter software

●IPM energy savings simulation file

The IPM energy savings simulation file calculates the energy saving effect and CO₂ reduction rate achieved by replacing commercial power supply (damper/valve control) operation with IPM motor operation by inverter. This file requires inputs of motor capacity, quantity, air volume, operating time, etc.

IPM energy savings simulation file

●FR Configurator (FR-SW3-SETUP-WE) (Option)

Support tool for the inverter operations from start-up to maintenance.

Line Up

●Inverter

F R - F 7 4 0 P J - 3.7K

Symbol	Voltage class
2	200 V class
4	400 V class

Symbol	Inverter capacity
0.4K to 15K	Represents the capacity (kW).

Symbol	Filterpack
None	No
F	Yes*

Power supply specification	Inverter model	0.4	0.75	1.5	2.2	3.7	5.5	7.5	11	15
Three-phase 200 V	FR-F720PJ-□K FR-F720PJ-□KF	●	●	●	●	●	●	●	●	●
Three-phase 400 V	FR-F740PJ-□K FR-F740PJ-□KF	●	●	●	●	●	●	●	●	●

● : To be released

■Precautions

- Never drive an IPM motor in the IM drive setting.
- Use the same IPM motor capacity as the inverter capacity.
- For IPM motor, use an MM-EFS or MM-EF series motor. Please contact us regarding a combination with other manufacturer's IPM motor.

*The inverter with Filterpack consists of an inverter and a Filterpack. The inverter carries the rating plate, "FR-F7 □0PJ-□KF" and the Filterpack carries the rating plate "FR-BFP2-□K".

Compatible with UL, cUL, EC Directives (CE marking)

●IPM motors and Filterpacks are not compatible with the above regulations and directives.

Being RoHS compliant, the FR-F700PJ series inverters are friendly to people and to the environment.

●Premium high-efficiency IPM motor

M M - E F S 7 1M 4

Symbol	Output	Symbol	Output
7	0.75 kW	55	5.5 kW
15	1.5 kW	75	7.5 kW
22	2.2 kW	11K	11 kW
37	3.7 kW	15K	15 kW

Symbol	Rated speed*1
1M	1500 r/min

Symbol	Voltage class
None	200 V
4	400 V

Symbol	Specification*2	Symbol	Specification*2
Q	Class B	P1	Outdoor-type

*1: Also applicable to an application with the rated speed of 1800r/min.
*2: The outdoor-type and class B are semi-standard models. Please contact your sales representative for a special specification such as the long-axis type, flange shape, and salt-proof type.

Rated output (kW)	0.75	1.5	2.2	3.7	5.5	7.5	11	15
Motor model	7	15	22	37	55	75	11K	15K
200 V class	MM-EFS□1M	●	●	●	●	●	●	●
400 V class	MM-EFS□1M4	●	●	●	●	●	●	●

● : To be released

■Precautions

- MM-EFS series IPM motors cannot be driven with commercial power supply.
- The total wiring length for an IPM motor should be 100 m or less.
- Only one IPM motor can be connected to an inverter.

5

6

Features
Connection example
Standard specs.
Outline dimensions
Terminal connection diagrams
Terminal specs.
Operation panel
Parameter unit
FR Configurator
Parameter list
Parameter descriptions
Protective functions
Options
Precautions
Motor
IPM motor control
Compatibility
Warranty

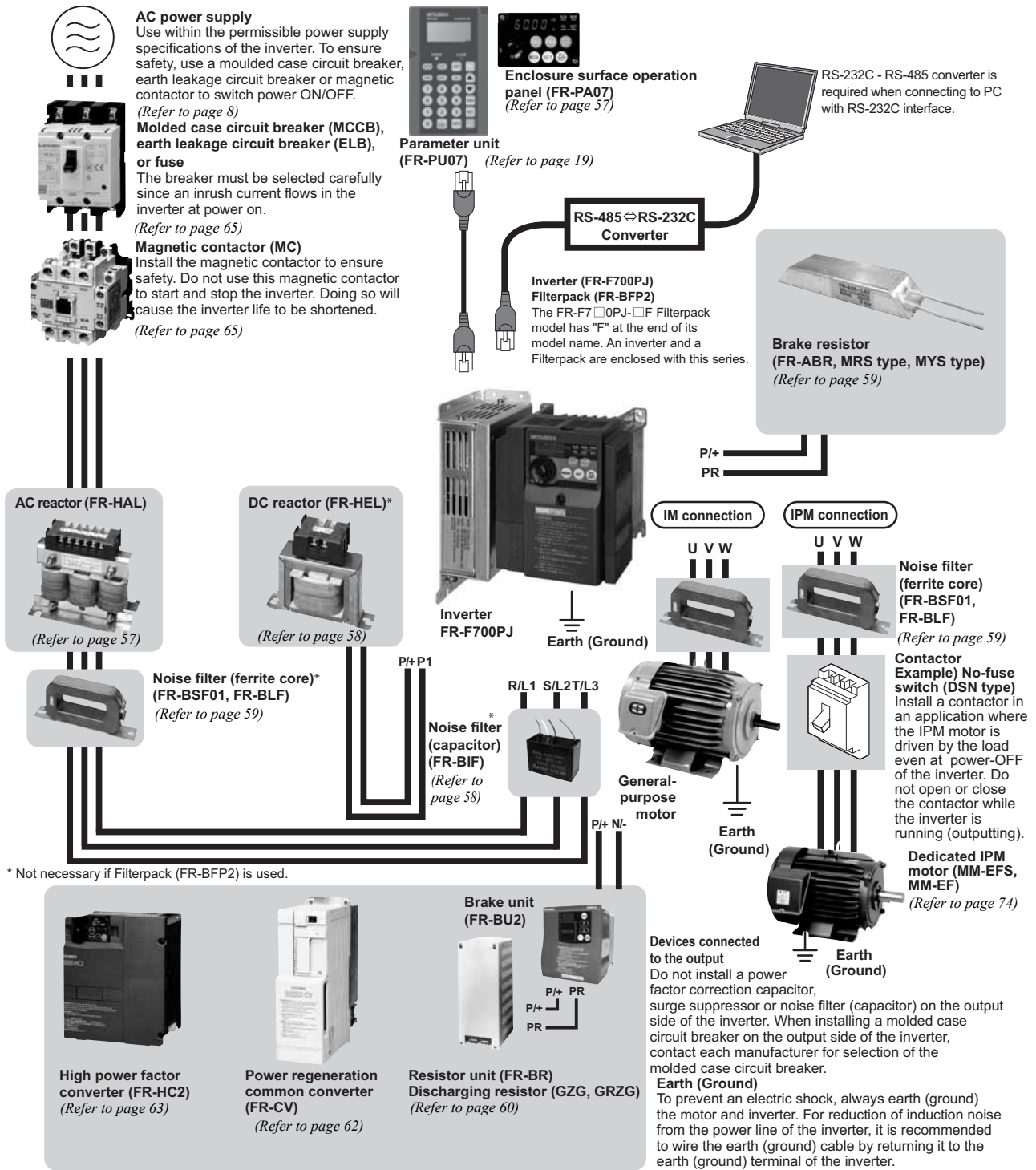

NOTE

- The life of the inverter is influenced by surrounding air temperature. Use the product within the permissible surrounding air temperature. This must be noted especially when the inverter is installed in an enclosure.
(Refer to chapter 1 of the Instruction Manual (Applied))
- Wrong wiring might lead to damage of the inverter. The control signal lines must be kept fully away from the main circuit to protect them from noise. (Refer to page 14)
- Do not install a power factor correction capacitor, surge suppressor or noise filter (capacitor) on the inverter output side. This will cause the inverter to trip or the capacitor and surge suppressor to be damaged. If any of the above devices are connected, immediately remove them.
- Electromagnetic wave interference
The input/output (main circuit) of the inverter includes high frequency components, which may interfere with the communication devices (such as AM radios) used near the inverter. In this case, install the FR-BIF optional EMC filter (capacitor) (for use in the input side only) or FR-BSF01 or FR-BLF noise filter (ferrite core) to minimize interference.
(Refer to chapter 3 of the Instruction Manual (Applied))
- Refer to the Instruction Manual of each option and peripheral devices for details of peripheral devices.
- An IPM motor cannot be driven by the commercial power supply.
- An IPM motor is a motor with permanent magnets embedded inside. High voltage is generated at the motor terminals while the motor is running. Before closing the contactor at the output side, make sure that the inverter power is ON and the motor is stopped.

Rating

● Three-phase 200V power supply

		Inverter								
Model FR-F720PJ-□K		0.4	0.75	1.5	2.2	3.7	5.5	7.5	11	15
Applicable general-purpose motor capacity (kW)*1		0.4	0.75	1.5	2.2	3.7	5.5	7.5	11	15
Output	Rated capacity (kVA)*2	1.0	1.6	2.7	3.8	6.3	9.1	12.1	17.1	22.1
	Rated current (A)	2.5	4.2	7.0	10.0	16.5	23.8	31.8	45	58
	Overload current rating*3	120% 60s, 150% 0.5s (inverse-time characteristics)								
Power supply	Rated voltage*4	Three-phase 200 to 240V								
	Rated input AC voltage/frequency	Three-phase 200 to 240V 50Hz/60Hz								
	Permissible AC voltage fluctuation	170 to 264V 50Hz/60Hz								
	Permissible frequency fluctuation	±5%								
	Power supply capacity (kVA)*5	Without Filterpack	1.2	2.1	4.0	5.0	8.8	12.0	17.0	20.0
	With Filterpack	0.8	1.2	2.6	3.4	5.5	8.4	11.0	16.0	19.0
Protective structure (JEM 1030)		Enclosed type (IP20)*6								
Cooling system		Self-cooling			Forced air cooling					
Approximate mass(kg)		0.8	1.0	1.4	1.4	1.8	3.6	3.6	6.5	6.5

		Filterpack								
Model FR-BFP2-□K		0.4	0.75	1.5	2.2	3.7	5.5	7.5	11	15
Approximate mass(kg)		1.3	1.4	2.0	2.2	2.8	3.8	4.5	6.7	7.0
Power factor improving reactor		Install the DC reactor in the DC side. 93% to 95% of power supply power factor under 100% load (94.4% *7)								
EMC filter	Common mode choke	Install a ferrite core on the input side								
	Capacitive filter	About 4mA of capacitor leakage current*8								
Protective structure (JEM 1030)		Open type (IP00)								

● Three-phase 400V power supply

		Inverter								
Model FR-F740PJ-□K		0.4	0.75	1.5	2.2	3.7	5.5	7.5	11	15
Applicable general-purpose motor capacity (kW)*1		0.4	0.75	1.5	2.2	3.7	5.5	7.5	11	15
Output	Rated capacity (kVA)*2	0.9	1.7	2.8	3.8	6.2	9.1	12.4	17.5	22.5
	Rated current (A)	1.2	2.2	3.7	5.0	8.1	12.0	16.3	23.0	29.5
	Overload current rating*3	120%60s, 150% 0.5s (inverse-time characteristics)								
Power supply	Rated voltage*4	Three-phase 380 to 480V								
	Rated input AC voltage/frequency	Three-phase 380 to 480V 50Hz/60Hz								
	Permissible AC voltage fluctuation	325 to 528V 50Hz/60Hz								
	Permissible frequency fluctuation	±5%								
	Power supply capacity (kVA)*5	Without Filterpack	1.1	2.2	4.2	4.8	8.6	12.0	17.0	20.0
	With Filterpack	0.7	1.3	2.7	3.3	5.4	8.5	11.0	16.0	19.0
Protective structure (JEM 1030)		Enclosed type (IP20) *6								
Cooling system		Self-cooling			Forced air cooling					
Approximate mass (kg)		1.3	1.3	1.4	1.5	1.5	3.3	3.3	6.0	6.0

		Filterpack								
Model FR-BFP2-H□K		0.4	0.75	1.5	2.2	3.7	5.5	7.5	11	15
Approximate mass (kg)		1.6	1.7	1.9	2.3	2.6	4.5	5.0	7.0	8.2
Power factor improving reactor		Install the DC reactor in the DC side. 93% to 95% of power supply power factor under 100% load (94.4% *7)								
EMC filter	Common mode choke	Install a ferrite core on the input side								
	Capacitive filter	About 8mA of capacitor leakage current *8								
Protective structure (JEM 1030)		Open type (IP00)								

- *1 The applicable motor capacity indicated is the maximum capacity applicable for use of the Mitsubishi 4-pole standard motor. To use a dedicated IPM motor, refer to page 74.
- *2 The rated output capacity assumes the following output voltages: 220V for the three-phase 200V and 440V for the three-phase 400V class.
- *3 The % value of the overload current rating indicated is the ratio of the overload current to the inverter's rated output current. For repeated duty, allow time for the inverter and motor to return to or below the temperatures under 100% load.
- *4 The maximum output voltage does not exceed the power supply voltage. The maximum output voltage can be changed within the setting range. However, the pulse voltage value of the inverter output side voltage remains unchanged at about $\sqrt{2}$ that of the power supply.
- *5 The power supply capacity varies with the value of the power supply side inverter impedance (including those of the input reactor and cables).
- *6 Open type (IP00) for Filterpack.
- *7 The values in parentheses are calculated with 1 fundamental frequency power factor according to the Year 2013 Standard specification for public constructions (electric installation works), published by the Ministry of Land, Infrastructure, Transport and Tourism in Japan.
- *8 The indicated leakage current is equivalent to one-phase of the three-phase three wire Δ connection cable.

Features
 Connection example
 Standard specs.
 Outline dimensions
 Terminal connection diagrams
 Terminal specs.
 Operation panel Parameter unit FR Configurator
 Parameter list
 Parameter descriptions
 Protective functions
 Options
 Precautions
 Motor
 IPM motor control
 Compatibility
 Warranty

Common Specification

Control specifications	Control method		High carrier frequency PWM control (V/F control)/Optimum excitation control/General-purpose magnetic flux vector control/IPM motor control
	Output frequency range		0.2 to 400Hz
	Frequency setting resolution	Analog input	0.06Hz/60Hz (terminals 2 and 4: 0 to 10V/10-bit) 0.12Hz/60Hz (terminals 2 and 4: 0 to 5V/9-bit) 0.06Hz/60Hz (terminal 4: 0 to 20mA/10-bit)
		Digital input	0.01Hz
	Frequency accuracy	Analog input	Within $\pm 1\%$ of the max. output frequency ($25^{\circ}\text{C} \pm 10^{\circ}\text{C}$)
		Digital input	Within 0.01% of the set output frequency
	Speed control range		V/F control 1:10, General-purpose magnetic flux vector control (during power driving) 1:60, IPM motor control 1:10
	Voltage/frequency characteristics		Base frequency can be set from 0 to 400Hz. Constant-torque/variable-torque pattern can be selected.
	Starting torque		General-purpose motor control (General-purpose magnetic flux vector control or slip compensation): 120% (at 1Hz) IPM motor control: 50%
	Torque boost		Manual torque boost
	Acceleration/deceleration time setting		0.1 to 3600s (acceleration and deceleration can be set individually), linear and S-pattern acceleration/deceleration modes are available.
	Regenerative braking torque		General-purpose motor control: 15% *1 IPM motor control: 5% (10% for 1.5kW or less)*1
	DC injection brake		General-purpose motor control: Operation frequency (0 to 120Hz), operation time (0 to 10s), operation voltage (0 to 30%) can be changed.
Stall prevention operation level		Operation current level can be set (0 to 150% variable). Whether to use the function or not can be set.	
Operation specifications	Frequency setting signal	Analog input	Two terminals Terminal 2: 0 to 10V and 0 to 5V are available Terminal 4: 0 to 10V, 0 to 5V, and 4 to 20mA are available
		Digital input	The signal is entered from the operation panel or parameter unit. Frequency setting increment can be set.
	Start signal		Forward and reverse rotation or start signal automatic self-holding input (3-wire input) can be selected.
	Input signal (five terminals)		The following signals can be assigned to <i>Pr. 178 to Pr.182 (input terminal function selection)</i> : multi-speed selection, remote setting, second function selection, terminal 4 input selection, JOG operation selection, PID control valid terminal, external thermal input, PU-External operation switchover, V/F switchover, output stop, start self-holding selection, forward rotation, reverse rotation command, inverter reset, PID forward/reverse action switchover, PU-NET operation switchover, External-NET operation switchover, command source switchover, inverter operation enable signal, PU operation external interlock, PID integral value reset.
	Operational functions		Maximum/minimum frequency setting, frequency jump operation, external thermal relay input selection, automatic restart after instantaneous power failure operation, forward/reverse rotation prevention, remote setting, second function, multi-speed operation, regeneration avoidance, slip compensation, operation mode selection, offline auto tuning function, PID control, computer link operation (RS-485), Optimum excitation control, power failure stop, speed smoothing control, Modbus-RTU
	Output signal		The following signals can be assigned to <i>Pr.190 and Pr.192 (output terminal function selection)</i> : inverter operation, up-to-frequency, overload alarm, output frequency detection, regenerative brake prealarm, electronic thermal relay function prealarm, inverter operation ready, output current detection, zero current detection, PID lower limit, PID upper limit, PID forward/reverse rotation output, fan alarm *2, heatsink overheat pre-alarm, deceleration at an instantaneous power failure, PID control activated, PID deviation limit, IPM motor control *3, PID output interruption, pulse train output of output power, during retry, life alarm, average current value monitor, remote output, alarm output, fault output, fault output 3, and maintenance timer alarm.
	Open collector output (one terminal)		
Relay output (one terminal)			
Indication	Operation panel	Operating status	The following operating status can be displayed: output frequency, output current (steady), output voltage, frequency setting, cumulative energization time, actual operation time, converter output voltage, regenerative brake duty, electronic thermal relay function load factor, output current peak value, converter output voltage peak value, motor load factor, PID set point, PID measured value, PID deviation, inverter I/O terminal monitor, output power, cumulative power, motor thermal load factor, inverter thermal load factor, and PTC thermistor resistance.
		Fault record	Fault record is displayed when a fault occurs. Past 8 fault definitions (output voltage/current/frequency/cumulative energization time right before the fault occurs) are stored.
	Parameter unit (FR-PU07)	Interactive guidance	Function (help) for operation guide *4

Protective/warning function	Protective function	Overcurrent during acceleration, overcurrent during constant speed, overcurrent during deceleration, overvoltage during acceleration, overvoltage during constant speed, overvoltage during deceleration, inverter protection thermal operation, motor protection thermal operation, heatsink overheat, undervoltage *3, input phase loss *5, output side earth (ground) fault overcurrent at start *5, output phase loss, external thermal relay operation *5, PTC thermistor operation *5, parameter error, PU disconnection, retry count excess *5, CPU fault, brake transistor alarm, inrush resistance overheat, analog input error, overspeed occurrence *3 ,PID signal fault *5, stall prevention operation, output current detection value exceeded *5, loss of synchronism detection *3
	Warning function	Fan alarm *2, overcurrent stall prevention, overvoltage stall prevention, PU stop, parameter write error, regenerative brake prealarm *5, electronic thermal relay function prealarm, maintenance output *5, undervoltage, operation panel lock, password locked, inverter reset
Environment	Surrounding air temperature	-10°C to +50°C (non-freezing) *6
	Ambient humidity	90% RH or less (non-condensing)
	Storage temperature *7	-20°C to +65°C
	Atmosphere	Indoors (without corrosive gas, flammable gas, oil mist, dust and dirt, etc.)
	Altitude/vibration	Maximum 1000m above sea level, 5.9m/s ² or less *8 at 10 to 55Hz (directions of X, Y, Z axes)

- *1 The regenerative braking torque indicates the average short-time torque (which varies by the motor loss) that is generated when a motor decelerates in the shortest time by itself from the rated speed. It is not the continuous regenerative torque. When a motor decelerates from a speed higher than the rated speed, the average deceleration torque decreases. When the regenerative power is large, use an option brake unit.
- *2 As the 0.75K or lower are not provided with the cooling fan, this alarm does not function.
- *3 This function is available only when an IPM motor is connected.
- *4 This operation guide is only available with option parameter unit (FR-PU07).
- *5 This protective function is not available in the initial status.
- *6 When using the inverters at the surrounding air temperature of 40°C or less, the inverters can be installed closely attached (0cm clearance). Side-by-side installation is not available for Filterpacks.
- *7 Temperatures applicable for a short time, e.g. in transit.
- *8 When installing Filterpack of 11K or 15K on the rear side of an inverter, do not install to a moving object or place where vibrates (exceeding 1.96m/s²)

Features

Connection example

Standard specs.

Outline dimensions

Terminal connection diagrams
Terminal specs.

Operation panel
Parameter unit
FR Configurator

Parameter list

Parameter descriptions

Protective functions

Options

Precautions

Motor

IPM motor control

Compatibility

Warranty

Without a Filterpack

●FR-F720PJ-0.4K, 0.75K

●FR-F720PJ-1.5K to 3.7K

●FR-F740PJ-0.4K to 3.7K

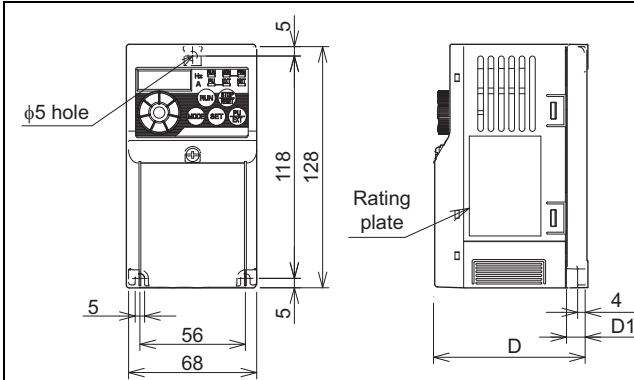

Inverter Model	D	D1
FR-F720PJ-0.4K	112.5	42
FR-F720PJ-0.75K	132.5	62

(Unit: mm)

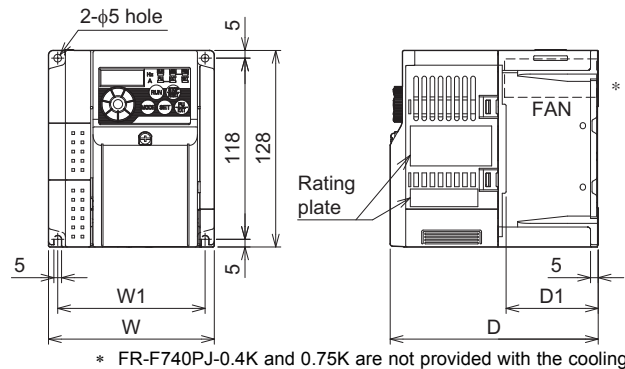

* FR-F740PJ-0.4K and 0.75K are not provided with the cooling fan.

Inverter Model	W	W1	D	D1
FR-F720PJ-1.5K, 2.2K	108	96	135.5	60
FR-F740PJ-1.5K			129.5	54
FR-F740PJ-0.4K, 0.75K			155.5	60
FR-F740PJ-2.2K	170	158	165.5	66.5
FR-F740PJ-3.7K			142.5	
FR-F720PJ-3.7K				

(Unit: mm)

●FR-F720PJ-5.5K, 7.5K

●FR-F740PJ-5.5K, 7.5K

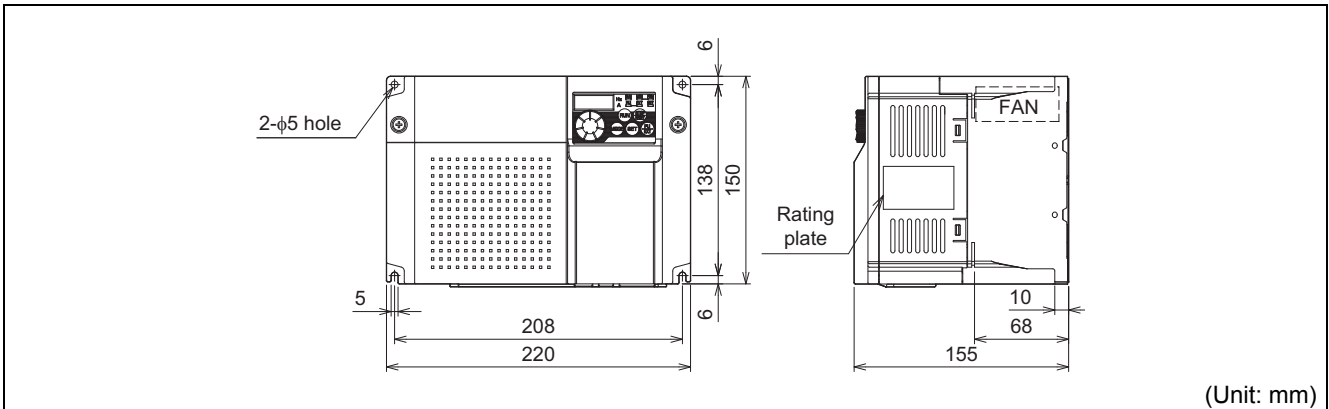

(Unit: mm)

●FR-F720PJ-11K, 15K

●FR-F740PJ-11K, 15K

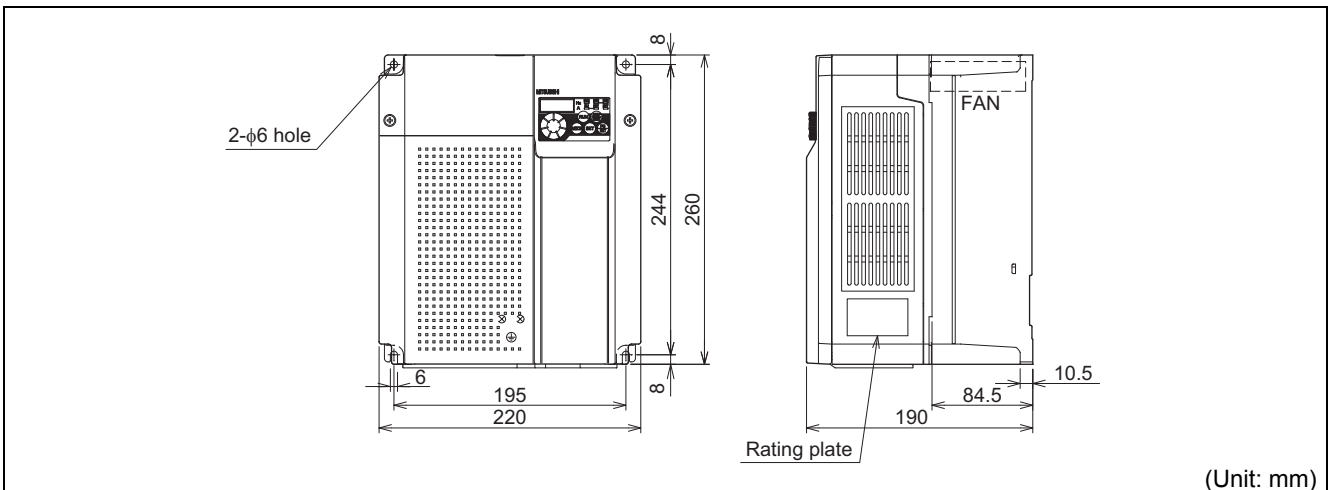

(Unit: mm)

With a Filterpack

A Filterpack can be installed on the side or rear panel of the inverter.

This is a sample outline dimension drawing. The shape differs by the model.

● Filterpack installed on the rear panel

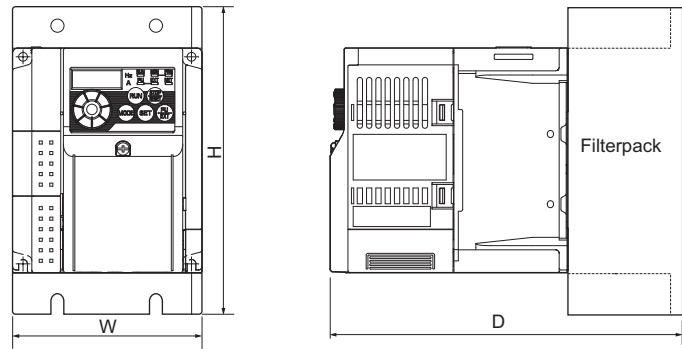

Inverter Model	W	H	D
FR-F720PJ-0.4KF	68	218	172.5
FR-F720PJ-0.75KF	68	218	192.5
FR-F720PJ-1.5KF, 2.2KF	108	188	215.5
FR-F720PJ-3.7KF	170	188	207.5
FR-F720PJ-5.5KF, 7.5KF	220	210	230
FR-F720PJ-11KF, 15KF	220	320	275
FR-F740PJ-0.4KF, 0.75KF	108	188	184.5
FR-F740PJ-1.5KF	108	188	215.5
FR-F740PJ-2.2KF	108	188	235.5
FR-F740PJ-3.7KF	108	188	245.5
FR-F740PJ-5.5KF, 7.5KF	220	210	230
FR-F740PJ-11KF, 15KF	220	320	275

(Unit: mm)

● Filterpack installed on the side panel

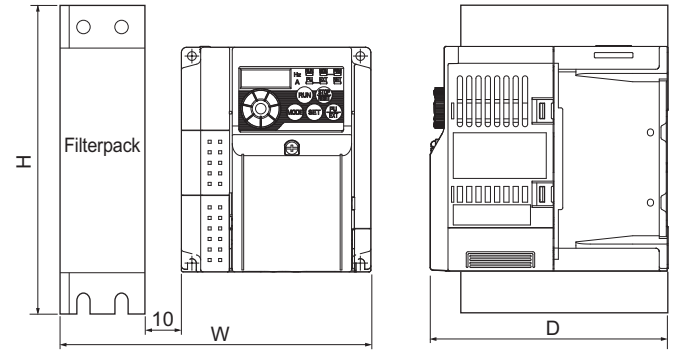

Inverter Model	W*	H	D
FR-F720PJ-0.4KF	138	218	112.5
FR-F720PJ-0.75KF	138	218	132.5
FR-F720PJ-1.5KF, 2.2KF	198	188	135.5
FR-F720PJ-3.7KF	245	188	170
FR-F720PJ-5.5KF, 7.5KF	305	210	195
FR-F720PJ-11KF, 15KF	315	320	195
FR-F740PJ-0.4KF, 0.75KF	173	188	129.5
FR-F740PJ-1.5KF	198	188	135.5
FR-F740PJ-2.2KF	198	188	155.5
FR-F740PJ-3.7KF	198	188	165.5
FR-F740PJ-5.5KF, 7.5KF	305	210	195
FR-F740PJ-11KF, 15KF	315	320	195

(Unit: mm)

* The clearance between the inverter and the filter is 10mm.

Features

Connection example

Standard specs.

Outline dimensions

Terminal connection diagrams
Terminal specs.

Operation panel
Parameter unit
FR Configurator

Parameter list

Parameter descriptions

Protective functions

Options

Precautions

Motor

IPM motor control

Compatibility

Warranty

Filterpack

- FR-BFP2-0.4K, 0.75K, 1.5K, 2.2K, 3.7K
- FR-BFP2-H0.4K, H0.75K, H1.5K, H2.2K, H3.7K

- FR-BFP2-5.5K, 7.5K, 11K, 15K
- FR-BFP2-H5.5K, H7.5K, H11K, H15K

(Unit mm)

Capacity	W	W1	W2	H	H1	D	D1	D2	L	L1	
200V	0.4K, 0.75K	68	30	19	218	208	60	30	15	240	220
	1.5K, 2.2K	108	55	26.5	188	178	80	55	12.5	200	220
	3.7K	170	120	25	188	178	65	40	12.5	220	240
400V	H0.4K, H0.75K *1	108	55	26.5	188	178	55	30	12.5	200	220
	H1.5K to H3.7K	108	55	26.5	188	178	80	55	12.5	200	220

*1 The 400V class H0.4K and H0.75K have no slit.

Capacity	H	H1	H2	D	D1	C	C1	C2	L	L2	
200V	5.5K, 7.5K	210	198	6	75	50	4.5	4.5	5.3	270	400
	11K	320	305	7.5	85	60	6	6	5.3	280	280
	15K	320	305	7.5	85	60	6	6	6.4	260	260
400V	H5.5K, H7.5K	210	198	6	75	50	4.5	4.5	4.3	270	400
	H11K	320	305	7.5	85	60	6	6	4.3	280	280
	H15K	320	305	7.5	85	60	6	6	6.4	260	260

*2 For rear panel installation, an L-bracket is required. The L-bracket is enclosed, but not installed to the inverter at the factory.

Parameter unit (option) (FR-PU07)

(Unit: mm)

*1 When installing the FR-PU07 on the enclosure, etc., remove screws or fix the screws to the FR-PU07 with M3 nuts.

*2 Select the installation screw whose length will not exceed the effective depth of the installation screw hole.

Enclosure surface operation panel (option) (FR-PA07)

(Unit: mm)

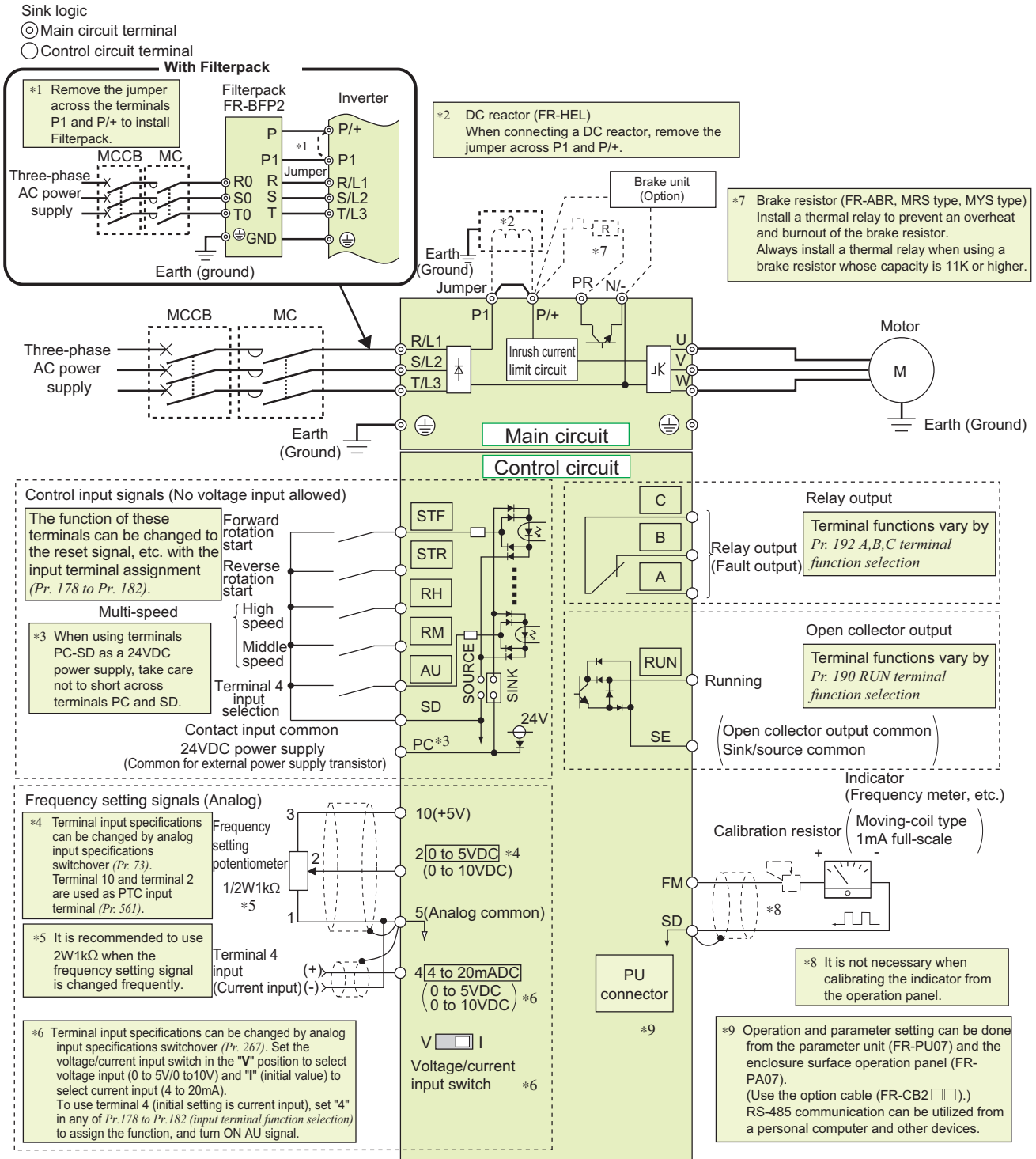

NOTE

- To prevent a malfunction caused by noise, separate the signal cables more than 10cm from the power cables. Also separate the main circuit wire of the input side and the output side.
- After wiring, wire offcuts must not be left in the inverter.
 Wire offcuts can cause an alarm, failure or malfunction. Always keep the inverter clean. When drilling mounting holes in an enclosure etc., take care not to allow chips and other foreign matter to enter the inverter.
- The terminals S1, S2, SC, and SO are for manufacturer setting. Do not remove the shortening wires across the terminals S1 and SC and the terminals S2 and SC.

Features
 Connection example
 Standard specs.
 Outline dimensions
 Terminal connection diagrams
 Terminal specs.
 Operation panel
 Parameter unit
 FR Configurator
 Parameter list
 Parameter descriptions
 Protective functions
 Options
 Precautions
 Motor
 IPM motor control
 Compatibility
 Warranty

Type	Terminal Symbol	Terminal Name	Terminal Specification			
Main circuit	Inverter	R/L1, S/L2, T/L3	AC power input	Connect to the commercial power supply. Do not connect anything to these terminals when using the high power factor converter (FR-HC2) or power regeneration common converter (FR-CV). To use Filterpack, connect the R, S, and T cables of Filterpack.		
		U, V, W	Inverter output	Connect a three-phase squirrel-cage motor or a dedicated IPM motor.		
		P/+, PR	Brake resistor connection	Connect a brake resistor (FR-ABR, MRS type, MYS type) across terminals P/+ and PR.		
		P/+, N/-	Brake unit connection	Connect the brake unit (FR-BU2), power regeneration common converter (FR-CV) or high power factor converter (FR-HC2).		
		P/+, P1	DC reactor (Filterpack) connection	Remove the jumper across terminals P/+ and P1 and connect a DC reactor. To use Filterpack, remove the jumper across the terminals P/+ and P1, then connect the P and P1 cables of Filterpack.		
	Filterpack	⊕	Earth (Ground)	For earthing (grounding) the inverter chassis. Must be earthed (grounded). To use Filterpack, connect the GND cable of Filterpack.		
		R0, S0, T0	Commercial power supply input	Connect to the commercial power supply.		
		⊕	Earth (Ground)	For earthing (grounding) the Filterpack. Must be earthed (grounded).		
		R, S, T	Inverter power supply	Connect to R/L1, S/L2, and T/L3 of the inverter.		
		P, P1	DC reactor terminal	Remove the jumper across terminals P/+ and P1, and connect to the terminals P/+ and P1 of the inverter.		
Control circuit/Input signal	Contact input	STF	Forward rotation start	Turn ON the STF signal to start forward rotation and turn it OFF to stop.	When the STF and STR signals are turned ON simultaneously, the stop command is given.	
		STR	Reverse rotation start	Turn ON the STR signal to start reverse rotation and turn it OFF to stop.		
		RH, RM	Multi-speed selection	Multi-speed can be selected according to the combination of RH and RM signals.		
		AU	Terminal 4 input selection	The terminal 4 function is available only when the AU signal is ON. (the operation with the frequency setting signal of 4 to 20mA DC is available) Turning ON the AU signal disables the terminal 2 (voltage input) function.		
	SD	Contact input common (sink) (initial setting)	Common terminal for contact input terminal (sink logic) and terminal FM.			
		External transistor common (source)	Connect this terminal to the power supply common terminal of a transistor output (open collector output) device, such as a programmable controller, in the source logic to avoid malfunction by undesirable current.			
		24VDC power supply common	Common output terminal for 24VDC 0.1A power supply (PC terminal). Isolated from terminals 5 and SE.			
	PC	External transistor common (sink) (initial setting)	Connect this terminal to the power supply common terminal of a transistor output (open collector output) device, such as a programmable controller, in the sink logic to avoid malfunction by undesirable current.			
		Contact input common (source)	Common terminal for contact input terminal (source logic).			
		24VDC power supply	Can be used as 24VDC 0.1A power supply.			
Frequency setting	10	Frequency setting power supply	Used as power supply when connecting potentiometer for frequency setting (speed setting) from outside of the inverter.	5VDC permissible load current 10mA		
	2	Frequency setting (voltage)	Inputting 0 to 5VDC (or 0 to 10V) provides the maximum output frequency at 5V (10V) and makes input and output proportional. Use Pr. 73 to switch between input 0 to 5VDC input (initial setting) and 0 to 10VDC.	Input resistance 10kΩ ± 1kΩ Permissible maximum voltage 20VDC		
	4	Frequency setting (current)	Inputting 4 to 20mADC (or 0 to 5V, 0 to 10V) provides the maximum output frequency at 20mA and makes input and output proportional. The input signal to terminal 4 is valid only when the AU signal is ON (terminal 2 input is invalid). Use Pr. 267 to switch from among input 4 to 20mA (initial setting), 0 to 5VDC and 0 to 10VDC. Set the voltage/current input switch in the "V" position to select voltage input (0 to 5V/0 to 10V).	Current input: Input resistance 249Ω ± 5Ω Maximum permissible current 30mA Voltage input: Input resistance 10kΩ ± 1kΩ Permissible maximum voltage 20VDC		
	5	Frequency setting common	Frequency setting signal (terminal 2 or 4) common terminal. Do not earth (ground).			
Thermistor	10	PTC thermistor input	For connecting PTC thermistor output.	Adaptive PTC thermistor specification Heat detection resistance : 500Ω to 30kΩ (Set by Pr. 561)		
	2		When PTC thermistor protection is valid (Pr. 561 ≠ "9999"), terminal 2 is not available for frequency setting.			

Type	Terminal Symbol	Terminal Name	Terminal Specification	
Control circuit terminal/Output signal	Relay	A, B, C	Relay output (fault output)	1 changeover contact output indicates that the inverter protective function has activated and the output stopped. Fault: discontinuity across B-C (continuity across A-C), Normal: continuity across B-C (discontinuity across A-C) Contact capacity:230VAC 0.3A (power factor =0.4) 30VDC 0.3A
	Open collector	RUN	Inverter running	Switched Low when the inverter output frequency is equal to or higher than the starting frequency (initial value 0.5Hz). Switched High during stop or DC injection brake operation. (Low is when the open collector output transistor is ON (conducts). High is when the transistor is OFF (does not conduct).) Permissible load 24VDC (maximum 27VDC) 0.1A (a voltage drop is 3.4V maximum when the signal is ON)
		SE	Open collector output common	Common terminal of terminal RUN.
	Pulse	FM	For meter	Selected one e.g. output frequency from monitored items. (Not output during inverter reset.) The output signal is proportional to the magnitude of the corresponding monitored item. Permissible load current 1mA 1440 pulses/s at full scale
Communication	—	PU connector	With the PU connector, communication can be established through RS-485. •Conforming standard: EIA-485 (RS-485) •Transmission format: Multidrop link •Communication speed: 4800 to 38400bps •Overall length: 500m	



NOTE

- To change the input specification for terminal 4, set *Pr. 267* and the voltage/current input switch correctly, then input the analog signal relevant to the setting. Applying a voltage with voltage/current input switch in "I" position (current input is selected) or a current with switch in "V" position (voltage input is selected) could cause component damage of the inverter or analog circuit of output devices.
- Connecting the power supply to the inverter output terminals (U, V, W) will damage the inverter. Do not perform such wiring.
- indicates that terminal functions can be selected using *Pr. 178 to Pr. 182, Pr. 190 and Pr. 192 (I/O terminal function selection)*.
- The terminal names and functions shown here are the initial settings.
- The terminals S1, S2, SC, and SO are for manufacturer setting. Do not connect anything to these. Doing so may cause an inverter failure. Do not remove the shortening wires across the terminals S1 and SC and the terminals S2 and SC. Removing either shortening wire disables the inverter operation.

- Features
- Connection example
- Standard specs.
- Outline dimensions
- Terminal connection diagrams
Terminal specs.
- Operation panel
Parameter unit
FR Configurator
- Parameter list
- Parameter descriptions
- Protective functions
- Options
- Precautions
- Motor
- IPM motor control
- Compatibility
- Warranty

The operation panel cannot be removed from the inverter.

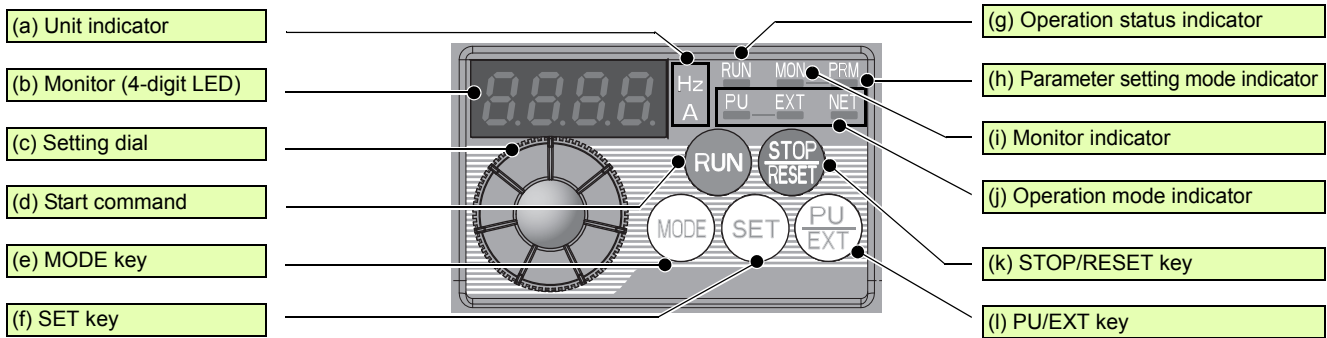

No.	Component	Name	Description
(a)		Unit indicator	Hz: Lit to indicate frequency. (Flickers when the set frequency monitor is displayed.) A: Lit to indicate current. (Both "Hz" and "A" turns OFF to indicate a value other than frequency or current.)
(b)		Monitor (4-digit LED)	Shows the frequency, parameter number, etc. (To monitor the output power, the set frequency and other items, set Pr. 52.)
(c)		Setting dial	The dial of the Mitsubishi inverters. The setting dial is used to change the frequency and parameter settings. Press the setting dial to perform the following operations: <ul style="list-style-type: none"> To display a control method (general-purpose motor control or IPM motor control) during the monitor mode To display the set frequency when pressed for 1s or longer under PU operation mode or External/PU combined operation mode (Pr. 79 = "3") To display the present setting during calibration To display a fault history number in the faults history mode
(d)		Start command	Select the rotation direction in Pr. 40.
(e)		MODE key	Used to switch among different setting modes. Pressing simultaneously changes the operation mode. Holding this key for 2 seconds locks the operation. The key lock is invalid when Pr. 161 = "0 (initial setting)."
(f)		SET key	Used to enter a setting. If pressed during the operation, monitored item changes as the following: <div style="border: 1px solid black; padding: 5px; display: inline-block; margin-top: 10px;"> Output frequency → Output current → Output voltage* </div> * Energy saving monitor is displayed when the energy saving monitor is set with Pr. 52.
(g)		Operation status indicator	Lit or flickers during inverter operation.* * Lit: When the forward rotation operation is being performed. Slow flickering (1.4s cycle): When the reverse rotation operation is being performed. Fast flickering (0.2s cycle): When has been pressed or the start command has been given, but the operation cannot be made. <ul style="list-style-type: none"> When the frequency command is less than the starting frequency. When the MRS signal is being input.
(h)		Parameter setting mode indicator	Lit to indicate the parameter setting mode.
(i)		Monitor indicator	Lit to indicate the monitor mode.
(j)		Operation mode indicator	PU: Lit to indicate the PU operation mode. EXT: Lit to indicate the External operation mode.(EXT is lit at power-ON in the initial setting.) NET: Lit to indicate the Network operation mode. PU and EXT: Lit to indicate EXT/PU combined operation mode 1 and 2 All of these indicators are OFF when the command source is not at the operation panel.
(k)		STOP/RESET key	Used to stop operation commands. Used to reset a fault when the protective function (fault) is activated.
(l)		PU/EXT key	Used to switch between the PU and External operation modes. To use the External operation mode (operation using a separately connected frequency setting potentiometer and start signal), press this key to light up the EXT indicator. (Press simultaneously (0.5s), or change the Pr. 79 setting to change to the combined operation mode.) PU: PU operation mode EXT: External operation mode Used to cancel the PU stop also.

Basic Operation of the Operation Panel

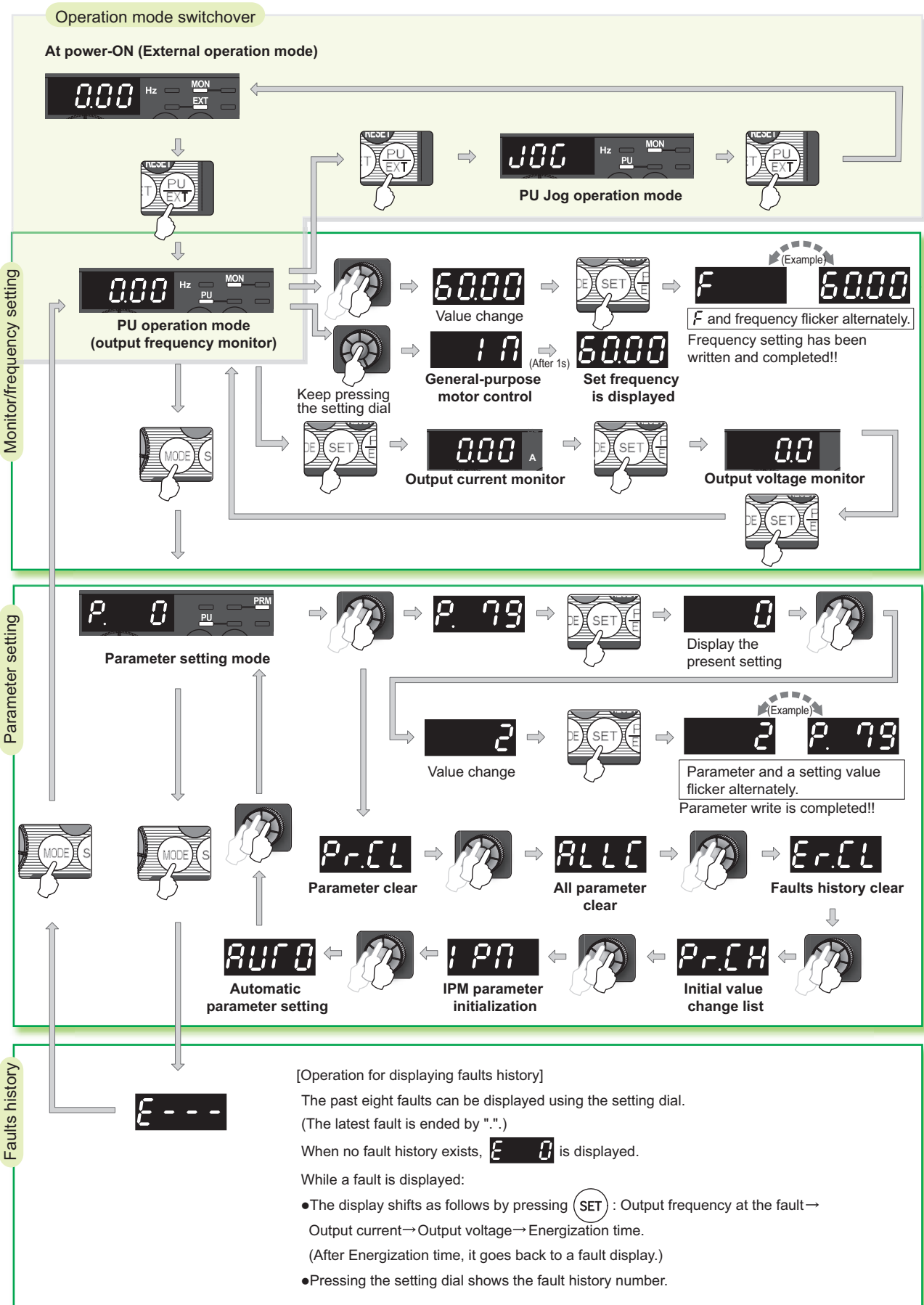

- Features
- Connection example
- Standard specs.
- Outline dimensions
- Terminal connection diagrams
Terminal specs.
- Operation panel
Parameter unit
FR Configurator
- Parameter list
- Parameter descriptions
- Protective functions
- Options
- Precautions
- Motor
- IPM motor control
- Compatibility
- Warranty

Parameter unit (FR-PU07)

- The parameter unit is a convenient tool for inverter setting such as direct input method with a numeric keypad, operation status indication, and help function.
- Eight languages can be displayed.
- Parameter setting values of maximum of three inverters can be stored.
- * The parameter unit connection cable FR-CB20□ is required for connecting to the inverter.

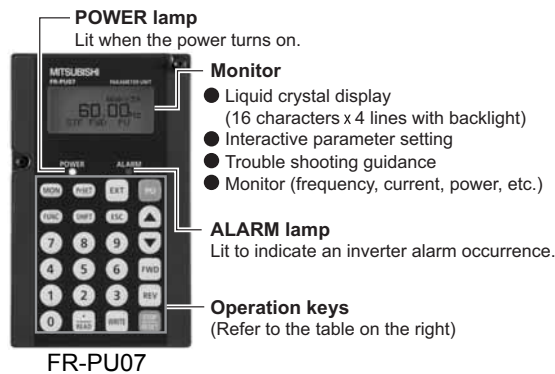

Key	Description
PrSET	Use for parameter setting Press to choose the parameter setting mode.
MON	First priority monitor is displayed. In the initial setting, the output frequency is displayed.
ESC	Operation cancel key
FUNC	Used to display the function menu. A variety of functions can be used on the function menu.
SHIFT	Used to shift to the next item in the setting or monitoring mode.
0 to 9	Used to enter a frequency, parameter number or set value.
EXT	Inverter operates in the External operation mode.
PU	Used to select the PU operation mode to display the frequency setting screen.
▲ ▼	<ul style="list-style-type: none"> • Used to keep on increasing or decreasing the running frequency. Hold down to vary the frequency. • Press either of these keys on the parameter setting mode screen to change the parameter setting value sequentially. • On the selecting screen, these keys are used to move the cursor.
FWD	Forward rotation command key.
REV	Reverse rotation command key.
STOP / RESET	<ul style="list-style-type: none"> • Stop command key. • Used to reset the inverter when an alarm occurs.
WRITE	<ul style="list-style-type: none"> • Used to write a set value in the setting mode. • Used as a clear key in the all parameter clear or alarm history clear mode.
• / READ	<ul style="list-style-type: none"> • Used as a decimal point when entering numerical value. • Press to read the item selected with the cursor.

●Main functions

Function	Description
Monitor	6 types of monitors appear by simply pressing SHIFT .
Frequency setting	For PU operation mode and External/PU combined operation mode (<i>Pr.79 = "3"</i>), frequency setting is available. Settings is performed by the direct setting, which sets frequency directly by 0 to 9 , and the step setting, which sets frequency continuously by ▲ ▼ .
Parameter Setting	Reading parameter and changing setting values are easily done. To change the setting value of an parameter, specify the parameter number, or select a parameter from the functional parameter list.
Batch copy	FR-PU07 (PU07BB) reads parameter settings of an inverter, and stores three different parameter settings. FR-PU07 (PU07BB) can also copy the stored parameter setting to another inverter of the same series, or verify its stored parameter setting against the parameter setting stored in an inverter.
Operation	Switching between External operation mode [EXT] and PU operation mode [PU] is easy. Start/stop is enabled during PU operation mode and External/PU operation mode (<i>Pr.79 = "3"</i>).

* Available function differs by the inverter. Please refer to the instruction manual of the inverter and the parameter unit

FR-SW3-SETUP-WE

(Windows® 2000 Professional SP4 or later, Windows® XP Home Edition SP2 or later, Windows® XP Professional SP2 or later, Windows Vista® SP1 or later, Windows® 7 supported)

FR Configurator is software that offers an easy operating environment. Can be utilized effectively from inverter setting up to maintenance.

Parameter setting, monitoring, etc. can be performed on a display of Windows*1 personal computer.

RS-485 communication*2 is available to connect a personal computer to an inverter using a PU connector.

*1 Windows and Windows Vista are registered trademarks of Microsoft Corporation in the United States and other countries

*2 An RS-485-to-RS-232C or USB-to-RS-485 converter is required separately.

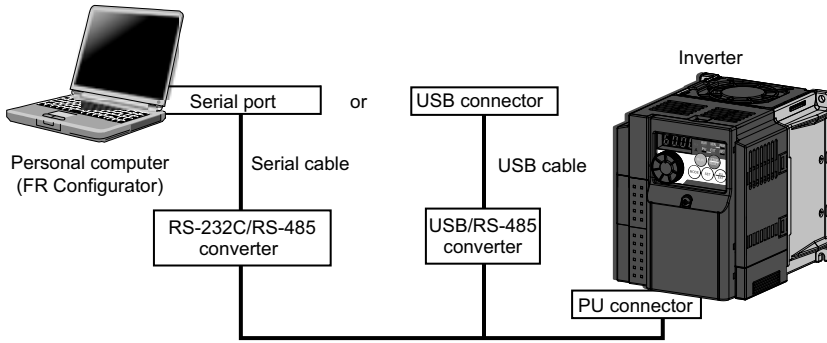

FR Configurator



● Startup

Desired function can be performed just after a start-up of the software.

- (1) Open the recent used System File
- (2) Perform Easy Setup
- (3) Perform each function
- (4) Help



● Easy Setup

From station number to parameter setting, setting with wizard style dialog (interactive) is available.

Procedure for Easy Setup

- (1) System File setting
- (2) Communication setting
- (3) Inverter recognition
- (4) Control method selection
- (5) Motor setting
- (6) Start command, frequency command setting
- (7) Parameter setting



● Navigation area

In Navigation area, switching ONLINE/ OFFLINE and changing operation mode can be performed.

- (1) Frequency setting and forward/reverse rotation [Test operation]
- (2) Display the connected inverter in tree view [System List]
- (3) Function setting without regard to parameter number [Basic setting]
- (4) Estimates the cause of trouble, and suggests counteraction. [Troubleshooting]

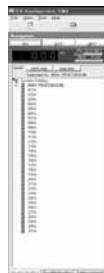

● Monitor area

In Monitor area, inverter status can be monitored.

- (1) Displays monitor data in waveform [Graph]
- (2) Monitors the status of I/O terminals. [I/O Terminal Monitor]
- (3) Displays multiple data in batch [Batch Monitor]



● System area

In System area, parameter setting, Diagnosis, Troubleshooting, etc. can be performed.

- (1) Parameter reading, writing, verification, Functional List and Individual List display are available. [Parameter List]
- (2) Displays alarm history and monitor value at each alarm occurrence. [Diagnosis]
- (3) Parameter setting conversion from conventional models [Convert]



● Setting wizard

Setting wizard can set parameters with wizard style dialog (interactive). Inputting or selecting required items for each function, parameter setting can be made, without regard to parameter number.

● Help

Displays operating instructions and details of each parameters.

FR-SW3-SETUP-WE is available for download (free of charge) from the below URL on the internet. FR Configurator SW3 (FR-SW3-SETUP-WE or FR-SW1-SETUP-WE) needs to be installed to the personal computer prior to updating the software. Also, user registration is required for the download (free of charge.) (Registration is free of charge.)

Homepage address <http://www.MitsubishiElectric.co.jp/fa/>

The SW2 user should click "FA HOME>Products>Drive Products>Inverters-FREQROL>Design Support Tool/Data" and "FR-SW3-SETUP-WJ".

FR-SW3-SETUP-WE (for 700 series) and FR-SW1-SETUP-WE (500 series) can be installed from the FR Configurator SW3.

Features

Connection example

Standard specs.

Outline dimensions

Terminal connection diagrams
Terminal specs.

Operation panel
Parameter unit
FR Configurator

Parameter list

Parameter descriptions

Protective functions

Options

Precautions

Motor

IPM motor control

Compatibility

Warranty

For simple variable-speed operation of the inverter, the initial setting of the parameters may be used as they are. Set the necessary parameters to meet the load and operational specifications. Parameter setting, change and check can be made from the operation panel. For details of parameters, refer to the instruction manual.



POINT

- Only simple mode parameters are displayed by the initial setting of Pr.160 Extended function display selection. Set Pr.160 Extended function display selection as required.
- To use the inverter under IPM motor control, refer to page 78.

Pr.160	Remarks
9999 (initial value)	Only the simple mode parameters can be displayed.
0	Simple mode and extended mode parameters can be displayed.

Simple mode parameter

Parameter Number	Name	Unit	Initial Value	Range	Application	Refer to page
0	Torque boost	0.1%	6%/4%/3%/2% *	0 to 30%	Use this parameter to increase starting torque under V/F control. Use this when a loaded motor cannot be driven and the warning [OL] occurs, then the inverter trips with [OC1] under V/F control. * Initial value depends on the inverter capacity. (0.75K or less/1.5K to 3.7K/5.5K, 7.5K/11K, 15K)	30
1	Maximum frequency	0.01Hz	120Hz	0 to 120Hz	Use this parameter to set the upper limit for the output frequency.	30
2	Minimum frequency	0.01Hz	0Hz	0 to 120Hz	Use this parameter to set the lower limit for the output frequency.	
3	Base frequency	0.01Hz	60Hz	0 to 400Hz	Use this parameter when the rated motor frequency is 50Hz. Check the rating plate of the motor.	30
4	Multi-speed setting (high speed)	0.01Hz	60Hz	0 to 400Hz	Use these parameters to change among pre-set operation speeds with the terminals. The speeds are pre-set with parameters.	30
5	Multi-speed setting (middle speed)	0.01Hz	30Hz	0 to 400Hz		
6	Multi-speed setting (low speed)	0.01Hz	10Hz	0 to 400Hz		
7	Acceleration time	0.1s	5s/15s *	0 to 3600s	Use these parameters to set the acceleration/deceleration time.	31
8	Deceleration time	0.1s	10s/30s *	0 to 3600s	* Initial value depends on the inverter capacity. (7.5K or less/11K, 15K)	
9	Electronic thermal O/L relay	0.01A	Rated inverter current	0 to 500A	With this parameter, the inverter protects the motor from heat. Set the rated motor current.	31
79	Operation mode selection	1	0	0, 1, 2, 3, 4, 6, 7	Use this parameter to select the source of start command and frequency setting.	40
125	Terminal 2 frequency setting gain frequency	0.01Hz	60Hz	0 to 400Hz	Use this parameter to change the frequency at the maximum potentiometer setting (5V in the initial setting)	43
126	Terminal 4 frequency setting gain frequency	0.01Hz	60Hz	0 to 400Hz	Use this parameter to change the frequency at the maximum current input (20mA in the initial setting)	43
160	Extended function display selection	1	9999	0, 9999	Parameter which can be read from the operation panel and parameter unit can be restricted.	44
998	IPM parameter initialization	1	0	0, 1, 12, 101, 112	By performing IPM parameter initialization, IPM motor control is selected and the parameters, which are required to drive an IPM motor, are changed.	77
999	Automatic parameter setting	1	9999	10, 20, 21, 9999	Parameter settings are changed as a batch. Those include communication parameter settings for the Mitsubishi's human machine interface (GOT) connection and the parameter setting for the rated frequency settings of 50Hz/60Hz.	53

Parameter Number	Name	Unit	Initial Value	Range	Application	Refer to page
Pr.CL	Parameter clear	1	0	0, 1	Setting "1" returns all parameters except calibration parameters to the initial values.	53
ALLC	All parameter clear	1	0	0, 1	Setting "1" returns all parameters to the initial values.	53
Er.CL	Faults history clear	1	0	0, 1	Setting "1" clears eight past faults.	53
Pr.CH	Initial value change list	—	—	—	Displays and sets the parameters changed from the initial value.	53
IPM	IPM parameter initialization	1	0	0, 1, 12	Use this parameter to select the IPM motor control and to change parameter settings to the settings required to drive an IPM motor.	77
AUTO	Automatic parameter setting	—	—	—	Parameter settings are changed as a batch. Those include communication parameter settings for the Mitsubishi's human machine interface (GOT) connection and the parameter setting for the rated frequency settings of 50Hz.	53

Features

Connection example

Standard specs.

Outline dimensions

Terminal connection diagrams
Terminal specs.

Operation panel
Parameter unit
FR Configurator

Parameter list

Parameter descriptions

Protective functions

Options

Precautions

Motor

IPM motor control

Compatibility

Warranty

Extended mode parameter



REMARKS

- The parameters marked with © indicate simple mode parameters.
- The shaded parameters in the table allow its setting to be changed during operation even if "0" (initial value) is set in Pr.77 Parameter write selection.

Function	Parameter	Name	Setting Range	Minimum Setting Increments	Initial Value	Refer to Page	Customer Setting
Basic functions	© 0	Torque boost	0 to 30%	0.1%	6/4/3/2% *1	30	
	© 1	Maximum frequency	0 to 120Hz	0.01Hz	120Hz	30	
	© 2	Minimum frequency	0 to 120Hz	0.01Hz	0Hz	30	
	© 3	Base frequency	0 to 400Hz	0.01Hz	60Hz	30	
	© 4	Multi-speed setting (high speed)	0 to 400Hz	0.01Hz	60Hz	30	
	© 5	Multi-speed setting (middle speed)	0 to 400Hz	0.01Hz	30Hz	30	
	© 6	Multi-speed setting (low speed)	0 to 400Hz	0.01Hz	10Hz	30	
	© 7	Acceleration time	0 to 3600s	0.1s	5/15s *2	31	
	© 8	Deceleration time	0 to 3600s	0.1s	10/30s *3	31	
DC injection brake	© 9	Electronic thermal O/L relay	0 to 500A	0.01A	Rated inverter current	31	
	10	DC injection brake operation frequency	0 to 120Hz	0.01Hz	3Hz	31	
	11	DC injection brake operation time	0 to 10s	0.1s	0.5s	31	
—	12	DC injection brake operation voltage	0 to 30%	0.1%	4/2% *4	31	
	13	Starting frequency	0 to 60Hz	0.01Hz	0.5Hz	31	
—	14	Load pattern selection	0, 1	1	1	32	
	15	Jog frequency	0 to 400Hz	0.01Hz	5Hz	32	
—	16	Jog acceleration/deceleration time	0 to 3600s	0.1s	0.5s	32	
	17	MRS input selection	0, 2, 4	1	0	32	
—	18	High speed maximum frequency	120 to 400Hz	0.01Hz	120Hz	30	
	19	Base frequency voltage	0 to 1000V, 8888, 9999	0.1V	9999	30	
Acceleration/ deceleration time	20	Acceleration/deceleration reference frequency	1 to 400Hz	0.01Hz	60Hz	31	
	Stall prevention	22	Stall prevention operation level	0 to 150%	0.1%	120%	33
23		Stall prevention operation level compensation factor at double speed	0 to 200%, 9999	0.1%	9999	33	
Multi-speed setting	24	Multi-speed setting (speed 4)	0 to 400Hz, 9999	0.01Hz	9999	30	
	25	Multi-speed setting (speed 5)	0 to 400Hz, 9999	0.01Hz	9999	30	
	26	Multi-speed setting (speed 6)	0 to 400Hz, 9999	0.01Hz	9999	30	
—	27	Multi-speed setting (speed 7)	0 to 400Hz, 9999	0.01Hz	9999	30	
	29	Acceleration/deceleration pattern selection	0 to 2	1	0	33	
—	30	Regenerative function selection	0 to 2	1	0	33,36	
	Frequency jump	31	Frequency jump 1A	0 to 400Hz, 9999	0.01Hz	9999	34
32		Frequency jump 1B	0 to 400Hz, 9999	0.01Hz	9999	34	
33		Frequency jump 2A	0 to 400Hz, 9999	0.01Hz	9999	34	
34		Frequency jump 2B	0 to 400Hz, 9999	0.01Hz	9999	34	
35		Frequency jump 3A	0 to 400Hz, 9999	0.01Hz	9999	34	
—	36	Frequency jump 3B	0 to 400Hz, 9999	0.01Hz	9999	34	
	37	Speed display	0, 0.01 to 9998	0.001	0	34	
—	40	RUN key rotation direction selection	0, 1	1	0	34	

Function	Parameter	Name	Setting Range	Minimum Setting Increments	Initial Value	Refer to Page	Customer Setting
Frequency detection	41	Up-to-frequency sensitivity	0 to 100%	0.1%	10%	34	
	42	Output frequency detection	0 to 400Hz	0.01Hz	6Hz	34	
	43	Output frequency detection for reverse rotation	0 to 400Hz, 9999	0.01Hz	9999	34	
Second functions	44	Second acceleration/deceleration time	0 to 3600s	0.1s	5/15s*2	31	
	45	Second deceleration time	0 to 3600s, 9999	0.1s	9999	31	
	46	Second torque boost	0 to 30%, 9999	0.1%	9999	30	
	47	Second V/F (base frequency)	0 to 400Hz, 9999	0.01Hz	9999	30	
	48	Second stall prevention operation current	0 to 150%, 9999	0.1%	9999	33	
	51	Second electronic thermal O/L relay	0 to 500A, 9999	0.01A	9999	31	
Monitor functions	52	DU/PU main display data selection	0, 5, 8 to 12, 14, 20, 23 to 25, 50 to 55, 61, 62, 64, 100	1	0	35	
	54	FM terminal function selection	1 to 3, 5, 8 to 12, 14, 21, 24, 50, 52, 53, 61, 62	1	1	35	
	55	Frequency monitoring reference	0 to 400Hz	0.01Hz	60Hz	35	
	56	Current monitoring reference	0 to 500A	0.01A	Rated inverter current	35	
Automatic restart functions	57	Restart coasting time	0, 0.1 to 5s, 9999	0.1s	9999	36	
	58	Restart cushion time	0 to 60s	0.1s	1s	36	
—	59	Remote function selection	0 to 3	1	0	37	
—	60	Energy saving control selection	0, 9	1	0	37	
—	65	Retry selection	0 to 5	1	0	38	
—	66	Stall prevention operation reduction starting frequency	0 to 400Hz	0.01Hz	60Hz	33	
Retry	67	Number of retries at fault occurrence	0 to 10, 101 to 110	1	0	38	
	68	Retry waiting time	0.1 to 600s	0.1s	1s	38	
	69	Retry count display erase	0	1	0	38	
—	70	Special regenerative brake duty	0 to 30%	0.1%	0%	33	
—	71	Applied motor	0, 1, 3, 13, 23, 40, 43, 50, 53, 120, 210	1	0	38,41	
—	72	PWM frequency selection	0 to 15	1	1	39	
—	73	Analog input selection	0, 1, 10, 11	1	1	39	
—	74	Input filter time constant	0 to 8	1	1	39	
—	75	Reset selection/disconnected PU detection/PU stop selection	0 to 3, 14 to 17	1	14	40	
—	77	Parameter write selection	0 to 2	1	0	40	
—	78	Reverse rotation prevention selection	0 to 2	1	0	40	
—	Ⓢ 79	Operation mode selection	0 to 4, 6, 7	1	0	40	
Motor constants	80	Motor capacity	0.4 to 15kW, 9999	0.01kW	9999	41	
	82	Motor excitation current	0 to 500A, 9999	0.01A	9999	42	
	83	Rated motor voltage	0 to 1000V	0.1V	200V/400V *?????????	42	
	84	Rated motor frequency	10 to 120Hz	0.01Hz	60Hz	42	
	90	Motor constant (R1)	0 to 50Ω, 9999	0.001Ω	9999	42	
	96	Auto tuning setting/status	0, 11, 21	1	0	42	
PU connector communication	117	PU communication station number	0 to 31 (0 to 247)	1	0	42	
	118	PU communication speed	48, 96, 192, 384	1	192	42	
	119	PU communication stop bit length	0, 1, 10, 11	1	1	42	
	120	PU communication parity check	0 to 2	1	2	42	
	121	Number of PU communication retries	0 to 10, 9999	1	1	42	
	122	PU communication check time interval	0, 0.1 to 999.8s, 9999	0.1s	0	42	
	123	PU communication waiting time setting	0 to 150ms, 9999	1	9999	42	
	124	PU communication CR/LF selection	0 to 2	1	1	42	
—	Ⓢ 125	Terminal 2 frequency setting gain frequency	0 to 400Hz	0.01Hz	60Hz	43	
—	Ⓢ 126	Terminal 4 frequency setting gain frequency	0 to 400Hz	0.01Hz	60Hz	43	

Features

Connection example

Standard specs.

Outline dimensions

Terminal connection diagrams
Terminal specs.Operation panel
Parameter unit
FR Configurator

Parameter list

Parameter descriptions

Protective functions

Options

Precautions

Motor

IPM motor control

Compatibility

Warranty

Function	Parameter	Name	Setting Range	Minimum Setting Increments	Initial Value	Refer to Page	Customer Setting	
PID operation	127	PID control automatic switchover frequency	0 to 400Hz, 9999	0.01Hz	9999	44		
	128	PID action selection	0, 20, 21	1	0	44		
	129	PID proportional band	0.1 to 1000%, 9999	0.1%	100%	44		
	130	PID integral time	0.1 to 3600s, 9999	0.1s	1s	44		
	131	PID upper limit	0 to 100%, 9999	0.1%	9999	44		
	132	PID lower limit	0 to 100%, 9999	0.1%	9999	44		
	133	PID action set point	0 to 100%, 9999	0.01%	9999	44		
134	PID differential time	0.01 to 10s, 9999	0.01s	9999	44			
—	144	Speed setting switchover	2, 4, 6, 8, 10, 102, 104, 106, 108, 110	1	4	34		
PU	145	PU display language selection	0 to 7	1	0	44		
—	146 *6	Built-in potentiometer switching	0, 1	1	1	44		
Current detection	150	Output current detection level	0 to 150%	0.1%	120%	44		
	151	Output current detection signal delay time	0 to 10s	0.1s	0s	44		
	152	Zero current detection level	0 to 150%	0.1%	5%	44		
	153	Zero current detection time	0 to 1s	0.01s	0.5s	44		
—	154	Voltage reduction selection during stall prevention operation	1, 11	1	1	33		
—	156	Stall prevention operation selection	0 to 31, 100, 101	1	0	33		
—	157	OL signal output timer	0 to 25s, 9999	0.1s	0s	33		
—	Ⓢ 160	Extended function display selection	0, 9999	1	9999	44		
—	161	Frequency setting/key lock operation selection	0, 1, 10, 11	1	0	45		
Automatic restart functions	162	Automatic restart after instantaneous power failure selection	0, 1, 10, 11	1	1	36		
	165	Stall prevention operation level for restart	0 to 150%	0.1%	120%	36		
Current detection	166	Output current detection signal retention time	0 to 10s, 9999	0.1s	0.1s	44		
	167	Output current detection operation selection	0, 1	1	0	44		
—	168	Parameter for manufacturer setting. Do not set.						
—	169							
Cumulative monitor clear	170	Watt-hour meter clear	0, 10, 9999	1	9999	35		
	171	Operation hour meter clear	0, 9999	1	9999	35		
Input terminal function selection	178	STF terminal function selection	0 to 5, 7, 8, 10, 12, 14, 16, 24, 25, 60, 62, 64 to 67, 72, 9999	1	60	45		
	179	STR terminal function selection	0 to 5, 7, 8, 10, 12, 14, 16, 24, 25, 61, 62, 64 to 67, 72, 9999	1	61	45		
	180	AU terminal function selection	0 to 5, 7, 8, 10, 12, 14,	1	4	45		
	181	RM terminal function selection	16, 24, 25, 62, 64 to 67,	1	1	45		
	182	RH terminal function selection	72, 9999	1	2	45		

Function	Parameter	Name	Setting Range	Minimum Setting Increments	Initial Value	Refer to Page	Customer Setting
Output terminal function selection	190	RUN terminal function selection	0, 1, 3, 4, 7, 8, 11 to 16, 25, 26, 46 to 48, 57, 64, 70, 79, 90 to 93, 95, 96, 98 to 101, 103, 104, 107, 108, 111 to 116, 125, 126, 146 to 148, 157, 164, 170, 179, 190 to 193, 195, 196, 198, 199, 9999	1	0	46	
	192	A,B,C terminal function selection	0, 1, 3, 4, 7, 8, 11 to 16, 25, 26, 46 to 48, 57, 64, 70, 79, 90, 91, 95, 96, 98 to 101, 103, 104, 107, 108, 111 to 116, 125, 126, 146 to 148, 157, 164, 170, 179, 190, 191, 195, 196, 198, 199, 9999	1	99	46	
Multi-speed setting	232	Multi-speed setting (speed 8)	0 to 400Hz, 9999	0.01Hz	9999	30	
	233	Multi-speed setting (speed 9)	0 to 400Hz, 9999	0.01Hz	9999	30	
	234	Multi-speed setting (speed 10)	0 to 400Hz, 9999	0.01Hz	9999	30	
	235	Multi-speed setting (speed 11)	0 to 400Hz, 9999	0.01Hz	9999	30	
	236	Multi-speed setting (speed 12)	0 to 400Hz, 9999	0.01Hz	9999	30	
	237	Multi-speed setting (speed 13)	0 to 400Hz, 9999	0.01Hz	9999	30	
	238	Multi-speed setting (speed 14)	0 to 400Hz, 9999	0.01Hz	9999	30	
—	239	Multi-speed setting (speed 15)	0 to 400Hz, 9999	0.01Hz	9999	30	
—	240	Soft-PWM operation selection	0, 1	1	1	39	
—	241	Analog input display unit switchover	0, 1	1	0	43	
—	244	Cooling fan operation selection	0, 1	1	1	46	
Slip compensation	245	Rated slip	0 to 50%, 9999	0.01%	9999	46	
	246	Slip compensation time constant	0.01 to 10s	0.01s	0.5s	46	
	247	Constant-power range slip compensation selection	0, 9999	1	9999	46	
—	249	Earth (ground) fault detection at start	0, 1	1	0	46	
—	250	Stop selection	0 to 100s, 1000 to 1100s, 8888, 9999	0.1s	9999	47	
—	251	Output phase loss protection selection	0, 1	1	1	47	
Life diagnosis	255	Life alarm status display	(0 to 15)	1	0	47	
	256	Inrush current limit circuit life display	(0 to 100%)	1%	100%	47	
	257	Control circuit capacitor life display	(0 to 100%)	1%	100%	47	
	258	Main circuit capacitor life display	(0 to 100%)	1%	100%	47	
	259	Main circuit capacitor life measuring	0, 1 (2, 3, 8, 9)	1	0	47	
—	260	PWM frequency automatic switchover	0, 1	1	1	39	
Power failure stop	261	Power failure stop selection	0 to 2	1	0	48	
	267	Terminal 4 input selection	0 to 2	1	0	39	
—	268	Monitor decimal digits selection	0, 1, 9999	1	9999	35	
—	269	Parameter for manufacturer setting. Do not set.					
—	295	Magnitude of frequency change setting	0, 0.01, 0.10, 1.00, 10.00	0.01	0	45	
Password function	296	Password lock level	1 to 6, 101 to 106, 9999	1	9999	48	
	297	Password lock/unlock	1000 to 9998 (0 to 5, 9999)	1	9999	48	
—	298	Frequency search gain	0 to 32767, 9999	1	9999	42	
—	299	Rotation direction detection selection at restarting	0, 1, 9999	1	0	36	

- Features
- Connection example
- Standard specs.
- Outline dimensions
- Terminal connection diagrams
- Terminal specs.
- Operation panel Parameter unit FR Configurator
- Parameter list
- Parameter descriptions
- Protective functions
- Options
- Precautions
- Motor
- IPM motor control
- Compatibility
- Warranty

Function	Parameter	Name	Setting Range	Minimum Setting Increments	Initial Value	Refer to Page	Customer Setting
RS-485 communication	338	Communication operation command source	0, 1	1	0	49	
	339	Communication speed command source	0 to 2	1	0	49	
	340	Communication startup mode selection	0, 1, 10	1	0	40	
	342	Communication EEPROM write selection	0, 1	1	0	42	
	343	Communication error count	—	1	0	42	
—	374	Overspeed detection level	0 to 400Hz, 9999	0.01Hz	9999	49	
Second motor constant	450	Second applied motor	0, 1, 9999	1	9999	38	
Remote Output	495	Remote output selection	0, 1, 10, 11	1	0	49	
	496	Remote output data 1	0 to 4095	1	0	49	
—	502	Stop mode selection at communication error	0 to 3	1	0	42	
Maintenance	503	Maintenance timer	0 (1 to 9998)	1	0	49	
	504	Maintenance timer alarm output set time	0 to 9998, 9999	1	9999	49	
—	505	Speed setting reference	1 to 120Hz	0.01Hz	60Hz	34	
Communication	549	Protocol selection	0, 1	1	0	42	
	551	PU mode operation command source selection	2, 4, 9999	1	9999	49	
—	552	Frequency jump range	0 to 30Hz, 9999	0.01Hz	9999	34	
PID operation	553	PID deviation limit	0 to 100%, 9999	0.1%	9999	44	
	554	PID signal operation selection	0 to 3, 10 to 13	1	0	44	
Current average time monitor	555	Current average time	0.1 to 1s	0.1s	1s	50	
	556	Data output mask time	0 to 20s	0.1s	0s	50	
	557	Current average value monitor signal output reference current	0 to 500A	0.01A	Rated inverter current	50	
—	561	PTC thermistor protection level	0.5 to 30k Ω , 9999	0.01k Ω	9999	31	
—	563	Energization time carrying-over times	(0 to 65535)	1	0	35	
—	564	Operating time carrying-over times	(0 to 65535)	1	0	35	
—	571	Holding time at a start	0 to 10s, 9999	0.1s	9999	31	
PID operation	575	Output interruption detection time	0 to 3600s, 9999	0.1s	1s	44	
	576	Output interruption detection level	0 to 400Hz	0.01Hz	0Hz	44	
	577	Output interruption cancel level	900 to 1100%	0.1%	1000%	44	
—	611	Acceleration time at a restart	0 to 3600s, 9999	0.1s	9999	36	
—	653	Speed smoothing control	0 to 200%	0.1%	0%	50	
—	665	Regeneration avoidance frequency gain	0 to 200%	0.1%	100%	50	
—	779	Operation frequency during communication error	0 to 400Hz, 9999	0.01Hz	9999	42	
—	791	Acceleration time in low-speed range	0 to 3600s, 9999	0.1s	9999	31	
—	792	Deceleration time in low-speed range	0 to 3600s, 9999	0.1s	9999	31	
—	799	Pulse increment setting for output power	0.1kWh, 1kWh, 10kWh, 100kWh, 1000kWh	0.1kWh	1kWh	51	
—	800	Control method selection	9, 30	1	30	51	

Function	Parameter	Name	Setting Range	Minimum Setting Increments	Initial Value	Refer to Page	Customer Setting
Adjustment function	820	Speed control P gain 1	0 to 1000%	1%	25%	51	
	821	Speed control integral time 1	0 to 20s	0.001s	0.333s	51	
—	870	Speed detection hysteresis	0 to 5Hz	0.01Hz	0Hz	34	
Protective functions	872	Input phase loss protection selection	0, 1	1	0	47	
Regeneration avoidance function	882	Regeneration avoidance operation selection	0 to 2	1	0	50	
	883	Regeneration avoidance operation level	300 to 800V	0.1V	400/780V *5	50	
	885	Regeneration avoidance compensation frequency limit value	0 to 30Hz, 9999	0.01Hz	6Hz	50	
	886	Regeneration avoidance voltage gain	0 to 200%	0.1%	100%	50	
Free parameter	888	Free parameter 1	0 to 9999	1	9999	51	
	889	Free parameter 2	0 to 9999	1	9999	51	
Energy saving monitor	891	Cumulative power monitor digit shifted times	0 to 4, 9999	1	9999	35	
	892	Load factor	30 to 150%	0.1%	100%	52	
	893	Energy saving monitor reference (motor capacity)	0.4 to 15kW	0.01kW	Rated inverter capacity	52	
	894	Control selection during commercial power-supply operation	0 to 3	1	0	52	
	895	Power saving rate reference value	0, 1, 9999	1	9999	52	
	896	Power unit cost	0 to 500, 9999	0.01	9999	52	
	897	Power saving monitor average time	0, 1 to 1000h, 9999	1h	9999	52	
	898	Power saving cumulative monitor clear	0, 1, 10, 9999	1	9999	52	
	899	Operation time rate (estimated value)	0 to 100%, 9999	0.1%	9999	52	
Calibration parameters	C0 (900) *7	FM terminal calibration	—	—	—	52	
	C2 (902) *7	Terminal 2 frequency setting bias frequency	0 to 400Hz	0.01Hz	0Hz	43	
	C3 (902) *7	Terminal 2 frequency setting bias	0 to 300%	0.1%	0%	43	
	125 (903) *7	Terminal 2 frequency setting gain frequency	0 to 400Hz	0.01Hz	60Hz	43	
	C4 (903) *7	Terminal 2 frequency setting gain	0 to 300%	0.1%	100%	43	
	C5 (904) *7	Terminal 4 frequency setting bias frequency	0 to 400Hz	0.01Hz	0Hz	43	
	C6 (904) *7	Terminal 4 frequency setting bias	0 to 300%	0.1%	20%	43	
	126 (905) *7	Terminal 4 frequency setting gain frequency	0 to 400Hz	0.01Hz	60Hz	43	
	C7 (905) *7	Terminal 4 frequency setting gain	0 to 300%	0.1%	100%	43	
	C22 (922) *6*7	Frequency setting voltage bias frequency (built-in potentiometer)	0 to 400Hz	0.01Hz	0Hz	43	
	C23 (922) *6*7	Frequency setting voltage bias (built-in potentiometer)	0 to 300%	0.1%	0%	43	
	C24 (923) *6*7	Frequency setting voltage gain frequency (built-in potentiometer)	0 to 400Hz	0.01Hz	60Hz	43	
	C25 (923) *6*7	Frequency setting voltage gain (built-in potentiometer)	0 to 300%	0.1%	100%	43	

Features

Connection example

Standard specs.

Outline dimensions

Terminal connection diagrams
Terminal specs.Operation panel
Parameter unit
FR Configurator

Parameter list

Parameter descriptions

Protective functions

Options

Precautions

Motor

IPM motor control

Compatibility

Warranty

Function	Parameter	Name	Setting Range	Minimum Setting Increments	Initial Value	Refer to Page	Customer Setting
PID operation	C42 (934)*7	PID display bias coefficient	0 to 500, 9999	0.01	9999	44	
	C43 (934)*7	PID display bias analog value	0 to 300%	0.1%	20%	44	
	C44 (935)*7	PID display gain coefficient	0 to 500, 9999	0.01	9999	44	
	C45 (935)*7	PID display gain analog value	0 to 300%	0.1%	100%	44	
PU	990	PU buzzer control	0, 1	1	1	52	
	991	PU contrast adjustment	0 to 63	1	58	53	
—	997	Fault initiation	16 to 18, 32 to 34, 48, 49, 64, 81, 82, 96, 97, 112, 128, 129, 144, 145, 176 to 178, 192, 196, 197, 199, 201, 208, 230, 245, 9999	1	9999	53	
—	⊙ 998	IPM parameter initialization	0, 1, 12, 101, 112	1	0	77	
—	⊙ 999	Automatic parameter setting	10, 20, 21, 9999	1	9999	53	
Clear parameters	Pr.CL	Parameter clear	0, 1	1	0	53	
	ALLC	All parameter clear	0, 1	1	0	53	
	Er.CL	Faults history clear	0, 1	1	0	53	
—	Pr.CH	Initial value change list	—	—	—	53	
—	⊙ IPM	IPM parameter initialization	0, 1, 12	1	0	77	
—	⊙ AUTO	Automatic parameter setting	—	—	—	53	

*1 Differ according to capacities.

6%: 0.75K or lower

4%: 1.5K to 3.7K

3%: 5.5K, 7.5K

2%: 11K, 15K

*2 Differ according to capacities.

5s: 7.5K or lower

15s: 11K or higher

*3 Differ according to capacities.

10s: 7.5K or lower

30s: 11K or higher

*4 Differ according to capacities.

4%: 7.5K or lower

2%: 11K or higher

*5 The initial value differs according to the voltage class. (200V class / 400V class)

*6 Set this parameter when calibrating the operation panel built-in potentiometer for the FR-E500 series operation panel (PA02) connected with cable.

*7 The parameter number in parentheses is the one for use with the operation panel (PA02) for the FR-E500 series or parameter unit (FR-PU04/FR-PU07).

In the following section, the following marks indicate the operable controls:

- V/F** V/F control (General-purpose motor),
- GP MFVC** General-purpose magnetic flux vector control (General-purpose motor),
- IPM** IPM motor control (dedicated IPM motor). (Parameters without any marks are valid for all controls.)

Also the following marks indicate parameter types:

- Pr.** Simple mode parameters, **Pr.** Extended parameters

Pr. 0, Pr. 46

Manual torque boost **V/F**

Pr.0 Torque boost *Pr.46 Second torque boost*

You can compensate for a voltage drop in the low-frequency region to improve motor torque reduction in the low-speed region.

- Motor torque in the low-frequency range can be adjusted to the load to increase the starting motor torque.
- The RT signal switches between two start torque boost settings.
- Enabled only under V/F control.

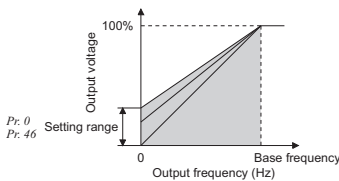

Pr.0 Initial Value		When using the Mitsubishi constant torque motor
0.75K or lower	6%	←
1.5K to 3.7K	4%	←
5.5K, 7.5K	3%	2%*
11K, 15K	2%	←

* If the initial set Pr. 71 value is changed to the setting for use with a constant-torque motor, the Pr. 0 setting changes to the corresponding value in above.

Pr. 1, 2, Pr. 18

Maximum/minimum frequency

Pr.1 Maximum frequency *Pr.2 Minimum frequency*
Pr.18 High speed maximum frequency

You can limit the motor speed.

- Clamp the upper and lower limits of the output frequency.
- To operate with a frequency higher than 120Hz under V/F control or General-purpose magnetic flux vector control, set the upper limit for the output frequency in Pr. 18.

(When Pr. 18 is set, Pr. 1 automatically switches to the frequency of Pr. 18. Also, when Pr. 1 is set, Pr. 18 is automatically changed to the frequency set in Pr. 1.)

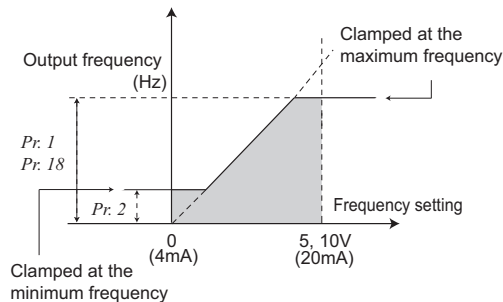

Pr. 3, Pr. 19, 47

Base frequency, voltage **V/F**

Pr.3 Base frequency *Pr.19 Base frequency voltage*
Pr.47 Second V/F (base frequency)

- Used to adjust the inverter outputs (voltage, frequency) to the motor rating.
- When operating a standard motor, generally set the rated frequency of the motor to Pr. 3 Base frequency. When running the motor using commercial power supply-inverter switch-over operation, set Pr. 3 to the same value as the power supply frequency.
- When you want to change the base frequency when switching multiple motors with one inverter, use the Pr. 47 Second V/F (base frequency).
- Use Pr. 19 Base frequency voltage to set the base voltage (e.g. rated motor voltage).
- Enabled only under V/F control.

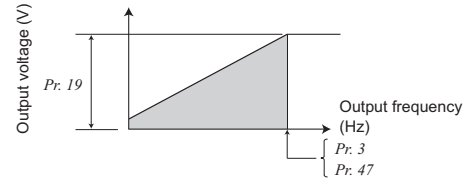

Pr. 4 to 6, Pr. 24 to 27, 232 to 239

Multi-speed setting operation

- Pr.4 Multi-speed setting (high speed)* *Pr.5 Multi-speed setting (middle speed)*
- Pr.6 Multi-speed setting (low speed)* *Pr.24 Multi-speed setting (speed 4)*
- Pr.25 Multi-speed setting (speed 5)* *Pr.26 Multi-speed setting (speed 6)*
- Pr.27 Multi-speed setting (speed 7)* *Pr.232 Multi-speed setting (speed 8)*
- Pr.233 Multi-speed setting (speed 9)* *Pr.234 Multi-speed setting (speed 10)*
- Pr.235 Multi-speed setting (speed 11)* *Pr.236 Multi-speed setting (speed 12)*
- Pr.237 Multi-speed setting (speed 13)* *Pr.238 Multi-speed setting (speed 14)*
- Pr.239 Multi-speed setting (speed 15)*

Can be used to change the preset speed in the parameter with the contact signals.

Any speed can be selected by merely turning on-off the contact signals (RH, RM, RL, REX signals).

- The inverter operates at frequencies set in Pr. 4 when RH signal is on, Pr. 5 when RM signal is on and Pr. 6 when RL signal is on.
- Frequency from speed 4 to speed 15 can be set according to the combination of the RH, RM, RL and REX signals. Set the running frequencies to Pr. 24 to Pr. 27, Pr. 232 to Pr. 239. (In the initial value setting, speed 4 to 15 are unavailable.)

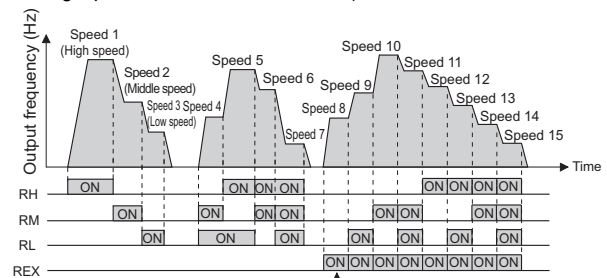

* When turning RH, RM and RL off and REX on with "9999" set in Pr. 232 "multi speed setting (8 speed)", the inverter operates at frequency set in Pr. 6.

Pr. 7, 8, Pr. 20, 44, 45, 791, 792
Acceleration/deceleration time setting

- Pr.7 Acceleration time Pr.8 Deceleration time
- Pr.20 Acceleration/deceleration reference frequency
- Pr.44 Second acceleration time Pr.45 Second deceleration time
- Pr.791 Acceleration time in low-speed range IPM
- Pr.792 Deceleration time in low-speed range IPM

Used to set motor acceleration/deceleration time. Set a larger value for a slower speed increase/decrease or a smaller value for a faster speed increase/decrease.

- Use Pr. 7 Acceleration time to set the acceleration time required to reach Pr. 20 Acceleration/deceleration reference frequency from 0Hz.
- Use Pr. 8 Deceleration time to set the deceleration time required to stop from the Pr. 20 Acceleration/deceleration reference frequency.

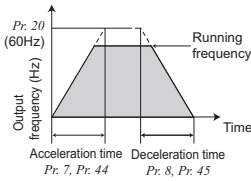

- If torque is required in the low-speed range (rated motor frequency/10) under IPM motor control, set the Pr.791 Acceleration time in low-speed range and Pr.792 Deceleration time in low-speed range settings higher than the Pr.7 Acceleration time and Pr.8 Deceleration time settings so that the slow acceleration/deceleration is performed in the low-speed range. (Refer to page 78 for the rated motor frequency.)

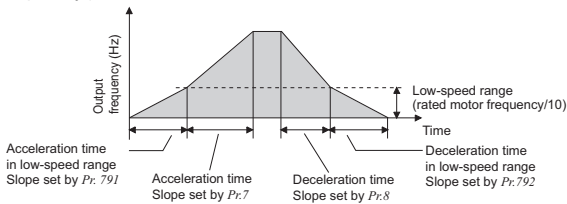

Pr. 9, Pr. 51, 561
Motor protection from overheat (electronic thermal relay function, PTC thermistor protection)

- Pr.9 Electronic thermal O/L relay
- Pr.51 Second electronic thermal O/L relay V/F GP MFVC
- Pr.561 PTC thermistor protection level

Set the current of the electronic overcurrent protection to protect the motor from overheat. This feature provides the optimum protective characteristics, including reduced motor cooling capability, at low speed.

- This function detects the overload (overheat) of the motor, stops the operation of the inverter's output transistor, and stops the output.
- Set the rated current [A] of the motor in Pr.9. (If the General-purpose motor has both 50Hz and 60Hz ratings and the Pr.3 Base frequency is set to 60Hz, set the 1.1 times of the 60Hz rated motor current.)
- When using a motor with an external thermal relay, etc., set "0" in Pr.9 to make the electronic thermal relay function invalid. (Note that the output transistor protection of the inverter (E.THT) functions.)
- When using a Mitsubishi constant-torque motor
 - 1) Set "1" or "13", "50", "53" in any of Pr. 71. (This provides a 100% continuous torque characteristic in the low-speed range.)
 - 2) Set the rated current of the motor in Pr. 9.
- When the RT signal is ON in a General-purpose motor operation, thermal protection is provided based on the Pr. 51 setting. Use this function when rotating two motors of different rated currents individually by a single inverter. (When rotating two motors together, use external thermal relays.)

- When the motor has a built-in PTC thermistor, the output can be input to the terminal 2 and terminal 10. When the input from the PTC thermistor reaches the resistance setting in Pr.561 PTC thermistor protection level, the PTC thermal error signal (E.PTC) is output and the inverter trips.

Pr. 10 to 12
DC injection brake of General-purpose motor control V/F GP MFVC

- Pr.10 DC injection brake operation frequency Pr.11 DC injection brake operation time
- Pr.12 DC injection brake operation voltage

The DC injection brake can be operated at a motor stop to adjust the stop timing and braking torque.

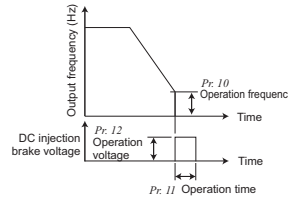

Pr.12 Initial Value		When Using the Mitsubishi Constant Torque Motor
3.7K or lower	4%	←
5.5K, 7.5K	4%	2%*
11K, 15K	2%	←

* If the Pr. 71 initial value is changed to the setting for use with a constant-torque motor, the Pr. 12 setting changes to the corresponding value in the above table.

Pr. 10, 11
DC injection brake of IPM motor control IPM

- Pr.10 DC injection brake operation frequency Pr.11 DC injection brake operation time

At a motor stop, DC injection brake operates to apply braking torque to the motor.

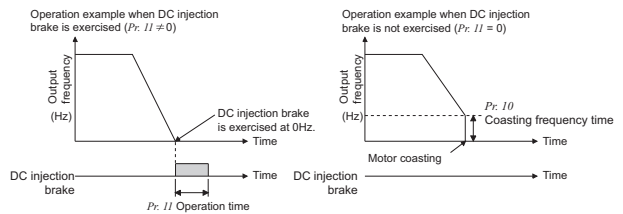

Pr. 13, 571
Starting frequency V/F GP MFVC

- Pr.13 Starting frequency Pr.571 Holding time at a start

You can set the starting frequency and hold the set starting frequency for a certain period of time. Set these functions when you need the starting torque or want smooth motor drive at a start.

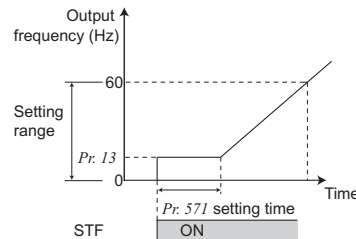

Pr. 13
Minimum motor rotation frequency

IPM

Pr.13 Starting frequency

Set the frequency where the motor starts running.
 Set the deadband in the low-speed range to eliminate noise and offset deviation when setting a frequency with analog input.

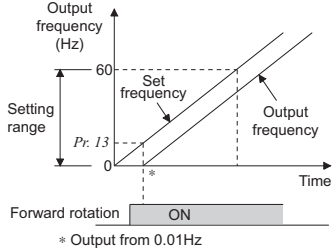

Pr. 14
V/F pattern matching applications

V/F

Pr.14 Load pattern selection

You can select the optimum output characteristic (V/F characteristic) for the application and load characteristics.
 Enabled only under V/F control.

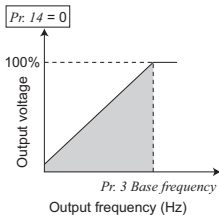

- For constant-torque load (setting "0")
 - At or less than the base frequency voltage, the output voltage varies linearly with the output frequency.
 - Set this value when driving the load whose load torque is constant if the speed varies, e.g. conveyor, cart or roll drive.

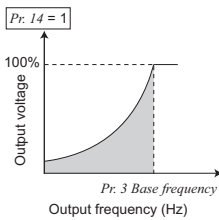

- For variable-torque load (setting "1", initial value)
 - At or less than the base frequency voltage, the output voltage varies with the output frequency in a square curve.
 - Set this value when driving the load whose load torque varies in proportion to the square of the speed, e.g. fan or pump.

Pr. 15, 16
Jog operation

Pr.15 Jog frequency

Pr.16 Jog acceleration/deceleration time

You can set the frequency and acceleration/deceleration time for jog operation. Jog operation can be performed from either the outside or PU.

Can be used for conveyor positioning, test operation, etc.

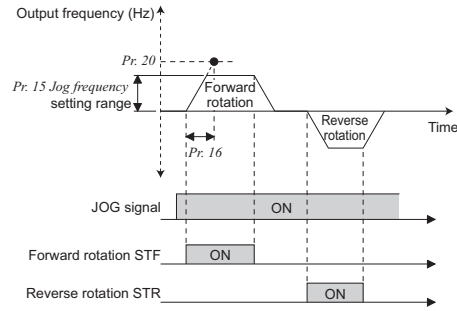

Pr. 17
Logic selection of output stop signal (MRS)

Pr.17 MRS input selection

The inverter output can be shut off by the MRS signal. The logic of the MRS signal can also be selected.

When Pr. 17 is set to "4", the MRS signal from external terminal (output stop) can be changed to the normally closed (NC contact) input, and the MRS signal from communication can be changed to the normally open (NO contact) input.

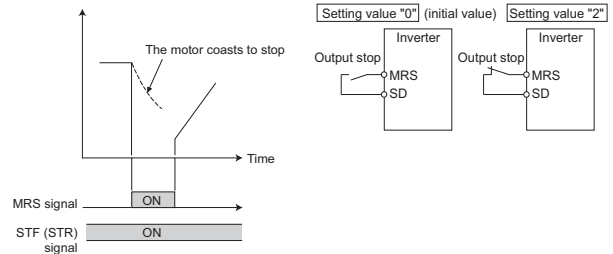

Pr. 18 Refer to the section about Pr.1

Pr. 19 Refer to the section about Pr.3

Pr. 20 Refer to the section about Pr.7

Pr. 22, 23, 48, 66, 154, 156, 157
Stall prevention operation

Pr.22 Stall prevention operation level
 Pr.23 Stall prevention operation level compensation factor at double speed



Pr.48 Second stall prevention operation current
 Pr.66 Stall prevention operation reduction starting frequency



Pr.154 Voltage reduction selection during stall prevention operation



Pr.156 Stall prevention operation selection Pr.157 OL signal output timer

This function monitors the output current and automatically changes the output frequency to prevent the inverter from coming to trip due to overcurrent, overvoltage, etc. It can also limit stall prevention and fast-response current limit operation during acceleration/deceleration, driving or regeneration.

- **Stall prevention**
 If the output current exceeds the limit value, the output frequency of the inverter is automatically varied to reduce the output current.
- **Fast-response current limit**
 If the current exceeds the limit value, the output of the inverter is shut off to prevent an overcurrent. (V/F control and General-purpose magnetic flux vector control)
- For Pr. 22, set the output current level where the stall prevention is activated. Set the output current level in ratio to the inverter rated current (rated IPM motor current under IPM motor control). Normally set this parameter to 120% (initial value).
- When a General-purpose motor is driven at the rated motor frequency or higher, acceleration may not be possible because the motor current does not increase. If operation is performed in a high frequency range, the current at motor lockup becomes smaller than the rated output current of the inverter, and the protective function (OL) is not executed if the motor is at a stop.
 To improve the operating characteristics of the motor in this case, the stall prevention level can be reduced in the high frequency region. This function is effective for performing operation up to the high speed region on a centrifugal separator etc. Normally, set 60Hz in Pr. 66 and 100% in Pr. 23.
- Setting Pr. 23 Stall prevention operation level compensation factor at double speed = "9999" (initial value) during General-purpose motor operation keeps the stall prevention operation level at the Pr. 22 setting until the frequency goes up to 400Hz.

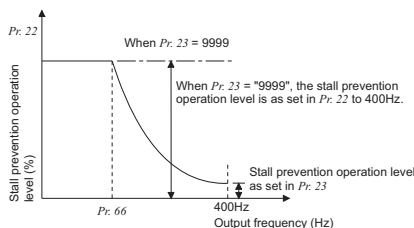

- Set Pr.154 = "11" when the overvoltage protective function (E.OV□) activates during stall prevention operation in an application with large load inertia. Note that turning OFF the start signal (STF/STR) or varying the frequency signal during stall prevention operation may delay the acceleration/deceleration start.
- Stall prevention operation and fast response current restriction function can be restricted according to the operation condition using Pr. 156.
 (The fast-response current limit operation is disabled under IPM motor control.)

Pr. 24 to 27 Refer to the section about Pr.4

Pr. 29
Acceleration/deceleration pattern

Pr.29 Acceleration/deceleration pattern selection

You can set the acceleration/deceleration pattern suitable for application.

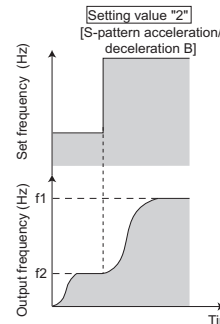
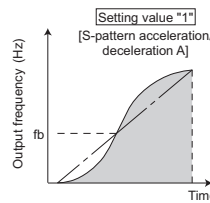
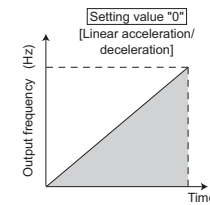

- **Linear acceleration/deceleration (setting "0", initial value)**
 For the inverter operation, the output frequency is made to change linearly (linear acceleration/deceleration) to prevent the motor and inverter from getting excessive stress to reach the set frequency during acceleration, deceleration, etc. when frequency changes.
- **S-pattern acceleration/deceleration A (setting "1")**
 For machine tool spindle applications, etc.
 Use this pattern when acceleration/ deceleration is required in a short time to a high-speed range higher than Pr. 3 Base frequency * (fb)
 * Rated motor frequency under IPM motor control (Refer to page 78)
- **S-pattern acceleration/deceleration B (setting "2")**
 For prevention of load shifting in conveyor and other applications.
 Since acceleration/deceleration is always made in an S shape from current frequency (f2) to target frequency (f1), this function eases shock produced at acceleration/deceleration and is effective for load collapse prevention, etc.

Pr. 30, 70
Selection of regeneration unit

Pr.30 Regenerative function selection Pr.70 Special regenerative brake duty

- When making frequent starts/stops, use the optional brake resistor to increase the regenerative brake duty.
- Use a power regeneration common converter (FR-CV) for continuous operation in regeneration status.
 Use the high power factor converter (FR-HC2) to reduce harmonics, improve the power factor, or continuously use the regenerative status.

Pr.30 setting	Pr.70 setting	Regeneration unit
0 (initial value)	*1	Brake resistor (MRS type, MYS type) Brake unit (FR-BU2) Power regeneration common converter (FR-CV) High power factor converter (FR-HC2)
1	6%	Brake resistor (MYS type) (used at 100% torque/6%ED) *2
	10%	High-duty brake resistor (FR-ABR)
2	-	High power factor converter (FR-HC2) (when automatic restart after instantaneous power failure is selected)

*1 The brake duty differs according to the capacity.
 *2 Available only with FR-F720PJ-3.7K.

Pr. 31 to 36, 552
Avoid mechanical resonance points (frequency jump)

- Pr.31 Frequency jump 1A Pr.32 Frequency jump 1B
- Pr.33 Frequency jump 2A Pr.34 Frequency jump 2B
- Pr.35 Frequency jump 3A Pr.36 Frequency jump 3B
- Pr.552 Frequency jump range

When it is desired to avoid resonance attributable to the natural frequency of a mechanical system, these parameters allow resonant frequencies to be jumped.

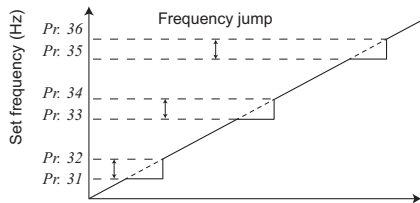

- Up to three areas may be set, with the jump frequencies set to either the top or bottom point of each area.
- The value set to 1A, 2A or 3A is a jump point and operation in the jump zone is performed at these frequencies.
- Frequency jump is not performed if the initial value is set to "9999".
- During acceleration/deceleration, the running frequency within the set area is valid.
- By using the Pr.552 setting, a total of six frequency jump ranges can be set to the Pr.31 to Pr.36 frequency settings.

Pr. 37, 144, 505
Speed display and speed setting

- Pr.37 Speed display Pr.144 Speed setting switchover
- Pr.505 Speed setting reference

The monitored item and the frequency setting displayed on the operation panel and PU (FR-PU04/FR-PU07) can be switched among the motor speed, machine speed, etc.

- Each monitor and setting are determined according to the combination of Pr. 37 and Pr. 144. (The units within the thick frame are the initial values.)
- To display a machine speed, set Pr.37 to the machine speed at the frequency set in Pr. 505, and set Pr. 144 to the number of motor poles (2, 4, 6, 8, 10).

Pr.37 setting	Pr.144 setting	Output Frequency Monitor	Set Frequency Monitor	Frequency Setting	Parameter Setting
0 (initial value)	2 to 10	0.01Hz	0.01Hz	0.01Hz	0.01Hz
	102 to 110	1r/min *	1r/min *	1r/min *	1r/min *
0.01 to 9998	2 to 10	0.001 (Machine speed *)	0.001 (Machine speed *)	0.001 (Machine speed *)	0.01Hz
	102 to 110	0.01Hz	0.01Hz	0.01Hz	0.01Hz

* Motor speed r/min conversion formula
 Frequency × 120/number of motor poles (Pr.144)
 Machine speed conversion formula
 Pr.37 × frequency/Pr.505 setting (Hz)
 For Pr.144 in the above formula, the value is "Pr.144 - 100" when "102 to 110" is set in Pr.144 and the value is "4" when Pr.37 = 0 and Pr.144 = 0.
 Pr.505 is always set as frequency (Hz).

Pr. 40
RUN key rotation direction selection

- Pr.40 RUN key rotation direction selection

- Used to choose the direction of rotation by operating RUN key of the operation panel.

Pr.40 setting	Description
0	Forward rotation
1	Reverse rotation

Pr. 41 to 43, 870
Detection of output frequency (SU, FU signal)

- Pr.41 Up-to-frequency sensitivity Pr.42 Output frequency detection
- Pr.43 Output frequency detection for reverse rotation
- Pr.870 Speed detection hysteresis

The inverter output frequency is detected and output at the output signals.

- If the set frequency is considered as 100%, output frequency can be adjusted between 0% and ±100% with Pr. 41.
- This parameter can be used to ensure that the running frequency has been reached to provide the operation start signal etc. for related equipment.

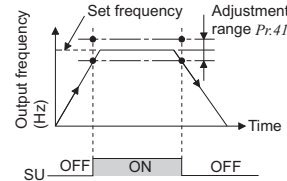

- When the output frequency reaches or exceeds the setting of Pr.42, the output frequency detection signal (FU) is output. This function can be used for electromagnetic brake operation, open signal, etc.
- When the detection frequency is set in Pr.43, frequency detection for reverse rotation use only can also be set. This function is effective for switching the timing of electromagnetic brake operation between forward rotation (rise) and reverse rotation (fall) during vertical lift operation, etc.

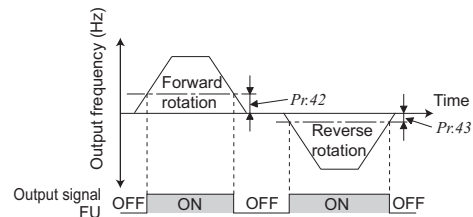

- Setting a hysteresis width at the output frequency in Pr.870 prevents chattering of the speed detection signals.

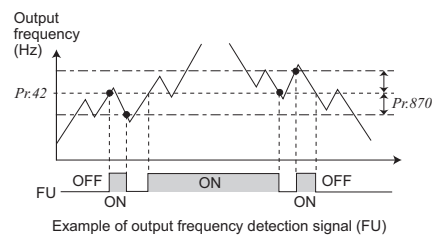

Example of output frequency detection signal (FU)

Pr. 44, 45 Refer to the section about Pr.7

Pr. 46 Refer to the section about Pr.0

Pr. 47 Refer to the section about Pr.3

Pr. 48 Refer to the section about Pr.22

Pr. 51 Refer to the section about Pr.9

Pr. 52, 54, 170, 171, 268, 563, 564, 891
DU/PU monitor change, cumulative monitor clear

- Pr.52 DU/PU main display data selection* *Pr.54 FM terminal function selection*
- Pr.170 Watt-hour meter clear* *Pr.171 Operation hour meter clear*
- Pr.268 Monitor decimal digits selection* *Pr.563 Energization time carrying-over times*
- Pr.564 Operating time carrying-over times*
- Pr.891 Cumulative power monitor digit shifted times*

The monitor to be displayed on the main screen of the operation panel and parameter unit (FR-PU04/FR-PU07) can be selected.

Types of Monitor	Increments	Pr.52 setting		Pr.54 (FM) setting	Full Scale Value
		operation panel LED	PU main monitor		
Output frequency	0.01Hz	0/100		1	Pr.55
Output current	0.01A	0/100		2	Pr.56
Output voltage	0.1V	0/100		3	200V class: 400V 400V class: 800V
Alarm display	—	0/100		—	—
Frequency setting	0.01Hz	5	*1	5	Pr.55
Converter output voltage	0.1V	8	*1	8	200V class: 400V 400V class: 800V
Regenerative brake duty	0.1%	9	*1	9	Brake duty set in Pr. 30 and Pr. 70
Electronic thermal relay function load factor	0.1%	10	*1	10	Electronic thermal relay function operation level
Output current peak value	0.01A	11	*1	11	Pr.56
Converter output voltage peak value	0.1V	12	*1	12	200V class: 400V 400V class: 800V
Output power	0.01kW	14	*1	14	Rated inverter power × 2
Input terminal status	—	—	*1	—	—
Output terminal status	—	—	*1	—	—
Cumulative energization time *2	1h	20		—	—
Reference voltage output	—	—	—	21	—
Actual operation time *2, *3	1h	23		—	—
Motor load factor	0.1%	24		24	200%
Cumulative power *5	0.01kWh*4	25		—	—
Power saving effect	Variable according to parameters	50		50	Inverter capacity
Cumulative saving power		51		—	—
PID set point	0.1%	52		52	100%
PID measured value	0.1%	53		53	100%
PID deviation value	0.1%	54		—	—
Inverter I/O terminal monitor	—	55	—	—	—
Motor thermal load factor	0.1%	61		61	Thermal relay operation level (100%)
Inverter thermal load factor	0.1%	62		62	Thermal relay operation level (100%)
PTC thermistor resistance	0.01kΩ	64		—	—

- *1 Selected by the parameter unit (FR-PU04/FR-PU07)
- *2 The cumulative energization time and actual operation time are accumulated from 0 to 65535 hours, then cleared, and accumulated again from 0.
When the operation panel is used, up to 65.53 (65530h) is displayed as 1h=0.001 and then accumulated from 0.
- *3 The actual operation time is not added up if the cumulative operation time before power supply-off is less than 1h.
- *4 When using the parameter unit (FR-PU04/FR-PU07), "kW" is displayed.
- *5 Since the panel display of the operation panel is 4 digits in length, the monitor value of more than "9999" is displayed as "----".

- The cumulative power monitor value digit can be shifted to the right by the number set in Pr. 891.
- By setting "0" in Pr. 170, the cumulative power monitor can be cleared.
- You can check the numbers of cumulative energization time monitor exceeded 65535h with Pr. 563 and the numbers of actual operation time monitor exceeded 65535h with Pr. 564.
- Writing "0" in Pr. 171 clears the actual operation time monitor.

Pr.268 setting	Description
9999 (initial value)	No function
0	When 1 or 2 decimal places (0.1 increments or 0.01 increments) are monitored, the decimal places are dropped and the monitor displays an integer value (1 increments). The monitor value of 0.99 or less is displayed as 0.
1	When 2 decimal places (0.01 increments) are monitored, the 0.01 decimal place is dropped and the monitor displays the first decimal place (0.1 increments). When the monitor display digit is originally in 1 increments, it is displayed unchanged in 1 increments.

- When Pr. 52 is set to "100", the set frequency monitor is displayed during a stop and the output frequency monitor is displayed during operation. (LED of Hz flickers during stop and is lit during operation.)

	Pr.52		
	0	100	
	During operation/stop	During stop	During running
Output frequency	Output frequency	Set frequency *	Output frequency
Output current	Output current		
Output voltage	Output voltage		
Fault display	Alarm display		

- * The set frequency displayed indicates the frequency to be output when the start command is ON. Different from the frequency setting displayed when Pr. 52 = "5", the value based on maximum/minimum frequency and frequency jump is displayed.

Pr. 55, 56
Terminal FM output monitor change

- Pr.55 Frequency monitoring reference* *Pr.56 Current monitoring reference*

Set the full scale value when monitoring the output from terminal FM.

Monitor *	Reference parameter	Initial Value
Frequency	Pr.55	60Hz
Current	Pr.56	Rated inverter current

- * For the applicable monitor names, refer to the description on Pr.52.

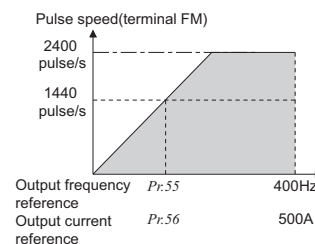

Pr. 30, 57, 58, 162, 165, 299, 611
Automatic restart after instantaneous power failure/flying start under General-purpose motor control V/F GPMFVC

- [Pr.30 Regenerative function selection](#) [Pr.57 Restart coasting time](#)
- [Pr.58 Restart cushion time](#)
- [Pr.162 Automatic restart after instantaneous power failure selection](#)
- [Pr.165 Stall prevention operation level for restart](#)
- [Pr.299 Rotation direction detection selection at restarting](#)
- [Pr.611 Acceleration time at a restart](#)

The inverter can be restarted without stopping the motor under V/F control and General-purpose magnetic flux vector control in the following cases:

- when power comes back on after an instantaneous power failure
- when motor is coasting at start

For the operation under IPM motor control, refer to the next page.

Pr. Number	Setting Range	Description
30	0 (initial value), 1	The motor starts at the starting frequency when MRS (X10) turns ON then OFF
	2	Restart operation is performed when MRS (X10) turns ON then OFF
57	0	1.5K or lower 1s 2.2K to 7.5K or higher..... 2s 11K, 15K 3s The above times are coasting time.
	0.1 to 5s	Set the waiting time for inverter-triggered restart after an instantaneous power failure.
	9999 (initial value)	No restart
58	0 to 60s	Set a voltage starting time at restart.
162	0	Frequency search only performed at the first start
	1 (initial value)	Reduced voltage start only performed at the first start (no frequency search)
	10	Frequency search at every start
	11	Reduced voltage start at every start (no frequency search)
165	0 to 150%	Consider the rated inverter current as 100% and set the stall prevention operation level during restart operation.
299	0 (initial value)	Without rotation direction detection
	1	With rotation direction detection
	9999	When Pr. 78 =0, the rotation direction is detected. When Pr. 78 =1,2, the rotation direction is not detected.
611	0 to 3600s	Set the acceleration time that takes to reach Pr. 20 Acceleration/deceleration reference frequency setting at a restart.
	9999 (initial value)	Acceleration time for restart is the normal acceleration time (e.g. Pr. 7).

- When Pr. 162 = "1 (initial value) or 11", automatic restart operation is performed in a reduced voltage system, where the voltage is gradually risen with the output frequency unchanged from prior to an instantaneous power failure independently of the coasting speed of the motor.

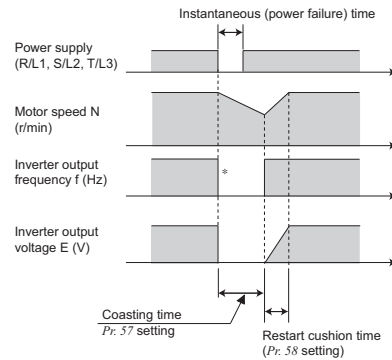

* The output shut off timing differs according to the load condition.

- When "0 or 10" is set in Pr. 162, the inverter smoothly starts after detecting the motor speed upon power restoration. (The motor capacity should be equal to or one rank lower than the inverter capacity)
When using the frequency search, perform offline auto tuning. Also, there is a limit to the wiring length. (Refer to page 70)
- Even when the motor is rotating in the opposite direction, the inverter can be restarted smoothly as the direction of rotation is detected. (You can select whether to make rotation direction detection or not with Pr.299 Rotation direction detection selection at restarting.)

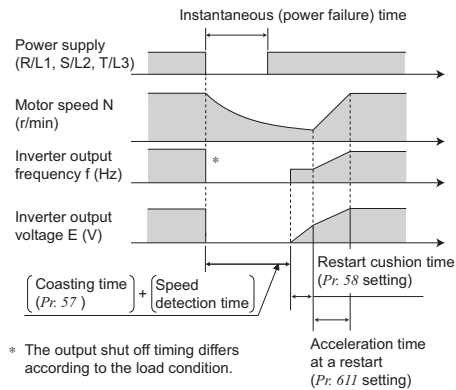

* The output shut off timing differs according to the load condition.

- Restart operation after turning MRS (X10) signal ON then OFF using Pr. 30 can be selected as in the table below. This function is used when the high power factor converter (FR-HC) is used and the automatic restart after instantaneous power failure is selected. (Refer to page 33)

Pr. 57, 162, 611

Automatic restart after instantaneous power failure/flying start under IPM motor control IPM

Pr.57 Restart coasting time
Pr.162 Automatic restart after instantaneous power failure selection
Pr.611 Acceleration time at a restart

The inverter can be restarted without stopping the IPM motor in the following cases:

- When power comes back ON during inverter driving after an instantaneous power failure
- When the motor is coasting at start

For V/F control and General-purpose magnetic flux vector control, refer to the previous page.

Pr. Number	Setting Range	Description
57	0	No waiting time
	0.1 to 5s	Set the waiting time for inverter-triggered restart after an instantaneous power failure.
	9999 (initial value)	No restart
162	0, 1 (initial value)	With frequency search
	10, 11	Frequency search at every start
611	0 to 3600s	Set the acceleration time that takes to reach <i>Pr.20 Acceleration/deceleration reference frequency setting at a restart.</i>
	9999 (initial value)	Acceleration time for restart is the normal acceleration time (e.g. <i>Pr. 7</i>).

● Automatic restart operation selection (*Pr.162*)

The inverter smoothly starts after detecting the motor speed (frequency search) upon power restoration.

During reverse rotation, the inverter can be restarted smoothly as the direction of rotation is detected.

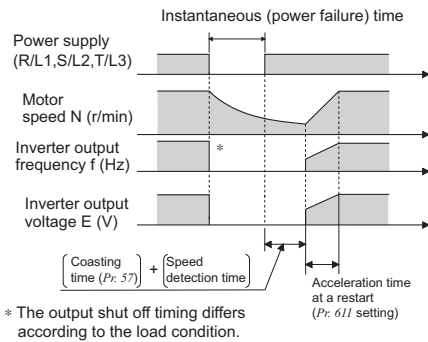

Pr. 59

Remote setting function

Pr.59 Remote function selection

- Even if the operation panel is located away from the enclosure, you can use contact signals to perform continuous variable-speed operation, without using analog signals.
- By merely setting this parameter, you can use the acceleration, deceleration and setting clear functions of the remote speed setter (FR-FK).

Pr.59 setting	Description	
	RH, RM, RL signal function	Frequency setting storage function
0 (initial value)	Multi-speed setting	—
1	Remote setting	Used
2	Remote setting	Not used
3	Remote setting	Not used (Turning STF/STR off clears remotely-set frequency.)

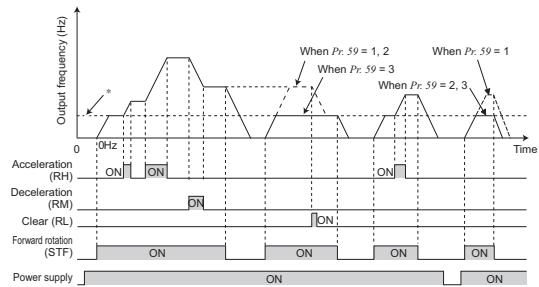

* External running frequency (other than multi-speed operation) or PU running frequency

Pr. 60

Energy saving control selection V/F

Pr.60 Energy saving control selection

Without a fine parameter setting, the inverter automatically performs energy saving operation.

This operation is optimum for fan and pump applications.

Pr.60 setting	Description
0 (initial value)	Normal operation mode
9	Optimum excitation control mode The Optimum excitation control mode is a control system which controls excitation current to improve the motor efficiency to maximum and determines output voltage as an energy saving method. *

* Since output voltage is controlled, output current may slightly increase.

Pr. 65, 67 to 69
Retry function at alarm occurrence

Pr.65 Retry selection *Pr.67 Number of retries at fault occurrence*
Pr.68 Retry waiting time *Pr.69 Retry count display erase*

If an alarm occurs, the inverter resets itself automatically to restart. You can also select the alarm description for a retry.

When selection of automatic restart after instantaneous power failure is selected (*Pr. 57 Restart coasting time ≠ 9999*), restart operation is performed at retry operation as at an instantaneous power failure.

- Use *Pr. 65* to select the alarm to be activated for retries.
 "●" indicates the alarms selected for retry.

Alarm Indication for Retry	Pr.65 Setting					
	0	1	2	3	4	5
E.OC1	●	●		●	●	●
E.OC2	●	●		●	●	
E.OC3	●	●		●	●	●
E.OV1	●		●	●	●	
E.OV2	●		●	●	●	
E.OV3	●		●	●	●	
E.THM	●					
E.THT	●					
E.UVT	●				●	
E. BE	●				●	
E. GF	●				●	
E.OHT	●					
E.PTC	●					
E.OLT	●				●	
E. PE	●				●	
E.ILF	●				●	
E.CDO	●				●	
E.PID	●				●	
E.OS *	●				●	
E.SOT *	●	●		●	●	●

* This function is available only under IPM motor control.

- Set the number of retries at alarm occurrence in *Pr. 67*.

Pr.67 Setting	Description
0 (initial value)	No retry function
1 to 10	Set the number of retries at alarm occurrence. An alarm output is not provided during retry operation.
101 to 110	Set the number of retries at alarm occurrence. (The setting value of minus 100 is the number of retries.) An alarm output is provided during retry operation.

- Use *Pr. 68* to set the waiting time from when an inverter alarm occurs until a retry is made in the range 0.1 to 600s.
- Reading the *Pr. 69* value provides the cumulative number of successful restart times made by retry. (This can be cleared by setting "0".)

Pr. 66 Refer to the section about *Pr.22*

Pr. 67 to 69 Refer to the section about *Pr.65*

Pr. 70 Refer to the section about *Pr.30*

Pr. 71, 450
Use the constant torque motor (applied motor)

Pr.71 Applied motor

Pr.450 Second applied motor

Setting of the used motor selects the thermal characteristic appropriate for the motor.

Setting is required when using a constant-torque motor or IPM motor. Thermal characteristic of the electronic thermal relay function suitable for the motor is set.

Pr.71, Pr.450 setting		Used motor	Thermal Characteristic of the Electronic Thermal Relay Function		
Pr.71	Pr.450		Standard	Constant torque	IPM
0		Standard motor (such as SF-JR)	○		
1		Mitsubishi constant-torque motor (such as SF-JRCA)		○	
40	—	Mitsubishi high-efficiency motor (SF-HR)	○		
50	—	Mitsubishi constant-torque motor (SF-HRCA)		○	
3	—	Standard motor	○		
13	—	Constant-torque motor		○	
23	—	Mitsubishi standard motor (SF-JR 4P 1.5kW or less)		○	
43	—	Mitsubishi high-efficiency motor (SF-HR)	○		
53	—	Mitsubishi constant-torque motor (SF-HRCA)		○	
120	—	High-efficiency IPM motor (MM-EF)			○
210	—	High-efficiency IPM motor (MM-EFS)			○
—	9999	Without second applied motor (<i>Pr.450</i> initial value)			

- For the 5.5K and 7.5K, the *Pr. 0 Torque boost* and *Pr. 12 DC injection brake operation voltage* settings are automatically changed according to the *Pr. 71* setting as follows.

Automatic Change Parameter	Standard Motor Setting *1	Constant-torque Motor Setting *2
<i>Pr. 0</i>	3%	2%
<i>Pr. 12</i>	4%	2%

*1 *Pr.71* setting: 0, 3, 23, 40, 43, 120, 210

*2 *Pr.71* setting: 1, 13, 50, 53

Features
 Connection example
 Standard specs.
 Outline dimensions
 Terminal connection diagrams
 Terminal specs.
 Operation panel
 Parameter unit
 FR Configurator
 Parameter list
 Parameter descriptions
 Protective functions
 Options
 Precautions
 Motor
 IPM motor control
 Compatibility
 Warranty

Pr. 72, 240, 260

Carrier frequency and Soft-PWM selection

*Pr.72 PWM frequency selection Pr.240 Soft-PWM operation selection
Pr.260 PWM frequency automatic switchover*

You can change the motor sound.

Pr. Number	Setting Range	Description
72	0 to 15	You can change the PWM carrier frequency. The setting values indicate [kHz] values during General-purpose motor control. Note that 0 indicates 0.7kHz, 15 indicates 14.5kHz . Under IPM motor control, the setting values indicate the following [kHz] values. "0 to 4": 2.5kHz "5 to 7": 5kHz "8, 9": 7.5kHz "10 to 12": 10kHz "13 to 15": 12.5kHz
240	0	Soft-PWM is invalid
	1 (initial value)	When the PWM carrier frequency (Pr. 72) is 5kHz or less, the Soft-PWM function is valid.
260	0	PWM carrier frequency is constant independently of load. Note that continuous operation should be performed at less than 85% of the rated inverter current.
	1 (initial value)	Decreases PWM carrier frequency automatically when load increases. If continuous operation is performed at 85% of the rated inverter current or higher and Pr.72 (inverter carrier frequency) ≥ "3" (3kHz) (5kHz or higher under the IPM motor control), E.THT (inverter overload trip) is likely to occur. To avoid that, the carrier frequency is automatically lowered to as low as 2kHz.

Pr. 73, 267

Analog input selection

Pr.73 Analog input selection Pr.267 Terminal 4 input selection

- You can select the function that switches between forward rotation and reverse rotation according to the analog input terminal specifications and analog input level.
- For the terminals 4 used for analog input, voltage input (0 to 5V, 0 to 10V) or current input (4 to 20mA) can be selected. To input a voltage (0 to 5V, 0 to 10V), set the voltage/current input switch to "V". To input current (4 to 20mA), set the voltage/current input switch to "I" and change the parameter (Pr.267).
(indicates the main speed setting)

Pr. 73 setting	Terminal 2 Input	Terminal 4 Input	Reversible Operation
0	0 to 10V	When the AU signal is off ×	Not function
1 (initial value)	0 to 5V		
10	0 to 10V		YES
11	0 to 5V	When the AU signal is on According to the Pr. 267 setting 0:4 to 20mA (initial value) 1:1 to 5V * 2:2 to 10V *	Not function
0	×		
1 (initial value)	×		
10	×	YES	
11	×		

* If the input specification to terminal 4 is changed from the current input (Pr. 267 = "0") to the 0 to 5V or 0 to 10V voltage input (Pr.267 = "1 or 2"), calibrate the input with C6.

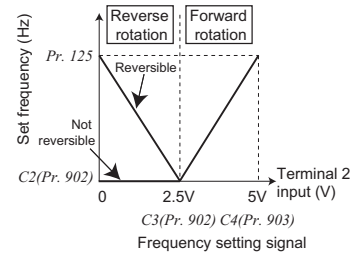

Pr. 74

Noise elimination at the analog input

Pr.74 Input filter time constant

- The time constant of the primary delay filter relative to external frequency command (analog input (terminal 2, 4) signal) can be set.
 - Valid for eliminating noise of the frequency setting circuit.
 - Increase the filter time constant if steady operation cannot be performed due to noise.

A larger setting results in slower response. (The time constant can be set between approximately 5ms to 1s with the setting of 0 to 8.)

Pr. 75
Reset selection, disconnected PU detection

Pr.75 Reset selection/disconnected PU detection/PU stop selection

You can select the reset input acceptance, disconnected PU (FR-PU04/FR-PU07) connector detection function and PU stop function.

Pr.75 setting	Reset Selection	Disconnected PU Detection	PU Stop Selection
0	Reset input normally enabled.	If the PU is disconnected, operation will be continued as-is.	Pressing decelerates the motor to a stop only in the PU operation mode.
1	Reset input enabled only when the protective function is activated.		
2	Reset input normally enabled.	When the PU is disconnected, the inverter output is shut off.	Pressing decelerates the motor to a stop in any of the PU, external and communication operation modes.
3	Reset input enabled only when the protective function is activated.		
14 (initial value)	Reset input normally enabled.	If the PU is disconnected, operation will be continued as-is.	Pressing decelerates the motor to a stop in any of the PU, external and communication operation modes.
15	Reset input enabled only when the protective function is activated.		
16	Reset input normally enabled.	When the PU is disconnected, the inverter output is shut off.	Pressing decelerates the motor to a stop in any of the PU, external and communication operation modes.
17	Reset input enabled only when the protective function is activated.		

- **Reset selection**
 You can select the operation timing of reset function (RES signal, reset command through communication) input.
- **Disconnected PU detection**
 This function detects that the PU (FR-PU04/FR-PU07) has been disconnected from the inverter for longer than 1s and causes the inverter to provide an alarm output (E.PUE) and come to an alarm stop.
- **PU stop selection**
 In any of the PU operation, External operation and network operation modes, the motor can be stopped by pressing of the PU.

Pr. 77
Prevention of parameter rewrite

Pr.77 Parameter write selection

You can select whether write to various parameters can be performed or not. Use this function to prevent parameter values from being rewritten by misoperation.

Pr.77 setting	Description
0 (initial value)	Write is enabled only during a stop.
1	Parameter write is not enabled.
2	Parameter write is enabled in any operation mode regardless of operation status.

Pr. 78
Prevention of reverse rotation of the motor

Pr.78 Reverse rotation prevention selection

This function can prevent reverse rotation fault resulting from the incorrect input of the start signal.

Pr.78 setting	Description
0 (initial value)	Both forward and reverse rotations allowed
1	Reverse rotation disabled
2	Forward rotation disallowed

When setting parameters, refer to the instruction manual (applied) and understand instructions.

Pr. 79, Pr. 340
Operation mode selection

Pr.79 Operation mode selection

Pr.340 Communication startup mode selection

- Used to select the operation mode of the inverter.
 Mode can be changed as desired among operation using external command signals (External operation), operation from the operation panel and PU (FR-PU04/FR-PU07) (PU operation), combined operation of PU operation and External operation (External/PU combined operation), and Network operation (when RS-485 communication is used).

Pr.79 setting	Description	LED Indication :Off :On		
0 (initial value)	External/PU switchover mode (Press to switch between the PU and External operation mode.) External operation mode at power-on	PU operation mode External operation mode NET operation mode 		
1	Fixed to PU operation mode	PU operation mode 		
2	Fixed to external operation mode Operation can be performed by switching between the External and Net operation mode.	External operation mode NET operation mode 		
3	External/PU combined operation mode 1	External/PU combined operation mode 		
	<table border="1"> <thead> <tr> <th>Running frequency</th> <th>Start signal</th> </tr> </thead> <tbody> <tr> <td>Operation panel and PU (FR-PU04/FR-PU07) setting or external signal input (multispeed setting, across terminals 4 and 5 (valid when AU signal turns ON)).</td> <td>External signal input (terminal STF, STR)</td> </tr> </tbody> </table>		Running frequency	Start signal
Running frequency	Start signal			
Operation panel and PU (FR-PU04/FR-PU07) setting or external signal input (multispeed setting, across terminals 4 and 5 (valid when AU signal turns ON)).	External signal input (terminal STF, STR)			
4	External/PU combined operation mode 2	External/PU combined operation mode 		
	<table border="1"> <thead> <tr> <th>Running frequency</th> <th>Start signal</th> </tr> </thead> <tbody> <tr> <td>External signal input (terminal 2, 4, Jog, multi-speed setting, etc)</td> <td>Input from the operation panel and PU (FR-PU04 / FR-PU07) (())</td> </tr> </tbody> </table>		Running frequency	Start signal
Running frequency	Start signal			
External signal input (terminal 2, 4, Jog, multi-speed setting, etc)	Input from the operation panel and PU (FR-PU04 / FR-PU07) (())			
6	Switch-over mode Switch among PU operation, External operation, and NET operation while keeping the same operation status.	PU operation mode 		
7	External operation mode (PU operation interlock) X12 signal ON Operation mode can be switched to the PU operation mode. (output stop during External operation) X12 signal OFF Operation mode cannot be switched to the PU operation mode.	External operation mode NET operation mode 		

Features

Connection example

Standard specs.

Outline dimensions

Terminal connection diagrams
 Terminal specs.

Operation panel
 Parameter unit
 FR Configurator

Parameter list

Parameter descriptions

Protective functions

Options

Precautions

Motor

IPM motor control

Compatibility

Warranty

- Specify operation mode at power on (Pr.340)
 - When power is switched on or when power comes back on after instantaneous power failure, the inverter can be started up in the Network operation mode.
 - After the inverter has started up in the Network operation mode, parameter write and operation can be performed from a program. Set this mode for communication operation using the inverter RS-485 communication.
 - You can set the operation mode at power on (reset) according to the Pr. 79 and Pr. 340 settings.

Pr.340 setting	Pr.79 setting	Operation mode at Power On, Power Restoration, Reset	Operation Mode Switchover
0 (initial value)	As set in Pr.79.		
1	0	NET operation mode	Can be switched to external, PU or NET operation mode *1
	1	PU operation mode	Fixed to PU operation mode
	2	NET operation mode	Can be switched to external or NET operation mode Switching to PU operation mode disabled
	3, 4	External/PU combined operation mode	Operation mode switching disabled
	6	NET operation mode	Can be switched to external, PU or NET operation mode with operation continued
	7	X12 (MRS) signal ON NET operation mode	Can be switched to external, PU or NET operation mode *1
X12 (MRS) signal OFF External operation mode		Fixed to External operation mode (Forcibly switched to External operation mode.)	
10	0	NET operation mode	Can be switched to PU or NET operation mode *2
	1	PU operation mode	Fixed to PU operation mode
	2	NET operation mode	Fixed to NET operation mode
	3, 4	External/PU combined operation mode	Operation mode switching is disallowed
	6	NET operation mode	Can be switched to PU or NET operation mode with operation continued *2
	7	External operation mode	Fixed to External operation mode (Forcibly switched to External operation mode.)

*1 The operation mode cannot be switched directly between the PU operation mode and Network operation mode.

*2 Operation mode can be changed between the PU operation mode and Network operation mode with  key of the operation panel and X65 signal.

Pr. 80, 71

General-purpose magnetic flux vector control 

Pr.80 Motor capacity

Pr.71 Applied motor

Large starting torque and low speed torque are available with General-purpose magnetic flux vector control.

Parameter Number	Setting Range	Description
71	0, 1, 3, 13, 23, 40, 43, 50, 53, 120, 210	By selecting a standard motor or constant-torque motor, thermal characteristic and motor constants of each motor are set.
80	0.4 to 15kW	Applied motor capacity.
	9999 (initial value)	V/F control

- If the following conditions are not satisfied, select V/F control since malfunction such as insufficient torque and uneven rotation may occur.
 - The motor capacity should be equal to or one rank lower than the inverter capacity.
 - Motor to be used is any of Mitsubishi standard motor (SF-JR 0.4kW or higher), high efficiency motor (SF-HR 0.4kW or higher) or Mitsubishi constant-torque motor (SF-JRCA 4P, SF-HRCA 0.4kW to 15kW). When using a motor other than the above (other manufacturer's motor), perform offline auto tuning without fail.
 - Single-motor operation (one motor run by one inverter) should be performed.
 - The wiring length from inverter to motor should be within 30m. (Perform offline auto tuning in the state where wiring work is performed when the wiring length exceeds 30m.)
Permissible wiring length between inverter and motor differs according to the inverter capacity and setting value of Pr. 72 PWM frequency selection (carrier frequency). Refer to page 70 for the permissible wiring length.

Pr. 82 to 84, 90, 96, 298

Offline auto tuning



- Pr.82 Motor excitation current*
- Pr.83 Rated motor voltage*
- Pr.84 Rated motor frequency*
- Pr.90 Motor constant (R1)*
- Pr.96 Auto tuning setting/status*
- Pr.298 Frequency search gain*

When using motors under General-purpose magnetic flux vector control, the offline auto tuning can be executed to automatically calculate the motor constant.

When executing the offline auto tuning under V/F control, set the motor constant (R1) and the *Pr.298 Frequency search gain* required for the frequency search at the automatic restart after instantaneous power failure.

Parameter Number	Setting Range	Description
96	0 (initial value)	Offline auto tuning is not performed.
	11	Offline auto tuning for General-purpose magnetic flux vector control (motor constant (R1) only)
	21	Offline auto tuning for V/F control (automatic restart after instantaneous power failure (with frequency search))

- You can copy the offline auto tuning data (motor constants) to another inverter with the PU (FR-PU07).
 - Even when motors (other manufacturer's motor, SF-JRC, etc.) other than Mitsubishi standard motor (SF-JR 0.4kW or higher), high efficiency motor (SF-HR 0.2kW or higher), and Mitsubishi constant-torque motor (SF-JRCA 4P, SF-HRCA 0.4kW to 15kW) are used or the wiring length is long (30m or more as a reference), using the offline auto tuning function runs the motor with the optimum operating characteristics.
 - The offline auto tuning conditions
 - A motor is connected.
 - The motor capacity is the same as or one rank lower than the inverter capacity.
 - A high-slip motor, high-speed motor and special motor cannot be tuned.
 - The maximum frequency is 120Hz.
 - As the motor may run slightly, fix the motor securely with a mechanical brake or make sure that there will be no problem in safety if the motor runs.
- *Special caution is required in vertical lift applications.
Note that tuning performance is unaffected even if the motor runs slightly.

Pr. 117 to 124, 342, 343, 502, 549, 779

Initial communication setting

- Pr.117 PU communication station number*
- Pr.118 PU communication speed*
- Pr.119 PU communication stop bit length*
- Pr.120 PU communication parity check*
- Pr.121 Number of PU communication retries*
- Pr.122 PU communication check time interval*
- Pr.123 PU communication waiting time setting*
- Pr.124 PU communication CR/LF selection*
- Pr.342 Communication EEPROM write selection*
- Pr.343 Communication error count*
- Pr.502 Stop mode selection at communication error*
- Pr.549 Protocol selection*
- Pr.779 Operation frequency during communication error*

(1) Initial settings and specifications for RS-485 communication (Pr.117 to Pr.124)

Used to perform required settings for RS-485 communication between the inverter and personal computer.

- There are two different communications: communication using the PU connector of the inverter and communication using the RS-485 terminals.
- You can perform parameter setting, monitor, etc. using the Mitsubishi inverter protocol or Modbus-RTU protocol.
- To make communication between the personal computer and inverter, initialization of the communication specifications must be made to the inverter.
Data communication cannot be made if the initial settings are not made or there is any setting error.

Pr. Number	Setting Range	Description
117	0 to 31 (0 to 247) *	Specify the inverter station number. Set the inverter station numbers when two or more inverters are connected to one personal computer
118	48, 96, 192, 384	Set the communication speed. The setting value ×100 equals the communication speed. For example, the communication speed is 19200bps when the setting value is "192".
119	0	Stop bit length 1 bit
	1 (initial value)	2 bits
	10	1 bit
	11	2 bits
120	0	Without parity check
	1	With odd parity check
	2 (initial value)	With even parity check
121	0 to 10	Set the permissible number of retries at occurrence of a data receive error. If the number of consecutive errors exceeds the permissible value, the inverter will come to trip.
	9999	If a communication error occurs, the inverter will not come to trip.
122	0 (initial value)	RS-485 communication can be made. Note that a communication fault (E.PUE) occurs as soon as the inverter is switched to the operation mode with command source. (NET operation mode at initial value)
	0.1 to 999.8s	Set the interval of communication check time. If a no-communication state persists for longer than the permissible time, the inverter will come to trip.
	9999	No communication check
123	0 to 150ms	Set the waiting time between data transmission to the inverter and response.
	9999 (initial value)	Set with communication data.
124	0	Without CR/LF
	1 (initial value)	With CR
	2	With CR/LF

* When making communication via the Modbus-RTU protocol (*Pr.549* = "1"), the setting range is as indicated in parentheses.

Features
 Connection example
 Standard specs.
 Outline dimensions
 Terminal connection diagrams
 Terminal specs.
 Operation panel
 Parameter unit
 FR Configurator
 Parameter list
 Parameter descriptions
 Protective functions
 Options
 Precautions
 Motor
 IPM motor control
 Compatibility
 Warranty

(2) Communication EEPROM write selection (Pr.342)

When parameter write is performed from PU connector connected to the inverter, parameter's storage device can be changed from EEPROM + RAM to only RAM. When performing parameter change frequently, set "1" in Pr. 342.

(3) Modbus-RTU communication specifications (Pr.343, Pr.549)

Pr. Number	Setting Range	Description
343	—	Display the number of communication errors during Modbus-RTU communication. (Reading only)
549	0 (initial value)	Mitsubishi inverter (computer link) protocol
	1	Modbus-RTU protocol

(4) operation selection at communication error (Pr.502, Pr.779)

For communication using RS-485 terminals, operation at a communication error can be selected. The operation is active under the Network operation mode.

Pr. Number	Setting Range	Description			
		At error occurrence	Indication	Fault output	Aterror removal
502	0 (initial value)	Coasts to stop	E.PUE	Output	Stops (E.PUE)
	1	Decelerates to stop	E.PUE after stop	Output after stop	Stops (E.PUE)
	2	Decelerates to stop	E.PUE after stop	Without output	Restarts
	3	Continues running at Pr.779	—	Without output	Operates normally
779	0 to 400Hz	Motor runs at the specified frequency at a communication error.			
	9999 (initial value)	Motor runs at the frequency used before the communication error.			

Pr. 125, 126, Pr. 241, C2(902) to C7(905), C22(922) to C25(923)

Analog input frequency change and adjustment (calibration)

- Pr.125 Terminal 2 frequency setting gain frequency
- Pr.126 Terminal 4 frequency setting gain frequency
- Pr.241 Analog input display unit switchover
- C2(Pr.902) Terminal 2 frequency setting bias frequency
- C3(Pr.902) Terminal 2 frequency setting bias C4(Pr.903) Terminal 2 frequency setting gain
- C5(Pr.904) Terminal 4 frequency setting bias frequency
- C6(Pr.904) Terminal 4 frequency setting bias C7(Pr.905) Terminal 4 frequency setting gain
- C22(Pr.922) Frequency setting voltage bias frequency (built-in potentiometer)
- C23(Pr.922) Frequency setting voltage bias (built-in potentiometer)
- C24(Pr.923) Frequency setting voltage gain frequency (built-in potentiometer)
- C25(Pr.923) Frequency setting voltage gain (built-in potentiometer)

You can set the magnitude (slope) of the output frequency as desired in relation to the frequency setting signal (0 to 5VDC, 0 to 10V or 4 to 20mA).

The C22(Pr.922) to C25(Pr.923) settings can be used when the operation panel (PA02) of FR-E500 series is connected using a cable. The built-in potentiometer of the operation panel can be calibrated.

(1) Change the frequency at maximum analog input. (Pr.125, Pr.126)

Set a value in Pr. 125 (Pr. 126) when changing only the frequency setting (gain) of the maximum analog input power (current). (Other calibration parameter settings can be used without any change.)

(2) Analog input bias/gain calibration (C2(Pr.902) to C7(Pr.905))

The "bias" and "gain" functions are used to adjust the relationship between the input signal entered from outside the inverter to set the output frequency, e.g. 0 to 5V, 0 to 10V or 4 to 20mADC, and the output frequency.

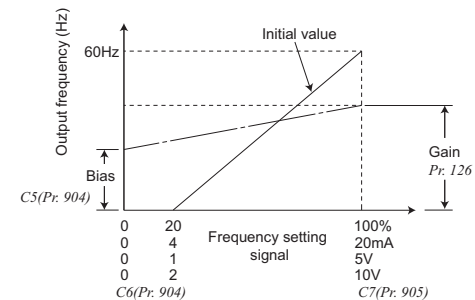
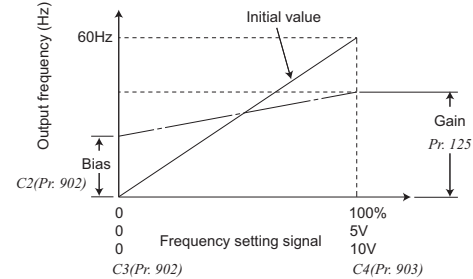

(3) Analog input display unit changing (Pr.241)

You can change the analog input display unit (%V/mA) for analog input bias/gain calibration.

Pr. 127 to 134, 553, 554, 575 to 577, C42(934) to C45(935)
PID control

- Pr.127 PID control automatic switchover frequency
- Pr.128 PID action selection
- Pr.130 PID integral time
- Pr.132 PID lower limit
- Pr.134 PID differential time
- Pr.554 PID signal operation selection
- Pr.576 Output interruption detection level
- C42(Pr.934) PID display bias coefficient
- C44(Pr.935) PID display gain coefficient
- Pr.129 PID proportional band
- Pr.131 PID upper limit
- Pr.133 PID action set point
- Pr.553 PID deviation limit
- Pr.575 Output interruption detection time
- Pr.577 Output interruption cancel level
- C43(Pr.934) PID display bias analog value
- C45(Pr.935) PID display gain analog value

• The inverter can be used to exercise process control, e.g. flow rate, air volume or pressure.
 The terminal 2 input signal or parameter setting is used as a set point and the terminal 4 input signal used as a feedback value to constitute a feedback system for PID control.

• Pr.128 = "20, 21" (Measured value input)

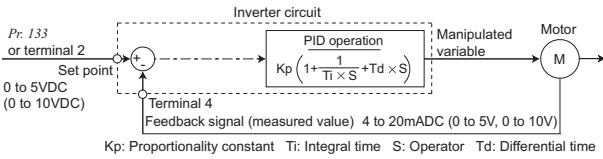

Pr. 145
Parameter unit display language selection

Pr.145 PU display language selection

The display language of the parameter unit (FR-PU04/FR-PU07) can be changed.

Pr.145 setting	Description
0 (initial value)	Japanese
1	English
2	German
3	French
4	Spanish
5	Italian
6	Swedish
7	Finnish

Pr. 146
Built-in potentiometer switching

Pr.146 Built-in potentiometer switching

When using an FR-E500 series operation panel (PA02), the frequency setting method can be switched using Pr.146 Built-in potentiometer switching.

Pr.146 setting	Description
0	Built-in frequency setting potentiometer
1 (initial value)	Digital frequency setting with the "UP/DOWN" key
9999	The frequency setting with the built-in frequency setting potentiometer is enabled when the frequency setting with the "UP/DOWN" key is "0 Hz".

Pr. 150 to 153, 166, 167
Detection of output current (Y12 signal)
detection of zero current (Y13 signal)

- Pr.150 Output current detection level
- Pr.151 Output current detection signal delay time
- Pr.152 Zero current detection level
- Pr.153 Zero current detection time
- Pr.166 Output current detection signal retention time
- Pr.167 Output current detection operation selection

The output current during inverter running can be detected and output to the output terminal.

(1) Output current detection (Y12 signal, Pr. 150, Pr. 151, Pr. 166, Pr. 167)

- The output current detection function can be used for excessive torque detection, etc.
- If the output current remains higher than the Pr.150 setting during inverter operation for longer than the time set in Pr.151, the output current detection signal (Y12) is output from the inverter's open collector or relay output terminal.

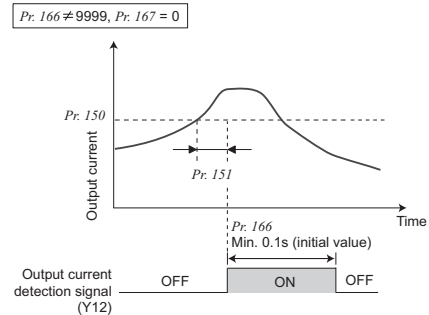

(2) Zero current detection (Y13 signal, Pr. 152, Pr. 153)

- If the output current remains lower than the Pr.152 setting during inverter operation for longer than the time set in Pr.153, the zero current detection (Y13) signal is output from the inverter's open collector or relay output terminal.

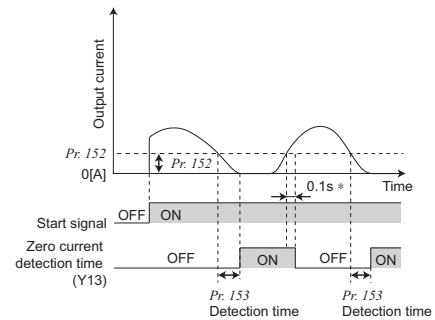

* Once turned ON, the zero current detection time signal (Y13) is held on for at least 0.1s.

Pr. 154, 156, 157 Refer to the section about Pr.22

Pr. 160
Extended parameter display

Pr.160 Extended function display selection

- Parameter which can be read from the operation panel and parameter unit can be restricted.
 In the initial setting, only the simple mode parameters are displayed.

Pr.160 setting	Description
0	Displays all parameters
9999 (initial value)	Displays only the simple mode parameters

Pr. 161, 295

Operation selection of the operation panel

Pr.161 Frequency setting/key lock operation selection
Pr.295 Magnitude of frequency change setting

- You can use the setting dial of the operation panel like a potentiometer to perform operation.
- The key operation of the operation panel can be disabled.

Pr.161 setting	Description	
0 (initial value)	Setting dial frequency setting mode	Key lock mode in valid
1	Setting dial potentiometer mode	
10	Setting dial frequency setting mode	Key lock mode valid
11	Setting dial potentiometer mode	

- When setting a frequency using the setting dial on the operation panel, the frequency change increment is determined by how quickly the setting dial is rotated.

Pr. 162, 165 Refer to the section about Pr.57

Pr. 166, 167 Refer to the section about Pr.150

Pr. 168, 169 Parameter for manufacturer setting. Do not set.

Pr. 170, 171 Refer to the section about Pr.52

Pr. 178 to 182

Function assignment of input terminal

Pr.178 STF terminal function selection *Pr.179 STR terminal function selection*
Pr.180 AU terminal function selection *Pr.181 RM terminal function selection*
Pr.182 RH terminal function selection

Use these parameters to select/change the input terminal functions.

Pr.178 to Pr.182 setting	Signal Name	Function	
0	RL	Pr.59 =0 (initial value)	Low-speed operation command
		Pr.59 ≠ 0 *1	Remote setting (setting clear)
1	RM	Pr.59 =0 (initial value)	Middle-speed operation command
		Pr.59 ≠ 0 *1	Remote setting (deceleration)
2	RH	Pr.59 =0 (initial value)	High-speed operation command
		Pr.59 ≠ 0 *1	Remote setting (acceleration)
3	RT	Second function selection	
4	AU	Terminal 4 input selection	
5	JOG	Jog operation selection	
7	OH	External thermal relay input *2	
8	REX	15-speed selection (combination with three speeds RL, RM, RH)	
10	X10	Inverter run enable signal (FR-HC2, FR-CV connection)	
12	X12	PU operation external interlock	
14	X14	PID control valid terminal	
16	X16	PU/External operation switchover (turning ON X16 selects External operation)	
24	MRS	Output stop	
25	STOP	Start self-holding selection	
60	STF	Forward rotation command (assigned to STF terminal (Pr. 178) only)	
61	STR	Reverse rotation command (assigned to STR terminal (Pr. 179) only)	
62	RES	Inverter reset	
64	X64	Starting frequency for elevator mode	
65	X65	PU/NET operation switchover	
66	X66	External/NET operation switchover	
67	X67	Command source switchover	
72	X72	PWM frequency selection	
9999	—	No function	

*1 When Pr. 59 Remote function selection ≠ "0", the functions of the RL, RM and RH signals are changed as given in the table.
 *2 The OH signal turns ON when the relay contact "opens".

Pr. 190, 192

Terminal assignment of output terminal

Pr.190 RUN terminal function selection Pr.192 A,B,C terminal function selection

You can change the functions of the open collector output terminal and relay output terminal.

Pr.190, Pr.192 setting		Signal Name	Function
Positive logic	Negative logic		
0	100	RUN	Inverter running
1	101	SU	Up to frequency
3	103	OL	Overload alarm
4	104	FU	Output frequency detection
7	107	RBP	Regenerative brake prealarm
8	108	THP	Electronic thermal relay function prealarm
11	111	RY	Inverter operation ready
12	112	Y12	Output current detection
13	113	Y13	Zero current detection
14	114	FDN	PID lower limit
15	115	FUP	PID upper limit
16	116	RL	PID forward/reverse rotation output
25	125	FAN	Fan fault output
26	126	FIN	Heatsink overheat pre-alarm
46	146	Y46	During deceleration at occurrence of power failure (retained until release)
47	147	PID	During PID control activated
48	148	Y48	PID deviation limit
57	157	IPM	IPM motor control *
64	164	Y64	During retry
70	170	SLEEP	During PID output suspension
79	179	Y79	Pulse train output of output power
90	190	Y90	Life alarm
91	191	Y91	Alarm output 3 (power-off signal)
92	192	Y92	Energy saving average value updated timing
93	193	Y93	Current average monitor signal
95	195	Y95	Maintenance timer signal
96	196	REM	Remote output
98	198	LF	Minor fault output
99	199	ALM	Alarm output
9999		—	No function

* This function is available only under IPM motor control.

- Pr. 232 to 239** Refer to the section about Pr.4
- Pr. 240** Refer to the section about Pr.72
- Pr. 241** Refer to the section about Pr.125

Pr. 244

Increase cooling fan life

Pr.244 Cooling fan operation selection

You can control the operation of the cooling fan (1.5K or higher) built in the inverter.

Pr.244 setting	Description
0	The cooling fan operates at power on. Cooling fan on/off control invalid (The cooling fan is always on at power on)
1 (initial value)	Cooling fan on/off control valid. The fan is normally on during inverter operation. The fan switches on/off according to the temperature during a stop of the inverter whose status is monitored.

Pr. 245 to 247

Slip compensation

*Pr.245 Rated slip Pr.246 Slip compensation time constant
Pr.247 Constant-power range slip compensation selection*

The inverter output current may be used to assume motor slip to keep the motor speed constant.

This function is also enabled under V/F control.

Pr. 249

Earth (ground) fault detection at start

Pr.249 Earth (ground) fault detection at start

You can choose whether to make earth (ground) fault detection at start valid or invalid. Earth (Ground) fault detection is executed only right after the start signal is input to the inverter.

Pr.249 setting	Description
0 (initial value)	Without earth (ground) fault detection
1	With earth (ground) fault detection *

- * As detection is executed at start, output is delayed for approx. 20ms every start.
- If an earth (ground) fault is detected with "1" set in Pr. 249, output side earth (ground) fault overcurrent (E.GF) is detected and the inverter trips.
- Protective function will not activate if an earth (ground) fault occurs during operation.
- If the motor capacity is smaller than the inverter capacity when using the 5.5K or higher, earth (ground) fault detection may not be provided.

- Features
- Connection example
- Standard specs.
- Outline dimensions
- Terminal connection diagrams
- Terminal specs.
- Operation panel Parameter unit FR Configurator
- Parameter list
- Parameter descriptions
- Protective functions
- Options
- Precautions
- Motor
- IPM motor control
- Compatibility
- Warranty

Pr. 250 Selection of motor stopping method and start signal

Pr.250 Stop selection

Used to select the stopping method (deceleration to a stop or coasting) when the start signal turns off.

Used to stop the motor with a mechanical brake, etc. together with switching off of the start signal.

You can also select the operations of the start signals (STF/STR).

Pr.250 setting	Description	
	Start signal (STF/STR)	Stop operation
0 to 100s	STF signal: Forward rotation start STR signal: Reverse rotation start	The motor is coasted to a stop when the preset time elapses after the start signal is turned off.
1000s to 1100s	STF signal: Start signal STR signal: Forward/reverse rotation signal	The motor is coasted to a stop (<i>Pr. 250</i> - 1000)s after the start signal is turned off.
9999 (initial value)	STF signal: Forward rotation start STR signal: Reverse rotation start	When the start signal is turned off, the motor decelerates to stop.
8888	STF signal: Start signal STR signal: Forward/reverse rotation signal	

When *Pr. 250* is set to "9999" (initial value) or "8888".

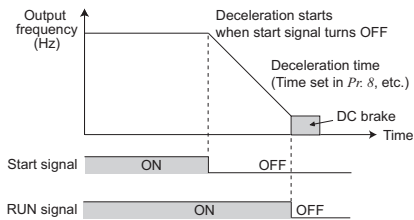

When *Pr. 250* is set to values other than "9999" (initial value) or "8888".

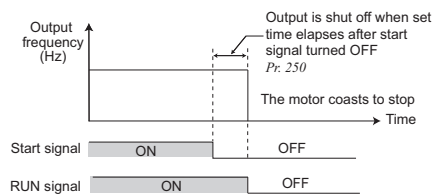

Pr. 251, 872 Input/output phase failure protection selection

Pr.251 Output phase loss protection selection

Pr.872 Input phase loss protection selection

You can disable the output phase failure protection function that stops the inverter output if one of the inverter output side (load side) three phases (U, V, W) opens.

The input phase failure protection selection of the inverter input side (R, S, T) can be made valid.

Pr. Number	Setting Range	Description
251	0	Without output phase failure protection
	1 (initial value)	With output phase failure protection
872	0 (initial value)	Without input phase failure protection
	1	With input phase failure protection

Pr. 255 to 259 Display of the life of the inverter parts

Pr.255 Life alarm status display

Pr.256 Inrush current limit circuit life display

Pr.257 Control circuit capacitor life display

Pr.258 Main circuit capacitor life display

Pr.259 Main circuit capacitor life measuring

Degrees of deterioration of main circuit capacitor, control circuit capacitor or inrush current limit circuit and cooling fan can be diagnosed by monitor.

When any part has approached the end of its life, an alarm can be output by self diagnosis to prevent a fault.

(Use the life check of this function as a guideline since the life except the main circuit capacitor is calculated theoretically.)

Pr. Number	Setting Range	Description
255	(0 to 15)	Display whether the control circuit capacitor, main circuit capacitor, cooling fan, and each parts of the inrush current limit circuit has reached the life alarm output level or not. (Reading only)
256	(0 to 100%)	Display the deterioration degree of the inrush current limit circuit. (Reading only)
257	(0 to 100%)	Display the deterioration degree of the control circuit capacitor. (Reading only)
258	(0 to 100%)	Display the deterioration degree of the main circuit capacitor. (Reading only) The value measured by <i>Pr. 259</i> is displayed.
259	0, 1	Setting "1" and turning off the power starts the measurement of the main circuit capacitor life. When the <i>Pr. 259</i> value is "3" after powering ON again, the measuring is completed. Write the deterioration degree in <i>Pr. 258</i> .

Pr. 260 Refer to the section about *Pr.72*

Pr. 261
Operation at instantaneous power failure V/F GPMFVC

Pr.261 Power failure stop selection

When a power failure or undervoltage occurs, the inverter can be decelerated to a stop or can be decelerated and re-accelerated to the set frequency.

Pr. Number	Setting Range	Description
261	0 (initial value)	Coasts to stop. When undervoltage or power failure occurs, the inverter output is shut off.
	1	When undervoltage or a power failure occurs, the inverter can be decelerated to a stop.
	2	When undervoltage or a power failure occurs, the inverter can be decelerated to a stop. If power is restored during a power failure, the inverter accelerates again.

(1) Power failure stop function (Pr.261 = "1")

- If power is restored during power failure deceleration, deceleration to a stop is continued and the motor remains stopped. To restart, turn OFF the start signal once, then turn it ON again.

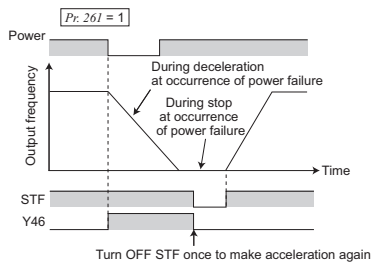

(2) Operation continuation at instantaneous power failure function (Pr.261 = "2")

- When power is restored during deceleration after a power failure, acceleration is made again up to the set frequency.

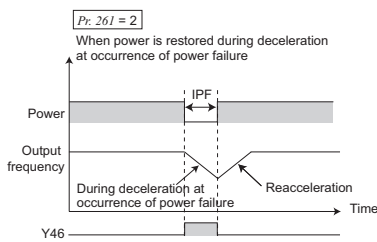

Pr. 267 Refer to the section about Pr.73

Pr. 268 Refer to the section about Pr.52

Pr. 269 Parameter for manufacturer setting. Do not set.

Pr. 295 Refer to the section about Pr.161

Pr. 296, 297
Password function

Pr.296 Password lock level

Pr.297 Password lock/unlock

Registering a 4-digit password can restrict parameter reading/writing.

- Level of reading/writing restriction by PU/NET mode operation command can be selected by Pr. 296.

Pr.296 Setting	PU Mode Operation Command		NET Mode Operation Command		Description
	Read	Write	Read	Write	
9999 (initial value)	○	○	○	○	No password lock
1, 101	○	×	○	×	Select restriction level of parameter reading/writing when a password is registered.
2, 102	○	×	○	○	
3, 103	○	○	○	×	
4, 104	×	×	×	×	
5, 105	×	×	○	○	
6, 106	○	○	×	×	

○: enabled, ×: restricted

Pr. Number	Setting Range	Description
297*	1000 to 9998	Register a 4-digit password
	(0 to 5)	Displays password unlock error count. (Reading only) (Valid when Pr. 296 = "101" to "106")
	(9999) (initial value)	No password lock (Reading only)

* If the password has been forgotten, perform all parameter clear to unlock the parameter restriction. In that case, other parameters are also cleared.

Pr. 298 Refer to the section about Pr.82

Pr. 299 Refer to the section about Pr.57

Pr. 338, 339, 551

Operation command source and speed command source during communication operation

Pr.338 Communication operation command source
Pr.339 Communication speed command source
Pr.551 PU mode operation command source selection

When the RS-485 communication with the PU connector is used, the external start command and frequency command can be valid. Command source in the PU operation mode can be selected.

Pr. Number	Setting Range	Description
338	0 (initial value)	Start command source communication
	1	Start command source external
339	0 (initial value)	Frequency command source communication
	1	Frequency command source external
	2	Frequency command source external (Frequency command from communication is valid, frequency command from terminal 2 is invalid)
551*	2	PU connector is the command source when PU operation mode.
	4	Operation panel is the command source when PU operation mode.
	9999 (initial value)	Parameter unit automatic recognition. Normally, operation panel is the command source. When the parameter unit is connected to the PU connector, PU is the command source.

* Pr. 551 is always write-enabled.

Pr. 340 Refer to the section about Pr.79

Pr. 342, 343 Refer to the section about Pr.117

Pr. 450 Refer to the section about Pr.71

Pr. 374

Overspeed detection IPM

Pr.374 Overspeed detection level

Inverter outputs are stopped when the motor speed exceeds the Pr.374 Overspeed detection level under IPM motor control.

Pr.374 Setting	Description
0 to 400Hz	When the motor speed exceeds the speed set in Pr.374, overspeed (E.OS) occurs, and the inverter outputs are stopped.
9999 (initial value)	No function

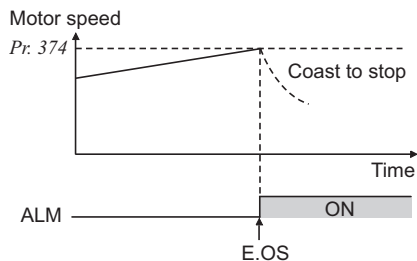

Pr. 495, 496

Remote output function (REM signal)

Pr.495 Remote output selection *Pr.496 Remote output data 1*

You can utilize the ON/OFF of the inverter's output signals instead of the remote output terminal of the programmable controller.

Pr. Number	Setting Range	Description	
495	0 (initial value)	Remote output data clear at powering OFF	Remote output data is cleared during an inverter reset
	1	Remote output data retention even at powering OFF	
	10	Remote output data clear at powering OFF	Remote output data is retained during an inverter reset
	11	Remote output data retention even at powering OFF	
496*	0 to 4095	Refer to the following diagram.	

* This parameter allows its setting to be changed during operation in any operation mode even if "0" (initial value) is set in Pr. 77 Parameter write selection.

<Remote output data>

Pr.496

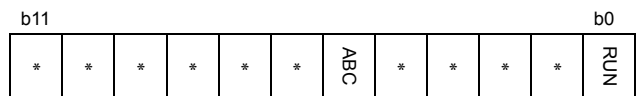

* As desired (Always "0" during reading)

Pr. 502 Refer to the section about Pr.117

Pr. 503, 504

Part maintenance

Pr.503 Maintenance timer

Pr.504 Maintenance timer alarm output set time

When the cumulative energization time of the inverter reaches the parameter set time, the maintenance timer output signal (Y95) is output. MT (MT) is displayed on the operation panel.

This can be used as a guideline for the maintenance time of peripheral devices.

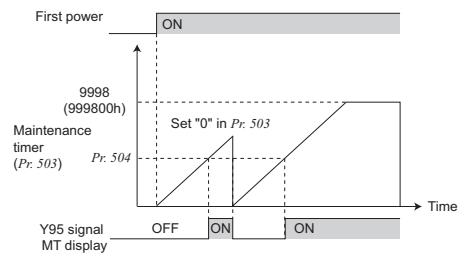

● The cumulative energization time of the inverter is stored into the EEPROM every hour and indicated in Pr. 503 Maintenance timer in 100h increments. Pr. 503 is clamped at 9998 (999800h)

Pr. 549 Refer to the section about Pr.117

Pr. 551 Refer to the section about Pr.338

Pr. 553, 554 Refer to the section about Pr.127

Pr. 555 to 557
Current average value monitor signal

Pr.555 Current average time *Pr.556 Data output mask time*
Pr.557 Current average value monitor signal output reference current

The average value of the output current during constant speed operation and the maintenance timer value are output as a pulse to the current average value monitor signal (Y93).

The pulse width output to the I/O module of the PLC or the like can be used as a guideline due to abrasion of machines and elongation of belt and for aged deterioration of devices to know the maintenance time.

The current average value monitor signal (Y93) is output as pulse for 20s as 1 cycle and repeatedly output during constant speed operation.

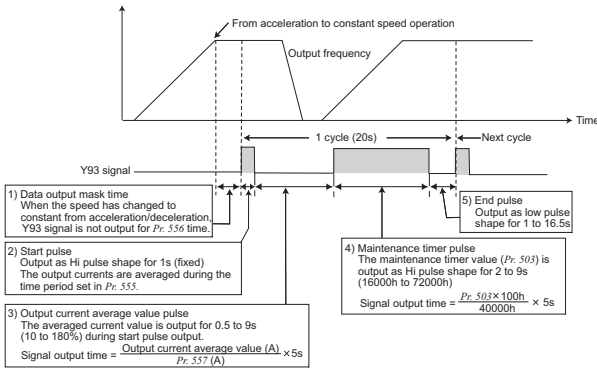

- Pr. 561** Refer to the section about Pr:9
- Pr. 563, 564** Refer to the section about Pr:52
- Pr. 571** Refer to the section about Pr:13
- Pr. 575 to 577** Refer to the section about Pr:127
- Pr. 611** Refer to the section about Pr:57

Pr. 653
Machine resonance suppression

V/F **GP MFVC**

Pr.653 Speed smoothing control

The vibration (resonance) of the machine during motor operation can be suppressed.

Set "100%" in Pr.653 and check the vibration. Lower the setting gradually and adjust to the point where the vibration is minimum.

Pr. 665, 882, 883, 885, 886
Regeneration avoidance function

Pr.665 Regeneration avoidance frequency gain
Pr.882 Regeneration avoidance operation selection
Pr.883 Regeneration avoidance operation level
Pr.885 Regeneration avoidance compensation frequency limit value
Pr.886 Regeneration avoidance voltage gain

This function detects a regeneration status and increases the frequency to avoid the regeneration status.

- Possible to avoid regeneration by automatically increasing the frequency and continue operation if the fan happens to rotate faster than the set speed due to the effect of another fan in the same duct.

Pr. Number	Setting Range	Description
882	0 (initial value)	Regeneration avoidance function invalid
	1	Regeneration avoidance function valid
	2	Regeneration avoidance function valid only during constant-speed operation
883	300 to 800V	Set the bus voltage level at which regeneration avoidance operates. When the bus voltage level is set to low, overvoltage error will be less apt to occur. However, the actual deceleration time increases. The set value must be higher than the power supply voltage $\times \sqrt{2}$.
	0 to 30Hz	Set the limit value of frequency which rises at activation of regeneration avoidance function.
885	9999	Frequency limit invalid
	0 to 200%	Adjust responsiveness at activation of regeneration avoidance. A larger setting will improve responsiveness to the bus voltage change. However, the output frequency could become unstable. When vibration is not suppressed by decreasing the Pr. 886 setting, set a smaller value in Pr. 665.
665		

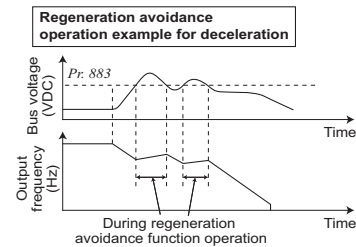

- Pr. 779** Refer to the section about Pr:117
- Pr. 791, 792** Refer to the section about Pr:7

Pr. 799
Pulse train output of output power (Y79 signal)

Pr.799 Pulse increment setting for output power

After power ON or inverter reset, output signal (Y79 signal) is output in pulses every time accumulated output power, which is counted after the *Pr.799 Pulse increment setting for output power* is set, reaches the specified value (or its integral multiples).

Pr.799 setting	Description
0.1kWh, 1kWh (initial value) 10kWh, 100kWh, 1000kWh	Pulse train output of output power (Y79) is output in pulses at every output power (kWh) that is specified.

- The inverter continues to count the output power at retry function or when automatic restart after instantaneous power failure function works without power OFF of output power (power failure that is too short to cause an inverter reset), and it does not reset the count.
- If power failure occurs, output power is counted from 0kWh again.
- Assign pulse output of output power (Y79: setting value 79 (positive logic), 179 (negative logic)) to any of *Pr.190*, *Pr.192* (*Output terminal function selection*).

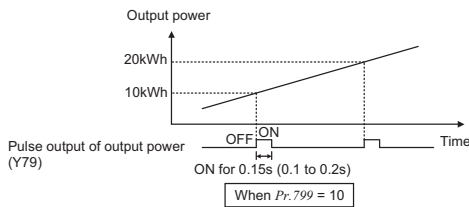

Pr. 800
IPM motor test operation IPM

Pr.800 Control method selection

Without connecting an IPM motor, the frequency movement can be checked by the monitor or analog signal output. Two types of operation can be selected using this parameter: an actual operation by connecting an IPM motor, or a test operation without connecting an IPM motor to simulate a virtual operation.

Pr.800 setting	Description
9	IPM motor test operation (Motor is not driven even if it is connected.)
30 (initial value)	Normal operation (Motor can be driven.)

Pr. 820, 821
Speed loop gain P gain, integral time adjustment IPM

Pr.820 Speed control P gain 1 *Pr.821 Speed control integral time 1*

Manual adjustment of gain is useful to exhibit the optimum performance of the machine or to improve unfavorable conditions such as vibration and acoustic noise during the operation with high load inertia or gear backlashes.

- Speed control P gain (*Pr.820*)
 The proportional gain during speed control is set. Setting this parameter higher improves the trackability for speed command changes. It also reduces the speed fluctuation due to a load fluctuation.
- Speed control integral time (*Pr.821*)
 The integral time during speed control is set. Setting this parameter lower shortens the return time to the original speed when the speed fluctuates due to a load fluctuation.

Pr. 870 Refer to the section about *Pr.41*

Pr. 872 Refer to the section about *Pr.251*

Pr. 882, 883, 885, 886 Refer to the section about *Pr.665*

Pr. 888, 889
Free parameter

Pr.888 Free parameter 1 *Pr.889 Free parameter 2*

Parameters you can use for your own purposes.

You can input any number within the setting range 0 to 9999.

For example, the number can be used:

- As a unit number when multiple units are used.
- As a pattern number for each operation application when multiple units are used.
- As the year and month of introduction or inspection.

Pr. 891 Refer to the section about *Pr.52*

Pr. 892 to 899
Energy saving monitor

- Pr.892 Load factor
- Pr.893 Energy saving monitor reference (motor capacity)
- Pr.894 Control selection during commercial power-supply operation
- Pr.895 Power saving rate reference value Pr.896 Power unit cost
- Pr.897 Power saving monitor average time
- Pr.898 Power saving cumulative monitor clear
- Pr.899 Operation time rate (estimated value)

From the power consumption estimated value during commercial power supply operation, the energy saving effect by use of the inverter can be monitored/output.

- The following provides the items that can be monitored by the power saving monitor (Pr. 52, Pr. 54 = "50").
 (Only power saving and average power saving value can be output to Pr. 54 (terminal FM))

Energy Saving Monitor Item	Description and Formula	Increments
Power saving	Difference between the estimated value of power necessary for commercial power supply operation and the input power calculated by the inverter Power during commercial power supply operation - input power monitor	0.01kW
Power saving rate	Ratio of power saving on the assumption that power during commercial power supply operation is 100% $\frac{\text{Power saving}}{\text{Power during commercial power supply operation}} \times 100$	0.1%
	Ratio of power saving on the assumption that Pr. 893 is 100% $\frac{\text{Power saving}}{\text{Pr.893}} \times 100$	
Power saving average value	Average value of power saving amount per hour during predetermined time (Pr. 897) $\frac{\sum (\text{Power saving} \times \Delta t)}{\text{Pr.897}}$	0.01kWh
Power saving rate average value	Ratio of average power saving value on the assumption that the value during commercial power supply operation is 100% $\frac{\sum (\text{Power saving rate} \times \Delta t)}{\text{Pr.897}} \times 100$	0.1%
	Ratio of average power saving value on the assumption that Pr. 893 is 100% $\frac{\text{Power saving average value}}{\text{Pr.893}} \times 100$	
Power saving charge average value	Power saving average value represented in terms of charge Power saving average value × Pr.896	0.01

- The following gives the items which can be monitored by the cumulative power saving monitor (Pr. 52 = "51").
 (The cumulative power monitor data digit can be shifted to the right by the number set in Pr. 891 Cumulative power monitor digit shifted times.)

Energy Saving Monitor Item	Description and Formula	Increments
Power saving amount	Power saving is added up per hour. $\sum (\text{Power saving} \times \Delta t)$	0.01kWh
Power cost savings	Power saving amount represented in terms of charge Power saving amount × Pr.896	0.01
Annual power saving amount	Estimated value of annual power saving amount $\frac{\text{Power saving amount}}{\text{Operation time during power saving totalization}} \times 24 \times 365 \times \frac{\text{Pr.899}}{100}$	0.01kWh
Annual power cost savings	Annual power saving amount represented in terms of charge Annual power saving amount × Pr.896	0.01

Pr. C0(900)
Adjustment of terminal FM (calibration)

C0(Pr.900) FM terminal calibration

The operation panel and parameter unit can be used to calibrate the full scales of the terminals FM.

FM terminal calibration (C0(Pr.900))

- The terminal FM is preset to output pulses. By setting the Calibration parameter C0 (Pr. 900), the meter connected to the inverter can be calibrated by parameter setting without use of a calibration resistor.
- Using the pulse train output of the terminal FM, a digital display can be provided by a digital counter. The monitor value is 1440 pulses/s output at the full-scale value of Pr. 54 FM terminal function selection.

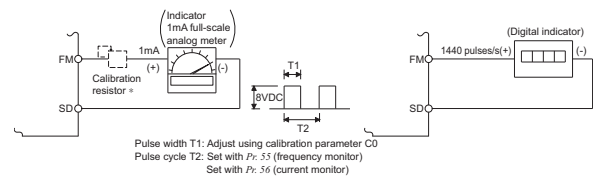

- * Not needed when the operation panel or parameter unit (FR-PU04/FR-PU07) is used for calibration. Use a calibration resistor when the indicator (frequency meter) needs to be calibrated by a neighboring device because the indicator is located far from the inverter. However, the frequency meter needle may not deflect to full-scale if the calibration resistor is connected. In this case, perform calibration using the operation panel or parameter unit.

Pr. C2(902) to C7(905), C22(922) to C25(923) Refer to the section about Pr.125

Pr. C42(934) to C45(935) Refer to the section about Pr.127

Pr. 990
Buzzer control of the operation panel

Pr.990 PU buzzer control

You can make the buzzer "beep" when you press key of the parameter unit (FR-PU04/FR-PU07).

Pr.990 setting	Description
0	Without buzzer
1 (initial value)	With buzzer

Features
 Connection example
 Standard specs.
 Outline dimensions
 Terminal connection diagrams
 Terminal specs.
 Operation panel
 Parameter unit
 FR Configurator
 Parameter list
 Parameter descriptions
 Protective functions
 Options
 Precautions
 Motor
 IPM motor control
 Compatibility
 Warranty

Pr. 991

PU contrast adjustment

Pr.991 PU contrast adjustment

Contrast adjustment of the LCD of the parameter unit (FR-PU04/FR-PU07) can be performed.

Decreasing the setting value makes the contrast lighter.

Pr.991 setting	Description
0 to 63	0 : Light ↓ 63 : Dark

Pr. 997

Initiating a fault

Pr.997 Fault initiation

A fault is initiated by setting the parameter.

This function is useful to check how the system operates at a fault.

The read value is always "9999." Setting "9999" does not initiate a fault.

- Setting for *Pr.997 Fault initiation* and corresponding faults

Pr.997 setting	Fault	Pr.997 setting	Fault	Pr.997 setting	Fault
16	E.OC1	82	E.ILF	178	E.RET
17	E.OC2	96	E.OLT	192	E.CPU
18	E.OC3	97	E.SOT	196	E.CDO
32	E.OV1	112	E.BE	197	E.IOH
33	E.OV2	128	E.GF	199	E.AIE
34	E.OV3	129	E.IF	201	E.SAF
48	E.THT	144	E.OHT	208	E.OS
49	E.THM	145	E.PTC	230	E.PID
64	E.FIN	176	E.PE	245	E.5
81	E.UVT	177	E.PUE		

Pr. 998, IPM

Refer to page 77

Pr. 999, AUTO

Automatic parameter setting

Pr.999 Automatic parameter setting *AUTO Automatic parameter setting*

Parameter settings are changed as a batch. Those include communication parameter settings for the Mitsubishi human machine interface (GOT) connection, rated frequency settings of 50Hz/60Hz.

Multiple parameters are changed automatically. Users do not have to consider each parameter number. (Parameter setting mode)

Pr.999 setting	Description	Operation in the parameter setting mode (AUTO)
9999 (initial value)*	No action	—
10	Automatically sets the communication parameters for the GOT connection with a PU connector	"AUTO" → "GOT" → Write "1"
20	50Hz rated frequency	Sets the related parameters of the rated frequency according to the power supply frequency "AUTO" → "F50" → Write "1"
21	60Hz rated frequency	

* The read value is always "9999".

Pr. CL, ALLC, Er.CL, CH

Parameter clear, Initial value change list

Pr.CL Parameter clear

ALLC All parameter clear

Er.CL Fault history clear

Pr.CH Initial value change list

- Set "1" in *Pr.CL Parameter clear* to initialize all parameters. (Calibration parameters are not cleared.) *
- Set "1" in *ALLC All parameter clear* to initialize all parameters. *
- Set "1" in *Er.CL Fault history clear* to clear alarm history.
- Using *Pr.CH Initial value change list*, only the parameters changed from the initial value can be displayed.

* Parameters are not cleared when "1" is set in *Pr.77 Parameter write selection*.

When an alarm occurs in the inverter, the protective function is activated bringing the inverter to an alarm stop and the PU display automatically changes to any of the following error (alarm) indications.

	Function Name	Description	Indication
Error message *2	Operation panel lock	Appears when operation is tried during operation panel lock.	HOLD
	Password locked	Appears when a password restricted parameter is read/written.	LOCK
	Parameter write error	Appears when an error occurs at parameter writing.	Er 1 to Er 4
	Inverter reset	Appears when the RES signal is ON during the inverter reset.	Err.
Warnings *3	Stall prevention (overcurrent)	Appears during overcurrent stall prevention.	OL
	Stall prevention (overvoltage)	Appears during overvoltage stall prevention. Appears while the regeneration avoidance function is activated.	oL
	Regenerative brake pre-alarm *7	Appears if the regenerative brake duty reaches or exceeds 85% of the Pr. 70 "Special regenerative brake duty" value. If the regenerative brake duty reaches 100%, a regenerative overvoltage (E. OV_) occurs.	rb
	Electronic thermal relay function pre-alarm	Appears when the electronic thermal O/L relay has reached 85% of the specified value.	rH
	PU stop	Appears when on the operation panel was pressed during External operation.	PS
	Maintenance signal output *7	Appears when the cumulative energization time has exceeded the maintenance output timer set value.	nr
	Undervoltage	Appears when the voltage at the main circuit power supply is low.	Uu
	SA	Appears when the shorting wire across the terminals S1 and SC or the terminals S2 and SC is disconnected.	SR
Alarm *4	Fan alarm	Appears when the cooling fan remains stopped when operation is required or when the speed has decreased.	Fn
Fault *5	Overcurrent trip during acceleration	Appears when an overcurrent occurred during acceleration.	E0C1
	Overcurrent trip during constant speed	Appears when an overcurrent occurred during constant speed operation.	E0C2
	Overcurrent trip during deceleration or stop	Appears when an overcurrent occurred during deceleration and at a stop.	E0C3
	Regenerative overvoltage trip during acceleration	Appears when an overvoltage occurred during acceleration.	E0v1
	Regenerative overvoltage trip during constant speed	Appears when an overvoltage occurred during constant speed operation.	E0v2
	Regenerative overvoltage trip during deceleration or stop	Appears when an overvoltage occurred during deceleration and at a stop.	E0v3
	Inverter overload trip (electronic thermal relay function)	Appears when the electronic thermal relay function for inverter element protection was activated.	EfHr
	Motor overload trip (electronic thermal relay function) *1	Appears when the electronic thermal relay function for motor protection was activated.	EfHn
	Heatsink overheat	Appears when the heatsink overheated.	EfIn
	Undervoltage *9	This function is activated when the restart operation is repeatedly unsuccessful because the power supply voltage of the inverter has dropped.	EUvF
	Input phase loss *7 *8	Appears if one of the three phases on the inverter's input side is lost. It may also appear when the input powers to the three phases are largely unbalanced.	EILF
	Stall prevention stop	Appears when the output frequency drops to 1Hz (1.5Hz under IPM motor control) due to the deceleration with an overloaded motor.	EOLr
	Loss of synchronism detection *9	Appears when the operation is not synchronized.	ESOr
	Brake transistor alarm detection/ internal circuit fault	This function stops the inverter output if an alarm occurs in the brake circuit, e.g. damaged brake transistors. In this case, the inverter must be powered off immediately.	E. bE
	Output side earth (ground) fault overcurrent at start *7	Appears when an earth (ground) fault occurred on the inverter's output side. (Detected only at a start.)	E. GF
Output phase loss	If one of the three phases (U, V, W) on the inverter's output side (load side) is lost during inverter operation (except during DC injection brake operation and when output frequency is under 1Hz), inverter stops the output.	E. LF	

Features

Connection example

Standard specs.

Outline dimensions

Terminal connection diagrams
Terminal specs.

Operation panel
Parameter unit
FR Configurator

Parameter list

Parameter descriptions

Protective functions

Options

Precautions

Motor

IPM motor control

Compatibility

Warranty

Function Name		Description	Indication
Fault #5	External thermal relay operation *6 *7	Appears when the external thermal relay connected to the terminal OH operated.	E.OH Γ
	PTC thermistor operation *7	Appears when the resistance of the PTC thermistor, which is connected across terminals 2 and 10, reaches the <i>Pr.561 PTC thermistor protection level</i> setting or higher.	E.PTC
	Parameter storage device fault	Appears when operation of the element where parameters are stored became abnormal. (control circuit board)	E. PE
	PU disconnection	Appears when a communication error between the PU and inverter occurred, the communication interval exceeded the permissible time during the RS-485 communication with the PU connector, or communication errors exceeded the number of retries during the RS-485 communication.	E.PUE
	Retry count excess *7	Appears when the operation was not restarted within the set number of retries.	E.r.E Γ
	CPU fault	Appears during the CPU and peripheral circuit errors.	E. S/ E.CPU
	Output current detection value exceeded *7	Appears when output current exceeded the output current detection level set by the parameter.	E.CdO
	Inrush current limit circuit fault	Appears when the resistor of the inrush current limit circuit overheated.	E.I OH
	Analog input fault	Appears if voltage (current) is input to terminal 4 when the setting in <i>Pr.267 Terminal 4 input selection</i> and the setting of voltage/current input switch are different.	E.AI E
	Overspeed occurrence *9	Stops the inverter outputs when the motor speed exceeds the <i>Pr. 374 Overspeed detection level</i> under IPM motor control.	E. OS
	PID signal fault	Appears when any of during PID control, PID upper limit (FUP), PID lower limit (FDN), and PID deviation limit (Y48) turns ON during PID control.	E.PI d
	E.SAF	· Appears when an internal circuit error occurred. · Appears when either contact between the terminals S1 and SC or the terminals S2 and SC is open.	E.SAF

- *1 Resetting the inverter initializes the internal accumulated heat value of the electronic thermal relay function.
- *2 The error message shows an operational error. The inverter output is not shut off.
- *3 Warnings are messages given before faults occur. The inverter output is not shut off.
- *4 Alarm warn the operator of failures with output signals. The inverter output is not shut off.
- *5 When faults occur, the protective functions are activated to shut off the inverter output and output the alarms.
- *6 The external thermal operates only when the OH signal is set in *Pr. 178 to Pr. 182* (input terminal function selection).
- *7 This protective function is not available in the initial status.
- *8 This protective function is available when *Pr.872 Input phase loss protection selection* ="1".
- *9 This function is available only under IPM motor control.

List of options

	Name	Model	Applications, Specifications, etc.	Applicable Inverter
Stand-alone type	Parameter unit (Eight languages)	FR-PU07 FR-PU04	Interactive parameter unit with LCD display	Applicable for all models
	Enclosure surface operation panel	FR-PA07	This operation panel enables inverter operation and monitoring of frequency, etc. from the enclosure surface	Applicable for all models
	Parameter unit connection cable	FR-CB20□	Cable for connection of operation panel or parameter unit □ indicates a cable length. (1m, 3m, 5m)	Applicable for all models
	DIN rail attachment	FR-UDA01 to 03	Attachment for installation on DIN rail	Applicable for the 3.7K or lower
	AC reactor	FR-HAL	For harmonic current reduction and inverter input power factor improvement	Applicable for the certain capacities
	DC reactor	FR-HEL		
	EMC Directive compliant EMC filter	SF FR-E5NF	An EMC filter that complies with the EMC Directive (EN61800-3 C3).	Applicable for the certain capacities
	EMC filter installation attachment	FR-A5AT03	An attachment used to mount an EMC compliant EMC filter (SF) to an inverter.	Applicable for the certain capacities
		FR-AAT02		
		FR-E5T		
	Radio noise filter	FR-BIF(H)	For radio noise reduction (connect to the input side)	Applicable for all models
	Line noise filter	FR-BSF01 FR-BLF	For line noise reduction	Applicable for all models
	Filterpack *1	FR-BFP2	A Filterpack that contains a power factor improving DC reactor, common mode choke, and capacitive filter (radio noise filter) in one.	Applicable for the certain capacities
	Brake resistor	MRS type, MYS type	For increasing the regenerative braking capability (permissible duty 3%/6%ED)	200V: Applicable for the certain capacities
	High-duty brake resistor	FR-ABR	For increasing the regenerative braking capability (permissible duty 10%/ 6%ED)	Applicable for the certain capacities
	Brake unit Resistor unit Discharging resistor	FR-BU2 FR-BR GZG, GRZG type	For increasing the braking capability of the inverter (for high-inertia load or negative load) Brake unit, electrical-discharge resistor and resistor unit are used in combination	Applicable for the certain capacities
	Power regeneration common converter Stand-alone reactor dedicated for FR-CV	FR-CV FR-CVL	Unit which can return motor-generated braking energy back to the power supply in common converter system	Applicable for the certain capacities
High power factor converter	FR-HC2	The high power factor converter switches the converter section on/off to reshape an input current waveform into a sine wave, greatly suppressing harmonics. (Used in combination with the standard accessory.)	Applicable for the certain capacities	
Surge voltage suppression filter	FR-ASF-H	Filter for suppressing surge voltage on motor	400V: Applicable for the certain capacities	
	FR-BMF-H		400V: applicable for the 5.5K or higher	
FR Series Manual Controller/ Speed controller	Manual controller	FR-AX	For independent operation. With frequency meter, frequency potentiometer and start switch.	Applicable for all models
	DC tach. follower	FR-AL	For synchronous operation (1VA) by external signal (0 to 5V, 0 to 10V DC) *2	
	Three speed selector	FR-AT	For three speed switching, among high, middle and low speed operation (1.5VA) *2	
	Motorized speed setter	FR-FK	For remote operation. Allows operation to be controlled from several places (5VA) *2	
	Ratio setter	FR-FH	For ratio operation. Allows ratios to be set to five inverters. (3VA) *2	
	PG follower	FR-FP	For tracking operation by a pilot generator (PG) signal (3VA) *2	
	Master controller	FR-FG	Master controller (5VA) for parallel operation of multiple (maximum 35) inverters. *2	
	Soft starter	FR-FC	For soft start and stop. Enables acceleration/deceleration in parallel operation (3VA) *2	
	Deviation detector	FR-FD	For continuous speed control operation. Used in combination with a deviation sensor or synchro (5VA) *2	
	Preamplifier	FR-FA	Used as an A/V converter or arithmetic amplifier (3VA) *2	
Others	Pilot generator	QVAH-10	For tracking operation. 70V/35VAC 500Hz (at 2500r/min)	
	Deviation sensor	YVGC-500W-NS	For continuous speed control operation (mechanical deviation detection). Output 90VAC/90°	
	Frequency setting potentiometer	WA2W 1kΩ	For frequency setting. Wire-wound 2W 1kΩ type B characteristic	
	Frequency meter (64mm×60mm)	YM206NRI 1mA	Dedicated frequency meter (graduated to 120Hz). Moving-coil type DC ammeter	
	Calibration resistor	RV24YN 10kΩ	For frequency meter calibration. Carbon film type B characteristic	
	FR Configurator (Inverter setup software)	FR-SW3- SETUP-WE	Supports an inverter startup to maintenance	

*1 A Filterpack (FR-BFP2) is enclosed with the FR-F700PJ-□KF inverters.

*2 Rated power consumption. The power supply specifications of the FR series manual controllers and speed controllers are 200VAC 50Hz, 220/220VAC 60Hz, and 115VAC 60Hz.

Features

Connection example

Standard specs.

Outline dimensions

Terminal connection diagrams
Terminal specs.

Operation panel
Parameter unit
FR Configurator

Parameter list

Parameter descriptions

Protective functions

Options

Precautions



Motor



IPM motor control

Compatibility

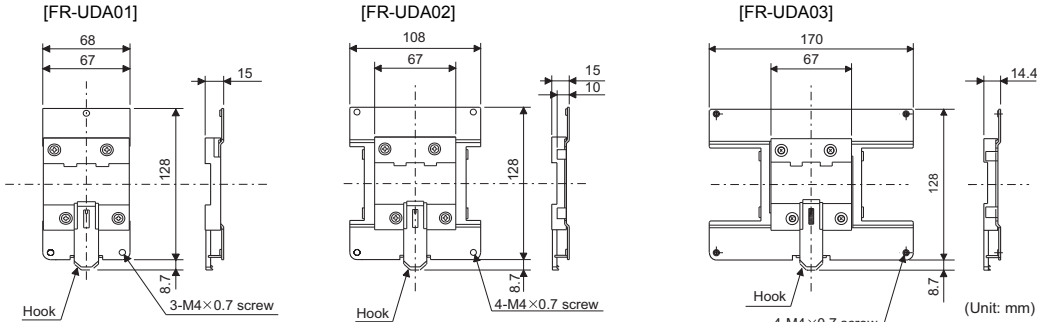

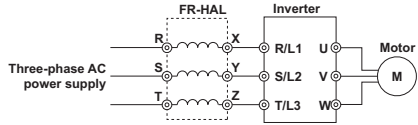
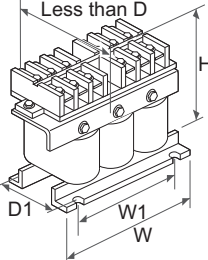
Warranty

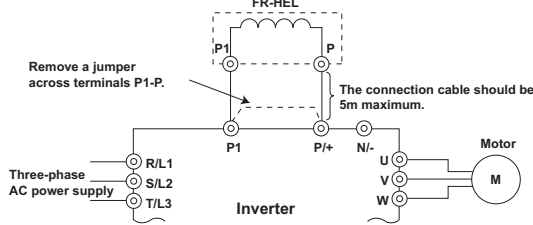
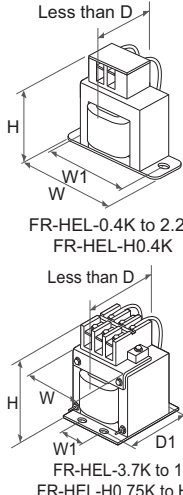
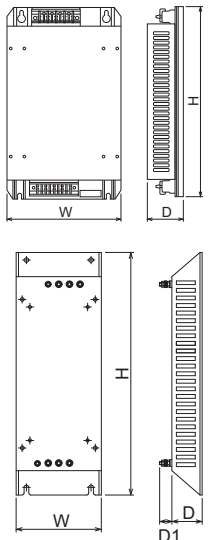
Stand-alone option

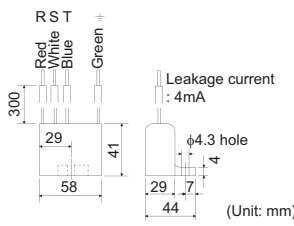
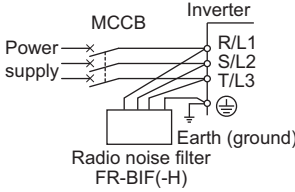
Name (model)	Specification and Structure																																																																																																																																																																																			
<p>Enclosure surface operation panel FR-PA07</p> 	<ul style="list-style-type: none"> An operation panel that enables inverter operation and monitoring of frequency setting, etc. from the enclosure surface. Specification <table border="1" data-bbox="371 315 1083 544"> <thead> <tr> <th>Item</th> <th>Description</th> </tr> </thead> <tbody> <tr> <td>Surrounding air temperature</td> <td>-10°C to +50°C (non-freezing)</td> </tr> <tr> <td>Ambient humidity</td> <td>90%RH or less (non-condensing)</td> </tr> <tr> <td>Storage temperature</td> <td>-20°C to +60°C</td> </tr> <tr> <td>Atmosphere</td> <td>Indoors (free from corrosive gas, flammable gas, oil mist, dust and dirt)</td> </tr> <tr> <td>Maximum altitude/Vibration</td> <td>1,000m or less, 5.9m/s² or less</td> </tr> <tr> <td>Power supply</td> <td>Power input from the inverter</td> </tr> <tr> <td>Connection method</td> <td>Connection using the parameter unit connection cable (FR-CB20□)</td> </tr> </tbody> </table> Outline drawing and enclosure cut dimension drawing (Refer to page 13) <p>(Note) 1. The operation panel cannot be removed from the inverter. 2. The separate parameter unit connection cable (FR-CB20□) is required.</p>	Item	Description	Surrounding air temperature	-10°C to +50°C (non-freezing)	Ambient humidity	90%RH or less (non-condensing)	Storage temperature	-20°C to +60°C	Atmosphere	Indoors (free from corrosive gas, flammable gas, oil mist, dust and dirt)	Maximum altitude/Vibration	1,000m or less, 5.9m/s ² or less	Power supply	Power input from the inverter	Connection method	Connection using the parameter unit connection cable (FR-CB20□)																																																																																																																																																																			
Item	Description																																																																																																																																																																																			
Surrounding air temperature	-10°C to +50°C (non-freezing)																																																																																																																																																																																			
Ambient humidity	90%RH or less (non-condensing)																																																																																																																																																																																			
Storage temperature	-20°C to +60°C																																																																																																																																																																																			
Atmosphere	Indoors (free from corrosive gas, flammable gas, oil mist, dust and dirt)																																																																																																																																																																																			
Maximum altitude/Vibration	1,000m or less, 5.9m/s ² or less																																																																																																																																																																																			
Power supply	Power input from the inverter																																																																																																																																																																																			
Connection method	Connection using the parameter unit connection cable (FR-CB20□)																																																																																																																																																																																			
<p>DIN rail installation attachment FR-UDA□□</p>	<ul style="list-style-type: none"> An attachment to install an FR-F700PJ series inverter to a DIN rail. Selection table <table border="1" data-bbox="371 685 876 792"> <thead> <tr> <th rowspan="2">Installation attachment model</th> <th colspan="2">Inverter capacity</th> </tr> <tr> <th>FR-F720PJ</th> <th>FR-F740PJ</th> </tr> </thead> <tbody> <tr> <td>FR-UDA01</td> <td>0.4K, 0.75K</td> <td>—</td> </tr> <tr> <td>FR-UDA02</td> <td>1.5K, 2.2K</td> <td>0.4K to 3.7K</td> </tr> <tr> <td>FR-UDA03</td> <td>3.7K</td> <td>—</td> </tr> </tbody> </table> Outline dimension drawing  	Installation attachment model	Inverter capacity		FR-F720PJ	FR-F740PJ	FR-UDA01	0.4K, 0.75K	—	FR-UDA02	1.5K, 2.2K	0.4K to 3.7K	FR-UDA03	3.7K	—																																																																																																																																																																					
Installation attachment model	Inverter capacity																																																																																																																																																																																			
	FR-F720PJ	FR-F740PJ																																																																																																																																																																																		
FR-UDA01	0.4K, 0.75K	—																																																																																																																																																																																		
FR-UDA02	1.5K, 2.2K	0.4K to 3.7K																																																																																																																																																																																		
FR-UDA03	3.7K	—																																																																																																																																																																																		
<p>AC reactor (for power supply coordination) FR-HAL-(H)□□K</p> 	<ul style="list-style-type: none"> Improves the power factor and reduces the harmonic current at the input side. Connect an AC reactor at the input side of the inverter. Selection method Select an AC reactor according to the applied motor capacity. (When a general-purpose motor is used, select it according to the motor capacity even if the capacity is smaller than the inverter capacity.) Connection diagram  Outline dimension <table border="1" data-bbox="371 1489 1193 1747"> <thead> <tr> <th colspan="2"></th> <th colspan="14">(Unit mm)</th> </tr> <tr> <th>Model</th> <th>W</th> <th>W1</th> <th>H</th> <th>D</th> <th>D1</th> <th>d</th> <th>Mass (kg)</th> <th>Model</th> <th>W</th> <th>W1</th> <th>H</th> <th>D</th> <th>D1</th> <th>d</th> <th>Mass (kg)</th> </tr> </thead> <tbody> <tr> <td rowspan="6">200V</td> <td>0.4K</td> <td>104</td> <td>84</td> <td>99</td> <td>72</td> <td>40</td> <td>M5</td> <td>0.6</td> <td rowspan="12">400V</td> <td>H0.4K</td> <td>135</td> <td>120</td> <td>115</td> <td>64</td> <td>45</td> <td>M4</td> <td>1.5</td> </tr> <tr> <td>0.75K</td> <td>104</td> <td>84</td> <td>99</td> <td>74</td> <td>44</td> <td>M5</td> <td>0.8</td> <td>H0.75K</td> <td>135</td> <td>120</td> <td>115</td> <td>64</td> <td>45</td> <td>M4</td> <td>1.5</td> </tr> <tr> <td>1.5K</td> <td>104</td> <td>84</td> <td>99</td> <td>77</td> <td>50</td> <td>M5</td> <td>1.1</td> <td>H1.5K</td> <td>135</td> <td>120</td> <td>115</td> <td>64</td> <td>45</td> <td>M4</td> <td>1.5</td> </tr> <tr> <td>2.2K</td> <td>115</td> <td>40</td> <td>115</td> <td>77</td> <td>57</td> <td>M6</td> <td>1.5</td> <td>H2.2K</td> <td>135</td> <td>120</td> <td>115</td> <td>64</td> <td>45</td> <td>M4</td> <td>1.5</td> </tr> <tr> <td>3.7K</td> <td>115</td> <td>40</td> <td>115</td> <td>83</td> <td>67</td> <td>M6</td> <td>2.2</td> <td>H3.7K</td> <td>135</td> <td>120</td> <td>115</td> <td>74</td> <td>57</td> <td>M4</td> <td>2.5</td> </tr> <tr> <td>5.5K</td> <td>115</td> <td>40</td> <td>115</td> <td>83</td> <td>67</td> <td>M6</td> <td>2.3</td> <td>H5.5K</td> <td>160</td> <td>145</td> <td>142</td> <td>76</td> <td>55</td> <td>M4</td> <td>3.5</td> </tr> <tr> <td rowspan="5">400V</td> <td>7.5K</td> <td>130</td> <td>50</td> <td>135</td> <td>100</td> <td>86</td> <td>M6</td> <td>4.2</td> <td>H7.5K</td> <td>160</td> <td>145</td> <td>142</td> <td>96</td> <td>75</td> <td>M4</td> <td>5.0</td> </tr> <tr> <td>11K</td> <td>160</td> <td>75</td> <td>164</td> <td>111</td> <td>92</td> <td>M6</td> <td>5.2</td> <td>H11K</td> <td>160</td> <td>145</td> <td>146</td> <td>96</td> <td>75</td> <td>M4</td> <td>6.0</td> </tr> <tr> <td>15K</td> <td>160</td> <td>75</td> <td>167</td> <td>126</td> <td>107</td> <td>M6</td> <td>7.0</td> <td>H15K</td> <td>220</td> <td>200</td> <td>195</td> <td>105</td> <td>70</td> <td>M5</td> <td>9.0</td> </tr> </tbody> </table>  <p>(Note) 1. Approximately 88% of the power factor improving effect can be obtained (92.3% when calculated with 1 power factor for the fundamental wave according to the Architectural Standard Specifications (Electrical Installation) (2013 revision) supervised by the Ministry of Land, Infrastructure, Transport and Tourism of Japan). 2. This is a sample outline dimension drawing. The shape differs by the model. W1 and D1 indicate distances between installation holes. The installation hole size is indicated by d. 3. Install AC reactors (FR-HAL) on a horizontal or vertical surface. 4. Keep enough clearance around the reactor because it heats up. (Keep a clearance of minimum 10cm each on top and bottom and minimum 5cm each on right and left regardless of the installation orientation.)</p>			(Unit mm)														Model	W	W1	H	D	D1	d	Mass (kg)	Model	W	W1	H	D	D1	d	Mass (kg)	200V	0.4K	104	84	99	72	40	M5	0.6	400V	H0.4K	135	120	115	64	45	M4	1.5	0.75K	104	84	99	74	44	M5	0.8	H0.75K	135	120	115	64	45	M4	1.5	1.5K	104	84	99	77	50	M5	1.1	H1.5K	135	120	115	64	45	M4	1.5	2.2K	115	40	115	77	57	M6	1.5	H2.2K	135	120	115	64	45	M4	1.5	3.7K	115	40	115	83	67	M6	2.2	H3.7K	135	120	115	74	57	M4	2.5	5.5K	115	40	115	83	67	M6	2.3	H5.5K	160	145	142	76	55	M4	3.5	400V	7.5K	130	50	135	100	86	M6	4.2	H7.5K	160	145	142	96	75	M4	5.0	11K	160	75	164	111	92	M6	5.2	H11K	160	145	146	96	75	M4	6.0	15K	160	75	167	126	107	M6	7.0	H15K	220	200	195	105	70	M5	9.0
		(Unit mm)																																																																																																																																																																																		
Model	W	W1	H	D	D1	d	Mass (kg)	Model	W	W1	H	D	D1	d	Mass (kg)																																																																																																																																																																					
200V	0.4K	104	84	99	72	40	M5	0.6	400V	H0.4K	135	120	115	64	45	M4	1.5																																																																																																																																																																			
	0.75K	104	84	99	74	44	M5	0.8		H0.75K	135	120	115	64	45	M4	1.5																																																																																																																																																																			
	1.5K	104	84	99	77	50	M5	1.1		H1.5K	135	120	115	64	45	M4	1.5																																																																																																																																																																			
	2.2K	115	40	115	77	57	M6	1.5		H2.2K	135	120	115	64	45	M4	1.5																																																																																																																																																																			
	3.7K	115	40	115	83	67	M6	2.2		H3.7K	135	120	115	74	57	M4	2.5																																																																																																																																																																			
	5.5K	115	40	115	83	67	M6	2.3		H5.5K	160	145	142	76	55	M4	3.5																																																																																																																																																																			
400V	7.5K	130	50	135	100	86	M6	4.2		H7.5K	160	145	142	96	75	M4	5.0																																																																																																																																																																			
	11K	160	75	164	111	92	M6	5.2		H11K	160	145	146	96	75	M4	6.0																																																																																																																																																																			
	15K	160	75	167	126	107	M6	7.0		H15K	220	200	195	105	70	M5	9.0																																																																																																																																																																			

Name (model)	Specification and Structure																																																																																																																																																																																		
<p>DC reactor (for power supply coordination) FR-HEL-(H)□□K</p> 	<ul style="list-style-type: none"> Improves the power factor and reduces the harmonic current at the input side. Connect a DC reactor in the DC section of the inverter. Selection method <ul style="list-style-type: none"> Select a DC reactor according to the applied motor capacity. (When a general-purpose motor is used, select it according to the motor capacity even if the capacity is smaller than the inverter capacity.) Connection diagram <ul style="list-style-type: none"> Connect a DC reactor to the inverter terminals P1 and P. Before connecting, make sure to remove the jumper across the terminals P1 and P. (If the jumper is left attached, no power factor improvement can be obtained.) The connection cable between the reactor and the inverter should be as short as possible (5m or less).  <ul style="list-style-type: none"> Outline dimension <table border="1" data-bbox="370 660 1149 918"> <thead> <tr> <th colspan="2"></th> <th colspan="14">(Unit mm)</th> </tr> <tr> <th>Model</th> <th>W</th> <th>W1</th> <th>H</th> <th>D</th> <th>D1</th> <th>d</th> <th>Mass (kg)</th> <th>Model</th> <th>W</th> <th>W1</th> <th>H</th> <th>D</th> <th>D1</th> <th>d</th> <th>Mass (kg)</th> </tr> </thead> <tbody> <tr> <td rowspan="8">200V</td> <td>0.4K</td> <td>70</td> <td>60</td> <td>71</td> <td>61</td> <td>—</td> <td>M4</td> <td>0.4</td> <td rowspan="8">400V</td> <td>H0.4K</td> <td>90</td> <td>75</td> <td>78</td> <td>60</td> <td>—</td> <td>M5</td> <td>0.6</td> </tr> <tr> <td>0.75K</td> <td>85</td> <td>74</td> <td>81</td> <td>61</td> <td>—</td> <td>M4</td> <td>0.5</td> <td>H0.75K</td> <td>66</td> <td>50</td> <td>100</td> <td>70</td> <td>48</td> <td>M4</td> <td>0.8</td> </tr> <tr> <td>1.5K</td> <td>85</td> <td>74</td> <td>81</td> <td>70</td> <td>—</td> <td>M4</td> <td>0.8</td> <td>H1.5K</td> <td>66</td> <td>50</td> <td>100</td> <td>80</td> <td>54</td> <td>M4</td> <td>1</td> </tr> <tr> <td>2.2K</td> <td>85</td> <td>74</td> <td>81</td> <td>70</td> <td>—</td> <td>M4</td> <td>0.9</td> <td>H2.2K</td> <td>76</td> <td>50</td> <td>110</td> <td>80</td> <td>54</td> <td>M4</td> <td>1.3</td> </tr> <tr> <td>3.7K</td> <td>77</td> <td>55</td> <td>92</td> <td>82</td> <td>57</td> <td>M4</td> <td>1.5</td> <td>H3.7K</td> <td>86</td> <td>55</td> <td>120</td> <td>95</td> <td>69</td> <td>M4</td> <td>2.3</td> </tr> <tr> <td>5.5K</td> <td>77</td> <td>55</td> <td>92</td> <td>92</td> <td>67</td> <td>M4</td> <td>1.9</td> <td>H5.5K</td> <td>96</td> <td>60</td> <td>128</td> <td>100</td> <td>75</td> <td>M5</td> <td>3</td> </tr> <tr> <td>7.5K</td> <td>86</td> <td>60</td> <td>113</td> <td>98</td> <td>72</td> <td>M4</td> <td>2.5</td> <td>H7.5K</td> <td>96</td> <td>60</td> <td>128</td> <td>105</td> <td>80</td> <td>M5</td> <td>3.5</td> </tr> <tr> <td>11K</td> <td>105</td> <td>64</td> <td>133</td> <td>112</td> <td>79</td> <td>M6</td> <td>3.3</td> <td>H11K</td> <td>105</td> <td>75</td> <td>137</td> <td>110</td> <td>85</td> <td>M5</td> <td>4.5</td> </tr> <tr> <td>15K</td> <td>105</td> <td>64</td> <td>133</td> <td>115</td> <td>84</td> <td>M6</td> <td>4.1</td> <td>H15K</td> <td>105</td> <td>75</td> <td>152</td> <td>125</td> <td>95</td> <td>M5</td> <td>5</td> </tr> </tbody> </table>  <p>(Note) 1. The size of the cables used should be equal to or larger than that of the power supply cables (R/L1, S/L2, T/L3). (Refer to page 65.) 2. Approximately 93% of the power factor improving effect can be obtained (94.4% when calculated with 1 power factor for the fundamental wave according to the Architectural Standard Specifications (Electrical Installation) (2013 revision) supervised by the Ministry of Land, Infrastructure, Transport and Tourism of Japan). 3. This is a sample outline dimension drawing. The shape differs by the model. W1 and D1 indicate distances between installation holes. The installation hole size is indicated by d. 4. Install DC reactors (FR-HEL) on a horizontal or vertical surface. 5. Keep enough clearance around the reactor because it heats up. (Keep a clearance of minimum 10cm each on top and bottom and minimum 5cm each on right and left regardless of the installation orientation.)</p>			(Unit mm)														Model	W	W1	H	D	D1	d	Mass (kg)	Model	W	W1	H	D	D1	d	Mass (kg)	200V	0.4K	70	60	71	61	—	M4	0.4	400V	H0.4K	90	75	78	60	—	M5	0.6	0.75K	85	74	81	61	—	M4	0.5	H0.75K	66	50	100	70	48	M4	0.8	1.5K	85	74	81	70	—	M4	0.8	H1.5K	66	50	100	80	54	M4	1	2.2K	85	74	81	70	—	M4	0.9	H2.2K	76	50	110	80	54	M4	1.3	3.7K	77	55	92	82	57	M4	1.5	H3.7K	86	55	120	95	69	M4	2.3	5.5K	77	55	92	92	67	M4	1.9	H5.5K	96	60	128	100	75	M5	3	7.5K	86	60	113	98	72	M4	2.5	H7.5K	96	60	128	105	80	M5	3.5	11K	105	64	133	112	79	M6	3.3	H11K	105	75	137	110	85	M5	4.5	15K	105	64	133	115	84	M6	4.1	H15K	105	75	152	125	95	M5	5
		(Unit mm)																																																																																																																																																																																	
Model	W	W1	H	D	D1	d	Mass (kg)	Model	W	W1	H	D	D1	d	Mass (kg)																																																																																																																																																																				
200V	0.4K	70	60	71	61	—	M4	0.4	400V	H0.4K	90	75	78	60	—	M5	0.6																																																																																																																																																																		
	0.75K	85	74	81	61	—	M4	0.5		H0.75K	66	50	100	70	48	M4	0.8																																																																																																																																																																		
	1.5K	85	74	81	70	—	M4	0.8		H1.5K	66	50	100	80	54	M4	1																																																																																																																																																																		
	2.2K	85	74	81	70	—	M4	0.9		H2.2K	76	50	110	80	54	M4	1.3																																																																																																																																																																		
	3.7K	77	55	92	82	57	M4	1.5		H3.7K	86	55	120	95	69	M4	2.3																																																																																																																																																																		
	5.5K	77	55	92	92	67	M4	1.9		H5.5K	96	60	128	100	75	M5	3																																																																																																																																																																		
	7.5K	86	60	113	98	72	M4	2.5		H7.5K	96	60	128	105	80	M5	3.5																																																																																																																																																																		
	11K	105	64	133	112	79	M6	3.3		H11K	105	75	137	110	85	M5	4.5																																																																																																																																																																		
15K	105	64	133	115	84	M6	4.1	H15K	105	75	152	125	95	M5	5																																																																																																																																																																				
<p>EMC Directive compliant noise filter SF FR-E5NF-H□□K (400V class)</p>	<ul style="list-style-type: none"> A noise filter that complies with the European EMC Directive (EN61800-3 2nd Environment Category C3). <table border="1" data-bbox="370 1198 1189 1388"> <thead> <tr> <th rowspan="2">Noise filter model</th> <th rowspan="2">Applicable Inverter Model</th> <th rowspan="2">Intercompatibility attachment *1</th> <th colspan="3">Outline Dimension (Unit: mm)</th> <th rowspan="2">Mass (kg)</th> <th rowspan="2">Leakage current (mA) *2</th> <th rowspan="2">Loss (W)</th> </tr> <tr> <th>W</th> <th>H</th> <th>D</th> </tr> </thead> <tbody> <tr> <td>SF1306</td> <td>FR-F720PJ-0.4K to 1.5K</td> <td>—</td> <td>110</td> <td>200</td> <td>36.5</td> <td>0.7</td> <td>10</td> <td>7.3</td> </tr> <tr> <td>SF1309</td> <td>FR-F720PJ-2.2K, 3.7K</td> <td>FR-E5T</td> <td>200</td> <td>282</td> <td>57</td> <td>2.1</td> <td>15</td> <td>15</td> </tr> <tr> <td>FR-E5NF-H0.75K</td> <td>FR-F740PJ-0.4K, 0.75K</td> <td>—</td> <td>140</td> <td>210</td> <td>46</td> <td>1.1</td> <td>22.6</td> <td>5.5</td> </tr> <tr> <td>FR-E5NF-H3.7K</td> <td>FR-F740PJ-1.5K to 3.7K</td> <td>—</td> <td>140</td> <td>210</td> <td>46</td> <td>1.2</td> <td>44.5</td> <td>8</td> </tr> <tr> <td>FR-E5NF-H7.5K</td> <td>FR-F740PJ-5.5K, 7.5K</td> <td>—</td> <td>220</td> <td>210</td> <td>47</td> <td>2</td> <td>68.4</td> <td>15</td> </tr> </tbody> </table> <table border="1" data-bbox="370 1400 1189 1534"> <thead> <tr> <th rowspan="2">Noise filter model</th> <th rowspan="2">Applicable Inverter Model</th> <th rowspan="2">Intercompatibility attachment *1</th> <th colspan="4">Outline Dimension (Unit: mm)</th> <th rowspan="2">Mass (kg)</th> <th rowspan="2">Leakage current (mA) *2</th> <th rowspan="2">Loss (W)</th> </tr> <tr> <th>W</th> <th>H</th> <th>D</th> <th>D1</th> </tr> </thead> <tbody> <tr> <td>SF1260</td> <td>FR-F720PJ-5.5K to 11K</td> <td>FR-A5AT03</td> <td>222</td> <td>468</td> <td>80</td> <td>29</td> <td>5</td> <td>440</td> <td>118</td> </tr> <tr> <td>SF1261</td> <td>FR-F720PJ-15K</td> <td>FR-AAT02</td> <td>253</td> <td>600</td> <td>86</td> <td>28.5</td> <td>9.3</td> <td>71</td> <td>37</td> </tr> <tr> <td>SF1175</td> <td>FR-F740PJ-11K, 15K</td> <td>FR-AAT02</td> <td>253</td> <td>530</td> <td>60</td> <td>25</td> <td>4.7</td> <td>76</td> <td>56</td> </tr> </tbody> </table>  <p>*1 The depth required for installation will increase by 12mm when the intercompatibility attachment is installed. *2 The indicated leakage current is equivalent to one phase of the three-phase three-wire Y-connection power supply. For the three-phase three-wire Δ-connection power supply, the value becomes approximately three times larger than the listed value. (Note) This is a sample outline dimension drawing. The shape differs by the model.</p> <ul style="list-style-type: none"> Countermeasures for leakage current Take following measures to prevent a malfunction of peripheral device or an electric shock accident due to leakage current. <ol style="list-style-type: none"> Ground (earth) the noise filter before connecting the power supply. Check that the noise filter is grounded (earthed) securely through the enclosure. Select an earth leakage circuit breaker or earth leakage relay to allow for the leakage current of noise filter. An earth leakage circuit breaker may not be used when the leakage current of noise filter is too large. Use an earth leakage relay with a large rated sensitivity current. If an earth leakage circuit breaker or earth leakage relay cannot be used, securely perform grounding (earthing) as directed in (1). 	Noise filter model	Applicable Inverter Model	Intercompatibility attachment *1	Outline Dimension (Unit: mm)			Mass (kg)	Leakage current (mA) *2	Loss (W)	W	H	D	SF1306	FR-F720PJ-0.4K to 1.5K	—	110	200	36.5	0.7	10	7.3	SF1309	FR-F720PJ-2.2K, 3.7K	FR-E5T	200	282	57	2.1	15	15	FR-E5NF-H0.75K	FR-F740PJ-0.4K, 0.75K	—	140	210	46	1.1	22.6	5.5	FR-E5NF-H3.7K	FR-F740PJ-1.5K to 3.7K	—	140	210	46	1.2	44.5	8	FR-E5NF-H7.5K	FR-F740PJ-5.5K, 7.5K	—	220	210	47	2	68.4	15	Noise filter model	Applicable Inverter Model	Intercompatibility attachment *1	Outline Dimension (Unit: mm)				Mass (kg)	Leakage current (mA) *2	Loss (W)	W	H	D	D1	SF1260	FR-F720PJ-5.5K to 11K	FR-A5AT03	222	468	80	29	5	440	118	SF1261	FR-F720PJ-15K	FR-AAT02	253	600	86	28.5	9.3	71	37	SF1175	FR-F740PJ-11K, 15K	FR-AAT02	253	530	60	25	4.7	76	56																																																																													
Noise filter model	Applicable Inverter Model				Intercompatibility attachment *1	Outline Dimension (Unit: mm)					Mass (kg)	Leakage current (mA) *2	Loss (W)																																																																																																																																																																						
		W	H	D																																																																																																																																																																															
SF1306	FR-F720PJ-0.4K to 1.5K	—	110	200	36.5	0.7	10	7.3																																																																																																																																																																											
SF1309	FR-F720PJ-2.2K, 3.7K	FR-E5T	200	282	57	2.1	15	15																																																																																																																																																																											
FR-E5NF-H0.75K	FR-F740PJ-0.4K, 0.75K	—	140	210	46	1.1	22.6	5.5																																																																																																																																																																											
FR-E5NF-H3.7K	FR-F740PJ-1.5K to 3.7K	—	140	210	46	1.2	44.5	8																																																																																																																																																																											
FR-E5NF-H7.5K	FR-F740PJ-5.5K, 7.5K	—	220	210	47	2	68.4	15																																																																																																																																																																											
Noise filter model	Applicable Inverter Model	Intercompatibility attachment *1	Outline Dimension (Unit: mm)				Mass (kg)	Leakage current (mA) *2	Loss (W)																																																																																																																																																																										
			W	H	D	D1																																																																																																																																																																													
SF1260	FR-F720PJ-5.5K to 11K	FR-A5AT03	222	468	80	29	5	440	118																																																																																																																																																																										
SF1261	FR-F720PJ-15K	FR-AAT02	253	600	86	28.5	9.3	71	37																																																																																																																																																																										
SF1175	FR-F740PJ-11K, 15K	FR-AAT02	253	530	60	25	4.7	76	56																																																																																																																																																																										
<p>Radio noise filter FR-BIF (200V class) FR-BIF-H (400V class)</p> 	<ul style="list-style-type: none"> Outline dimension   <p>(Note) 1. The radio noise filter cannot be connected to the inverter output side. 2. Keep the wiring as short as possible and connect it to the inverter terminal block. 3. The radio noise filter cannot be connected when a Filterpack is connected.</p>																																																																																																																																																																																		

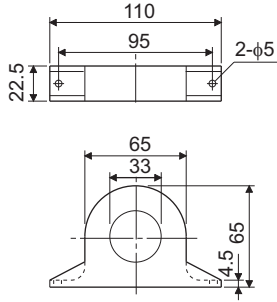
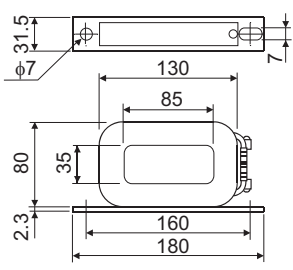
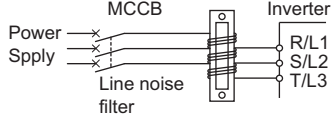
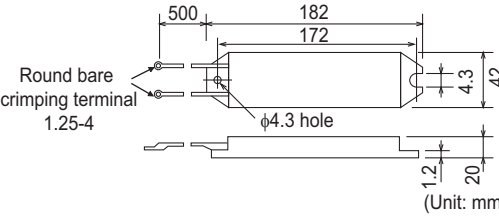
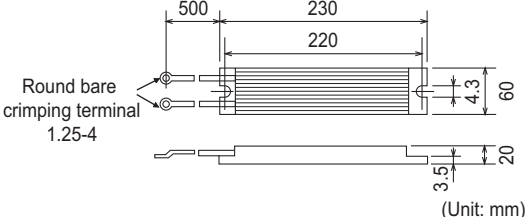
Features
 Connection example
 Standard specs.
 Outline dimensions
 Terminal connection diagrams
 Terminal specs.
 Operation panel
 Parameter unit
 FR Configurator
 Parameter list
 Parameter descriptions
 Protective functions
 Options
 Precautions
 Motor
 IPM motor control
 Compatibility
 Warranty

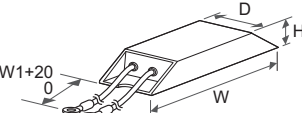
Name (model)	Specification and Structure																																																																																																																																																																										
<p>Line noise filter FR-BSF01 (for small capacities) FR-BLF</p> 	<ul style="list-style-type: none"> Install an EMC filter (ferrite core) to reduce the electromagnetic noise generated from the inverter. Effective in the range from about 0.5MHz to 5MHz. Outline dimension <div style="display: flex; justify-content: space-around;"> <div style="text-align: center;"> <p>FR-BSF01</p>  </div> <div style="text-align: center;"> <p>FR-BLF</p>  </div> <div style="text-align: center;">  <p>(Note) 1. Wind each phase for three times (4T) in the same direction. (The greater the number of turns, the more effective result is obtained.) When using several line noise filters to make 4T or more, wind the phases (cables) together. Do not use a different line noise filter for different phases. 2. When the cables are too thick to be wound, run each cable (phase) through four or more filters installed in series in one direction. 3. The filter can be used in the same way as the output side. When using filters at the output side, do not wind the cable more than 3 times (4T) for each filter because the filter may overheat. 4. Use FR-BSF01 for small-capacity inverters. A thick cable of 38mm² or more is not applicable. For such cable, use FR-BLF. 5. Do not wind the earthing (grounding) cable.</p> </div> </div>																																																																																																																																																																										
<p>Brake resistor MRS type, MYS type</p>	<ul style="list-style-type: none"> Outline dimension <div style="display: flex; justify-content: space-around;"> <div style="text-align: center;"> <p>MRS type</p>  <p>(Unit: mm)</p> </div> <div style="text-align: center;"> <p>MYS type</p>  <p>(Unit: mm)</p> </div> </div> <table border="1" style="width: 100%; border-collapse: collapse; text-align: center;"> <thead> <tr> <th colspan="2">Resistor model</th> <th>Control torque/ Permissible duty</th> <th>Resistance (Ω)</th> <th>Permissible power (W)</th> <th>Applicable motor capacity (kW)</th> </tr> </thead> <tbody> <tr> <td rowspan="6">200V</td> <td rowspan="3">MRS type</td> <td>MRS120W200</td> <td>200</td> <td>15</td> <td>0.4</td> </tr> <tr> <td>MRS120W100</td> <td>100</td> <td>30</td> <td>0.75</td> </tr> <tr> <td>MRS120W60</td> <td>60</td> <td>55</td> <td>1.5</td> </tr> <tr> <td rowspan="3">MYS type</td> <td rowspan="2">MRS120W40</td> <td>100% torque/3%ED</td> <td>40</td> <td>80</td> <td>2.2</td> </tr> <tr> <td>150% torque/3%ED</td> <td>40</td> <td>80</td> <td>3.7</td> </tr> <tr> <td>MYS220W50 *</td> <td>100% torque/6%ED</td> <td>50/2</td> <td>2×80</td> <td>3.7</td> </tr> </tbody> </table> <p>(Note) 1. The brake resistor temperature may become 200°C or higher due to frequent operation. Caution is required to ensure proper installation and heat radiation. 2. Remove the jumper across the terminals P/+ and P1 only when a Filterpack or DC reactor is connected. Do not remove the jumper in other cases.</p> <p>* Two resistors in parallel</p>	Resistor model		Control torque/ Permissible duty	Resistance (Ω)	Permissible power (W)	Applicable motor capacity (kW)	200V	MRS type	MRS120W200	200	15	0.4	MRS120W100	100	30	0.75	MRS120W60	60	55	1.5	MYS type	MRS120W40	100% torque/3%ED	40	80	2.2	150% torque/3%ED	40	80	3.7	MYS220W50 *	100% torque/6%ED	50/2	2×80	3.7																																																																																																																																							
Resistor model		Control torque/ Permissible duty	Resistance (Ω)	Permissible power (W)	Applicable motor capacity (kW)																																																																																																																																																																						
200V	MRS type	MRS120W200	200	15	0.4																																																																																																																																																																						
		MRS120W100	100	30	0.75																																																																																																																																																																						
		MRS120W60	60	55	1.5																																																																																																																																																																						
	MYS type	MRS120W40	100% torque/3%ED	40	80	2.2																																																																																																																																																																					
			150% torque/3%ED	40	80	3.7																																																																																																																																																																					
		MYS220W50 *	100% torque/6%ED	50/2	2×80	3.7																																																																																																																																																																					
<p>High-duty brake resistor FR-ABR-(H)□□K</p> 	<ul style="list-style-type: none"> Outline dimension <table border="1" style="width: 100%; border-collapse: collapse; text-align: center;"> <thead> <tr> <th rowspan="2">Brake resistor model</th> <th rowspan="2">Permissible brake duty</th> <th colspan="4">Outline Dimension</th> <th rowspan="2">Resistance (Ω)</th> <th rowspan="2">Approximate mass (kg)</th> <th rowspan="2">Brake resistor model</th> <th rowspan="2">Permissible brake duty</th> <th colspan="4">Outline Dimension</th> <th rowspan="2">Resistance (Ω)</th> <th rowspan="2">Approximate mass (kg)</th> </tr> <tr> <th>W</th> <th>W1</th> <th>D</th> <th>H</th> <th>W</th> <th>W1</th> <th>D</th> <th>H</th> </tr> </thead> <tbody> <tr> <td rowspan="10">200V</td> <td>FR-ABR-0.4K</td> <td>10%</td> <td>140</td> <td>500</td> <td>40</td> <td>21</td> <td>200</td> <td>0.2</td> <td rowspan="10">400V</td> <td>FR-ABR-H0.4K</td> <td>10%</td> <td>115</td> <td>500</td> <td>40</td> <td>21</td> <td>1200</td> <td>0.2</td> </tr> <tr> <td>FR-ABR-0.75K</td> <td>10%</td> <td>215</td> <td>500</td> <td>40</td> <td>21</td> <td>100</td> <td>0.4</td> <td>FR-ABR-H0.75K</td> <td>10%</td> <td>140</td> <td>500</td> <td>40</td> <td>21</td> <td>700</td> <td>0.2</td> </tr> <tr> <td>FR-ABR-2.2K #1</td> <td>10%</td> <td>240</td> <td>500</td> <td>50</td> <td>26</td> <td>60</td> <td>0.5</td> <td>FR-ABR-H1.5K</td> <td>10%</td> <td>215</td> <td>500</td> <td>40</td> <td>21</td> <td>350</td> <td>0.4</td> </tr> <tr> <td>FR-ABR-3.7K</td> <td>10%</td> <td>215</td> <td>500</td> <td>61</td> <td>33</td> <td>40</td> <td>0.8</td> <td>FR-ABR-H2.2K</td> <td>10%</td> <td>240</td> <td>500</td> <td>50</td> <td>26</td> <td>250</td> <td>0.5</td> </tr> <tr> <td>FR-ABR-5.5K</td> <td>10%</td> <td>335</td> <td>500</td> <td>61</td> <td>33</td> <td>25</td> <td>1.3</td> <td>FR-ABR-H3.7K</td> <td>10%</td> <td>215</td> <td>500</td> <td>61</td> <td>33</td> <td>150</td> <td>0.8</td> </tr> <tr> <td>FR-ABR-7.5K</td> <td>10%</td> <td>400</td> <td>500</td> <td>80</td> <td>40</td> <td>20</td> <td>2.2</td> <td>FR-ABR-H5.5K</td> <td>10%</td> <td>335</td> <td>500</td> <td>61</td> <td>33</td> <td>110</td> <td>1.3</td> </tr> <tr> <td>FR-ABR-11K</td> <td>6%</td> <td>400</td> <td>700</td> <td>100</td> <td>50</td> <td>13</td> <td>3.5</td> <td>FR-ABR-H7.5K</td> <td>10%</td> <td>400</td> <td>500</td> <td>80</td> <td>40</td> <td>75</td> <td>2.2</td> </tr> <tr> <td>FR-ABR-15K #2</td> <td>6%</td> <td>300</td> <td>700</td> <td>100</td> <td>50</td> <td>18</td> <td>2.4 (×1/2)</td> <td>FR-ABR-H11K</td> <td>6%</td> <td>400</td> <td>700</td> <td>100</td> <td>50</td> <td>52</td> <td>3.2</td> </tr> <tr> <td></td> <td></td> <td></td> <td></td> <td></td> <td></td> <td></td> <td></td> <td>FR-ABR-H15K #3</td> <td>6%</td> <td>300</td> <td>700</td> <td>100</td> <td>50</td> <td>18</td> <td>2.4 (×2)</td> </tr> </tbody> </table> <p>#1 For both 1.5K and 2.2K #2 Connect two 15K resistors (18Ω) in parallel. #3 Connect two H15K resistors (18Ω) in series. The resistor model name (FR-ABR-15K) is written on its body. (Same resistor as the one for the 200V class 15K inverter)</p> <div style="text-align: center;">  <p>(Note) 1. Set the regenerative brake duty not to exceed the permissible brake duty listed in the table. 2. The brake resistor temperature may become 300 °C or higher due to frequent operation. Caution is required to ensure proper installation and heat radiation. 3. Do not remove the jumper across terminals P/+ and P1 except for connecting a Filterpack or DC reactor. 4. The MYS type resistor can be used. However, pay attention to the permissible brake duty. 5. Always install a thermal relay when using a brake resistor whose capacity is 11K or higher.</p> </div>	Brake resistor model	Permissible brake duty	Outline Dimension				Resistance (Ω)	Approximate mass (kg)	Brake resistor model	Permissible brake duty	Outline Dimension				Resistance (Ω)	Approximate mass (kg)	W	W1	D	H	W	W1	D	H	200V	FR-ABR-0.4K	10%	140	500	40	21	200	0.2	400V	FR-ABR-H0.4K	10%	115	500	40	21	1200	0.2	FR-ABR-0.75K	10%	215	500	40	21	100	0.4	FR-ABR-H0.75K	10%	140	500	40	21	700	0.2	FR-ABR-2.2K #1	10%	240	500	50	26	60	0.5	FR-ABR-H1.5K	10%	215	500	40	21	350	0.4	FR-ABR-3.7K	10%	215	500	61	33	40	0.8	FR-ABR-H2.2K	10%	240	500	50	26	250	0.5	FR-ABR-5.5K	10%	335	500	61	33	25	1.3	FR-ABR-H3.7K	10%	215	500	61	33	150	0.8	FR-ABR-7.5K	10%	400	500	80	40	20	2.2	FR-ABR-H5.5K	10%	335	500	61	33	110	1.3	FR-ABR-11K	6%	400	700	100	50	13	3.5	FR-ABR-H7.5K	10%	400	500	80	40	75	2.2	FR-ABR-15K #2	6%	300	700	100	50	18	2.4 (×1/2)	FR-ABR-H11K	6%	400	700	100	50	52	3.2									FR-ABR-H15K #3	6%	300	700	100	50	18	2.4 (×2)
Brake resistor model	Permissible brake duty			Outline Dimension								Resistance (Ω)	Approximate mass (kg)	Brake resistor model	Permissible brake duty			Outline Dimension				Resistance (Ω)	Approximate mass (kg)																																																																																																																																																				
		W	W1	D	H	W	W1	D	H																																																																																																																																																																		
200V	FR-ABR-0.4K	10%	140	500	40	21	200	0.2	400V	FR-ABR-H0.4K	10%	115	500	40	21	1200	0.2																																																																																																																																																										
	FR-ABR-0.75K	10%	215	500	40	21	100	0.4		FR-ABR-H0.75K	10%	140	500	40	21	700	0.2																																																																																																																																																										
	FR-ABR-2.2K #1	10%	240	500	50	26	60	0.5		FR-ABR-H1.5K	10%	215	500	40	21	350	0.4																																																																																																																																																										
	FR-ABR-3.7K	10%	215	500	61	33	40	0.8		FR-ABR-H2.2K	10%	240	500	50	26	250	0.5																																																																																																																																																										
	FR-ABR-5.5K	10%	335	500	61	33	25	1.3		FR-ABR-H3.7K	10%	215	500	61	33	150	0.8																																																																																																																																																										
	FR-ABR-7.5K	10%	400	500	80	40	20	2.2		FR-ABR-H5.5K	10%	335	500	61	33	110	1.3																																																																																																																																																										
	FR-ABR-11K	6%	400	700	100	50	13	3.5		FR-ABR-H7.5K	10%	400	500	80	40	75	2.2																																																																																																																																																										
	FR-ABR-15K #2	6%	300	700	100	50	18	2.4 (×1/2)		FR-ABR-H11K	6%	400	700	100	50	52	3.2																																																																																																																																																										
										FR-ABR-H15K #3	6%	300	700	100	50	18	2.4 (×2)																																																																																																																																																										

Name (model)	Specification and Structure																																																																																																																																																																																																																																																																														
<p>● Provides a braking capability greater than that is provided by an external brake resistor. This option can also be connected to the inverters without built-in brake transistors. Three types of discharging resistors are available. Make a selection according to the required braking torque.</p> <p>● Specification</p> <p>[Brake unit]</p> <table border="1" style="width: 100%; text-align: center;"> <tr> <th rowspan="2">Model FR-BU2-□</th> <th colspan="5">200V</th> <th colspan="3">400V</th> </tr> <tr> <th>1.5K</th> <th>3.7K</th> <th>7.5K</th> <th>15K</th> <th>30K</th> <th>H7.5K</th> <th>H15K</th> <th>H30K</th> </tr> <tr> <td>Applicable motor capacity</td> <td colspan="8">The applicable capacity differs by the braking torque and the operation rate (%ED).</td> </tr> <tr> <td>Connected brake resistor</td> <td colspan="8">GRZG type, FR-BR (For the combination, refer to the table below.)</td> </tr> <tr> <td>Multiple (parallel) driving</td> <td colspan="8">Max.10 units (However, the torque is limited by the permissible current of the connected inverter.)</td> </tr> <tr> <td>Approximate mass (kg)</td> <td>0.9</td> <td>0.9</td> <td>0.9</td> <td>0.9</td> <td>1.4</td> <td>0.9</td> <td>0.9</td> <td>1.4</td> </tr> </table> <p>[Discharging resistor]</p> <table border="1" style="width: 100%; text-align: center;"> <tr> <th rowspan="2">Model GRZG type</th> <th colspan="4">200V</th> <th colspan="4">400V</th> <th rowspan="2">Model FR-BR-□</th> <th colspan="2">200V</th> <th colspan="2">400V</th> </tr> <tr> <th>GZG300W-50Ω</th> <th>GRZG200-10Ω</th> <th>GRZG300-5Ω</th> <th>GRZG400-2Ω</th> <th>GRZG200-10Ω</th> <th>GRZG300-5Ω</th> <th>GRZG400-2Ω</th> <th>15K</th> <th>30K</th> <th>H15K</th> <th>H30K</th> </tr> <tr> <td>Number of connectable units</td> <td>1 unit</td> <td>3 in series</td> <td>4 in series</td> <td>6 in series</td> <td>6 in series</td> <td>8 in series</td> <td>12 in series</td> <td rowspan="2">Discharging resistor combined resistance (Ω)</td> <td>8</td> <td>4</td> <td>32</td> <td>16</td> </tr> <tr> <td>Discharging resistor combined resistance (Ω)</td> <td>50</td> <td>30</td> <td>20</td> <td>12</td> <td>60</td> <td>40</td> <td>24</td> <td>Continuous operation permissible power (W)</td> <td>990</td> <td>1990</td> <td>990</td> <td>1990</td> </tr> <tr> <td>Continuous operation permissible power (W)</td> <td>100</td> <td>300</td> <td>600</td> <td>1200</td> <td>600</td> <td>1200</td> <td>2400</td> <td>Approximate mass (kg)</td> <td>15</td> <td>30</td> <td>15</td> <td>30</td> </tr> </table> <p>[Resistor unit]</p> <p>● Combination between the brake unit and the resistor unit</p> <table border="1" style="width: 100%; text-align: center;"> <tr> <th rowspan="2">Brake unit model</th> <th colspan="2">Discharging resistor model or resistor unit model</th> </tr> <tr> <th>GRZG type</th> <th>FR-BR</th> </tr> <tr> <td rowspan="5">200V class</td> <td>FR-BU2-1.5K</td> <td>GZG 300W-50Ω (1 unit)</td> </tr> <tr> <td>FR-BU2-3.7K</td> <td>GRZG 200-10Ω (3 in parallel)</td> </tr> <tr> <td>FR-BU2-7.5K</td> <td>GRZG 300-5Ω (4 in parallel)</td> </tr> <tr> <td>FR-BU2-15K</td> <td>GRZG 400-2Ω (6 in parallel)</td> </tr> <tr> <td>FR-BU2-30K</td> <td>—</td> </tr> <tr> <td rowspan="4">400V class</td> <td>FR-BU2-H7.5K</td> <td>GRZG 200-10Ω (6 in parallel)</td> </tr> <tr> <td>FR-BU2-H15K</td> <td>GRZG 300-5Ω (8 in parallel)</td> </tr> <tr> <td>FR-BU2-H30K</td> <td>GRZG 400-2Ω (12 in parallel)</td> </tr> <tr> <td>FR-BR-15K</td> <td>FR-BR-15K</td> </tr> <tr> <td>FR-BR-30K</td> <td>FR-BR-30K</td> </tr> <tr> <td>FR-BR-H15K</td> <td>FR-BR-H15K</td> </tr> <tr> <td>FR-BR-H30K</td> <td>FR-BR-H30K</td> </tr> </table> <p>● Selection method</p> <p>[GRZG type]</p> <p>The maximum temperature rise of the discharging resistors is about 100°C. Use heat-resistant wires to perform wiring, and make sure that they will not come in contact with resistors.</p> <table border="1" style="width: 100%; text-align: center;"> <tr> <th rowspan="2">Power supply voltage</th> <th rowspan="2">Motor (kW)</th> <th colspan="10">Braking torque</th> </tr> <tr> <th>0.4</th> <th>0.75</th> <th>1.5</th> <th>2.2</th> <th>3.7</th> <th>5.5</th> <th>7.5</th> <th>11</th> <th>15</th> </tr> <tr> <td rowspan="2">200V class</td> <td>50% 30s</td> <td colspan="2">FR-BU2-1.5K</td> <td colspan="2">FR-BU2-3.7K</td> <td colspan="2">FR-BU2-7.5K</td> <td colspan="4">FR-BU2-15K</td> </tr> <tr> <td>100% 30s</td> <td>FR-BU2-1.5K</td> <td>FR-BU2-3.7K</td> <td colspan="2">FR-BU2-7.5K</td> <td colspan="2">FR-BU2-15K</td> <td colspan="4">2×FR-BU2-15K^{*1}</td> </tr> <tr> <td rowspan="2">400V class</td> <td>50% 30s</td> <td colspan="2">—^{*2}</td> <td colspan="4">FR-BU2-H7.5K</td> <td colspan="4">FR-BU2-H15K</td> </tr> <tr> <td>100% 30s</td> <td colspan="2">—^{*2}</td> <td colspan="2">FR-BU2-H7.5K</td> <td colspan="2">FR-BU2-H15K</td> <td colspan="4">FR-BU2-H30K</td> </tr> </table> <p>*1 The number next to the model name indicates the number of connectable units in parallel. *2 The 400V class 1.5K or lower capacity inverters cannot be used with brake units. When using brake units with inverters, use 2.2K or higher capacity inverters.</p> <p>[FR-BR]</p> <p>The maximum temperature rise of the resistor unit is about 100°C. Therefore, use heat-resistant wires (such as glass wires). %ED at short-time rating when braking torque is 100%</p> <table border="1" style="width: 100%; text-align: center;"> <tr> <th colspan="2">Motor capacity</th> <th>5.5kW</th> <th>7.5kW</th> <th>11kW</th> <th>15kW</th> </tr> <tr> <td rowspan="2">200V class</td> <td>FR-BU2-15K</td> <td>80</td> <td>40</td> <td>15</td> <td>10</td> </tr> <tr> <td>FR-BU2-30K</td> <td>—</td> <td>—</td> <td>65</td> <td>30</td> </tr> <tr> <td rowspan="2">400V class</td> <td>FR-BU2-H15K</td> <td>80</td> <td>40</td> <td>15</td> <td>10</td> </tr> <tr> <td>FR-BU2-H30K</td> <td>—</td> <td>—</td> <td>65</td> <td>30</td> </tr> </table> <p>Braking torque (%) at 10%ED in short-time rating of 15s(%)</p> <table border="1" style="width: 100%; text-align: center;"> <tr> <th colspan="2">Motor capacity</th> <th>5.5kW</th> <th>7.5kW</th> <th>11kW</th> <th>15kW</th> </tr> <tr> <td rowspan="2">200V class</td> <td>FR-BU2-15K</td> <td>280</td> <td>200</td> <td>120</td> <td>100</td> </tr> <tr> <td>FR-BU2-30K</td> <td>—</td> <td>—</td> <td>260</td> <td>180</td> </tr> <tr> <td rowspan="2">400V class</td> <td>FR-BU2-H15K</td> <td>280</td> <td>200</td> <td>120</td> <td>100</td> </tr> <tr> <td>FR-BU2-H30K</td> <td>—</td> <td>—</td> <td>260</td> <td>180</td> </tr> </table> <p>Regeneration duty factor (operation frequency)%ED = $\frac{t_b}{t_c} \times 100$ $t_b < 15s$ (continuous operation time)</p> <div style="display: flex; justify-content: space-around;"> <div style="text-align: center;"> <p>Example 1 Travel operation</p> </div> <div style="text-align: center;"> <p>Example 2 Lift operation</p> </div> </div>	Model FR-BU2-□	200V					400V			1.5K	3.7K	7.5K	15K	30K	H7.5K	H15K	H30K	Applicable motor capacity	The applicable capacity differs by the braking torque and the operation rate (%ED).								Connected brake resistor	GRZG type, FR-BR (For the combination, refer to the table below.)								Multiple (parallel) driving	Max.10 units (However, the torque is limited by the permissible current of the connected inverter.)								Approximate mass (kg)	0.9	0.9	0.9	0.9	1.4	0.9	0.9	1.4	Model GRZG type	200V				400V				Model FR-BR-□	200V		400V		GZG300W-50Ω	GRZG200-10Ω	GRZG300-5Ω	GRZG400-2Ω	GRZG200-10Ω	GRZG300-5Ω	GRZG400-2Ω	15K	30K	H15K	H30K	Number of connectable units	1 unit	3 in series	4 in series	6 in series	6 in series	8 in series	12 in series	Discharging resistor combined resistance (Ω)	8	4	32	16	Discharging resistor combined resistance (Ω)	50	30	20	12	60	40	24	Continuous operation permissible power (W)	990	1990	990	1990	Continuous operation permissible power (W)	100	300	600	1200	600	1200	2400	Approximate mass (kg)	15	30	15	30	Brake unit model	Discharging resistor model or resistor unit model		GRZG type	FR-BR	200V class	FR-BU2-1.5K	GZG 300W-50Ω (1 unit)	FR-BU2-3.7K	GRZG 200-10Ω (3 in parallel)	FR-BU2-7.5K	GRZG 300-5Ω (4 in parallel)	FR-BU2-15K	GRZG 400-2Ω (6 in parallel)	FR-BU2-30K	—	400V class	FR-BU2-H7.5K	GRZG 200-10Ω (6 in parallel)	FR-BU2-H15K	GRZG 300-5Ω (8 in parallel)	FR-BU2-H30K	GRZG 400-2Ω (12 in parallel)	FR-BR-15K	FR-BR-15K	FR-BR-30K	FR-BR-30K	FR-BR-H15K	FR-BR-H15K	FR-BR-H30K	FR-BR-H30K	Power supply voltage	Motor (kW)	Braking torque										0.4	0.75	1.5	2.2	3.7	5.5	7.5	11	15	200V class	50% 30s	FR-BU2-1.5K		FR-BU2-3.7K		FR-BU2-7.5K		FR-BU2-15K				100% 30s	FR-BU2-1.5K	FR-BU2-3.7K	FR-BU2-7.5K		FR-BU2-15K		2×FR-BU2-15K ^{*1}				400V class	50% 30s	— ^{*2}		FR-BU2-H7.5K				FR-BU2-H15K				100% 30s	— ^{*2}		FR-BU2-H7.5K		FR-BU2-H15K		FR-BU2-H30K				Motor capacity		5.5kW	7.5kW	11kW	15kW	200V class	FR-BU2-15K	80	40	15	10	FR-BU2-30K	—	—	65	30	400V class	FR-BU2-H15K	80	40	15	10	FR-BU2-H30K	—	—	65	30	Motor capacity		5.5kW	7.5kW	11kW	15kW	200V class	FR-BU2-15K	280	200	120	100	FR-BU2-30K	—	—	260	180	400V class	FR-BU2-H15K	280	200	120	100	FR-BU2-H30K	—	—	260	180
		Model FR-BU2-□	200V					400V																																																																																																																																																																																																																																																																							
	1.5K		3.7K	7.5K	15K	30K	H7.5K	H15K	H30K																																																																																																																																																																																																																																																																						
	Applicable motor capacity	The applicable capacity differs by the braking torque and the operation rate (%ED).																																																																																																																																																																																																																																																																													
	Connected brake resistor	GRZG type, FR-BR (For the combination, refer to the table below.)																																																																																																																																																																																																																																																																													
	Multiple (parallel) driving	Max.10 units (However, the torque is limited by the permissible current of the connected inverter.)																																																																																																																																																																																																																																																																													
	Approximate mass (kg)	0.9	0.9	0.9	0.9	1.4	0.9	0.9	1.4																																																																																																																																																																																																																																																																						
	Model GRZG type	200V				400V				Model FR-BR-□	200V		400V																																																																																																																																																																																																																																																																		
		GZG300W-50Ω	GRZG200-10Ω	GRZG300-5Ω	GRZG400-2Ω	GRZG200-10Ω	GRZG300-5Ω	GRZG400-2Ω	15K		30K	H15K	H30K																																																																																																																																																																																																																																																																		
	Number of connectable units	1 unit	3 in series	4 in series	6 in series	6 in series	8 in series	12 in series	Discharging resistor combined resistance (Ω)	8	4	32	16																																																																																																																																																																																																																																																																		
	Discharging resistor combined resistance (Ω)	50	30	20	12	60	40	24		Continuous operation permissible power (W)	990	1990	990	1990																																																																																																																																																																																																																																																																	
	Continuous operation permissible power (W)	100	300	600	1200	600	1200	2400	Approximate mass (kg)	15	30	15	30																																																																																																																																																																																																																																																																		
	Brake unit model	Discharging resistor model or resistor unit model																																																																																																																																																																																																																																																																													
		GRZG type	FR-BR																																																																																																																																																																																																																																																																												
	200V class	FR-BU2-1.5K	GZG 300W-50Ω (1 unit)																																																																																																																																																																																																																																																																												
FR-BU2-3.7K		GRZG 200-10Ω (3 in parallel)																																																																																																																																																																																																																																																																													
FR-BU2-7.5K		GRZG 300-5Ω (4 in parallel)																																																																																																																																																																																																																																																																													
FR-BU2-15K		GRZG 400-2Ω (6 in parallel)																																																																																																																																																																																																																																																																													
FR-BU2-30K		—																																																																																																																																																																																																																																																																													
400V class	FR-BU2-H7.5K	GRZG 200-10Ω (6 in parallel)																																																																																																																																																																																																																																																																													
	FR-BU2-H15K	GRZG 300-5Ω (8 in parallel)																																																																																																																																																																																																																																																																													
	FR-BU2-H30K	GRZG 400-2Ω (12 in parallel)																																																																																																																																																																																																																																																																													
	FR-BR-15K	FR-BR-15K																																																																																																																																																																																																																																																																													
FR-BR-30K	FR-BR-30K																																																																																																																																																																																																																																																																														
FR-BR-H15K	FR-BR-H15K																																																																																																																																																																																																																																																																														
FR-BR-H30K	FR-BR-H30K																																																																																																																																																																																																																																																																														
Power supply voltage	Motor (kW)	Braking torque																																																																																																																																																																																																																																																																													
		0.4	0.75	1.5	2.2	3.7	5.5	7.5	11	15																																																																																																																																																																																																																																																																					
200V class	50% 30s	FR-BU2-1.5K		FR-BU2-3.7K		FR-BU2-7.5K		FR-BU2-15K																																																																																																																																																																																																																																																																							
	100% 30s	FR-BU2-1.5K	FR-BU2-3.7K	FR-BU2-7.5K		FR-BU2-15K		2×FR-BU2-15K ^{*1}																																																																																																																																																																																																																																																																							
400V class	50% 30s	— ^{*2}		FR-BU2-H7.5K				FR-BU2-H15K																																																																																																																																																																																																																																																																							
	100% 30s	— ^{*2}		FR-BU2-H7.5K		FR-BU2-H15K		FR-BU2-H30K																																																																																																																																																																																																																																																																							
Motor capacity		5.5kW	7.5kW	11kW	15kW																																																																																																																																																																																																																																																																										
200V class	FR-BU2-15K	80	40	15	10																																																																																																																																																																																																																																																																										
	FR-BU2-30K	—	—	65	30																																																																																																																																																																																																																																																																										
400V class	FR-BU2-H15K	80	40	15	10																																																																																																																																																																																																																																																																										
	FR-BU2-H30K	—	—	65	30																																																																																																																																																																																																																																																																										
Motor capacity		5.5kW	7.5kW	11kW	15kW																																																																																																																																																																																																																																																																										
200V class	FR-BU2-15K	280	200	120	100																																																																																																																																																																																																																																																																										
	FR-BU2-30K	—	—	260	180																																																																																																																																																																																																																																																																										
400V class	FR-BU2-H15K	280	200	120	100																																																																																																																																																																																																																																																																										
	FR-BU2-H30K	—	—	260	180																																																																																																																																																																																																																																																																										

Brake unit
FR-BU2-(H)□□K

Resistor unit
FR-BR-(H)□□K

Discharging resistor
GZG type
GRZG type

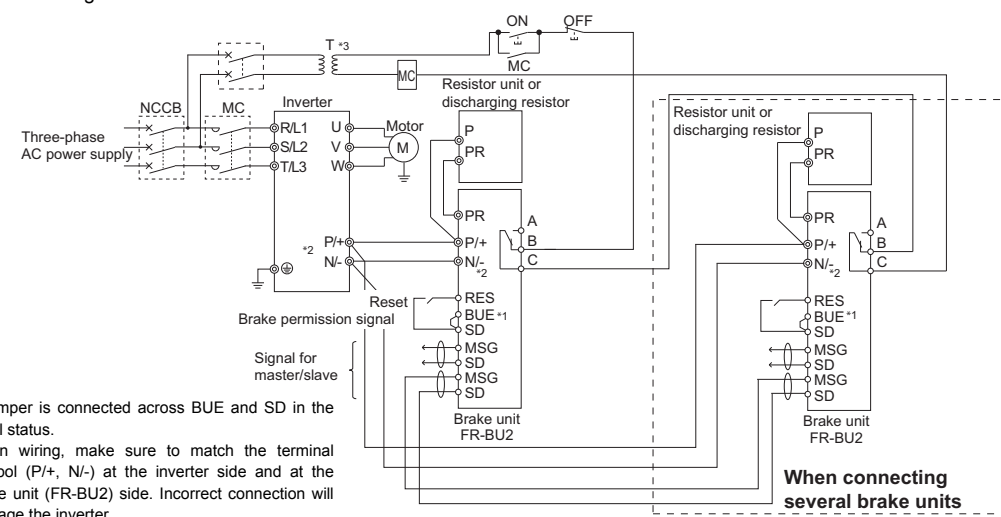
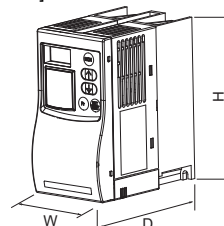
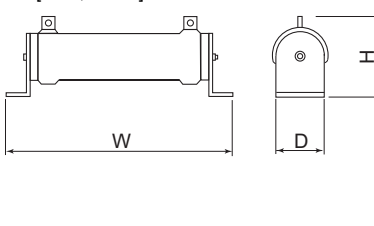
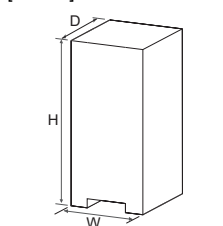

- Features
- Connection example
- Standard specs.
- Outline dimensions
- Terminal connection diagrams Terminal specs.
- Operation panel Parameter unit FR Configurator
- Parameter list
- Parameter descriptions
- Protective functions
- Options
- Precautions
- Motor
- IPM motor control
- Compatibility
- Warranty

Name (model)	Specification and Structure																																																																								
<p>Brake unit FR-BU2-(H)□□K</p> <p>Resistor unit FR-BR-(H)□□K</p> <p>Discharging resistor GZG type GRZG type</p> 	<p>● Connection diagram</p>  <p>*1 A jumper is connected across BUE and SD in the initial status.</p> <p>*2 When wiring, make sure to match the terminal symbol (P/+, N/-) at the inverter side and at the brake unit (FR-BU2) side. Incorrect connection will damage the inverter. Remove the jumper across the terminals P/+ and P1 only when a Filterpack or DC reactor is connected. Do not remove the jumper in other cases.</p> <p>*3 When the power supply is 400V class, install a step-down transformer.</p> <p>● Outline dimension</p> <div style="display: flex; justify-content: space-around;"> <div data-bbox="383 896 662 1153"> <p>[FR-BU2]</p>  </div> <div data-bbox="710 896 1101 1153"> <p>[GZG,GRZG]</p>  </div> <div data-bbox="1173 896 1412 1153"> <p>[FR-BR]</p>  </div> </div> <table border="1" style="width: 100%; text-align: center;"> <thead> <tr> <th colspan="4">(Unit mm)</th> <th colspan="4">(Unit mm)</th> <th colspan="4">(Unit mm)</th> </tr> <tr> <th>Model</th> <th>W</th> <th>H</th> <th>D</th> <th>Model</th> <th>W</th> <th>D</th> <th>H</th> <th>Model</th> <th>W</th> <th>H</th> <th>D</th> </tr> </thead> <tbody> <tr> <td>FR-BU2-1.5K to 15K</td> <td>68</td> <td>128</td> <td>132.5</td> <td>GZG300W</td> <td>335</td> <td>40</td> <td>78</td> <td>FR-BR-15K</td> <td>170</td> <td>450</td> <td>220</td> </tr> <tr> <td>FR-BU2-30K</td> <td>108</td> <td>128</td> <td>129.5</td> <td>GRZG200</td> <td>306</td> <td>26</td> <td>55</td> <td>FR-BR-30K</td> <td>340</td> <td>600</td> <td>220</td> </tr> <tr> <td>FR-BU2-H7.5K, H15K</td> <td>68</td> <td>128</td> <td>132.5</td> <td>GRZG300</td> <td>334</td> <td>40</td> <td>79</td> <td>FR-BR-H15K</td> <td>170</td> <td>450</td> <td>220</td> </tr> <tr> <td>FR-BU2-H30K</td> <td>108</td> <td>128</td> <td>129.5</td> <td>GRZG400</td> <td>411</td> <td>40</td> <td>79</td> <td>FR-BR-H30K</td> <td>340</td> <td>600</td> <td>220</td> </tr> </tbody> </table>	(Unit mm)				(Unit mm)				(Unit mm)				Model	W	H	D	Model	W	D	H	Model	W	H	D	FR-BU2-1.5K to 15K	68	128	132.5	GZG300W	335	40	78	FR-BR-15K	170	450	220	FR-BU2-30K	108	128	129.5	GRZG200	306	26	55	FR-BR-30K	340	600	220	FR-BU2-H7.5K, H15K	68	128	132.5	GRZG300	334	40	79	FR-BR-H15K	170	450	220	FR-BU2-H30K	108	128	129.5	GRZG400	411	40	79	FR-BR-H30K	340	600	220
(Unit mm)				(Unit mm)				(Unit mm)																																																																	
Model	W	H	D	Model	W	D	H	Model	W	H	D																																																														
FR-BU2-1.5K to 15K	68	128	132.5	GZG300W	335	40	78	FR-BR-15K	170	450	220																																																														
FR-BU2-30K	108	128	129.5	GRZG200	306	26	55	FR-BR-30K	340	600	220																																																														
FR-BU2-H7.5K, H15K	68	128	132.5	GRZG300	334	40	79	FR-BR-H15K	170	450	220																																																														
FR-BU2-H30K	108	128	129.5	GRZG400	411	40	79	FR-BR-H30K	340	600	220																																																														

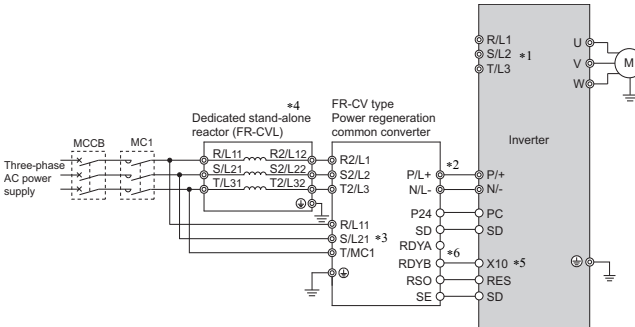
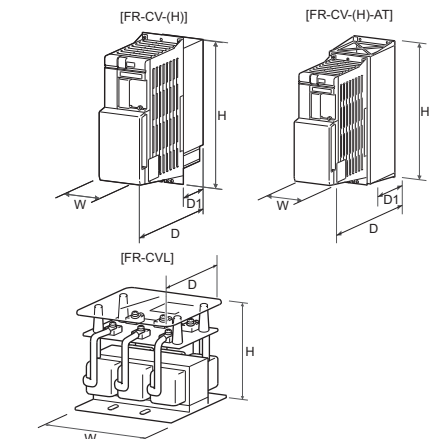
Name (model)	Specification and Structure																																																																																																																																																								
<p>Power regeneration common converter FR-CV-(H)□□K</p> 	<ul style="list-style-type: none"> Enables continuous regenerative operation at 100% torque. This option can support continuous regenerative operations including line operation. This converter eliminates the need of preparing brake units per inverter. This converter can cut down the total space and the cost. The regenerated energy is used by another inverter, and if there is still an excess, it is returned to the power supply, saving on the energy consumption. The exothermic section of the heatsink protrusion type protrudes from the back side of the enclosure to dissipate the heat generated from the converter to the outside of the enclosure. Connection diagram  <p>(Note) A Filterpack cannot be connected when FR-CV is connected.</p> <ul style="list-style-type: none"> Outline dimension  <table border="1"> <caption>FR-CV-(H) (unit mm)</caption> <thead> <tr> <th rowspan="2">Voltage/capacity</th> <th colspan="4">200V</th> <th colspan="4">400V</th> </tr> <tr> <th>W</th> <th>H</th> <th>D</th> <th>D1</th> <th>W</th> <th>H</th> <th>D</th> <th>D1</th> </tr> </thead> <tbody> <tr> <td>7.5K/11K</td> <td>90</td> <td>300</td> <td>303</td> <td>103</td> <td>120</td> <td>300</td> <td>305</td> <td>105</td> </tr> <tr> <td>15K</td> <td>120</td> <td>300</td> <td>305</td> <td>105</td> <td>150</td> <td>380</td> <td>305</td> <td>105</td> </tr> <tr> <td>22K/30K</td> <td>150</td> <td>380</td> <td>322</td> <td>122</td> <td>400</td> <td>620</td> <td>250</td> <td>135</td> </tr> <tr> <td>37K/55K</td> <td>400</td> <td>620</td> <td>250</td> <td>135</td> <td>400</td> <td>620</td> <td>250</td> <td>135</td> </tr> </tbody> </table> <table border="1"> <caption>FR-CV-(H)-AT (unit mm)</caption> <thead> <tr> <th rowspan="2">Voltage/capacity</th> <th colspan="4">200V</th> <th colspan="4">400V</th> </tr> <tr> <th>W</th> <th>H</th> <th>D</th> <th>D1</th> <th>W</th> <th>H</th> <th>D</th> <th>D1</th> </tr> </thead> <tbody> <tr> <td>7.5K/11K</td> <td>110</td> <td>330</td> <td>315</td> <td>115</td> <td>130</td> <td>330</td> <td>320</td> <td>120</td> </tr> <tr> <td>15K</td> <td>130</td> <td>330</td> <td>320</td> <td>120</td> <td>160</td> <td>410</td> <td>350</td> <td>150</td> </tr> <tr> <td>22K/30K</td> <td>160</td> <td>410</td> <td>350</td> <td>150</td> <td>160</td> <td>410</td> <td>350</td> <td>150</td> </tr> </tbody> </table> <table border="1"> <caption>FR-CV-L (unit mm)</caption> <thead> <tr> <th rowspan="2">Voltage/capacity</th> <th colspan="3">200V</th> <th colspan="3">400V</th> </tr> <tr> <th>W</th> <th>H</th> <th>D</th> <th>W</th> <th>H</th> <th>D</th> </tr> </thead> <tbody> <tr> <td>7.5K/11K/15K</td> <td>165</td> <td>155</td> <td>130</td> <td>220</td> <td>200</td> <td>135</td> </tr> <tr> <td>22K</td> <td>165</td> <td>155</td> <td>140</td> <td>220</td> <td>205</td> <td>135</td> </tr> <tr> <td>30K</td> <td>215</td> <td>175</td> <td>160</td> <td>220</td> <td>215</td> <td>150</td> </tr> <tr> <td>37K</td> <td>220</td> <td>200</td> <td>320</td> <td>245</td> <td>220</td> <td>185</td> </tr> <tr> <td>55K</td> <td>250</td> <td>225</td> <td>335</td> <td>245</td> <td>265</td> <td>230</td> </tr> <tr> <td></td> <td></td> <td></td> <td></td> <td>290</td> <td>280</td> <td>230</td> </tr> </tbody> </table> <p>*1 Do not connect anything to power input terminals (R/L1, S/L2, T/L3). Incorrect connection will damage the inverter. Connecting the opposite polarity of terminals N/- and P/+ will damage the inverter.</p> <p>*2 Do not insert an MCCB between the terminals P/+ and N/- (between terminals P/L+ and P/+ or between N/L- and N/-). Always match the terminal symbols (P/+, N/-) at the inverter side and at the power regeneration common converter side. Incorrect connection will damage the inverter. Do not remove the jumper across P/+ and P1.</p> <p>*3 Be sure to connect the power supply and terminals R/L11, S/L21, and T/MC1. Operating the inverter without connecting them will damage the power regeneration common converter.</p> <p>*4 Install the dedicated stand-alone reactor (FR-CVL) on a horizontal place.</p> <p>*5 Assign the terminal for X10, RES signal using any of Pr. 178 to Pr. 182 (input terminal function selection).</p> <p>*6 Always connect terminal RDYB of the FR-CV to an inverter terminal where the X10 signal or the MRS signal is assigned to. Always connect terminal SE of the FR-CV to the inverter terminal SD. Not connecting these terminals may damage the FR-CV.</p>	Voltage/capacity	200V				400V				W	H	D	D1	W	H	D	D1	7.5K/11K	90	300	303	103	120	300	305	105	15K	120	300	305	105	150	380	305	105	22K/30K	150	380	322	122	400	620	250	135	37K/55K	400	620	250	135	400	620	250	135	Voltage/capacity	200V				400V				W	H	D	D1	W	H	D	D1	7.5K/11K	110	330	315	115	130	330	320	120	15K	130	330	320	120	160	410	350	150	22K/30K	160	410	350	150	160	410	350	150	Voltage/capacity	200V			400V			W	H	D	W	H	D	7.5K/11K/15K	165	155	130	220	200	135	22K	165	155	140	220	205	135	30K	215	175	160	220	215	150	37K	220	200	320	245	220	185	55K	250	225	335	245	265	230					290	280	230
Voltage/capacity	200V				400V																																																																																																																																																				
	W	H	D	D1	W	H	D	D1																																																																																																																																																	
7.5K/11K	90	300	303	103	120	300	305	105																																																																																																																																																	
15K	120	300	305	105	150	380	305	105																																																																																																																																																	
22K/30K	150	380	322	122	400	620	250	135																																																																																																																																																	
37K/55K	400	620	250	135	400	620	250	135																																																																																																																																																	
Voltage/capacity	200V				400V																																																																																																																																																				
	W	H	D	D1	W	H	D	D1																																																																																																																																																	
7.5K/11K	110	330	315	115	130	330	320	120																																																																																																																																																	
15K	130	330	320	120	160	410	350	150																																																																																																																																																	
22K/30K	160	410	350	150	160	410	350	150																																																																																																																																																	
Voltage/capacity	200V			400V																																																																																																																																																					
	W	H	D	W	H	D																																																																																																																																																			
7.5K/11K/15K	165	155	130	220	200	135																																																																																																																																																			
22K	165	155	140	220	205	135																																																																																																																																																			
30K	215	175	160	220	215	150																																																																																																																																																			
37K	220	200	320	245	220	185																																																																																																																																																			
55K	250	225	335	245	265	230																																																																																																																																																			
				290	280	230																																																																																																																																																			

- Features
- Connection example
- Standard specs.
- Outline dimensions
- Terminal connection diagrams
- Terminal specs.
- Operation panel
- Parameter unit
- FR Configurator
- Parameter list
- Parameter descriptions
- Protective functions
- Options
- Precautions
- Motor
- IPM motor control
- Compatibility
- Warranty

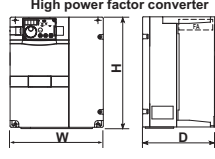
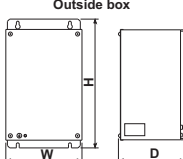
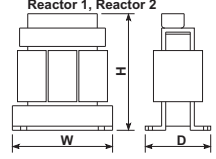
Name (model)	Specification and Structure																																																																																																																																																																																																																														
<p>High power factor converter FR-HC2-(H)□□K</p> 	<ul style="list-style-type: none"> Substantially suppresses power harmonics to realize the equivalent capacity conversion coefficient K5 = 0 in "the Harmonic Suppression Guidelines for Consumers Who Receive High Voltage or Special High Voltage" in Japan. The power regeneration function comes standard. The common converter driving with several inverters is possible. 																																																																																																																																																																																																																														
	<p>● Specification</p> <table border="1" style="width: 100%; border-collapse: collapse;"> <thead> <tr> <th rowspan="2">Model FR-HC2□□ (*2)</th> <th colspan="5">200V</th> <th colspan="10">400V</th> </tr> <tr> <th>7.5K</th> <th>15K</th> <th>30K</th> <th>55K</th> <th>75K</th> <th>H7.5K</th> <th>H15K</th> <th>H30K</th> <th>H55K</th> <th>H75K</th> <th>H110K</th> <th>H160K</th> <th>H220K</th> <th>H280K</th> <th>H400K</th> <th>H560K</th> </tr> </thead> <tbody> <tr> <td>Applicable inverter capacity (*1)</td> <td>3.7K to 7.5K</td> <td>7.5K to 15K</td> <td>15K to 30K</td> <td>30K to 55K</td> <td>37K to 75K</td> <td>3.7K to 7.5K</td> <td>7.5K to 15K</td> <td>15K to 30K</td> <td>30K to 55K</td> <td>37K to 75K</td> <td>55K to 110K</td> <td>90K to 160K</td> <td>110K to 220K</td> <td>160K to 280K</td> <td>200K to 400K</td> <td>280K to 560K</td> </tr> <tr> <td>Rated input voltage/frequency</td> <td colspan="5">Three-phase 200V to 220V 50Hz 200V to 230V 60Hz</td> <td colspan="10">Three-phase 380V to 460V 50/60Hz</td> </tr> <tr> <td>Rated input current (A)</td> <td>33</td> <td>61</td> <td>115</td> <td>215</td> <td>278</td> <td>17</td> <td>31</td> <td>57</td> <td>110</td> <td>139</td> <td>203</td> <td>290</td> <td>397</td> <td>506</td> <td>716</td> <td>993</td> </tr> </tbody> </table>															Model FR-HC2□□ (*2)	200V					400V										7.5K	15K	30K	55K	75K	H7.5K	H15K	H30K	H55K	H75K	H110K	H160K	H220K	H280K	H400K	H560K	Applicable inverter capacity (*1)	3.7K to 7.5K	7.5K to 15K	15K to 30K	30K to 55K	37K to 75K	3.7K to 7.5K	7.5K to 15K	15K to 30K	30K to 55K	37K to 75K	55K to 110K	90K to 160K	110K to 220K	160K to 280K	200K to 400K	280K to 560K	Rated input voltage/frequency	Three-phase 200V to 220V 50Hz 200V to 230V 60Hz					Three-phase 380V to 460V 50/60Hz										Rated input current (A)	33	61	115	215	278	17	31	57	110	139	203	290	397	506	716	993																																																																																																																														
	Model FR-HC2□□ (*2)	200V					400V																																																																																																																																																																																																																								
		7.5K	15K	30K	55K	75K	H7.5K	H15K	H30K	H55K	H75K	H110K	H160K	H220K	H280K	H400K	H560K																																																																																																																																																																																																														
	Applicable inverter capacity (*1)	3.7K to 7.5K	7.5K to 15K	15K to 30K	30K to 55K	37K to 75K	3.7K to 7.5K	7.5K to 15K	15K to 30K	30K to 55K	37K to 75K	55K to 110K	90K to 160K	110K to 220K	160K to 280K	200K to 400K	280K to 560K																																																																																																																																																																																																														
Rated input voltage/frequency	Three-phase 200V to 220V 50Hz 200V to 230V 60Hz					Three-phase 380V to 460V 50/60Hz																																																																																																																																																																																																																									
Rated input current (A)	33	61	115	215	278	17	31	57	110	139	203	290	397	506	716	993																																																																																																																																																																																																															
<p>*1 The total capacity of the connected inverters.</p> <p>*2 If a high power factor converter (FR-HC2) is purchased, it comes with reactor 1 (FR-HCL21), reactor 2 (FR-HCL22), and an outside box (FR-HCB2). (If an H280K or higher is purchased, it comes with FR-HCL21, FR-HCL22, FR-HCC2, FR-HCR2, and FR-HCM2.)</p>																																																																																																																																																																																																																															
<p>● Outline dimension (Unit mm)</p> <table border="1" style="width: 100%; border-collapse: collapse;"> <thead> <tr> <th rowspan="2">Voltage</th> <th rowspan="2">Capacity</th> <th colspan="3">High power factor converter FR-HC2</th> <th colspan="3">Reactor 1 FR-HCL21 (*1)</th> <th colspan="3">Reactor 2 FR-HCL22 (*1)</th> <th colspan="3">Outside box FR-HCB2 (*2)</th> </tr> <tr> <th>W</th> <th>H</th> <th>D</th> <th>W</th> <th>H</th> <th>D</th> <th>W</th> <th>H</th> <th>D</th> <th>W</th> <th>H</th> <th>D</th> </tr> </thead> <tbody> <tr> <td rowspan="5">200V</td> <td>7.5K</td> <td>220</td> <td>260</td> <td>170</td> <td>132</td> <td>150</td> <td>100</td> <td>237.5</td> <td>230</td> <td>140</td> <td rowspan="2">190</td> <td rowspan="2">320</td> <td rowspan="2">165</td> </tr> <tr> <td>15K</td> <td>250</td> <td>400</td> <td>190</td> <td>162</td> <td>172</td> <td>126</td> <td>257.5</td> <td>260</td> <td>165</td> </tr> <tr> <td>30K</td> <td>325</td> <td>550</td> <td>195</td> <td>195</td> <td>210</td> <td>150</td> <td>342.5</td> <td>305</td> <td>180</td> <td rowspan="3">270</td> <td rowspan="3">450</td> <td rowspan="3">203</td> </tr> <tr> <td>55K</td> <td>370</td> <td>620</td> <td>250</td> <td>210</td> <td>180</td> <td>200.5</td> <td>432.5</td> <td>380</td> <td>280</td> </tr> <tr> <td>75K</td> <td>465</td> <td>620</td> <td>300</td> <td>240</td> <td>215</td> <td>215.5</td> <td>474</td> <td>460</td> <td>280</td> </tr> <tr> <td rowspan="10">400V</td> <td>H7.5K</td> <td>220</td> <td>300</td> <td>190</td> <td>132</td> <td>140</td> <td>100</td> <td>237.5</td> <td>220</td> <td>140</td> <td rowspan="2">190</td> <td rowspan="2">320</td> <td rowspan="2">165</td> </tr> <tr> <td>H15K</td> <td>220</td> <td>300</td> <td>190</td> <td>162</td> <td>170</td> <td>126</td> <td>257.5</td> <td>260</td> <td>165</td> </tr> <tr> <td>H30K</td> <td>325</td> <td>550</td> <td>195</td> <td>182</td> <td>195</td> <td>101</td> <td>342.5</td> <td>300</td> <td>180</td> <td rowspan="3">270</td> <td rowspan="3">450</td> <td rowspan="3">203</td> </tr> <tr> <td>H55K</td> <td>370</td> <td>670</td> <td>250</td> <td>282.5</td> <td>245</td> <td>165</td> <td>392.5</td> <td>365</td> <td>200</td> </tr> <tr> <td>H75K</td> <td>325</td> <td>620</td> <td>250</td> <td>210</td> <td>175</td> <td>210.5</td> <td>430</td> <td>395</td> <td>280</td> </tr> <tr> <td>H110K</td> <td>465</td> <td>620</td> <td>300</td> <td>240</td> <td>230</td> <td>220</td> <td>500</td> <td>440</td> <td>370</td> <td rowspan="2">350</td> <td rowspan="2">450</td> <td rowspan="2">380</td> </tr> <tr> <td>H160K</td> <td>498</td> <td>1010</td> <td>380</td> <td>280</td> <td>295</td> <td>274.5</td> <td>560</td> <td>520</td> <td>430</td> </tr> <tr> <td>H220K</td> <td>498</td> <td>1010</td> <td>380</td> <td>330</td> <td>335</td> <td>289.5</td> <td>620</td> <td>620</td> <td>480</td> <td rowspan="3">400</td> <td rowspan="3">450</td> <td rowspan="3">440</td> </tr> <tr> <td>H280K</td> <td>680</td> <td>1010</td> <td>380</td> <td>330</td> <td>335</td> <td>321</td> <td>690</td> <td>700</td> <td>560</td> </tr> <tr> <td>H400K</td> <td>790</td> <td>1330</td> <td>440</td> <td>402</td> <td>460</td> <td>550</td> <td>632</td> <td>675</td> <td>705</td> </tr> <tr> <td>H560K</td> <td>790</td> <td>1330</td> <td>440</td> <td>452</td> <td>545</td> <td>645</td> <td>632</td> <td>720</td> <td>745</td> <td>—</td> <td>—</td> <td>—</td> </tr> </tbody> </table>															Voltage	Capacity	High power factor converter FR-HC2			Reactor 1 FR-HCL21 (*1)			Reactor 2 FR-HCL22 (*1)			Outside box FR-HCB2 (*2)			W	H	D	W	H	D	W	H	D	W	H	D	200V	7.5K	220	260	170	132	150	100	237.5	230	140	190	320	165	15K	250	400	190	162	172	126	257.5	260	165	30K	325	550	195	195	210	150	342.5	305	180	270	450	203	55K	370	620	250	210	180	200.5	432.5	380	280	75K	465	620	300	240	215	215.5	474	460	280	400V	H7.5K	220	300	190	132	140	100	237.5	220	140	190	320	165	H15K	220	300	190	162	170	126	257.5	260	165	H30K	325	550	195	182	195	101	342.5	300	180	270	450	203	H55K	370	670	250	282.5	245	165	392.5	365	200	H75K	325	620	250	210	175	210.5	430	395	280	H110K	465	620	300	240	230	220	500	440	370	350	450	380	H160K	498	1010	380	280	295	274.5	560	520	430	H220K	498	1010	380	330	335	289.5	620	620	480	400	450	440	H280K	680	1010	380	330	335	321	690	700	560	H400K	790	1330	440	402	460	550	632	675	705	H560K	790	1330	440	452	545	645	632	720	745	—	—	—
Voltage	Capacity	High power factor converter FR-HC2			Reactor 1 FR-HCL21 (*1)			Reactor 2 FR-HCL22 (*1)			Outside box FR-HCB2 (*2)																																																																																																																																																																																																																				
		W	H	D	W	H	D	W	H	D	W	H	D																																																																																																																																																																																																																		
200V	7.5K	220	260	170	132	150	100	237.5	230	140	190	320	165																																																																																																																																																																																																																		
	15K	250	400	190	162	172	126	257.5	260	165																																																																																																																																																																																																																					
	30K	325	550	195	195	210	150	342.5	305	180	270	450	203																																																																																																																																																																																																																		
	55K	370	620	250	210	180	200.5	432.5	380	280																																																																																																																																																																																																																					
	75K	465	620	300	240	215	215.5	474	460	280																																																																																																																																																																																																																					
400V	H7.5K	220	300	190	132	140	100	237.5	220	140	190	320	165																																																																																																																																																																																																																		
	H15K	220	300	190	162	170	126	257.5	260	165																																																																																																																																																																																																																					
	H30K	325	550	195	182	195	101	342.5	300	180	270	450	203																																																																																																																																																																																																																		
	H55K	370	670	250	282.5	245	165	392.5	365	200																																																																																																																																																																																																																					
	H75K	325	620	250	210	175	210.5	430	395	280																																																																																																																																																																																																																					
	H110K	465	620	300	240	230	220	500	440	370	350	450	380																																																																																																																																																																																																																		
	H160K	498	1010	380	280	295	274.5	560	520	430																																																																																																																																																																																																																					
	H220K	498	1010	380	330	335	289.5	620	620	480	400	450	440																																																																																																																																																																																																																		
	H280K	680	1010	380	330	335	321	690	700	560																																																																																																																																																																																																																					
	H400K	790	1330	440	402	460	550	632	675	705																																																																																																																																																																																																																					
H560K	790	1330	440	452	545	645	632	720	745	—	—	—																																																																																																																																																																																																																			
<div style="display: flex; justify-content: space-around;"> <div style="text-align: center;"> <p>High power factor converter</p>  </div> <div style="text-align: center;"> <p>Outside box</p>  </div> <div style="text-align: center;"> <p>Reactor 1, Reactor 2</p>  </div> </div> <p>*1 Install reactors (FR-HCL21 and 22) on a horizontal surface.</p> <p>*2 FR-HCB2 is not provided for H280K or higher. A filter capacitor and inrush current limit resistors are provided instead.</p>																																																																																																																																																																																																																															

Name (model)	Specification and Structure																																																																																
	<ul style="list-style-type: none"> Limits surge voltage applied to motor terminals when driving a 400V class motor with an inverter (available only with general-purpose motors). Supports FR-F740PJ-5.5K to 37K. 																																																																																
	<ul style="list-style-type: none"> ● Specification 																																																																																
	<table border="1"> <tr> <td>Model FR-BMF-H□□K</td> <td colspan="2">7.5</td> <td colspan="2">15</td> </tr> <tr> <td>Applicable motor capacity (kW) *1</td> <td>5.5</td> <td>7.5</td> <td>11</td> <td>15</td> </tr> <tr> <td>Rated current (A)</td> <td colspan="2">17</td> <td colspan="2">31</td> </tr> <tr> <td>Overload current rating*2</td> <td colspan="4">150 60s 200 0.5s (inverse-time characteristics)</td> </tr> <tr> <td>Rated input AC voltage*2</td> <td colspan="4">Three-phase 380 to 480V</td> </tr> <tr> <td>Permissible AC voltage fluctuation*2</td> <td colspan="4">323 to 528V</td> </tr> <tr> <td>Maximum frequency*2</td> <td colspan="4">120Hz</td> </tr> <tr> <td>PWM carrier frequency</td> <td colspan="4">2kHz or less *3</td> </tr> <tr> <td>Protective structure (JEM 1030)</td> <td colspan="4">Open type (IP00)</td> </tr> <tr> <td>Cooling system</td> <td colspan="4">Self-cooling</td> </tr> <tr> <td>Maximum wiring length</td> <td colspan="4">100m or shorter</td> </tr> <tr> <td>Approx. mass (kg)</td> <td colspan="2">5.5</td> <td colspan="2">9.5</td> </tr> <tr> <td rowspan="4" style="writing-mode: vertical-rl; transform: rotate(180deg);">Environment</td> <td>Surrounding air temperature</td> <td colspan="3">-10°C to +50°C (non-freezing)</td> </tr> <tr> <td>Ambient humidity</td> <td colspan="3">90% RH or less (non-condensing)</td> </tr> <tr> <td>Atmosphere</td> <td colspan="3">Indoors (free from corrosive gas, flammable gas, oil mist, dust and dirt)</td> </tr> <tr> <td>Altitude/vibration</td> <td colspan="3">Maximum 1000m above sea level, 5.9m/s² or less*4 at 10 to 55Hz (directions of X, Y, Z axes)</td> </tr> </table>				Model FR-BMF-H□□K	7.5		15		Applicable motor capacity (kW) *1	5.5	7.5	11	15	Rated current (A)	17		31		Overload current rating*2	150 60s 200 0.5s (inverse-time characteristics)				Rated input AC voltage*2	Three-phase 380 to 480V				Permissible AC voltage fluctuation*2	323 to 528V				Maximum frequency*2	120Hz				PWM carrier frequency	2kHz or less *3				Protective structure (JEM 1030)	Open type (IP00)				Cooling system	Self-cooling				Maximum wiring length	100m or shorter				Approx. mass (kg)	5.5		9.5		Environment	Surrounding air temperature	-10°C to +50°C (non-freezing)			Ambient humidity	90% RH or less (non-condensing)			Atmosphere	Indoors (free from corrosive gas, flammable gas, oil mist, dust and dirt)			Altitude/vibration	Maximum 1000m above sea level, 5.9m/s ² or less*4 at 10 to 55Hz (directions of X, Y, Z axes)		
Model FR-BMF-H□□K	7.5		15																																																																														
Applicable motor capacity (kW) *1	5.5	7.5	11	15																																																																													
Rated current (A)	17		31																																																																														
Overload current rating*2	150 60s 200 0.5s (inverse-time characteristics)																																																																																
Rated input AC voltage*2	Three-phase 380 to 480V																																																																																
Permissible AC voltage fluctuation*2	323 to 528V																																																																																
Maximum frequency*2	120Hz																																																																																
PWM carrier frequency	2kHz or less *3																																																																																
Protective structure (JEM 1030)	Open type (IP00)																																																																																
Cooling system	Self-cooling																																																																																
Maximum wiring length	100m or shorter																																																																																
Approx. mass (kg)	5.5		9.5																																																																														
Environment	Surrounding air temperature	-10°C to +50°C (non-freezing)																																																																															
	Ambient humidity	90% RH or less (non-condensing)																																																																															
	Atmosphere	Indoors (free from corrosive gas, flammable gas, oil mist, dust and dirt)																																																																															
	Altitude/vibration	Maximum 1000m above sea level, 5.9m/s ² or less*4 at 10 to 55Hz (directions of X, Y, Z axes)																																																																															
	<ul style="list-style-type: none"> ● Connection diagram 																																																																																
	<p>* Install a stepdown transformer.</p>																																																																																
	<ul style="list-style-type: none"> ● Outline dimension 																																																																																
	<div style="display: flex; justify-content: space-around;"> <div style="width: 45%;"> <p>● FR-BMF-H7.5K</p> </div> <div style="width: 45%;"> <p>● FR-BMF-H15K</p> </div> </div> <p style="text-align: right;">(Unit: mm)</p>																																																																																
<p>Surge voltage suppression filter FR-BMF-H□□K</p>																																																																																	

Surge voltage suppression filter
FR-BMF-H□□K

- Features
- Connection example
- Standard specs.
- Outline dimensions
- Terminal connection diagrams
Terminal specs.
- Operation panel
Parameter unit
FR Configurator
- Parameter list
- Parameter descriptions
- Protective functions
- Options
- Precautions
- Motor
- IPM motor control
- Compatibility
- Warranty

**Moulded Case Circuit Breaker (MCCB), Earth Leakage Circuit Breaker (ELB),
Input Side Magnetic Contactor, Cable size**

Voltage	Applicable Inverter Model	Motor Output (kW)	Moulded Case Circuit Breaker (MCCB)*1 or Earth Leakage Circuit Breaker (ELB)*2 (NF or NV type)		Input Side Magnetic Contactor*3		Recommended cable gauge*4	
			Power factor improving (AC or DC) reactor		Power factor improving (AC or DC) reactor		R/L1, S/L2, T/L3	U, V, W
			Without	With	Without	With		
Three-phase 200V class	FR-F720PJ-0.4K	0.4	5A	5A	S-N10	S-N10	2	2
	FR-F720PJ-0.75K	0.75	10A	5A	S-N10	S-N10	2	2
	FR-F720PJ-1.5K	1.5	15A	10A	S-N10	S-N10	2	2
	FR-F720PJ-2.2K	2.2	20A	15A	S-N10	S-N10	2	2
	FR-F720PJ-3.7K	3.7	30A	30A	S-N20, S-N21	S-N10	3.5	3.5
	FR-F720PJ-5.5K	5.5	50A	40A	S-N20, S-N21	S-N20, S-N21	5.5	5.5
	FR-F720PJ-7.5K	7.5	60A	50A	S-N25	S-N20, S-N21	14	8
	FR-F720PJ-11K	11	75A	75A	S-N35	S-N35	14	14
Three-phase 400V class	FR-F740PJ-0.4K	0.4	5A	5A	S-N10	S-N10	2	2
	FR-F740PJ-0.75K	0.75	5A	5A	S-N10	S-N10	2	2
	FR-F740PJ-1.5K	1.5	10A	10A	S-N10	S-N10	2	2
	FR-F740PJ-2.2K	2.2	15A	10A	S-N10	S-N10	2	2
	FR-F740PJ-3.7K	3.7	20A	15A	S-N10	S-N10	2	2
	FR-F740PJ-5.5K	5.5	30A	20A	S-N20, S-N21	S-N11, S-N12	3.5	2
	FR-F740PJ-7.5K	7.5	30A	30A	S-N20, S-N21	S-N20, S-N21	3.5	3.5
	FR-F740PJ-11K	11	50A	40A	S-N20, S-N21	S-N20, S-N21	5.5	5.5
FR-F740PJ-15K	15	60A	50A	S-N25	S-N20, S-N21	8	8	

- *1 Select an MCCB model according to the power supply capacity.
- *2 Install one MCCB per inverter.

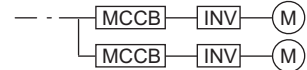

- *2 For the use in the United States or Canada, select a UL and cUL certified fuse with Class T fuse equivalent cut-off speed or faster with the appropriate rating for branch circuit protection. Alternatively, select a UL489 molded case circuit breaker (MCCB).
- *3 Magnetic contactor is selected based on the AC-1 class. The electrical durability of magnetic contactor is 500,000 times. When the magnetic contactor is used for emergency stop during motor driving, the electrical durability is 25 times.
If using an MC for emergency stop during motor driving, select an MC regarding the inverter input side current as JEM1038-AC-3 class rated current. When using an MC on the inverter output side for commercial-power supply operation switching using a general purpose motor, select an MC regarding the motor rated current as JEM1038-AC-3 class rated current.
- *4 The recommended cable gauge is that of the cable (e.g. HIV cable (600V class 2 vinyl-insulated cable)) with continuous maximum permissible temperature of 75°C. Assumes that the surrounding air temperature is 50°C or less and the wiring distance is 20m or less.



NOTE

- When the inverter capacity is larger than the motor capacity during the general-purpose motor operation, select an MCCB and a magnetic contactor according to the inverter model, and select cable and reactor according to the motor output.
- When the breaker on the inverter primary side trips, check for the wiring fault (short circuit), damage to internal parts of the inverter, etc. Identify the cause of the trip, then remove the cause and power ON the breaker.

Selection of rated sensitivity current of earth leakage circuit breaker

When using the earth leakage current breaker with the inverter circuit, select its rated sensitivity current as follows, independently of the PWM carrier frequency:

- Breaker designed for harmonic and surge suppression
Rated sensitivity current:
 $I_{\Delta n} \geq 10 \times (I_{g1} + I_{gn} + I_{gi} + I_{g2} + I_{gm})$
- Standard breaker
Rated sensitivity current:
 $I_{\Delta n} \geq 10 \times \{I_{g1} + I_{gn} + I_{gi} + 3 \times (I_{g2} + I_{gm})\}$
I_{g1}, I_{g2} : Leakage currents in wire path during commercial power supply operation
I_{gn} : Leakage current of inverter input side noise filter
I_{gm} : Leakage current of motor during commercial power supply operation
I_{gi} : Leakage current of inverter unit

Example of leakage current of cable path per 1km during the commercial power supply operation when the CV cable is routed in metal conduit (200V 60Hz)

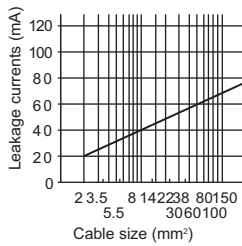

Leakage current example of three-phase induction motor during the commercial power supply operation (200V 60Hz)

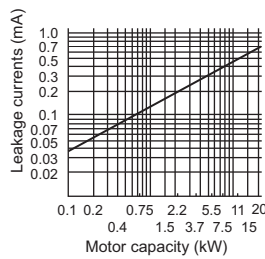

Example of leakage current per 1km during the commercial power supply operation when the CV cable is routed in metal conduit (Three-phase three-wire delta connection 400V/60Hz)

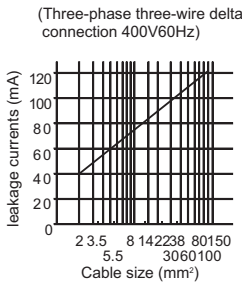

Leakage current example of three-phase induction motor during the commercial power supply operation (Totally-enclosed fan-cooled type motor 400V/60Hz)

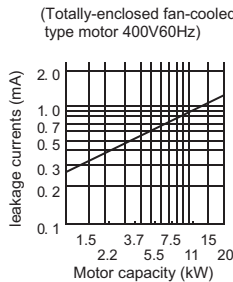

For "Δ" connection, the amount of leakage current is approx. 1/3 of the above value.

Example

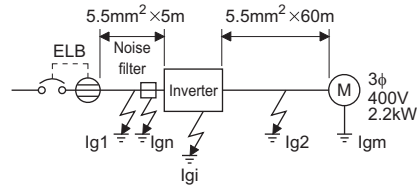

- (Note) 1. Install the earth leakage circuit breaker (ELB) on the input side of the inverter.
2. In the Δ connection earthed-neutral system, the sensitivity current is blunt against an earth (ground) fault in the inverter output side. Earthing (Grounding) must conform to the requirements of national and local safety regulations and electrical codes. (NEC section 250, IEC 536 class 1 and other applicable standards)

- Selection example (in the case of the left figure (400V class Δ connection))

	Breaker Designed for Harmonic and Surge Suppression	Standard Breaker
Leakage current I _{g1} (mA)	$\frac{1}{3} \times 66 \times \frac{5m}{1000m} = 0.11$	
Leakage current I _{gn} (mA)	0 (Without a noise filter or Filterpack)	
Leakage current I _{gi} (mA)	1	
Leakage current I _{g2} (mA)	$\frac{1}{3} \times 66 \times \frac{60m}{1000m} = 1.32$	
Motor leakage current I _{gm} (mA)	0.36	
Total leakage current (mA)	2.79	6.15
Rated sensitivity current (mA) (≥ I _g × 10)	30	100

- Features
- Connection example
- Standard specs.
- Outline dimensions
- Terminal connection diagrams
- Terminal specs.
- Operation panel
- Parameter unit
- FR Configurator
- Parameter list
- Parameter descriptions
- Protective functions
- Options
- Precautions
- Motor
- IPM motor control
- Compatibility
- Warranty

Precautions for use of the inverter

⚠ Safety Precautions

- To operate the inverter correctly and safely, be sure to read the "instruction manual" before starting operation.
- This product has not been designed or manufactured for use with any equipment or system operated under life-threatening conditions.
- Please contact our sales office when you are considering using this product in special applications such as passenger mobile, medical, aerospace, nuclear, power or undersea relay equipment or system.
- Although this product is manufactured under strict quality control, safety devices should be installed when a serious accident or loss is expected by a failure of this product.
- Do not use the F700P inverter with a load other than a three-phase induction motor or a dedicated IPM motor.
- Do not connect an IPM motor under the general-purpose motor control settings (initial settings). Do not use a general-purpose motor in the IPM motor control settings. Doing so will cause a failure.
When using a dedicated IPM motor, *the precautions for the use of the dedicated IPM motor* must be observed as well.

● Operation

- A magnetic contactor (MC) provided on the primary side should not be used to make frequent starts and stops. It could cause the inverter to fail.
- However, at this time, the motor cannot be brought to a sudden stop. Hence, provide a mechanical stopping/holding mechanism for the machine/equipment which requires an emergency stop.
- It will take time for the capacitor to discharge after shutoff of the inverter power supply. When accessing the inverter for inspection, wait for at least 10 minutes after the power supply has been switched off, and check to make sure that there are no residual voltage using a tester or the like.

● Wiring

- Application of power to the output terminals (U, V, W) of the inverter will damage the inverter. Therefore, fully check the wiring and sequence to ensure that wiring is correct, etc. before powering ON.
- The terminals P/+, PR, P1, N/- are provided for connection of a dedicated option. Connect only a dedicated option. Do not short the frequency setting power supply terminal 10 and common terminal 5 or the terminal PC and terminal SD.
- When disconnecting a wire from a control circuit terminal, push the open/close button all the way down with a flathead screwdriver, and pull out the wire. Pulling out the wire forcefully without pushing the open/close button all the way down may damage the terminal block.

● Power supply

- When the inverter is connected near a large-capacity power transformer (500kVA or more) or when a power capacitor is to be switched over, an excessive peak current may flow in the power input circuit, damaging the converter circuit.

If this is the case, always install a Filterpack or optional AC reactor (FR-HAL).

- If a surge voltage occurs in the power supply system, this surge energy may flow into the inverter, causing the inverter to display overvoltage protection (E.OV□).
If this is the case, install a Filterpack or optional AC reactor (FR-HAL).

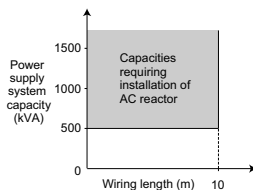

● Installation

- Avoid hostile environment where oil mist, fluff, dust particles, etc. are suspended in the air, and install the inverter in a clean place or put it in an ingress-protected "enclosed" enclosure. When placing the inverter in an enclosure, determine the cooling system and enclosure dimensions so that the ambient temperature of the inverter is within the permissible value. (refer to *page 8* for the specified value)
- Do not install the inverter on wood or other combustible material as it will be hot locally.
- Install the inverter in the vertical orientation.

● Setting

- The inverter can be operated as fast as a maximum of 400Hz by parameter setting. Therefore, incorrect setting can cause a danger. Set the upper limit using the maximum frequency limit setting function.
- A setting higher than the initial value of DC injection brake operation voltage or operation time can cause motor overheat (electronic thermal relay trip).
- Do not set *Pr.70 Special regenerative brake duty* except for using an optional brake resistor. Note that this function is used for over heat protection of brake resistors. Take caution not to set a value that exceeds the permissible brake resistor duty in this parameter.

Precautions for the use of a dedicated IPM motor

When using the dedicated IPM motor (MM-EFS, MM-EF), the following precautions must be observed as well.

⚠ SAFETY INSTRUCTIONS

- Do not use an IPM motor for an application where the motor is driven by the load and runs at a speed higher than the maximum motor speed.

● Combination of Motor and Inverter

- Use the same dedicated IPM motor capacity as the inverter capacity.
- Only one IPM motor can be connected to an inverter.
- A dedicated IPM motor cannot be driven by the commercial power supply.
- Do not use a synchronized or induction-synchronized motor, that is not a dedicated IPM motor.

● Installation

- While power is ON or for some time after power-OFF, do not touch the motor since the motor will be extremely hot. Touching these devices may cause a burn.
- The outline dimensions of MM-EF motors and standard motors are different. (It is the same for MM-EFS and the standard motors.)
[Rated speed 1800r/min specification]

Output (kW)	Frame number		
	IPM motor		Standard motor
	MM-EF 1800r/min spec.	MM-EFS 1500r/min spec.	SF-JR4P
0.4	80M	—	71M
0.75		80M	
1.5	90L	90L	
2.2		100L	
3.7	100L	112M	
5.5	112M	132S	
7.5		132M	
11	132S	160M	
15		160L	

- The following table indicates the available installation orientations.

	Frame number		80M to 160L
	Simplified diagram		
Floor installation *1	Terminal direction		○
Wall installation *2	Shaft going up		△
	Shaft horizontal		○
	Shaft going down		○
Ceiling installation	Ceiling installation		○

- Standard models can be installed as they are.
- △ Dedicated models are required.
- × Not available as installation strength is insufficient.

- *1 The floor installation condition is applicable to a slope of up to 30°. If the slope is steeper, apply the wall installation condition.
- *2 To install a horizontal motor to a wall, first attach a shelf that supports the motor legs.

● Wiring

- Applying the commercial power supply to input terminals (U, V, W) of an IPM motor will burn the IPM motor. The IPM motor must be connected with the output terminals (U, V, W) of the inverter.
- An IPM motor is a motor with interior permanent magnets. High voltage is generated at motor terminals while the motor is running. Before wiring or inspection, the motor must be confirmed to be stopped. In an application, such as fan and blower, where the motor is driven by the load, a low-voltage manual contactor must be connected at the inverter's output side, and wiring and inspection must be performed while the contactor is open. Otherwise you may get an electric shock. The inverter power must be turned ON before closing the contacts of the contactor at the output side.
- Match the input terminals (U, V, W) of the motor and the output terminals (U, V, W) of the inverter when connecting.
- Use the following length of wiring or shorter when connecting an IPM motor.

Pr.72 PWM frequency selection Setting (carrier frequency)	400V class 0.4K	200V class 0.4K or higher 400V class 0.75K or higher
4 (2.5kHz) or less	50m	100m
5 (5kHz) or higher		30m

Use one dedicated IPM motor for one inverter.
Multiple IPM motors cannot be connected to an inverter.

● Operation

- It takes approx. 0.1s (magnetic pole detection time) to start a motor after a start signal is input.
- An IPM motor is a motor with interior permanent magnets. Regressive voltage is generated when the motor coasts at an instantaneous power failure or at a flying start. The inverter's DC bus voltage rises if the motor coasts fast or make a flying start in this condition. When using the automatic restart after instantaneous power failure function, it is recommended to also use the regenerative avoidance operation to start up smoothly.
- The number of poles of the dedicated IPM motor is six. The relationship between the speed and frequency setting is calculated as:

$$\text{Speed} = 120 \times \frac{\text{Frequency setting}}{6P}$$

Speed [r/min]	300	600	900	1200	1500	1800	2250	2400	2700
Frequency setting [Hz]	15	30	45	60	75	90	112.5	120*	135*

- * The maximum speed of MM-EFS is 2250r/min.

Features

Connection example

Standard specs.

Outline dimensions

Terminal connection diagrams
Terminal specs.

Operation panel
Parameter unit
FR Configurator

Parameter list

Parameter descriptions

Protective functions

Options

Precautions

Motor

IPM motor control

Compatibility

Warranty

● Connection with machine

Direct connection

- When installing, align the motor shaft center and the machine shaft. Insert a liner underneath the motor or the machine legs as required to make a perfect alignment.

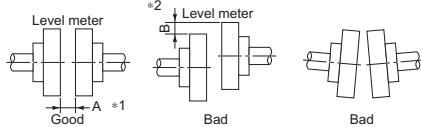

- *1 Use a feeler gauge to check the gaps in a few places, and make sure that all the gap sizes are the same (3/100mm or less difference except the gap A).
- *2 Unevenness shown in B is unacceptable (3/100mm or smaller difference)



NOTE

- When a fan or blower is directly connected to the motor shaft or to the machine, the machine side may become unbalanced. When the unbalanced degree becomes larger, the motor vibration becomes larger and may result in a damage of the bearing or other area. The balance quality with the machine should meet the class G2.5 or lower of JISB0905 (the Balance Quality Requirements of Rigid Rotors).

Connected by belt

- When installing, place the motor shaft and the machine shaft in parallel, and mount them to a position where their pulley centers are aligned. Their pulley centers should also have a right angle to each shaft.
- An excessively stretched belt may damage the bearing and break the shafts. A loose belt may slip off and easily deteriorate. A flat belt should be rotated lightly when it is pulled by one hand. For details, refer to the Instruction Manual of the motor.

Connected by gear couplings

- Place the motor and machine shafts in parallel, and engage the gear teeth properly.

● Permissible vibration of the motor

- Bearing is subjected to fretting while the motor is stopped. Suppress the vibration to about the half of the permissible value. Amplitude at each vibration condition is as shown right.

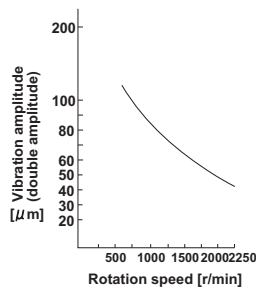

● Permissible load of the shaft

MM-EFSC□1M(4)	7	15	22	37	55	75	11K	15K
L [mm] *1	40	50	60	80	80	110		
Permissible radial load [N] *2	535	585	830	1070	1710	2150		
Permissible thrust load [N] *2	470	500	695	900	1420	1810		

- *1 For the symbols used in the table, refer to the diagram at right.
- *2 The permissible radial load and the permissible thrust load are the permissible values when they are applied individually.

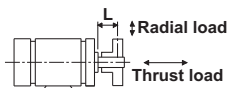

Precautions for selection

● Inverter capacity selection

- When operating a special motor or more than one motor in parallel with a single inverter, select the inverter capacity so that 1.1 times the total rated motor current is less than the rated output current of the inverter.
- * Multiple IPM motors cannot be connected to an inverter.

● Starting torque of the motor

- The start and acceleration characteristics of the motor driven by the inverter are restricted by the overload current rating of that inverter. Generally the torque characteristic is less than when the motor is started by a commercial power supply. When torque boost adjustment or simple magnetic flux vector cannot provide enough starting torque, select the inverter of one rank higher capacity or increase the capacities of both the motor and inverter.

● Acceleration and deceleration times

- The acceleration/deceleration time of the motor depends on the motor-generated torque, load torque and moment of inertia of the load (GD^2).
- When the stall prevention function is activated during acceleration/deceleration, increase the acceleration/deceleration time as the actual time may become longer.
- When shorter acceleration/deceleration time is required, increase the torque boost value (setting too large value may cause activation of the stall prevention function, resulting in longer acceleration time), apply General-purpose magnetic flux control, or increase the motor capacity. To shorten the deceleration time, additional use of options such as a brake resistor (MRS type, MYS type or FR-ABR), brake unit (FR-BU2) to absorb the braking energy, or power regeneration common converter (FR-CV) is required.

● Power transfer mechanism

(gear, belt, chain, etc.)

- When an oil-lubricated gear box, speed change gear or similar device is used in the power transfer system, note that continuous operation at low decelerated speed only may deteriorate oil lubrication, causing seizure. When performing fast operation at higher than 60Hz, fully note that such operation will cause strength shortage due to the noise, life or centrifugal force of the power transfer mechanism.

● Instructions for overload operation

- When performing operation of frequent start/stop of the inverter, rise/fall in the temperature of the transistor element of the inverter will repeat due to a continuous flow of large current, shortening the life from thermal fatigue. Since thermal fatigue is related to the amount of current, the life can be increased by reducing bound current, starting current, etc. Since thermal fatigue is related to the amount of current, the life can be increased by reducing current. However, decreasing current will result in insufficient torque and the inverter may not start. A counter action for this to raise the permissible current level by increasing the inverter capacity when using a general-purpose motor, and by increasing the inverter and IPM capacities when using an IPM motor.

● Installation and selection of molded case circuit breaker

Install a molded case circuit breaker (MCCB) on the power receiving side to protect the wiring of the inverter primary side. For MCCB selection, refer to *page 65* since it depends on the inverter power supply side power factor (which changes depending on the power supply voltage, output frequency and load). Note that the operation characteristics of the completely electromagnetic MCCB changes according to the higher harmonic current, so a larger capacity must be selected. (Check it in the data of the corresponding breaker.) As an earth (ground) leakage breaker, use the Mitsubishi earth (ground) leakage breaker designed for harmonics and surges. (*Refer to page 66.*) When installing a molded case circuit breaker on the secondary side of the inverter, contact each manufacturer for selection of the molded case circuit breaker.

● Handling of primary side magnetic contactor

- For operation via external terminal (terminal STF or STR used), provide a primary side MC to prevent an accident caused by a natural restart at power recovery after a power failure, such as an instantaneous power failure, and to ensure safety for maintenance work. Do not use this magnetic contactor to make frequent starts and stops. (The switching life of the inverter input circuit is about 1,000,000 times.) For parameter unit operation, an automatic restart after power failure is not made and the MC cannot be used to make a start. Note that the primary side MC can stop the operation, but the regenerative brake specific to the inverter does not operate and the motor coasts to stop.
- Installation of a magnetic contactor at the input side is recommended. A magnetic contactor avoids overheat or burnout of a brake resistor when heat capacity of the resistor is insufficient or a brake regenerative transistor is damaged with short while connecting an optional brake resistor. In this regard, shut off the power with the magnetic contactor, for example, when an inverter fault occurs due to an abnormal output.

● Handling of secondary side magnetic contactor

Switch the magnetic contactor between the inverter and motor only when both the inverter and motor are at a stop. When the magnetic contactor is turned on while the inverter is operating, overcurrent protection of the inverter and such will activate. When providing MCs to use the commercial power supply, switch the MCs after both the inverter and motor stop.

* An IPM motor cannot be driven by the commercial power supply.

● Thermal relay installation

The inverter has an electronic thermal relay function to protect the motor from overheating. However, when running multiple motors with one inverter or operating a multi-pole motor, provide a thermal relay (OCR) between the inverter and motor. In this case, set the electronic thermal relay function of the inverter to 0A. And for the setting of the thermal relay, add the line-to-line leakage current (*Refer to page 71*) to the current value on the motor rating plate.

Self cooling ability of a motor reduces at low speed operation. A motor with built-in thermistor is recommended.

* Multiple IPM motors cannot be connected to an inverter.

● Secondary side measuring instrument

When the wiring length between the inverter and motor is long, select the device that has enough current rating.

Otherwise the measuring instrument or CT which is used especially for the 400V class small-capacity inverter may generate heat due to the influence of line leakage current.

● Disuse of power factor improving capacitor (power capacitor)

The power factor improving capacitor and surge suppressor on the inverter output side may be overheated or damaged by the harmonic components of the inverter output. Also, since an excessive current flows in the inverter to activate overcurrent protection, do not install a capacitor or surge suppressor. To improve the power factor, use a DC reactor (details in *page 57*) or Filterpack.

● Electromagnetic wave interference

The input/output of the inverter main circuit (power circuit) includes high harmonic components, which may interfere with the communication devices (such as AM radios) or sensors used near the inverter. In this case, a Filterpack can be used to minimize interference.

● Wire thickness and wiring distance

When the wiring length between the inverter and motor is long, use thick wires so that the voltage drop of the main circuit cable is 2% or less especially at low frequency output. (A selection example for the wiring distance of 20m is shown on *page 65*)

Especially at a long wiring distance, the maximum wiring length should be within 500m since the overcurrent protection function may be misactivated by the influence of a charging current due to the stray capacitances of the wiring.

The overall wiring length for connection of multiple motors should be within the value in the table below. (Refer to *page 68* for IPM motors.)

	Wiring Length		
	50m or less	50m to 100m	Exceeding 100m
<i>Pr. 72</i> PWM frequency selection Setting (carrier frequency)	15 (14.5kHz) or less	8 (8kHz) or less	2 (2kHz) or less

When using the automatic restart after instantaneous power failure function during the general-purpose motor control with the wiring length longer than 100m, select "without frequency search" by setting *Pr.162* = "1 or 11". When connecting a parameter unit, use a recommended connection cable.

Use the recommended connection cable when installing the operation panel away from the inverter unit or when connecting the parameter unit.

For remote operation via analog signal, wire the control cable between the operation box or operation signal and inverter within 30m and away from the power circuits (main circuit and relay sequence circuit) to prevent induction from other devices.

When using the external potentiometer instead of the parameter unit to set the frequency, use a shielded or twisted cable, and do not earth (ground) the shield, but connect it to terminal 5 as shown below.

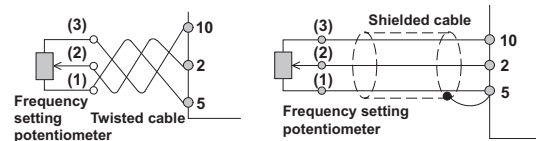

Features

Connection example

Standard specs.

Outline dimensions

Terminal connection diagrams
Terminal specs.

Operation panel
Parameter unit
FR Configurator

Parameter list

Parameter descriptions

Protective functions

Options

Precautions

Motor

IPM motor control

Compatibility

Warranty

● Earth (Ground)

When the inverter is run in the low acoustic noise mode, more leakage currents occur than in the non-low acoustic noise mode due to high-speed switching operation. Be sure to use the inverter and motor after grounding (earthing) them. In addition, always use the earth (ground) terminal of the inverter to earth (ground) the inverter. (Do not use the case and chassis)

● Noise

When performing low-noise operation at higher carrier frequency, electromagnetic noise tends to increase.

Therefore, refer to the following measure example and consider taking the measures. Depending on the installation condition, the inverter may be affected by noise in a non-low noise (initial) status.

- The noise level can be reduced by decreasing the carrier frequency (*Pr.72*).
- The Filterpack or FR-BIF radio noise filter is useful to suppress noise on AM radio broadcasting.
- The Filterpack or FR-BSF01/FR-BLF line noise filter is useful for preventing malfunction of sensors, etc.
- As measures against induction noise from the power cable of the inverter, an effect is produced by putting a distance of 30cm (at least 10cm) or more and using a shielded twisted pair cable as a signal cable. Do not earth (ground) shield but connect it to signal common cable.

Noise reduction examples

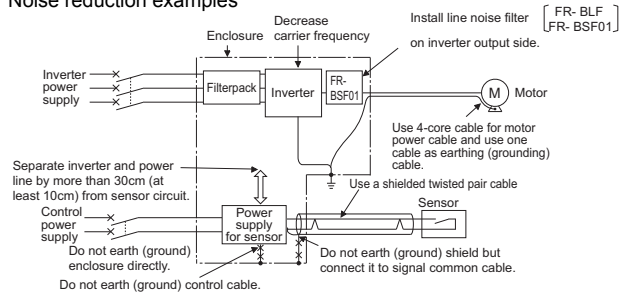

● Leakage currents

Capacitances exist between the inverter I/O cables, other cables and earth and in the motor, through which a leakage current flows. Since its value depends on the capacitances, carrier frequency, etc., low acoustic noise operation at the increased carrier frequency of the inverter will increase the leakage current. Therefore, take the following measures. Select the earth leakage breaker according to its rated sensitivity current, independently of the carrier frequency setting. (*Refer to page 66*)

To-earth (ground) leakage currents

Type	Influence and Measures
Influence and measures	<ul style="list-style-type: none"> Leakage currents may flow not only into the inverter's own line but also into the other lines through the earthing (grounding) cable, etc. These leakage currents may operate earth (ground) leakage circuit breakers and earth leakage relays unnecessarily. Countermeasures If the carrier frequency setting is high, decrease the <i>Pr. 72 PWM frequency selection</i> setting. Note that motor noise increases. Select <i>Pr. 240 Soft-PWM operation selection</i> to make the sound inoffensive. By using earth leakage circuit breakers designed for harmonic and surge suppression in the inverter's own line and other line, operation can be performed with the carrier frequency kept high (with low noise).
Undesirable current path	

Line leakage current

Type	Influence and Measures
Influence and measures	<ul style="list-style-type: none"> This leakage current flows via a static capacitance between the inverter output cables. The external thermal relay may be operated unnecessarily by the harmonics of the leakage current. When the wiring length is long (50m or more) for the 400V class small-capacity model (7.5kW or less), the external thermal relay is likely to operate unnecessarily because the ratio of the leakage current to the rated motor current increases. Countermeasures Use <i>Pr. 9 Electronic thermal O/L relay</i>. If the carrier frequency setting is high, decrease the <i>Pr. 72 PWM frequency selection</i> setting. Note that motor noise increases. Select <i>Pr. 240 Soft-PWM operation selection</i> to make the sound inoffensive. To ensure that the motor is protected against line-to-line leakage currents, it is recommended to use a temperature sensor to directly detect motor temperature.
Undesirable current path	<p style="text-align: center;">Line-to-line leakage currents path</p>

● Harmonic suppression guideline

Harmonic currents flow from the inverter to a power receiving point via a power transformer. The Harmonic Suppression Guidelines were established to protect other consumers from these outgoing harmonic currents.

The three-phase 200V input specifications 3.7kW or less are previously covered by "Harmonic Suppression Guidelines for Household Appliances and General-Purpose Products" and other models are covered by "Harmonic Suppression Guidelines for Consumers Who Receive High Voltage or Special High Voltage". However, the transistorized inverter has been excluded from the target products covered by "Harmonic Suppression Guidelines for Household Appliances and General-Purpose Products" in January 2004 and "Harmonic Suppression Guidelines for Household Appliances and General-Purpose Products" was repealed on September 6, 2004.

All capacity and all models of general-purpose inverter used by specific consumers are covered by "Harmonic Suppression Guidelines for Consumers Who Receive High Voltage or Special High Voltage" (hereinafter referred to as "Specific Consumer Guidelines").

· Harmonic Suppression Guideline for Consumers Who Receive High Voltage or Special High Voltage

This guideline sets forth the maximum values of harmonic currents outgoing from a high-voltage or especially high-voltage consumer who will install, add or renew harmonic generating equipment. If any of the maximum values is exceeded, this guideline requires that consumer to take certain suppression measures.

Users who use models other than the target models are not covered by the guideline. However, we ask to connect an AC reactor and a DC reactor as before.

For compliance to the "Harmonic Suppression Guideline for Consumers Who Receive High Voltage or Special High Voltage"

Input Power Supply	Target Capacity	Measures
Three-phase 200V Three-phase 400V	All capacities	Make a judgment based on the "Harmonic Suppression Guideline for Consumers Who Receive High Voltage or Special High Voltage" issued by the Japanese Ministry of Economy, Trade and Industry (formerly Ministry of International Trade and Industry) in September 1994 and take measures if necessary. For calculation method of power supply harmonics, refer to materials below. Reference materials · "Harmonic suppression measures of the general-purpose inverter" Jan., 2004 Japan Electrical Manufacturer's Association · "Calculation method of harmonic current of the general-purpose inverter used by specific consumers" JEM-TR201 (Revised in December 2003) : Japan Electrical Manufacturer's Association

For compliance to "Harmonic suppression guideline of the general-purpose inverter (input current of 20A or less) for consumers other than specific consumers" published by JEMA

Input Power Supply	Target Capacity	Measures
Three-phase 200V	3.7kW or less	Connect the AC reactor or DC reactor recommended in a catalog or an instruction manual. Reference materials · "Harmonic suppression guideline of the general-purpose inverter (input current of 20A or less)" JEM-TR226 (Revised in December 2003) : Japan Electrical Manufacturer's Association

● Calculation of outgoing harmonic current

Outgoing harmonic current = fundamental wave current (value converted from received power voltage) × operation ratio × harmonic content

- Operation ratio: Operation ratio = actual load factor × operation time ratio during 30 minutes
- Harmonic content: Found in Table.

Table 1: Harmonic content (Values of the fundamental current is 100%)

	Reactor	5th	7th	11th	13th	17th	19th	23th	25th
		Not used	65	41	8.5	7.7	4.3	3.1	2.6
Three-phase bridge (Capacitor smoothing)	Used (AC side)	38	14.5	7.4	3.4	3.2	1.9	1.7	1.3
	Used (DC side) or with Filterpack	30	13	8.4	5.0	4.7	3.2	3.0	2.2
	Used (AC, DC sides)	28	9.1	7.2	4.1	3.2	2.4	1.6	1.4

Table 2: Rated capacities and outgoing harmonic currents of inverter-driven motors

Applied Motor kW	Rated Current [A]		Fundamental Wave Current Converted from 6.6kV (mA)	Rated Capacity (kVA)	Fundamental Wave Current Converted from 6.6kV (No reactor, 100% operation ratio)									
	200V	400V			5th	7th	11th	13th	17th	19th	23th	25th		
	0.4	1.61			0.81	49	0.57	31.85	20.09	4.165	3.773	2.107	1.519	1.274
0.75	2.74	1.37	83	0.97	53.95	34.03	7.055	6.391	3.569	2.573	2.158	1.494		
1.5	5.50	2.75	167	1.95	108.6	68.47	14.20	12.86	7.181	5.177	4.342	3.006		
2.2	7.93	3.96	240	2.81	156.0	98.40	20.40	18.48	10.32	7.440	6.240	4.320		
3.7	13.0	6.50	394	4.61	257.1	161.5	33.49	30.34	16.94	12.21	10.24	7.092		
5.5	19.1	9.55	579	6.77	376.1	237.4	49.22	44.58	24.90	17.95	15.05	10.42		
7.5	25.6	12.8	776	9.07	504.4	318.2	65.96	59.75	33.37	24.06	20.18	13.97		
11	36.9	18.5	1121	13.1	728.7	459.6	95.29	86.32	48.20	34.75	29.15	20.18		
15	49.8	24.9	1509	17.6	980.9	618.7	128.3	116.2	64.89	46.78	39.24	27.16		

- Features
- Connection example
- Standard specs.
- Outline dimensions
- Terminal connection diagrams Terminal specs.
- Operation panel Parameter unit FR Configurator
- Parameter list
- Parameter descriptions
- Protective functions
- Options
- Precautions
- Motor
- IPM motor control
- Compatibility
- Warranty

Application to standard motor

● Motor loss and temperature rise

The motor operated by the inverter has a limit on the continuous operating torque since it is slightly higher in temperature rise than the one operated by a commercial power supply. At a low speed, reduce the output torque of the motor since the cooling effect decreases. When 100% torque is needed continuously at low speed, consider using a constant-torque motor.

● Torque characteristic

The motor operated by the inverter may be less in motor torque (especially starting torque) than the one driven by the commercial power supply. It is necessary to fully check the load torque characteristic of the machine.

● Motor torque

When the Mitsubishi standard squirrel-cage motor (SF-JR, 4-pole) and inverter of the same capacity are used, the torque characteristics are as shown below.

● Vibration

The machine-installed motor operated by the inverter may be slightly greater in vibration than the one driven by the commercial power supply. The possible causes of vibration are as follows.

1. Vibration due to imbalance of the rotator itself including the machine
2. Resonance due to the natural oscillation of the mechanical system. Caution is required especially when the machine used at constant speed is operated at variable speed. The frequency jump function allows resonance points to be avoided during operation. (During acceleration/deceleration, the frequency within the setting range is passed through.) An effect is also produced if the PWM carrier frequency in P_r : 72 is changed. When a two-pole motor is operated at higher than 60Hz, caution should be taken since such operation may cause abnormal vibration.

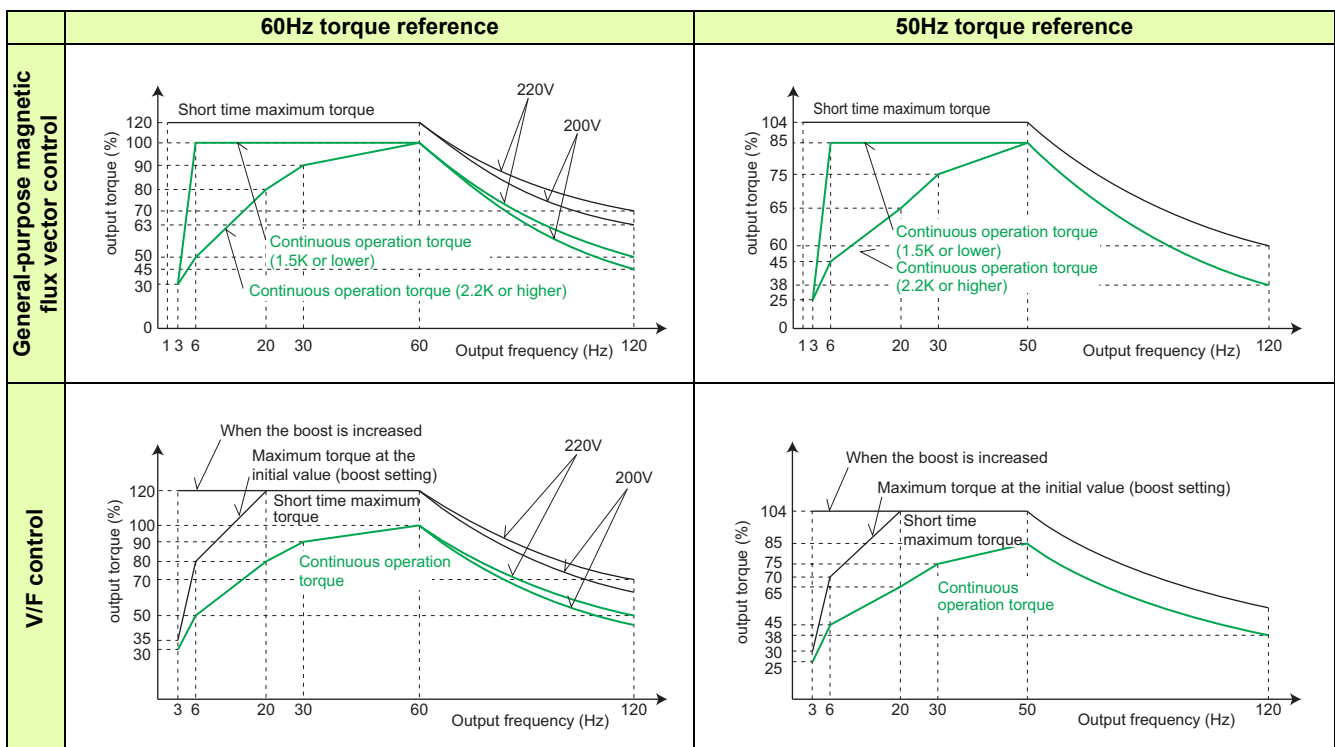

- The continuous operation torque is not an output torque of the motor. It is used to know the limit of permissible load torque for the use of motor within the permissible temperature range. The maximum output torque of the motor is indicated as the maximum short-time torque.
- Depending on the capacity or number of poles of the motor, operation at 60Hz or higher may not be available. Fully check the maximum permissible running frequency of the motor.
- The 60Hz torque reference indicates that the rated torque of the motor running at 60Hz is 100%, and the 50Hz torque reference indicates that the rated torque of the motor running at 50Hz is 100%
- For 3.7K, the characteristic is shown with the stall prevention operation level adjusted.
- To operate continuously with the 50Hz torque reference, reduce the load torque to 85% or less.
- Under V/F control, the same torque characteristics apply to the SF-JR type with two, four, or six poles.

Application to constant-torque motor

Since a constant-torque motor is greater in current than the standard motor, the inverter capacity may be one rank higher.

For a constant-torque motor, decrease the P_r :0 Torque boost setting.

Recommended value 0.75kW... 6%, 1.5 to 3.7kW... 4%, 5.5kW or higher... 2%

When two or more motors are operated synchronously, torque imbalance is likely to occur as motor slip is smaller than that of the standard motor.

Application to premium high-efficiency IPM motor [MM-EFS (1500r/min) series]

● Motor specification

Motor model	200V class MM-EFS□1M	7	15	22	37	55	75	11K	15K
	400V class MM-EFS□1M4								
Compatible inverter	200V class FR-F720PJ-□K	0.75	1.5	2.2	3.7	5.5	7.5	11	15
	400V class FR-F740PJ-□K								
Continuous characteristic *1	Rated output (kW)	0.75	1.5	2.2	3.7	5.5	7.5	11	15
	Rated torque (N•m)	4.77	9.55	14	23.6	35	47.7	70	95.5
Rated speed (r/min)		1500							
Maximum speed (r/min)		2250							
Number of poles		6							
Maximum torque		120% 60s							
Frame number		80M	90L	100L	112M	132S	132M	160M	160L
Moment of inertia J (×10 ⁻⁴ kg•m ²)		20	40	55	110	275	280	760	770
Rated current (A)	200V class	3.0	6.0	8.2	13.4	20	27	40	54
	400V class	1.5	3.0	4.1	6.7	10	13.5	20	27
Structure		Totally-enclosed fan-cooled motor. With steel framed legs. (protective structure IP44 *2)							
Insulation class		F class							
Vibration class		V-15							
Environment	Surrounding air temperature and humidity	-10°C to +40°C (non-freezing) 90%RH or less (non-condensing)							
	Storage temperature and humidity	-20°C to +70°C (non-freezing) 90%RH or less (non-condensing)							
	Atmosphere	Indoors (not under direct sunlight), and free from corrosive gas, flammable gas, oil mist, dust and dirt.							
	Altitude	Maximum 1,000m above sea level							
	Vibration	4.9m/s ²							
Mass(kg)		11	15	22	31	50	53	95	100

*1 The above characteristics apply when the rated AC voltage is input from the inverter. (Refer to page 8)
Output and rated motor speed are not guaranteed when the power supply voltage drops.

*2 This excludes the part where the axis passes through.

● Motor torque specification

The following figure shows the torque characteristic of the premium high-efficiency IPM motor [MM-EFS (1500r/min)series] when used with an inverter.

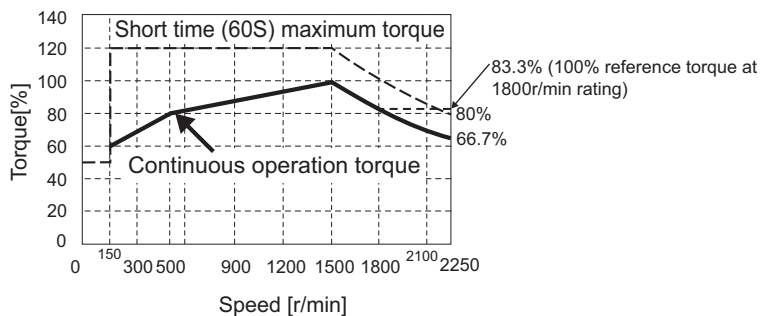

REMARKS

The motor can also be used for applications where the rated speed is 1800r/min.



NOTE

- The torque characteristic is when the armature winding temperature is 20°C, and the input voltage to the inverter is 200VAC or 400VAC.
- Constant-speed operation cannot be performed for the speed less than 150r/min.

Features

Connection example

Standard specs.

Outline dimensions

Terminal connection diagrams Terminal specs.

Operation panel Parameter unit FR Configurator

Parameter list

Parameter descriptions

Protective functions

Options

Precautions

Motor

IPM motor control

Compatibility

Warranty

● Outline drawing of motors

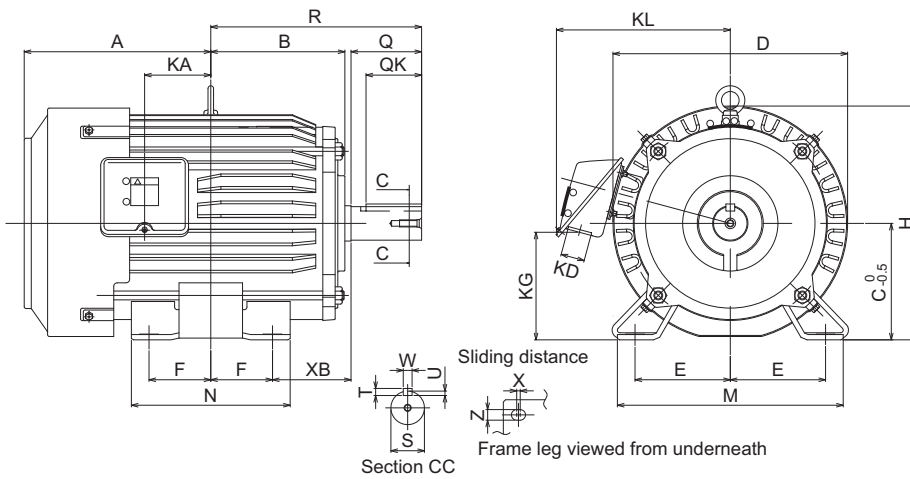

Model	Output (kW)	Frame number	Outline Dimension (mm)																							
			A	B	C	D	E	F	H	KA	KD	KG	KL	M	N	XB	Q	QK	R	S	T	U	W	X	Z	
200V class MM-EFS□1M	7	0.75	80M	122	95	80	161.6	62.5	50	164	39.5	27	63	145	160	125	50	40	32	140	φ19j6	6	3.5	6	15	9
	15	1.5	90L	143	110.5	90	183.6	70	62.5	182	53	27	76	158	175	150	56	50	40	168.5	φ24j6	7	4	8	15	9
	22	2.2	100L	173	128	100	207	80	70	203.5	65	27	88	169	200	180	63	60	45	193	φ28j6	7	4	8	4	12
400V class MM-EFS□1M4	37	3.7	112M	181	135	112	228	95	70	226	69	27	103	180	230	180	70	60	45	200	φ28j6	7	4	8	4	12
	55	5.5	132S	211.5	152	132	266	108	70	265	75	27	120	197	256	180	89	80	63	239	φ38k6	8	5	10	4	12
	75	7.5	132M	230.5	171	132	266	108	89	265	94	27	120	197	256	218	89	80	63	258	φ38k6	8	5	10	4	12
	11K	11	160M	252	198	160	318	127	105	316	105	56	142	266	310	254	108	110	90	323	φ42k6	8	5	12	4	14.5
	15K	15	160L	274	220	160	318	127	127	316	127	56	142	266	310	298	108	110	90	345	φ42k6	8	5	12	4	14.5



NOTE

- The outline dimensions are the dimensions of typical motors. The outer appearance may differ according to the frame number.

Inverter-driven 400V class motor

When driving a 400V class motor by the inverter, surge voltages attributable to the wiring constants may occur at the motor terminals, deteriorating the insulation of the motor. In such a case, consider taking the following measures.

(Under general-purpose motor control)

It is recommended to take either of the following measures.

- (1) Rectifying the motor insulation and limiting the PWM carrier frequency according to the wiring length
 For the 400V class motor, use an insulation-enhanced motor.
 Specifically,
 - 1)Specify the "400V class inverter-driven insulation-enhanced motor". (Mitsubishi standard motors (SF-JR, SB-JR 4-pole) are the 400V class inverter-driven reinforced insulation models.)
 - 2)For the dedicated motor such as the constant-torque motor and low-vibration motor, use the "inverter-driven, dedicated motor".
 - 3)Set *Pr. 72 PWM frequency selection* as indicated below according to the wiring length

	Wiring Length		
	50m or less	50m to 100m	exceeding 100m
<i>Pr. 72 PWM frequency selection</i>	15(14.5kHz) or less	8(8kHz) or less	2(2kHz) or less

- (2) Suppressing the surge voltage on the inverter side Connect the surge voltage suppression filter (FR-ASFH/FR-BMF-H) on the inverter output side.

(Under IPM motor control)

When the wiring length is 30m or longer, use the inverter at the carrier frequency of 2.5kHz (*Pr. 72* = "0 to 4").



NOTE

- The surge voltage suppression filter (FR-ASF-H/FR-BMF-H) option cannot be used under IPM motor control, so do not connect them.

Application to special motors

● Motor with an attached brake

Use a motor with a brake that has an independent power supply for the brake. Connect the brake power supply to the power supply on the input side of the inverter. During the brake operation (motor at a stop), turn OFF the inverter output using a terminal assigned for the output stop (MRS). Depending on the types of brake, a rattling noise may be made by the brake linings in the low-speed range. This is a normal operation and not a fault.

● Pole changing motor

As this motor differs in rated current from the standard motor, confirm the maximum current of the motor and select the inverter. Be sure to change the number of poles after the motor has stopped. If the number of poles is changed during rotation, the regenerative overvoltage protection circuit may be activated to cause an inverter alarm, coasting the motor to a stop.

● Submersible motor

The rated motor current is larger than that of the standard motor. Caution is required to ensure proper selection of the inverter capacity. The distance of wiring between the motor and the inverter tends to be longer. Use thick enough cables for wiring according to the recommendation in *page 65*. Compared to a motor for not submersed use, the leakage current tends to be increased. Caution is required to ensure proper selection of an earth leakage circuit breaker.

● Explosion-proof motor

To drive a pressure and explosion-proof motor, the explosion-proof test is required for the combination of motor and inverter. The explosion-proof test is also required for driving the existing explosion-proof motors. The FR-B and FR-B3 series inverters, which have passed the explosion-proof test, are also available. Please consult separately for details. The inverter body is not explosion proof. Install it in a non-hazardous place.

● Geared motor

The continuous operating rotation range of this motor changes depending on the lubrication system and maker. Especially in the case of oil lubrication, continuous operation in the low speed range only can cause gear seizure. For fast operation at higher than 60Hz, please consult the maker.

● Synchronous motor other than a dedicated IPM motor

This motor is not suitable for applications of large load variation or impact, where out-of-sync is likely to occur. Please contact us when using this motor because its starting current and rated current are greater than those of the standard motor and will not rotate stably at low speed.

● Single-phase motor

Single-phase motors are not suitable for variable-speed operation with an inverter.
 With the capacitor starting system, a harmonic current flows into the capacitor and the capacitor may be damaged. With the split-phase starting or repulsion starting system, the motor cannot generate sufficient output torque in the low-speed range and furthermore, the internal centrifugal switch does not operate, resulting in burnout of the starting coil. Replace the motor by a three-phase motor.

- Features
- Connection example
- Standard specs.
- Outline dimensions
- Terminal connection diagrams Terminal specs.
- Operation panel Parameter unit FR Configurator
- Parameter list
- Parameter descriptions
- Protective functions
- Options
- Precautions
- Motor
- IPM motor control
- Compatibility
- Warranty

Pr. 998, IPM

IPM motor control, IPM parameter initialization IPM

Pr.998 IPM parameter initialization *IPM IPM parameter initialization*

An IPM (interior permanent magnet) motor is a highly efficient motor compared to a general-purpose motor. Highly efficient motor control and highly accurate motor speed control can be performed by using the inverter with an IPM motor.

- For the motor model, dedicated IPM motor (MM-EFS model or MM-EF model) must be used.
- The motor capacity must be equivalent to the inverter capacity.
- Single-motor operation (one motor run by one inverter) must be performed.
- The overall wiring length with the motor must be within the specified value. (Refer to page 68)













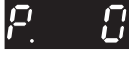

● Setting procedure of IPM motor control

This inverter is set for a general-purpose motor in the initial setting. Follow the following procedure to change the setting for the IPM motor control.

- IPM motor (MM-EFS) control setting from the operation panel (parameter setting mode)

POINT

- The parameters required to drive an IPM motor are automatically changed as a batch.
- To switch to the IPM motor control, initialize the parameter settings in the parameter setting mode or by setting *Pr.998*. If parameter initialization is performed after setting other parameters, some of those parameters will be initialized too. (Refer to the next page for the parameters initialized with this operation.)

Operation	Display
<p>1. Screen at power-ON The monitor display appears.</p>	
<p>2. Parameter setting mode Press  to choose the parameter setting mode.</p>	 →  (The parameter number read previously appears.)
<p>3. Selecting the parameter Turn  until 1 Pn (IPM parameter initialization) appears.</p>	 → 
<p>4. Displaying the setting Press  to read the currently set value. "0" (initial value) appears.</p>	 → 
<p>5. Selecting the setting Turn  to change it to the set value "12"</p>	 → 
<p>6. Parameter setting Press  to set.</p>	 → 
<p>↔ Flicker ... Parameter setting complete!!</p>	

Setting	Description
0	Parameter settings for a general-purpose motor
1	Parameter settings for a high-efficiency IPM motor MM-EF (rotations per minute)
12	Parameter settings for a premium high-efficiency IPM motor MM-EFS (rotations per minute)

 **REMARKS**

- Performing IPM parameter initialization in the parameter setting mode of the operation panel automatically changes the *Pr.998 IPM parameter initialization* setting.
- To check the control method (general-purpose motor control/IPM motor control), simply press the setting dial while the monitor screen is displayed. (Refer to page 18)
- The IPM parameter setting is displayed as "1, 12" in the parameter setting mode even if *Pr.998 IPM parameter initialization* = "101, 112."

- Initialization can be performed by setting *Pr.998 IPM parameter initialization* or by choosing the mode on the operation panel.

Pr.998 Setting	Description	Operation after selecting the parameter setting mode on the operation panel
0	Parameter settings for a general-purpose motor (frequency)	! Pn "IPM" ⇒ Write "0"
1	Parameter settings for a high-efficiency IPM motor MM-EF (rotations per minute)	! Pn "IPM" ⇒ Write "1"
12	Parameter settings for a premium high-efficiency IPM motor MM-EFS (rotations per minute)	! Pn "IPM" ⇒ Write "12"
101	Parameter settings for a high-efficiency IPM motor MM-EF (frequency)	Invalid
112	Parameter settings for a premium high-efficiency IPM motor MM-EFS (frequency)	Invalid

● IPM parameter initialization list

By selecting IPM motor control from the parameter setting mode or with *Pr.998 IPM parameter initialization*, the parameter settings in the following table change to the settings required to drive an IPM motor. The changed settings differ according to the IPM motor specification (capacity). Refer to the IPM motor specification list shown below.

Performing parameter clear or all parameter clear sets back the parameter settings to the settings required to drive a general-purpose motor.

Parameter	Name	Setting			Setting increments	
		General-purpose motor	IPM motor (rotations per minute)	IPM motor (frequency)	1, 12	0, 101, 112
	Pr.998	0 (Initial setting)	1 (MM-EF), 12 (MM-EFS)	101 (MM-EF), 112 (MM-EFS)		
1	Maximum frequency	120Hz	Maximum motor rotations per minute	Maximum motor frequency	1 r/min	0.01Hz
4	Multi-speed setting (high speed)	60Hz	Rated motor rotations per minute	Rated motor frequency	1 r/min	0.01Hz
9	Electronic thermal O/L relay	Rated inverter current	Rated motor current		0.01A	
13	Starting frequency	0.5Hz	Minimum rotations per minute	Minimum frequency	1 r/min	0.01Hz
15	Jog frequency	5Hz	Minimum rotations per minute	Minimum frequency	1 r/min	0.01Hz
18	High speed maximum frequency	120Hz	Maximum motor rotations per minute	Maximum motor frequency	1 r/min	0.01Hz
20	Acceleration/deceleration reference frequency	60Hz	Rated motor rotations per minute	Rated motor frequency	1 r/min	0.01Hz
22	Stall prevention operation level	120%	120% (Short-time motor torque)		0.1%	
37	Speed display	0	0		1	
55	Frequency monitoring reference	60Hz	Rated motor rotations per minute	Rated motor frequency	1 r/min	0.01Hz
56	Current monitoring reference	Rated inverter current	Rated motor current		0.01A	
71	Applied motor	0	Pr.998 = 1,101 : 120 Pr.998 = 12,112 : 210		1	
80	Motor capacity	9999	Inverter capacity*		0.01kW	
125(903)	Terminal 2 frequency setting gain frequency	60Hz	Rated motor rotations per minute	Rated motor frequency	1 r/min	0.01Hz
126(905)	Terminal 4 frequency setting gain frequency	60Hz	Rated motor rotations per minute	Rated motor frequency	1 r/min	0.01Hz
144	Speed setting switchover	4	106 (Number of motor poles + 100)	6 (Number of motor poles)	1	
240	Soft-PWM operation selection	1	0		1	
260	PWM frequency automatic switchover	1	1		1	
374	Overspeed detection level	9999	Maximum motor rotations per minute × 105%	Maximum motor frequency × 105%	1 r/min	0.01Hz
505	Speed setting reference	60Hz	Rated motor frequency		0.01Hz	
557	Current average value monitor signal output reference current	Rated inverter current	Rated motor current		0.01A	
870	Speed detection hysteresis	0Hz	10 r/min (Speed detection hysteresis rotations per minute)	0.5Hz (Speed detection hysteresis frequency)	1 r/min	0.01Hz
885	Regeneration avoidance compensation frequency limit value	6Hz	Minimum rotations per minute	Minimum frequency	1 r/min	0.01Hz

- Features
- Connection example
- Standard specs.
- Outline dimensions
- Terminal connection diagrams
- Terminal specs.
- Operation panel Parameter unit FR Configurator
- Parameter list
- Parameter descriptions
- Protective functions
- Options
- Precautions
- Motor
- IPM motor control
- Compatibility
- Warranty

Parameter	Name	Setting			Setting increments	
		General-purpose motor	IPM motor (rotations per minute)	IPM motor (frequency)		
	<i>Pr.998</i>	0 (Initial setting)	1 (MM-EF), 12 (MM-EFS)	101 (MM-EF), 112 (MM-EFS)	1, 12	0, 101, 112
893	Energy saving monitor reference (motor capacity)	Rated inverter capacity	Motor capacity (<i>Pr.80</i>)		0.01kW	
C24(923)	Frequency setting voltage gain frequency (built-in potentiometer)	60Hz	Rated motor rotations per minute	Rated motor frequency	1 r/min	0.01Hz

* When *Pr.80 Motor capacity* ≠ "9999," the *Pr.80 Motor capacity* setting is not changed by IPM parameter initialization. IPM parameter initialization is performed by setting *Pr.998 IPM parameter initialization* or the parameter setting mode on the operation panel.



REMARKS

- If IPM parameter initialization is performed in rotations per minute (*Pr. 998* = "1"), the frequency-related parameters not listed in the table above and the monitored items are also set and displayed in rotations per minute.
- The *Pr. 998* setting automatically changes the *Pr. 71* setting but does not change *Pr. 0 Torque boost* and *Pr. 12 DC injection brake operation voltage* settings.

<IPM motor specification list>

	MM-EF	MM-EFS
Rated motor frequency (rotations per minute)	90Hz (1800 r/min)	75Hz (1500 r/min)
Maximum motor frequency (rotations per minute)	135Hz (2700 r/min)	112.5Hz (2250 r/min)
Minimum frequency (rotations per minute)	9Hz (180 r/min)	7.5Hz (150 r/min)

● Specification comparison with the general-purpose motor

Item		IPM motor control	General-purpose motor control
Applicable motor		Premium high-efficiency IPM motor MM-EFS series (the same capacity as the inverter capacity)	General-purpose motor SF-JR, HR series, etc. (the same or one-rank higher capacity compared to the inverter)
Number of connectable motors		1: 1	Several motors can be driven under V/F control.
Number of motor poles		6 poles	Normally 2, 4, or 6 poles.
Rated motor frequency		75Hz	Normally 50Hz or 60Hz
Maximum output frequency		112.5Hz (6P 2250r/min)	400Hz (12000r/min with 4P) (Set the upper limit frequency (<i>Pr.1, Pr.18</i>) according to the motor and machine specifications.)
Permissible load		120% 60s, 150% 0.5s (inverse-time characteristics) (The % value is a ratio to the rated motor current.)	120% 60s, 150% 0.5s (inverse-time characteristics) (The % value is a ratio to the rated inverter current.)
Maximum starting torque		50%	120% (General-purpose magnetic flux vector control)
Frequency setting resolution	Analog input	0.018Hz/0 to 75Hz (1500r/min) (0 to 10V / 12 bits) 0.036Hz/0 to 75Hz (1500r/min) (0 to 5V / 11 bits, 0 to 20mA / 11 bits, 0 to ±10V / 12 bits) 0.072Hz/0 to 75Hz (1500r/min) (0 to ±5V / 11 bits)	0.015Hz/0 to 60Hz (1800r/min with 4P) (0 to 10V / 12 bits) 0.03Hz/0 to 60Hz (1800r/min with 4P) (0 to 5V / 11 bits, 0 to 20mA / 11 bits, 0 to ±10V / 12 bits) 0.06Hz/0 to 60Hz (1800r/min with 4P) (0 to ±5V / 11 bits)
Output signal	Pulse output for meter	In the initial setting, 1mA is output at 75Hz from across terminals FM and SD. (SD is a common terminal.) The permissible frequency load current is 2mA. For pulse specification, 1440 pulses/s is output at 75Hz.	In the initial setting, 1mA is output at 60Hz from across terminals FM and SD. (SD is a common terminal.) The permissible frequency load current is 2mA. For pulse specification, 1440 pulses/s is output at 60Hz.
Carrier frequency		five patterns of 2.5kHz, 5kHz, 7.5kHz, 10kHz and 12.5kHz	0.75kHz to 14.5kHz

Item	IPM motor control	General-purpose motor control
Automatic restart after instantaneous power failure	No startup waiting time. Using the regeneration avoidance function together is recommended.	Startup waiting time exists.
Startup delay	Startup delay of about 0.1s for initial tuning.	No startup delay.
Driving by the commercial power supply	Not available. Never connect an IPM motor to the commercial power supply.	Can be driven by the commercial power supply.
Operation during coasting	While the motor is coasting, potential is generated across motor terminals. Before wiring, make sure that the motor is stopped.	While the motor is coasting, no potential is generated across motor terminals.
Maximum motor wiring length	FR-F740PJ-0.4K..... 50m or shorter FR-F720PJ-0.4K to 15K, FR-F740PJ-0.75K to 15K 100m or shorter	500m or shorter in total



NOTE

- No slippage occurs with an IPM motor because of its characteristic.
If an IPM motor, which took over a general-purpose motor, is driven at the same speed as for the general-purpose motor, the running speed of the IPM motor becomes faster by the amount of the general-purpose motor's slippage.
Adjust the speed command to run the IPM motor at the same speed as the general-purpose motor, as required.

- Features
- Connection example
- Standard specs.
- Outline dimensions
- Terminal connection diagrams
Terminal specs.
- Operation panel
Parameter unit
FR Configurator
- Parameter list
- Parameter descriptions
- Protective functions
- Options
- Precautions
- Motor
- IPM motor control
- Compatibility
- Warranty

Main differences and compatibilities with the FR-F500J series



Item	FR-F500J	FR-F700PJ
Control method	V/F control Automatic torque boost	V/F control General-purpose magnetic flux vector control Optimum excitation control IPM motor control
Output frequency range	0.5 to 120Hz	0.2 to 400Hz
Changed initial value	<i>Pr. 0 Torque boost</i> FR-F520J-1.5K to 3.7K: 6% FR-F540J-1.5K, 2.2K: 5%	FR-F720PJ-1.5K to 3.7K: 4% FR-F740PJ-1.5K, 2.2K: 4%
	<i>Pr. 1 Maximum frequency</i> 60Hz	120Hz
Changed setting increments	<i>Pr. 88 PID action selection</i> 20 (PID reverse action) Turn the X14 signal ON to enable PID control.	<i>Pr. 128 PID action selection</i> 0 (PID control disabled) Set <i>Pr. 128</i> ≠ "0" to enable PID control. (An X14 signal input is not required when X14 is unassigned.)
	<i>Pr. 37 Speed display</i> 0.1	0.001
Changed setting value	<i>H1(Pr. 503) Maintenance timer</i> <i>H2(Pr. 504) Maintenance timer alarm output set time</i> Time per increments: 1000h <i>H2(Pr. 504) Initial value: 87 (87000h)</i> (Example) To set 87000h, set <i>H2 (Pr. 504)</i> = "87."	<i>Pr. 503 Maintenance timer</i> <i>Pr. 504 Maintenance timer alarm output set time</i> Time per increments: 100h Initial value: 9999 (no function) (Example) To set 87000h, set <i>Pr. 504</i> = "870."
	<i>Pr. 52 Control panel display data selection</i> 1: Output current	<i>Pr. 52 DU/PU main display data selection</i> 0/100: Output current (select with SET)
Deleted functions	<i>Pr.54 FM terminal function selection</i> 0: Output frequency (initial value), 1: Output current	1: Output frequency (initial value), 2: Output current
	<i>Pr. 60 to Pr. 63 Input terminal function selection</i> 5: STOP signal (start self-holding selection) 6: MRS signal (output stop) 9: JOG signal (Jog operation selection) 10: RES signal (reset) ---: STR signal (reverse rotation command)	<i>Pr. 178 to Pr. 182 Input terminal function selection</i> 5: JOG signal (Jog operation selection) 6: None 24: MRS signal (output stop) 25: STOP signal (start self-holding selection) 61: STR signal (reverse rotation command) 62: RES signal (reset)
Deleted functions	<i>Pr. 73 Terminal 2 0 to 5V, 0 to 10V selection</i> 0: 0 to 5V (initial value), 1: 0 to 10V	<i>Pr. 73 Analog input selection</i> 0: 0 to 10V, 1: 0 to 5V (initial value)
	<i>Pr. 98 Automatic torque boost selection</i> <i>Pr. 99 Motor primary resistance</i> Long wiring mode (setting value 10, 11 of <i>Pr. 70</i>)	Replacement function (General-purpose magnetic flux vector control) (<i>Pr. 80 Motor capacity</i>) (<i>Pr. 90 Motor constant</i>) Setting unnecessary (setting values 10 and 11 of <i>Pr. 240</i> are deleted)

Item	FR-F500J		FR-F700PJ	
	Parameter Number	Name	Parameter Number	Name
Changed parameter number and name	Pr. 17	RUN key rotation direction selection	Pr. 40	RUN key rotation direction selection
	Pr. 21	Stall prevention function selection	Pr. 156	Stall prevention operation selection
	Pr. 28	Stall prevention operation reduction starting frequency	Pr. 66	Stall prevention operation reduction starting frequency
	Pr. 30	Extended function display selection	Pr. 160	Extended function display selection
	Pr. 38	Frequency setting voltage gain frequency	Pr. 125	Terminal 2 frequency setting gain frequency
	Pr. 39	Frequency setting current gain frequency	Pr. 126	Terminal 4 frequency setting gain frequency
	Pr. 40	Start-time ground fault detection selection	Pr. 249	Earth (ground) fault detection at start
	Pr. 48	Output current detection level	Pr. 150	Output current detection level
	Pr. 49	Output current detection signal delay time	Pr. 151	Output current detection signal delay time
	Pr. 50	Zero current detection level	Pr. 152	Zero current detection level
	Pr. 51	Zero current detection time	Pr. 153	Zero current detection time
	Pr. 53	Frequency setting operation selection	Pr. 161	Frequency setting/key lock operation selection
	Pr. 60	AU terminal function selection	Pr. 180	AU terminal function selection
	Pr. 61	RM terminal function selection	Pr. 181	RM terminal function selection
	Pr. 62	RH terminal function selection	Pr. 182	RH terminal function selection
	Pr. 63	STR terminal function selection	Pr. 179	STR terminal function selection
	Pr. 64	RUN terminal function selection	Pr. 190	RUN terminal function selection
	Pr. 65	A, B, C terminal function selection	Pr. 192	A,B,C terminal function selection
	Pr. 66	Retry selection	Pr. 65	Retry selection
	Pr. 70	Soft-PWM setting	Pr. 240	Soft-PWM operation selection
	Pr. 76	Cooling fan operation selection	Pr. 244	Cooling fan operation selection
	Pr. 80	Multi-speed setting (speed 8)	Pr. 232	Multi-speed setting (speed 8)
	Pr. 81	Multi-speed setting (speed 9)	Pr. 233	Multi-speed setting (speed 9)
	Pr. 82	Multi-speed setting (speed 10)	Pr. 234	Multi-speed setting (speed 10)
	Pr. 83	Multi-speed setting (speed 11)	Pr. 235	Multi-speed setting (speed 11)
	Pr. 84	Multi-speed setting (speed 12)	Pr. 236	Multi-speed setting (speed 12)
	Pr. 85	Multi-speed setting (speed 13)	Pr. 237	Multi-speed setting (speed 13)
	Pr. 86	Multi-speed setting (speed 14)	Pr. 238	Multi-speed setting (speed 14)
	Pr. 87	Multi-speed setting (speed 15)	Pr. 239	Multi-speed setting (speed 15)
	Pr. 88	PID action selection	Pr. 128	PID action selection
	Pr. 89	PID proportional band	Pr. 129	PID proportional band
	Pr. 90	PID integral time	Pr. 130	PID integral time
	Pr. 91	PID upper limit	Pr. 131	PID upper limit
	Pr. 92	PID lower limit	Pr. 132	PID lower limit
	Pr. 93	PID action set point for PU operation	Pr. 133	PID action set point
	Pr. 94	PID differential time	Pr. 134	PID differential time
	Pr. 95	Rated motor slip	Pr. 245	Rated slip
Pr. 96	Slip compensation time constant	Pr. 246	Slip compensation time constant	
Pr. 97	Constant power range slip compensation selection	Pr. 247	Constant-power range slip compensation selection	
n1(Pr. 331)	Communication station number	Pr. 117	PU communication station number	
n2(Pr. 332)	Communication speed	Pr. 118	PU communication speed	
n3(Pr. 333)	Stop bit length	Pr. 119	PU communication stop bit length	
n4(Pr. 334)	Parity check presence/absence	Pr. 120	PU communication parity check	
n5(Pr. 335)	Number of communication retries	Pr. 121	Number of PU communication retries	
n6(Pr. 336)	Communication check time interval	Pr. 122	PU communication check time interval	
n7(Pr. 337)	Waiting time setting	Pr. 123	PU communication waiting time setting	
n11(Pr. 341)	CR/LF setting	Pr. 124	PU communication CR/LF selection	
n16(Pr. 992)	PU main display screen data selection	Pr. 52	DU/PU main display data selection	
n17(Pr. 993)	Disconnected PU detection/PU setting lock	Pr. 75	Reset selection/disconnected PU detection/PU stop selection	
Screw size of main circuit terminals	FR-F540J-15: M6		FR-F740PJ-15K: M5	
Control terminal block	Screw type terminal block Fix a wire with a flathead screw (Screw size: M2(M3 for terminal A, B, C)) Length of recommended blade terminal: 6mm		Spring clamp terminal block Fix a wire with a pressure of inside spring Length of recommended blade terminal: 10mm (Blade terminal of FR-F500J is unavailable)	
PU	FR-PU04		FR-PU07 FR-PU04 (some functions, such as parameter copy, are unavailable.)	
Installation size	Installation size is compatible for all capacities.			

Features

Connection example

Standard specs.

Outline dimensions

Terminal connection diagrams
Terminal specs.Operation panel
Parameter unit
FR Configurator

Parameter list

Parameter descriptions

Protective functions

Options

Precautions

Motor

IPM motor control

Compatibility

Warranty

[Contents]

1. Warranty period and coverage

We will repair any failure or defect (hereinafter referred to as "failure") in our FA equipment (hereinafter referred to as the "Product") arisen during warranty period at no charge due to causes for which we are responsible through the distributor from which you purchased the Product or our service provider. However, we will charge the actual cost of dispatching our engineer for an on-site repair work on request by customer in Japan or overseas countries. We are not responsible for any on-site readjustment and/or trial run that may be required after a defective unit are repaired or replaced.

[Term]

The term of warranty for Product is twelve months after your purchase or delivery of the Product to a place designated by you or eighteen months from the date of manufacture whichever comes first ("Warranty Period"). Warranty period for repaired Product cannot exceed beyond the original warranty period before any repair work.

[Limitations]

- (1) You are requested to conduct an initial failure diagnosis by yourself, as a general rule. It can also be carried out by us or our service company upon your request and the actual cost will be charged.
However, it will not be charged if we are responsible for the cause of the failure.
- (2) This limited warranty applies only when the condition, method, environment, etc. of use are in compliance with the terms and conditions and instructions that are set forth in the instruction manual and user manual for the Product and the caution label affixed to the Product.
- (3) Even during the term of warranty, the repair cost will be charged on you in the following cases;
 - 1) a failure caused by your improper storing or handling, carelessness or negligence, etc., and a failure caused by your hardware or software problem
 - 2) a failure caused by any alteration, etc. to the Product made on your side without our approval
 - 3) a failure which may be regarded as avoidable, if your equipment in which the Product is incorporated is equipped with a safety device required by applicable laws and has any function or structure considered to be indispensable according to a common sense in the industry
 - 4) a failure which may be regarded as avoidable if consumable parts designated in the instruction manual, etc. are duly maintained and replaced
 - 5) any replacement of consumable parts (condenser, cooling fan, etc.)
 - 6) a failure caused by external factors such as inevitable accidents, including without limitation fire and abnormal fluctuation of voltage, and acts of God, including without limitation earthquake, lightning and natural disasters
 - 7) a failure generated by an unforeseeable cause with a scientific technology that was not available at the time of the shipment of the Product from our company
 - 8) any other failures which we are not responsible for or which you acknowledge we are not responsible for
2. Term of warranty after the stop of production
 - (1) We may accept the repair at charge for another seven years after the production of the product is discontinued.
The announcement of the stop of production for each model can be seen in our Sales and Service, etc.
 - (2) Please note that the Product (including its spare parts) cannot be ordered after its stop of production.
3. Service in overseas countries
Our regional FA Center in overseas countries will accept the repair work of the Product; However, the terms and conditions of the repair work may differ depending on each FA Center. Please ask your local FA center for details.
4. Exclusion of responsibility for compensation against loss of opportunity, secondary loss, etc.
Whether under or after the term of warranty, we assume no responsibility for any damages arisen from causes for which we are not responsible, any losses of opportunity and/or profit incurred by you due to a failure of the Product, any damages, secondary damages or compensation for accidents arisen under a specific circumstance that are foreseen or unforeseen by our company, any damages to products other than the Product, and also compensation for any replacement work, readjustment, start-up test run of local machines and the Product and any other operations conducted by you.
5. Change of Product specifications
Specifications listed in our catalogs, manuals or technical documents may be changed without notice.
6. Application and use of the Product
 - (1) For the use of our product, its applications should be those that may not result in a serious damage even if any failure or malfunction occurs in the product, and a backup or fail-safe function should operate on an external system to the product when any failure or malfunction occurs.
 - (2) Our product is designed and manufactured as a general purpose product for use at general industries.
Therefore, applications substantially influential on the public interest for such as atomic power plants and other power plants of electric power companies, and also which require a special quality assurance system, including applications for railway companies and government or public offices are not recommended, and we assume no responsibility for any failure caused by these applications when used.
In addition, applications which may be substantially influential to human lives or properties for such as airlines, medical treatments, railway service, incineration and fuel systems, man-operated material handling equipment, entertainment machines, safety machines, etc. are not recommended, and we assume no responsibility for any failure caused by these applications when used.
We will review the acceptability of the abovementioned applications, if you agree not to require a specific quality for a specific application. Please contact us for consultation.

International FA Center

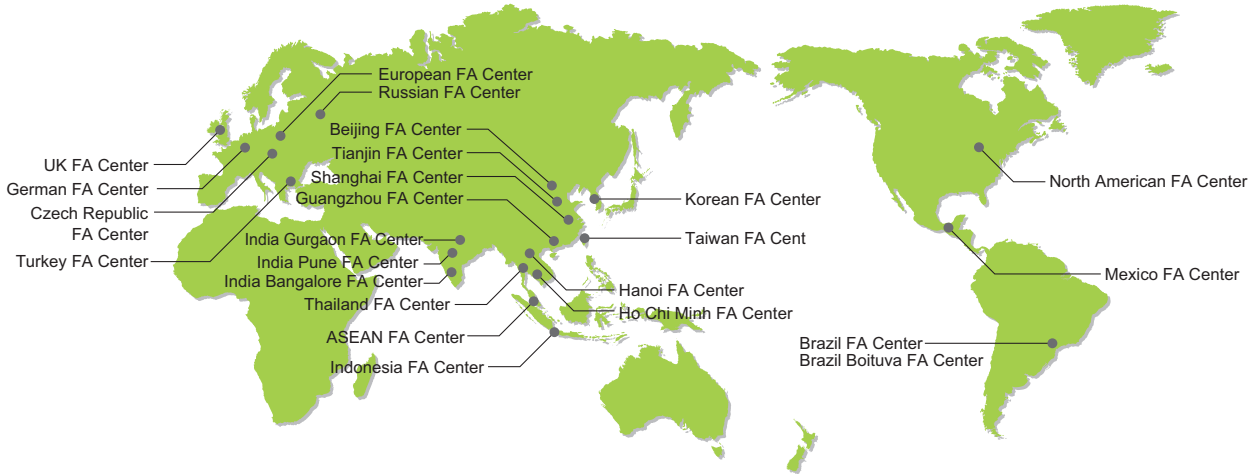

●Shanghai FA Center

MITSUBISHI ELECTRIC AUTOMATION (CHINA) LTD.
10F, Mitsubishi Electric Automation Center, No.1386 Hongqiao Road, Changning District, Shanghai, China
TEL. 86-21-2322-3030
FAX. 86-21-2322-3000 (9611#)

●Beijing FA Center

MITSUBISHI ELECTRIC AUTOMATION (CHINA) LTD. Beijing Office
Unit 908, Office Tower 1, Henderson Centre, 18 Jianguomennei Avenue, Dongcheng District, Beijing, China
TEL. 86-10-6518-8830
FAX. 86-10-6518-3907(Before Service)
FAX. 86-10-6518-2938(After Service)

●Tianjin FA Center

MITSUBISHI ELECTRIC AUTOMATION (CHINA) LTD. Tianjin Office
Room 2003 City Tower, No.35, Youyi Road, Hexi District, Tianjin, China
TEL. 86-22-2813-1015
FAX. 86-22-2813-1017

●Guangzhou FA Center

MITSUBISHI ELECTRIC AUTOMATION (CHINA) LTD. Guangzhou Office
Room 1609, North Tower, The Hub Center, No.1068, Xingang East Road, Haizhu District, Guangzhou, China
TEL. 86-20-8923-6730
FAX. 86-20-8923-6715

●Korean FA Center

MITSUBISHI ELECTRIC AUTOMATION KOREA CO., LTD.
B1F, 2F, 1480-6, Gayang-Dong, Gangseo-Gu, Seoul, 157-200, Korea
TEL. 82-2-3660-9630
FAX. 82-2-3663-0475

●Taiwan FA Center

SETSUYO ENTERPRISE CO., LTD.
3F, No.105, Wugong 3rd Road, Wugu District, New Taipei City 24889, Taiwan, R.O.C.
TEL. 886-2-2299-9917
FAX. 886-2-2299-9963
MITSUBISHI ELECTRIC TAIWAN CO.,LTD.
No.8-1, Industrial 16th Road, Taichung Industrial Park, Taichung City 40768 Taiwan, R.O.C.
TEL. 886-4-2359-0688
FAX. 886-4-2359-0689

●Thailand FA Center

MITSUBISHI ELECTRIC FACTORY AUTOMATION (THAILAND) CO., LTD.
12th Floor, SV.City Building, Office Tower 1, No. 896/19 and 20 Rama 3 Road, Kwaeng Bangpongpan, Khet Yannawa, Bangkok 10120, Thailand
TEL. 66-2682-6522 to 31
FAX. 66-2682-6020

●ASEAN FA Center

MITSUBISHI ELECTRIC ASIA PTE. LTD.
307, Alexandra Road, Mitsubishi Electric Building, Singapore 159943
TEL. 65-6470-2480
FAX. 65-6476-7439

●Indonesia FA Center

PT. MITSUBISHI ELECTRIC INDONESIA Gedung Jaya 11th Floor, JL.MH. Thamrin No.12, Jakarta, Pusat 10340, Indonesia
TEL. 62-21-3192-6461
FAX. 62-21-3192-3942

●Hanoi FA Center

MITSUBISHI ELECTRIC VIETNAM COMPANY LIMITED Hanoi Branch
Unit 9-05, 9th Floor, Hanoi Central Office Building, 44B Ly Thuong Kiet Street, Hoan Kiem District, Hanoi City, Vietnam
TEL. 84-4-3937-8075
FAX. 84-4-3937-8076

●Ho Chi Minh FA Center

MITSUBISHI ELECTRIC VIETNAM COMPANY LIMITED
Unit 01 - 04, 10th Floor, Vincom Center, 72 Le Thanh Ton Street, District 1, Ho Chi Minh City, Vietnam
TEL. 84-8-3910-5945
FAX. 84-8-3910-5947

●India Pune FA Center

MITSUBISHI ELECTRIC INDIA PVT. LTD. Pune Branch
Emerald House, EL-3, J Block, M.I.D.C., Bhosari, Pune, 411026, Maharashtra State, India
TEL. 91-20-2710-2000
FAX. 91-20-2710-2100

●India Gurgaon FA Center

MITSUBISHI ELECTRIC INDIA PVT. LTD. Gurgaon Head Office
2nd Floor, Tower A & B, Cyber Greens, DLF Cyber City, DLF Phase - áv, Gurgaon - 122002 Haryana, India
TEL. 91-124-463-0300
FAX. 91-124-463-0399

●India Bangalore FA Center

MITSUBISHI ELECTRIC INDIA PVT. LTD. Bangalore Branch
Prestige Emerald, 6th Floor, Municipal No.2, Madras Bank Road, Bangalore 560001, India
TEL. 91-80-4020-1600
FAX. 91-80-4020-1699

●North American FA Center

MITSUBISHI ELECTRIC AUTOMATION, INC.
500 Corporate Woods Parkway, Vernon Hills, IL 60061, U.S.A.
TEL. 1-847-478-2334
FAX. 1-847-478-2253

●Mexico FA Center

MITSUBISHI ELECTRIC AUTOMATION, INC. Mexico Branch
Mariano Escobedo #69, Col.Zona Industrial, Tlalnepantla Edo. C.P.54030, Mexico
TEL. 52-55-3067-7511

●Brazil FA Center

MITSUBISHI ELECTRIC DO BRASIL COMERCIO E SERVICOS LTDA.
Rua Jussara, 1750- Bloco B Anexo, Jardim Santa Cecilia, CEP 06465-070, Barueri - SP, Brasil
TEL. 55-11-4689-3000
FAX. 55-11-4689-3016

●Brazil Boituva FA Center

MELCO CNC DO BRASIL COMERCIO E SERVICOS S.A.
Acesso Jose Sartorelli, KM 2.1 CEP 18550-000 Boituva-SP, Brasil
TEL. 55-15-3363-9900
FAX. 55-15-3363-9911

●European FA Center

MITSUBISHI ELECTRIC EUROPE B.V. Polish Branch
32-083 Balice ul. Krakowska 50, Poland
TEL. 48-12-630-47-00
FAX. 48-12-630-47-01

●German FA Center

MITSUBISHI ELECTRIC EUROPE B.V. German Branch
Gothaer Strasse 8, D-40880 Ratingen, Germany
TEL. 49-2102-486-0
FAX. 49-2102-486-1120

●UK FA Center

MITSUBISHI ELECTRIC EUROPE B.V. UK Branch
Travellers Lane, Hatfield, Hertfordshire, AL10 8XB, UK.
TEL. 44-1707-28-8780
FAX. 44-1707-27-8695

●Czech Republic FA Center

MITSUBISHI ELECTRIC EUROPE B.V. Czech Branch
Avenir Business Park, Radicka 751/113e, 158 00 Praha5, Czech Republic
TEL. 420-251-551-470
FAX. 420-251-551-471

●Russian FA Center

MITSUBISHI ELECTRIC EUROPE B.V. Russian Branch St.Petersburg office
Piskarevsky pr. 2, bld 2, lit "Sch", BC "Benua", office 720; 195027, St. Petersburg, Russia
TEL. 7-812-633-3497
FAX. 7-812-633-3499

●Turkey FA Center

MITSUBISHI ELECTRIC TURKEY AS Umraniye Branch
Serifali Mahallesi Nutuk Sokak No:5 TR-34775 Umraniye, Istanbul, Turkey
TEL. 90-216-526-3990
FAX. 90-216-526-3995

Features

Connection example

Standard specs.

Outline dimensions

Terminal connection diagrams Terminal specs.

Operation panel Parameter unit FR Configurator

Parameter list

Parameter descriptions

Protective functions

Options

Precautions

Motor

IPM motor control

Compatibility

Warranty

[Related Factory Automation Products]

PLC | MELSEC-Q Series Universal Model



Introducing the high-speed QCPU (QnUDVCPU) for faster processing of large data volumes.

- ◎Realize high-speed, high-accuracy machine control with various iQ Platform compatible controllers and multiple CPUs.
- ◎Easily connect to GOTs and Programming tools using built-in Ethernet port.
- ◎25 models from 10k step small capacity to 1000k step large capacity, are available.
- ◎Seamless communication and flexible integration at any network level.

Product Specifications

Program capacity	10k steps to 1000k steps
Number of I/O points [X/Y], number of I/O device points [X/Y]	256 points to 4096 points/8192 points
Basic instruction processing speed (LD instruction)	120 ns to 1.9 ns
External connection interface	USB (all models equipped), Ethernet, RS-232, memory card, extended SRAM cassette
Function module	I/O, analog, high-speed counter, positioning, simple motion, temperature input, temperature control, network module
Module extension style	Building block type
Network	Ethernet, CC-Link IE controller network, CC-Link IE field network, CC-Link, CC-Link/LT, MELSECNET/H, SSCNET III (/H), AnyWire, RS-232, RS-422

Programmable Controller | MELSEC-L Series



“Light & Flexible” condensing various functions easily and flexibly.

- ◎CPU equipped as a standard with various functions including counter, positioning and CC-Link.
- ◎The base-less structure with high degree of freedom saves space in the control panel.
- ◎Easily confirm the system status and change the settings with the display unit.
- ◎Ten models are available in program capacities from 20k steps to 260k steps.

Product specifications

Program capacity	20k steps/60k steps/260k steps
Number of input/output points [X/Y]	1024 points/4096 points
Number of input/output device points [X/Y]	8192 points
Basic instruction processing speed (LD instruction)	60 ns/ 40 ns/ 9.5 ns
External connection interface	USB, Ethernet, RS-232, SD memory card, CC-Link (L26CPU-BT/PBT)
Function modules	I/O, analog, high-speed counter, positioning, simple motion, temperature control, network module
Unit expansion style	Base-less structure
Network	Ethernet, CC-Link IE Field network, CC-Link, CC-Link/LT, SSCNET III(/H), RS-232, RS-422

HMI | Graphic Operation Terminal GOT2000 Series GT27 Model



To the top of HMIs with further user-friendly, satisfactory standard features.

- ◎Comfortable screen operation even if high-load processing (e.g. logging, device data transfer) is running. (Monitoring performance is twice faster than GT16)
- ◎Actual usable space without using an SD card is expanded to 128MB for more flexible screen design.
- ◎Multi-touch features, two-point press, and scroll operations for more user-friendliness.
- ◎Outline font and PNG images for clear, beautiful screen display.

Product Specifications

Screen size	12.1", 10.4", 8.4" (15" coming soon)
Resolution	SVGA, VGA (XGA coming soon)
Intensity adjustment	32-step adjustment
Touch panel type	Analog resistive film
Built-in interface	RS-232, RS-422/485, Ethernet, USB, SD card
Applicable software	GT Works3
Input power supply voltage	100 to 240VAC (+10%, -15%), 24VDC (+25%, -20%)

Magnetic Starter | MS-T Series



Exceed your expectations.

- ◎10A frame model is over 16% smaller with a width of just 36mm!
- ◎New integrated terminal covers.
- ◎Reduce your coil inventory by up to 50%.
- ◎Certified to the highest international levels while work is ongoing to gain other country standards.

Product specifications

Frame	10 A to 32 A
Applicable standards	Certification to various standards including IEC, JIS, CE, UL, TÜV, CCC.
Terminal cover	Standard terminal cover improves safety, simplifies ordering, and reduces inventory, etc.
Improved wiring	Wiring and operability are improved with streamlining wiring terminal BC specifications.
Operation coil rating	Wide range of operation coil ratings reduces number of coil types from 14 (N Series) to 7 types and simplifies selection.
Option units	Diverse lineup includes Auxiliary Contact Block, Operation Coil Surge Absorber Unit, Mechanical Interlock Unit.

AC Servo | Mitsubishi General-Purpose AC Servo MELSERVO-J4 Series



Industry-leading level of high performance servo

- ◎Industry-leading level of basic performance: Speed frequency response (2.5kHz), 4,000,000 (4,194,304p/rev) encoder
- ◎Advanced one-touch tuning function achieves the one-touch adjustment of advanced vibration suppression control II, etc.
- ◎Equipped with large capacity drive recorder and machine diagnosis function for easy maintenance.
- ◎2-axis and 3-axis servo amplifiers are available for energy-conservative, space-saving, and low-cost machines.

Product Specifications

Power supply specifications	1-phase/3-phase 200V AC, 3-phase 400V AC
Command interface	SSCNET III/H, SSCNET III (compatible in J3 compatibility mode), CC-Link IE Field Network interface with Motion, pulse train, analog
Control mode	Position/Speed/Torque/Fully closed loop
Speed frequency response	2.5kHz
Tuning function	Advanced one-touch tuning, advanced vibration suppression control II, robust filter, etc.
Safety function	STO, SS1
	SS2, SOS, SLS, SBC, SSM (compatible when combined with motion controller)
Compatible servo motor	Rotary servo motor (rated output: 0.05 to 22kW), linear servo motor (continuous thrust 50 to 3000N), direct drive motor (rated torque: 2 to 240N·m)

Three-Phase Motor | High Performance Energy-Saving Motor Super Line Premium Series SF-PR



High Efficiency & Compatible. New Launch of Super Line Premium Series SF-PR Model

- ◎Compared to general-purpose motor SF-JR model, generated loss is reduced by 37% on average, and it is compatible with highly efficient premium IE3.
- ◎Easy replacement is achieved as mounting dimension (frame number) is compatible with general-purpose motor SF-JR model.
- ◎One motor can accommodate different power sources of Japan and the U.S. Three ratings in Japan meet the Top Runner standards, while it corresponds to EISA in the U.S.
- ◎Can be driven by inverters as standard. Advanced magnetic-flux vector control by our FR-A800 achieves steady torque drive up to 0.5Hz.

Product Specifications

Number of poles	2-poles, 4-poles, 6-poles
Voltage-Frequency	200/200/220/230V 50/60/60/60Hz EISA 230V 60Hz or 400/400/440/460V 50/60/60/60Hz EISA 460V 60Hz
Exterior	Totally enclosed fan cooled type (inside, outside installation)
Protection system	IP44
Electrically-driven power system	Motor with 2-poles over 11kW is dedicated for a direct connection. Motors with 4-poles and 6-poles are for both direct and crossed belt connections.
Rotation direction	Counter-clock-wise (CCW) direction viewed from the edge of axis.
Compatible standard	JEC-2137-2000 (Efficiency is compatible with IEC 60034-30.)

 **Safety Warning**

To ensure proper use of the products listed in this catalog, please be sure to read the instruction manual prior to use.



for a greener tomorrow

Eco Changes is the Mitsubishi Electric Group's environmental statement, and expresses the Group's stance on environmental management. Through a wide range of businesses, we are helping contribute to the realization of a sustainable society.



MITSUBISHI ELECTRIC CORPORATION

HEAD OFFICE: TOKYO BLDG., 2-7-3, MARUNOUCHI, CHIYODA-KU, TOKYO 100-8310, JAPAN