

Mark Sensor with Stainless Steel Housing

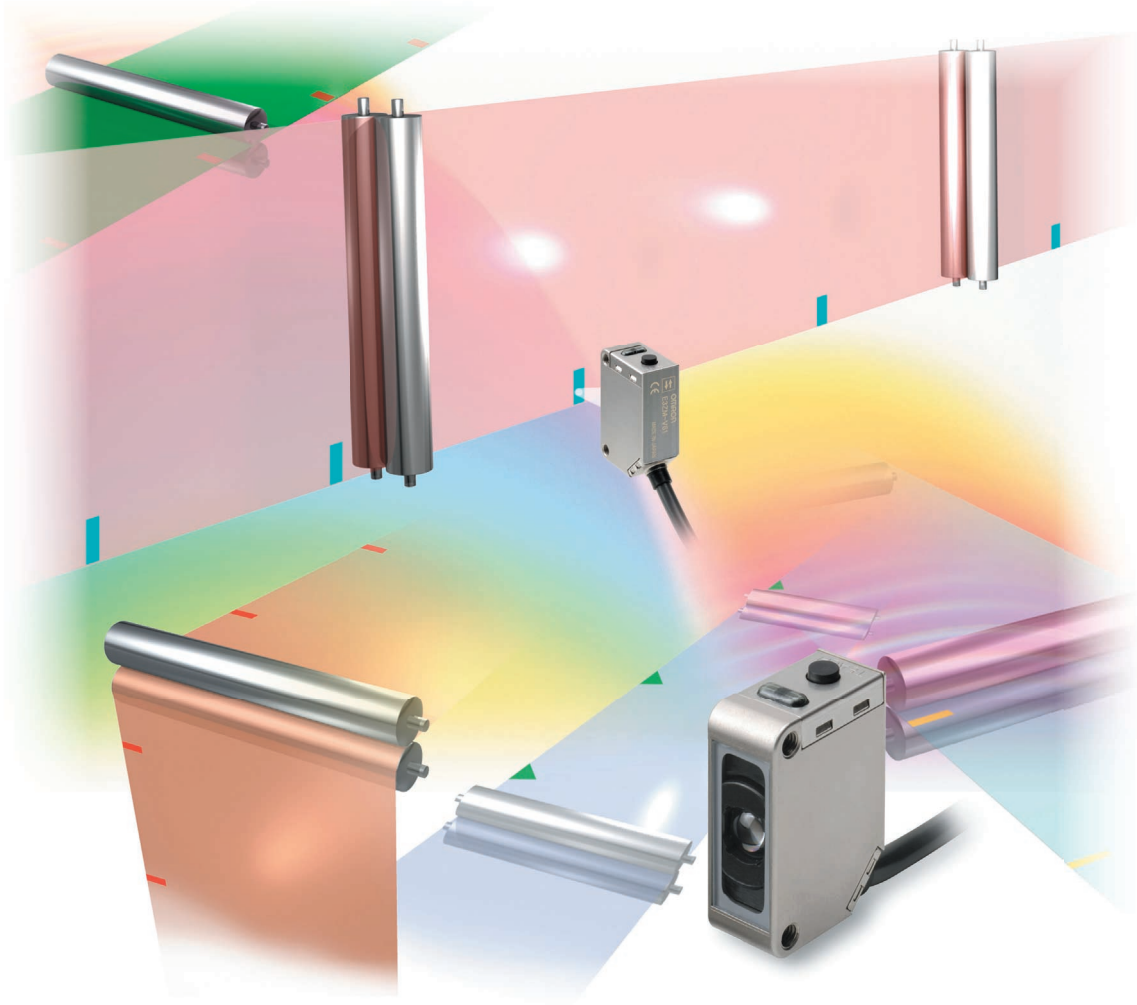

Compact, Photoelectric Sensor with Built-in Amplifier and Teaching Function

- » Color Mark Detection a World-standard Size (11 x 21 x 32 mm)
- » High speed response (50 μ s)
- » Accuracy in Despite of Sensing Object

World's Smallest* Color-Mark Sensor with Built-in Amplifier

The E3ZM-V provides superior optical performance and yet is the same size as the E3Z. This compact, high-speed Mark Sensor remains accurate in spite of sensing object movement.

Color Mark Sensors Now Join the E3ZM Series of Photoelectric Sensors for the Food Industry

Space-saving Design with an SUS316L Housing

E3ZM Standard Size

The compact design reduces volume by 90% compared with previous OMRON models, and the world-standard dimensions contribute to standardized installation specifications.



Coaxial Optical System in a Compact Design

Although the E3ZM-V is only 11 × 21 × 32 mm, it uses a coaxial optical system.

Even if the sensing object is inclined, reflected light is captured with the coaxial optical system to provide stable detection.

Straight Sensing Object

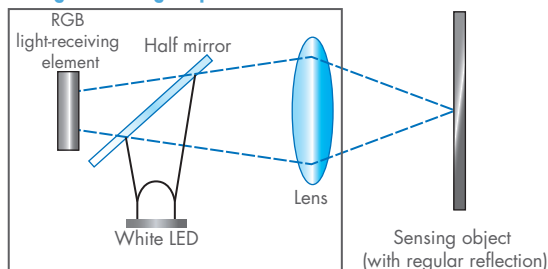

Inclined Sensing Object

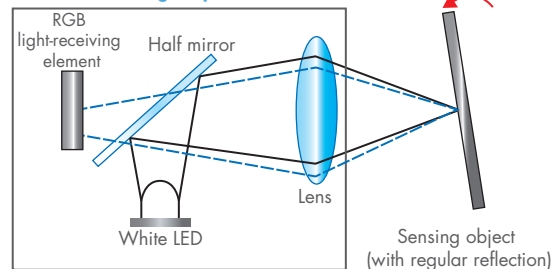

IP69K Degree of Protection with an SUS316L Housing

E3ZM Durability

The housing is constructed of corrosion-resistant SUS316L, and the display cover is PES (polyethersulfone). Both materials are highly resistant to the effects of detergents and disinfectants. IP69K degree of protection also allows the E3ZM-V to withstand washing with high-temperature, high-pressure water. This makes the E3ZM-V well suited to use in sites requiring a high level of hygiene.



* According to Omron investigation.



Cutting-edge Technologies Give This Color Mark Sensor Its Compact Size and Superior Performance

Improved Color-difference Discrimination, RGB Signal Processing

Discriminates fine color differences which was difficult for previous OMRON models.

Teaching enables automatic selection of ideal colors.

Response is a fast 50 μ s for both ON and OFF operation (Patent Pending).

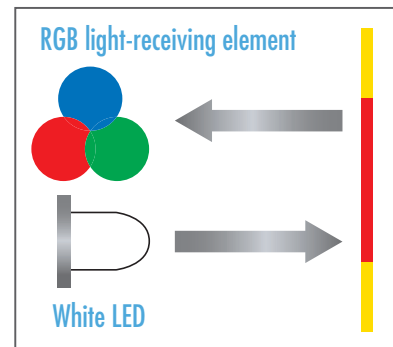

Easy Setting with 2-point and Automatic Teaching

2-point Teaching (Manual)

Simply aim the beam spot at the mark portion and background portion, and press the teaching button.



Automatic Teaching (Remote)

Send a pulse to the remote control input and have the mark pass by seven times for automatic teaching.

(Note: There is no answer-back output.)

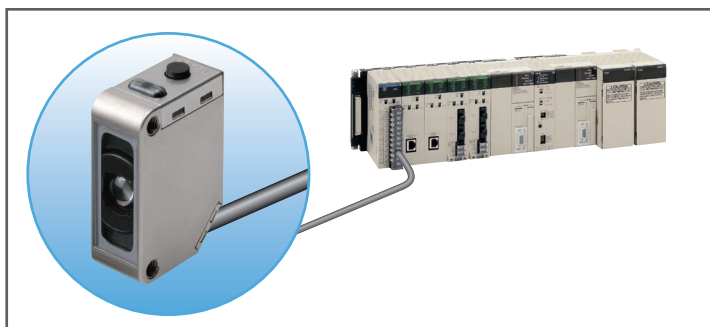

Industry's Smallest Color Mark Sensor*

- Space-saving design 90% smaller than previous OMRON model (E3M-V). Plus, an SUS316L housing for IP69K protection.
- Improved color-difference discrimination, and white LED+ RGB signal processing.
- Coaxial optical system maintains accuracy even against sensing object movement.
- Two Teaching methods available: 2-point Teaching (manual) and Automatic Teaching (remote).



* According to Omron investigation.



Ordering Information

Sensor

 White light



Sensing method	Appearance	Connection method	Sensing distance		Model	
					NPN output	PNP output
Mark Sensor (Diffuse reflective)		Pre-wired (2 m) *1		12±2 mm *2	E3ZM-V61 2M	E3ZM-V81 2M
		Connector (M8, 4 pins)			E3ZM-V66	E3ZM-V86

*1. Models with a 5-m pre-wired cable are also available. When ordering, add the cable length to the end of the model number (e.g., E3ZM-V61 5M).

*2. A deviation of ±2 mm (typical value) can be handled for combinations of white, yellow, and black. Refer to page 7 for the detection capability for other color combinations.









Accessories

Sensor I/O Connectors

Size	Cable	Appearance	Cable type	Model	
M8 (4 pins)	Standard	Straight 	2 m	4-wire	XS3F-M421-402-A
			5 m		XS3F-M421-405-A
		L-shaped 	2 m		XS3F-M422-402-A
			5 m		XS3F-M422-405-A

Note: The outer cover of the cable is made of PVC (polyvinyl chloride), the nut is SUS316L, and the degree of protection is IP67. When high-pressure washing will be used, select an I/O Connector that has IP69K degree of protection.

Mounting Brackets

Appearance	Model (Material)	Quantity	Remarks	Appearance	Model (Metal material)	Quantity	Remarks
	E39-L153 (SUS304)	1	Mounting Brackets		E39-L98 (SUS304)	1	Protective Cover Bracket *
	E39-L104 (SUS304)	1			E39-L150 (SUS304)	1 set	(Sensor adjuster) Easily mounted to the aluminum frame rails of conveyors and easily adjusted. For vertical angle adjustment
	E39-L43 (SUS304)	1	Horizontal Mounting Bracket *		E39-L151 (SUS304)	1 set	
	E39-L142 (SUS304)	1	Horizontal Protective Cover Bracket *				
	E39-L44 (SUS304)	1	Rear Mounting Bracket		E39-L144 (SUS304)	1	Compact Protective Cover Bracket *

* Cannot be used for Standard Connector models.

Sensing method		Diffuse reflective (mark detection)
Model	NPN output	E3ZM-V61/-V66
Item	PNP output	E3ZM-V81/-V86
Sensing distance	12±2 mm *1	
Sensing range	Depends on the combination of colors. Refer to <i>Engineering Data</i> on page 7 for details.	
Spot diameter	2-mm dia. max.	
Light source (wavelength)	White LED (450 to 700 nm)	
Power supply voltage	10 to 30 VDC, including 10% ripple (p-p)	
Power consumption	600 mW max. (current consumption for a 30-V power supply voltage: 20 mA max.)	
Control output	Load power supply voltage: 30 VDC max., Load current: 100 mA max. (Residual voltage: 2 V max.) Open-collector output (NPN/PNP output depending on model)	
Remote control input	NPN output ON: Short-circuit to 0 V, or 1.5 V max. (source current: 1 mA max.) NPN output OFF: Open or Vcc -1.5 V to Vcc (leakage current: 0.1 mA max.) PNP output ON: Vcc -1.5 V to Vcc (sink current: 1 mA max.) PNP output OFF: Open or 1.5 V max. (leakage current: 0.1 mA max.)	
Operating modes	Set in the order of the teaching operation. *2	
Protection circuits	Reversed power supply polarity, Load short-circuit protection, and Reversed output polarity protection	
Response time	Operate or reset: 50 µs max.	
Sensitivity adjustment	Teaching method	
Ambient illumination	(Receiver side) Incandescent lamp: 3,000 lx max., Sunlight: 10,000 lx max.	
Ambient temperature range	Operating: -40 to 60°C (*3), Storage: -40 to 70°C (with no icing or condensation)	
Ambient humidity range	Operating: 35% to 85%, Storage: 35% to 95% (with no condensation)	
Insulation resistance	20 MΩ min. (at 500 VDC)	
Dielectric strength	1,000 VAC at 50/60 Hz for 1 min	
Vibration resistance (destruction)	10 to 55 Hz, 1.5-mm double amplitude for 2 h each in X, Y, and Z directions	
Shock resistance (destruction)	500 m/s ² for 3 times each in X, Y, and Z directions	
Degree of protection	IEC 60529: IP67, DIN 40050-9: IP69K	
Connection method	Pre-wired cable (standard length: 2 m) or M8 4-pin connector	
Indicator	Operating indicator (yellow), Stability indicator (green), and Teaching indicator (red)	
Weight (packed state)	Pre-wired models (2-m cable): Approx. 85 g Connector models: Approx. 35 g	
Materials	Housing	SUS316L
	Lens	PMMA (polymethylmethacrylate)
	Indication	PES (polyethersulfone)
	Buttons	Fluoro rubber
	Cable	PVC (polyvinyl chloride)
Accessories	Instruction sheet Note: Mounting Brackets are purchased separately.	

*1. A deviation of ±2 mm (typical value) can be handled for combinations of white, yellow, and black. Refer to page 7 for the detection capabilities for other colors.

*2. Mark Sensor output switching:
When teaching, specify the ON color first and the OFF color second.

*3. Do not bend the cable in temperatures of -25°C or lower.

Standard Sensing Object for the Mark Sensor

Color	Munsell color notation
White	N9.5
Red	4R 4.5/12.0
Yellow-red	4YR 6.0/11.5
Yellow	5Y 8.5/11.0
Yellow-green	3GY 6.5/10.0
Green	3G 6.5/9.0
Blue-green	5BG 4.5/10.0
Blue	3PB 5.0/10.0
(Black)	(N2.0)

Color vs. Detection Capability

E3ZM-V□□

Teaching Capabilities

	White	Red	Yellow-red	Yellow	Yellow-green	Green	Blue-green	Blue	Black
White	○	○	○	○	○	○	○	○	○
Red	○	○	○	○	○	○	○	○	○
Yellow-red	○	○	○	○	○	○	○	○	○
Yellow	○	○	○	○	○	○	○	○	○
Yellow-green	○	○	○	○	○	○	○	○	○
Green	○	○	○	○	○	○	○	○	○
Blue-green	○	○	○	○	○	○	○	○	○
Blue	○	○	○	○	○	○	○	○	○
Black	○	○	○	○	○	○	○	○	○

* The above chart shows the combinations of colors for which teaching is possible at a sensing distance of 12 mm.

Detectable Ranges

E3ZM-V□□

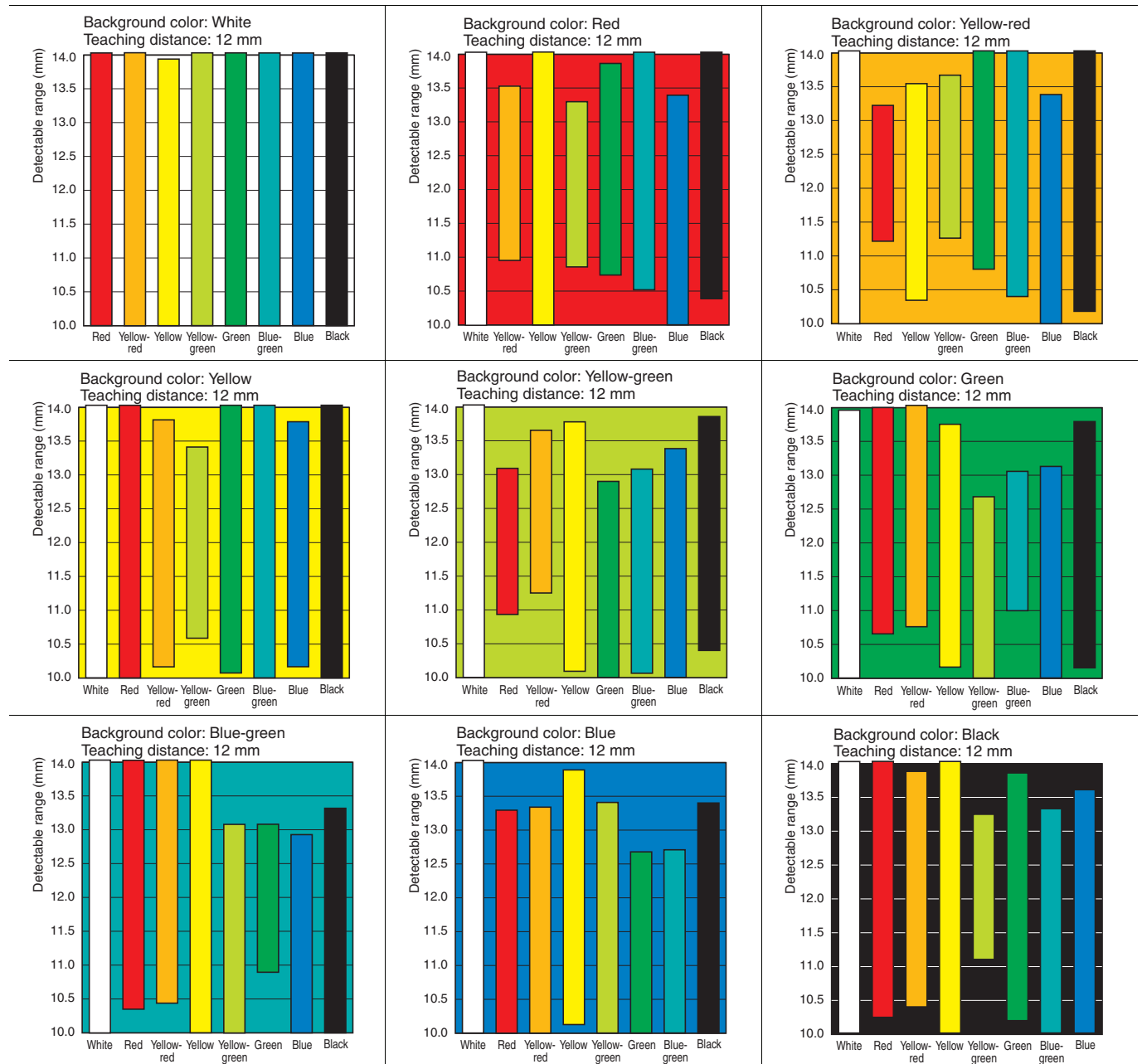

Excess Gain vs. Distance

E3ZM-V□□

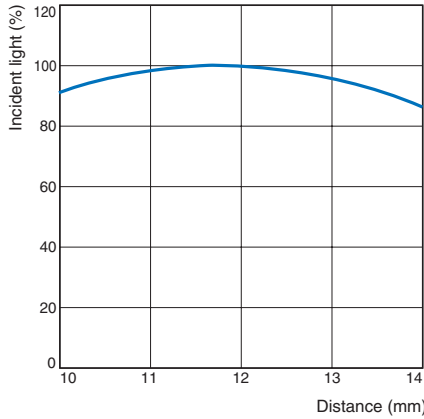

Angle vs. Incident Characteristics

E3ZM-V□□

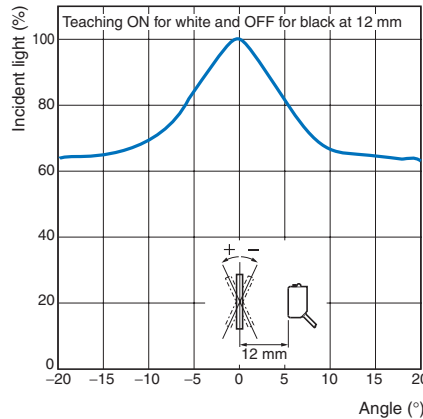

E3ZM-V□□

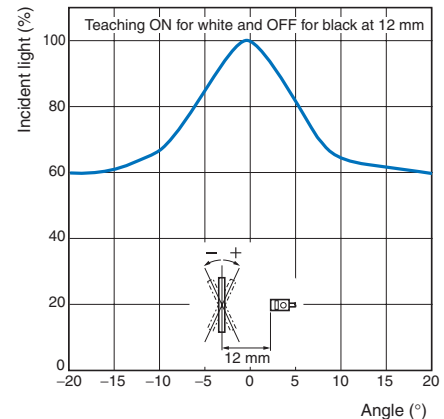

I/O Circuit Diagrams

NPN Output

Model	Timing charts	Output circuit
E3ZM-V61 E3ZM-V66	<p>Between brown (1) and black (4) leads</p>	<p>M8 Connector Pin Arrangement</p>

PNP Output

Model	Timing charts	Output circuit
E3ZM-V81 E3ZM-V86	<p>Between blue (3) and black (4) leads</p>	<p>M8 Connector Pin Arrangement</p>

Plugs (Sensor I/O Connectors)

M8 4-pin Connectors

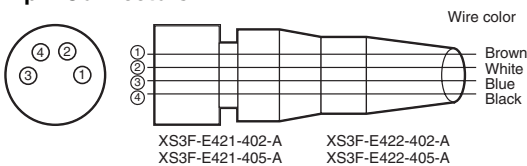

Classification	Wire color	Connector pin No.	Application
DC	Brown	1	Power supply (+V)
	White	2	Remote control input
	Blue	3	Power supply (0 V)
	Black	4	Output

Note: The above M8 Connectors made by OMRON are IP67.
Do not use them in an environment where IP69K is required.

Teaching Models



Safety Precautions

WARNING

This product is not designed or rated for directly or indirectly ensuring safety of persons. Do not use it for such a purpose.



CAUTION

Do not use the product with voltage in excess of the rated voltage. Excess voltage may result in malfunction or fire.



Never use the product with an AC power supply. Otherwise, explosion may result.



When cleaning the product, do not apply a high-pressure spray of water to one part of the product. Otherwise, parts may become damaged and the degree of protection may be degraded.



Precautions for Safe Use

The following precautions must be observed to ensure safe operation of the Sensor.

Operating Environment

Do not use the Sensor in an environment where explosive or flammable gas is present.

Connecting Connectors

Be sure to hold the connector cover when inserting or removing the connector.

When using an XS3F Connector, be sure to tighten the connector lock by hand; do not use pliers or other tools. If the tightening is insufficient, the degree of protection will not be maintained and the Sensor may become loose due to vibration. The appropriate tightening torque is 0.3 to 0.4 N·m. When using another, commercially available connector, follow the usage and tightening torque instructions provided by the manufacturer.

Load

Do not use a load that exceeds the rated load.

Low-temperature Environments

Do not touch the metal surface with your bare hands when the temperature is low. Touching the surface may result in a cold burn.

Oily Environments

Do not use the Sensor in oily environments. They may damage parts and reduce the degree of protection.

Modifications

Do not attempt to disassemble, repair, or modify the Sensor.

Outdoor Use

Do not use the Sensor in locations subject to direct sunlight.

Cleaning

Do not use thinner, alcohol, or other organic solvents. Otherwise, the optical properties and degree of protection may be degraded.

Do not use highly concentrated cleaning agents. Otherwise, malfunction may result. Also, do not use high-pressure water with a level of pressure that exceeds the stipulated level. Otherwise, the degree of protection may be reduced.

Surface Temperature

Burn injury may occur. The Sensor surface temperature rises depending on application conditions, such as the ambient temperature and the power supply voltage. Use caution when operating or performing maintenance on the Sensor.

Cable Bending

Do not bend the cable in temperatures of -25°C or below. Otherwise, the cable may be damaged.

Precautions for Correct Use

Do not use the Sensor in any atmosphere or environment that exceeds the ratings.

Do not install the Sensor in the following locations.

- (1) Locations subject to direct sunlight
- (2) Locations subject to condensation due to high humidity
- (3) Locations subject to corrosive gas
- (4) Locations where the Sensor may receive direct vibration or shock

Connecting and Mounting

- (1) The maximum power supply voltage is 30 VDC. Before turning the power ON, make sure that the power supply voltage does not exceed the maximum voltage.
- (2) Laying Sensor wiring in the same conduit or duct as high-voltage wires or power lines may result in malfunction or damage due to induction. As a general rule, wire the Sensor in a separate conduit or use shielded cable.
- (3) Use an extension cable with a minimum thickness of 0.3 mm² and less than 50 m long.
- (4) Do not pull on the cable with excessive force.
- (5) Pounding the Photoelectric Sensor with a hammer or other tool during mounting will impair water resistance. Also, use M3 screws.
- (6) Mount the Sensor either using the bracket (sold separately) or on a flat surface.
- (7) Be sure to turn OFF the power supply before inserting or removing the connector.

Power Supply

If a commercial switching regulator is used, ground the FG (frame ground) terminal.

Power Supply Reset Time

The Sensor will be able to detect objects 100 ms after the power supply is turned ON. Start using the Sensor 100 ms or more after turning ON the power supply. If the load and the Sensor are connected to separate power supplies, be sure to turn ON the Sensor first.

Turning OFF the Power Supply

Output pulses may be generated even when the power supply is OFF. Therefore, it is recommended to first turn OFF the power supply for the load or the load line.

Load Short-circuit Protection

This Sensor is equipped with load short-circuit protection, but be sure to not short circuit the load. Be sure to not use an output current flow that exceeds the rated current. If a load short-circuit occurs, the output will turn OFF, so check the wiring before turning ON the power supply again. The short-circuit protection circuit will be reset. The load short-circuit protection will operate when the current flow reaches 1.8 times the rated load current. When using a capacitive load, use an inrush current of 1.8 times the rated load current or lower.

Water Resistance

Do not use the Sensor in water, rainfall, or outdoors.

When disposing of the Sensor, treat it as industrial waste.

Mounting Diagram

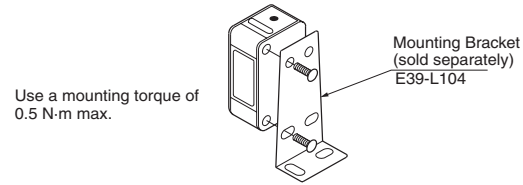

Resistance to Detergents, Disinfectants, and Chemicals

- The Sensor will maintain sufficient performance in typical detergents and disinfectants, but performance may suffer in some types of detergents, disinfectants, and chemicals. Refer to the following table prior to use.
- The E3ZM has passed detergent and disinfectant resistance testing for the substances listed in the following table. Use this table as a guide when considering detergents and disinfectants.

Type	Product name	Concentration	Temperature	Time
Chemicals	Sodium hydroxide, NaOH	1.5%	70°C	240 h
	Potassium hydroxide, KOH	1.5%	70°C	240 h
	Phosphoric acid, H ₃ PO ₄	2.5%	70°C	240 h
	Sodium hypochlorite, NaClO	0.3%	25°C	240 h
	Hydrogen peroxide, H ₂ O ₂	6.5%	25°C	240 h
Alkaline foaming cleansers	Topax 66s (Ecolab)	3.0%	70°C	240 h
Acidic foaming cleansers	Topax 56 (Ecolab)	5.0%	70°C	240 h
Disinfectants	Oxonia Active 90 (Ecolab)	1.0%	25°C	240 h
	TEK121 (ABC Compounding)	1.1%	25°C	240 h

Note: The Sensor was immersed in the above chemicals, detergents, and disinfectants for 240 h at the temperatures given, and then passed an insulation resistance test at 100 MΩ min.

Restrictions on Sensing Objects

Do not use this Sensor if the color and pattern of the background are similar to those of the mark.

Detection of Glossy Objects

Mount the Sensor at an angle of 5° to 15°, as shown in the following diagram. This will improve the mark detection capability.

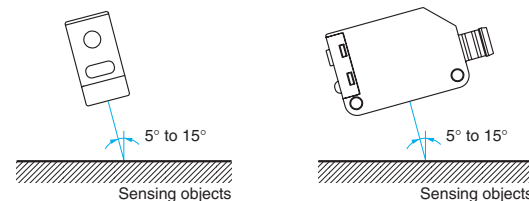

Two-point Teaching Using Teaching Button

1. Place the point for which you want the output to go ON in the beam spot position. Then, press and hold the teaching button for at least 2 seconds.

The teaching indicator (red) will begin flashing quickly. (This indicates that the output ON teaching operation should begin.) Perform the following operation within 7 seconds of when you start pushing the button. (After 7 seconds, the Unit will return to its initial condition.)

2. Press the teaching button for approximately 0.5 second. The teaching indicator (red) will light for approximately 0.5 second to show that the output ON teaching is completed.

The teaching indicator (red) will then begin flashing quickly again to show that the output OFF teaching operation should begin.

3. Place the point where you want the output to go OFF in the beam spot position.

4. Press the teaching button for approximately 0.5 second. The teaching indicator (red) will light for approximately 0.5 second to show that the output OFF teaching is completed.

When Teaching Is Successful

The stability indicator (green) shows that detection is stable.

- 1.Lights
→ This indicates stable detection, even if there is some fluttering in the sensing object.
- 2.Flashes
→ This indicates the possibility of unstable detection, due to fluttering in the sensing object.
- 3.Remains OFF
→ This indicates unstable detection.

The Sensor enters normal operating condition.

	Stable detection	Unstable detection
ON point	Lit Lit	Off Lit
OFF point	Lit Off	Off Off

When Teaching Is Not Successful

The teaching indicator (red) flashes slowly. (Flashes in cycles of approx. 6 seconds.)

Repeat the operation starting with step 1.

Automatic Teaching (Remote)

1. Send a pulse with a duration of at least 2 seconds but less than 10 seconds to the remote control input (pink).
2. Teaching will be performed automatically when the mark (the light level with the shorter detection time) passes through the beam spot.
 - Make sure the mark passes through the beam spot for at least 1.5 ms.
 - Pass the mark through the beam spot at least seven times to complete the teaching process.
 - There must be a difference in light intensity between the mark and the background for teaching to be successful.
3. Detection will begin and the output will turn ON when the mark (the light level with the shorter detection time) is detected.

Note: Determine when teaching has been completed by confirming that the output turns ON for the mark and OFF for the background within one minute after the remote control input is applied. If the output does not turn ON for the mark and OFF for the background within one minute after the remote control input is applied, teaching has not been successful. Apply the remote control input again.

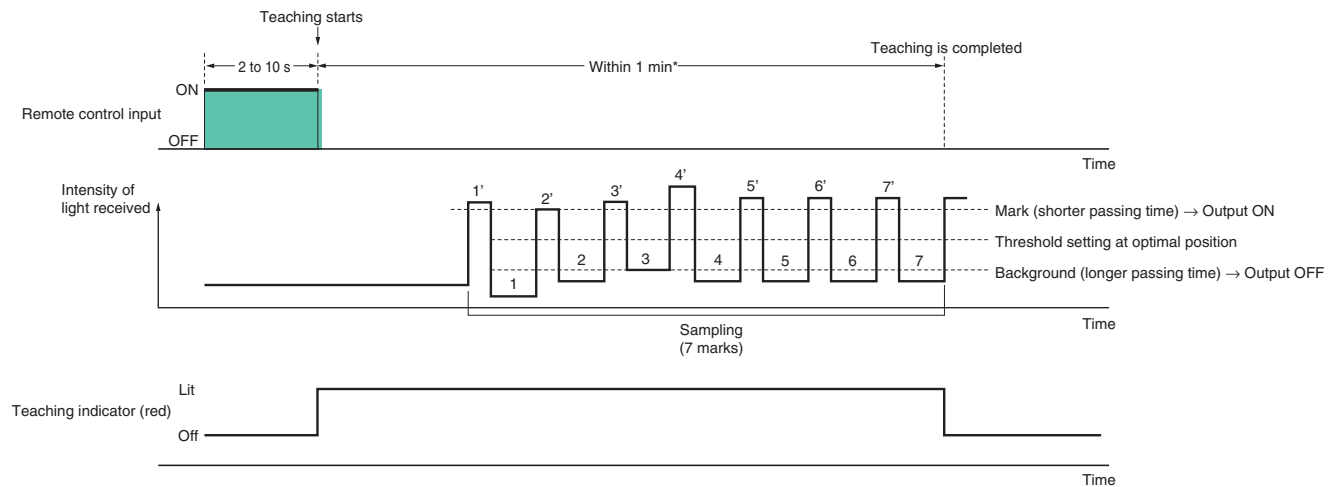

*If seven marks do not pass within one minute of the remote control input, the teaching operation will be cancelled.

Precautions for Using Automatic Teaching (Remote)

- With automatic teaching (remote), the output is always turned ON for the light level with the shorter detection time. Use 2-point teaching (manual) to turn OFF the output for the light level with the shorter detection time.
- Faulty detection is possible when using automatic teaching (remote) if there is considerable movement in the sensing object or if the surface of the object is stepped or contains protrusions. In cases such as these, use 2-point teaching.
- Do not use automatic teaching for backgrounds that are not monochrome.

Sensors

Mark Sensor (Diffuse reflective)

Pre-wired Models

E3ZM-V61

E3ZM-V81

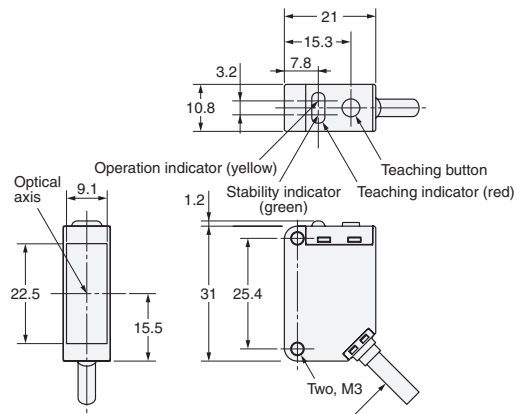

4-dia. Vinyl-insulated round cable with 4 conductors
(Conductor cross section: 0.2 mm² (AWG.24), Insulator diameter: 1.1 mm), Standard length: 2 m

Mark Sensor (Diffuse reflective)

M8 Connector

E3ZM-V66

E3ZM-V86

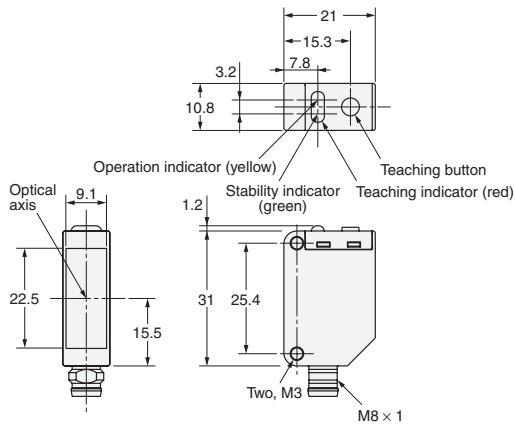



Washdown-Resistant Sensor Options

Omron provides a complete sensor offering to solve your toughest detection problems.

E3ZM

Detergent resistant photosensor.



Reduce replacement costs with E3ZM. It withstands years of high-pressure, high temperature washdown with harsh detergents and disinfectants used in meat processing and food packaging.

Through-beam: 15 m
Retroreflective: 4 m
Diffuse: 1 m
Background suppression:
10 to 100 mm; 10 to 150 mm;
10 to 200 mm

E3ZM-B

PET bottle detector.



Accurately detect PET bottles regardless of the wide variety of shapes and bottle geometries. Unique circuitry and optics prevent false signaling.

Polarized retroreflective
Sensing distance:
100 to 500 mm

E3ZM-C

Oil-resistant photosensor.



Compact sensor tolerates long exposure to cutting oils, coolants and lubricants used in automotive and machine tool applications. Visible spot simplifies alignment.

Through-beam: 15 m, 20 m
Retroreflective: 0.1 to 4 m
Diffuse: 1 m
Background suppression:
10 to 100 mm; 10 to 150 mm;
10 to 200 mm

E3ZM Standard Models (E3ZM-T/-R/-D/-LS) Ideal for the Food Industry, and Models for PET Bottle Detection (E3ZM-B).

Ratings and Specifications

Item	Sensing method	Through-beam		Retro-reflective with MSR function	Diffuse-reflective Models
	Model	NPN output	E3ZM-T61 E3ZM-T66	E3ZM-T63 E3ZM-T68	E3ZM-R61 E3ZM-R66
	PNP output	E3ZM-T81 E3ZM-T86	E3ZM-T83 E3ZM-T88	E3ZM-R81 E3ZM-R86	E3ZM-D82 E3ZM-D87
Sensing distance		15 m	0.8 m	4 m [100 mm] * (Using E39-R1S) 3 m [100 mm] * (Using E39-R1)	1 m (White paper 300 × 300 mm)
Spot diameter		---			
Standard sensing object		Opaque: 12-mm dia. min.	Opaque: 2-mm dia. min.	Opaque: 75-mm dia. min.	---
Differential travel		---			20% of sensing distance max.
Reflectivity characteristics (black/white error)		---			
Directional angle		Emitter, Receiver: 3° to 15°		Sensor: 3° to 10° Reflector: 30°	---
Light source (wavelength)		Infrared LED (870 nm)		Red LED (660 nm)	Infrared LED (860 nm)
Power supply voltage		10 to 30 VDC, including 10% ripple (p-p)			
Current consumption		40 mA max. (Emitter, Receiver: 20 mA max. each)		25 mA max.	
Control output		Load power supply voltage: 30 VDC max., Load current: 100 mA max. (Residual voltage: 2 V max.) Open-collector output (NPN/PNP output depending on model) Light-ON/Dark-ON switch selectable			
Protection circuits		Reversed power supply polarity protection, Output short-circuit protection, and Reversed output polarity protection		Reversed power supply polarity protection, Output short-circuit protection, Mutual interference prevention, and Reversed output polarity protection	
Response time		Operate or reset: 1 ms max.			
Sensitivity adjustment		One-turn adjuster			
Ambient illumination		(Receiver side) Incandescent lamp: 3,000 lx max., Sunlight: 10,000 lx max.			
Ambient temperature range		Operating: -25°C to 55°C, Storage: -40°C to 70°C (with no icing or condensation)			

* Values in brackets are the minimum required distance between the Sensor and Reflector.

Item	Sensing method	BGS Reflective Models			Models for PET Bottle Detection Retro-reflective (P-opaquin and MSR Function)
	Model	NPN output	E3ZM-LS61H E3ZM-LS66H	E3ZM-LS62H E3ZM-LS67H	E3ZM-LS64H E3ZM-LS69H
	PNP output	E3ZM-LS81H E3ZM-LS86H	E3ZM-LS82H E3ZM-LS87H	E3ZM-LS84H E3ZM-LS89H	E3ZM-B81 E3ZM-B86
Sensing distance		10 to 100 mm (White paper 100 × 100 mm)	10 to 150 mm (White paper 100 × 100 mm)	10 to 200 mm (White paper 100 × 100 mm)	100 to 500 mm (Using E39-RP1)
Spot diameter		4-mm dia. at sensing distance of 100 mm	12-mm dia. at sensing distance of 150 mm	18-mm dia. at sensing distance of 200 mm	---
Standard sensing object		---			Transparent round 500-ml PET bottles (65 mm dia.)
Differential travel		3% of sensing distance max.	15% of sensing distance max.	20% of sensing distance max.	---
Reflectivity characteristics (black/white error)		5% of sensing distance max.	10% of sensing distance max.	20% of sensing distance max.	---
Directional angle		---			Sensor: 3° to 10° Reflector: 30°
Light source (wavelength)		Red LED (650 nm)	Red LED (660 nm)		Red LED (650 nm)
Power supply voltage		10 to 30 VDC, including 10% ripple (p-p)			
Current consumption/ power consumption		25 mA max.			450 mW max.
Control output		Load power supply voltage: 30 VDC max., Load current: 100 mA max. (Residual voltage: 2 V max.) Open-collector output (NPN/PNP output depending on model) Light-ON/Dark-ON cable connection selectable			
Protection circuits		Reversed power supply polarity protection, Output short-circuit protection, Mutual interference prevention, and Reversed output polarity protection			
Response time		Operate or reset: 1 ms max.			
Sensitivity adjustment		---			Adjusted by teaching
Ambient illumination		(Receiver side) Incandescent lamp: 3,000 lx max., Sunlight: 10,000 lx max.			
Ambient temperature range		Operating: -25°C to 55°C, Storage: -40°C to 70°C (with no icing or condensation)			Operating: -40°C to 60°C, Storage: -40°C to 70°C (with no icing or condensation)

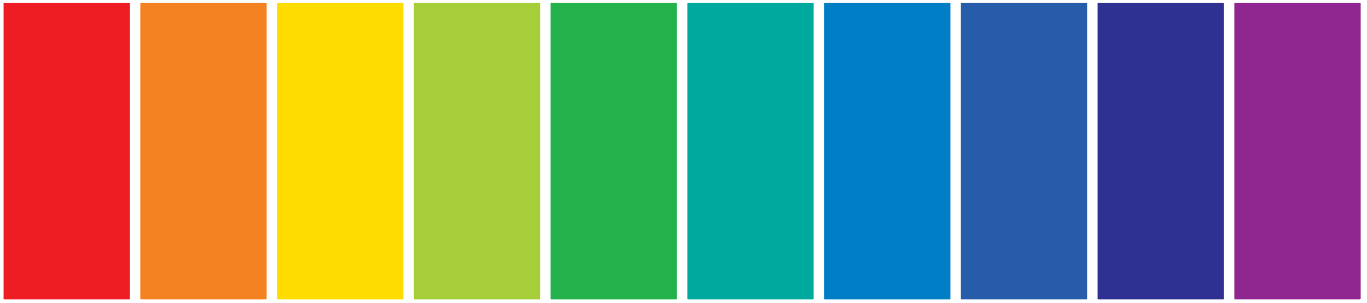

Use this color chart to demonstrate the E3ZM-V Color Mark Sensor.

OMRON

OMRON ELECTRONICS LLC • THE AMERICAS HEADQUARTERS
Schaumburg, IL USA • 847.843.7900 • 800.556.6766 • www.omron247.com

OMRON CANADA, INC. • HEAD OFFICE
Toronto, ON, Canada • 416.286.6465 • 866.986.6766 • www.omron.ca

OMRON ELETRÔNICA DO BRASIL LTDA • HEAD OFFICE
São Paulo, SP, Brasil • 55.11.2101.6300 • www.omron.com.br

OMRON ELECTRONICS MEXICO SA DE CV • HEAD OFFICE
Apodaca, N.L. • 52.811.156.99.10 • 001.800.556.6766 • mela@omron.com

OMRON ARGENTINA • SALES OFFICE
Cono Sur • 54.11.4783.5300

OMRON CHILE • SALES OFFICE
Santiago 56.9.9917.3920

OTHER OMRON LATIN AMERICA SALES
54.11.4783.5300