

Compact, Economical Plug-in Type Voltage Sensing Relay

- DPDT output contacts expand the application of the Sensor to wide-ranging fields including control, alarms, and indication.
- Voltage control is possible in the same easy manner as electro-magnetic relays, as the output relay of the sensor can be driven directly with a detection signal.
- Wide voltage setting range with fine setting capability.



Model Number Structure

Model Number Legend

LG2-□□

1 2 3

1. Voltage sensor

2, 3. Operating Voltage

AB: 100, 110, 200 VAC

DB: 12, 24, 48, 100 VDC

Ordering Information

List of Models

Detected voltage	Model
AC	LG2-AB (100 VAC) LG2-AB (200 VAC) LG2-AB (110 VAC)
DC	LG2-DB (12 VDC) LG2-DB (24 VDC) LG2-DB (48 VDC) LG2-DB (100 VDC)

Connecting Socket

Socket		Bracket
Type	Model	Model
Front-mounting socket	PF083A	PFC-A7
Back-mounting socket	PL08	PLC-8

Note: Use the above sockets to mount the Voltage Sensor securely and prevent problems, such as faulty contact.

Specifications

■ Ratings

Item	Detected voltage	Load Power/VA consumption	Setting range		Rated carry current	Control output		
	Rated voltage		Must-operate (SET) voltage (percentage of rated value)	Must-release (RESET) voltage (percentage of rated value)		Switching capacity		
						Rated operating voltage	Rated operating current	
Model							Resistive load ($\cos\phi = 1$)	Inductive load ($\cos\phi = 0.4$, L/R = 7 ms)
LG2-AB	100 VAC 200 VAC 50/60 Hz	5 VA max.	75% to 120%	70% to 115%	5 A	100 VAC 200 VAC 28 VDC 110 VDC	5 A 2 A 5 A 0.2 A	3 A 1.2 A 2 A 0.1 A
	110 VAC 50/60 Hz		80% to 110%	75% to 105%				
LG2-DB	12 VDC 24 VDC 48 VDC 100 VDC	3 W max.	75% to 120%	70% to 115%				

- Note:**
1. Set the must-operate voltage higher than the must-release voltage by at least 5% of the rated value.
 2. Smoothing is required for the detected DC voltage.
 3. The maximum applied voltage is 120% of the rated value.
 4. Special models enabling a rated voltage of 220 V are available. The setting range for these models is 80% to 110%.

■ Characteristics

Repeat accuracy	±3% max. (with voltage fluctuations at the rate of 1 V/s)
Variation due to temperature change	±5% max. (within the range 20 °C +20/-30 °C)
Operate time	0.5 s max. (when input changes from 0 V to 120% must-operate voltage)
Release time	0.5 s max. (when input changes from 120% of the must-release voltage to 0 V)
Insulation resistance	10 MΩ min. at 500 VDC (between electric circuitry and mounting panel)
Dielectric strength	2,000 VAC, 50/60 Hz for 1 min (between electric circuitry and mounting panel)
Vibration	Malfunction: 16.7 Hz, 1-mm double amplitude
Shock	Destruction: 294 m/s ² (approx. 30 G)
Service life	Mechanically: 10,000,000 operations min. Electrically: 50,000 operations min. (at max. applicable load)
Weight	Approx. 100 g
Ambient operating temperature	-10 to 40°C (with no condensation)

Connections

Terminal Arrangement

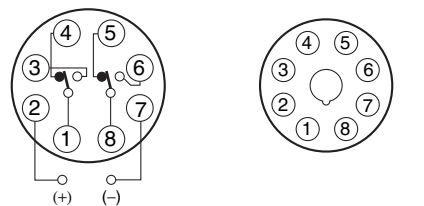

The polarity indication for terminals ② and ⑦ applies to the DC model (LG2-DB). (The above diagram shows the rear side of the Relay.)

(The above diagram shows the rear side of the Relay.)

- Note:**
- *Type LG2-DB is not equipped with the rectifier circuit.
 - With type LG2-DB, care should be taken to the polarity of the power supply.

Nomenclature

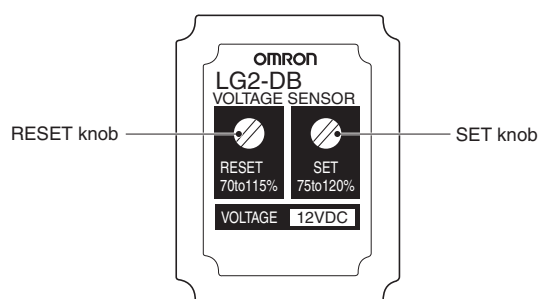

Setting Method

Operate Value

Input the actual voltage to be set, and set the SET knob to the point at which the Relay operates.

Release Value

- With the Relay operating, turn the RESET knob counterclockwise as far as it will go, and adjust the voltage to the value to be set. Then, gradually turn the RESET knob clockwise until it reaches the point where the Relay is released.

Note: After completing the settings, check the settings for the operate and release values by increasing/decreasing the input voltage.

- The LG2 can be used for undervoltage detection by using the RESET knob for the operate value and the SET knob for the release value. The Relay will normally be ON, however, and so the internal temperature will rise, and this will affect the product service life.

Dimensions

Note: All units are in millimeters unless otherwise indicated.

LG2-AB, LG2-DB

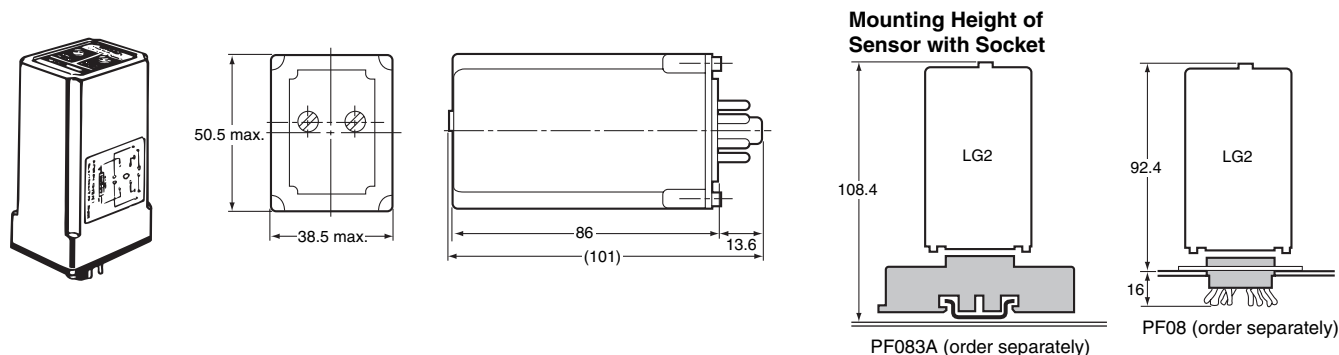

Accessories (Order Separately)

Connecting Socket

PF083A Front Connecting Socket

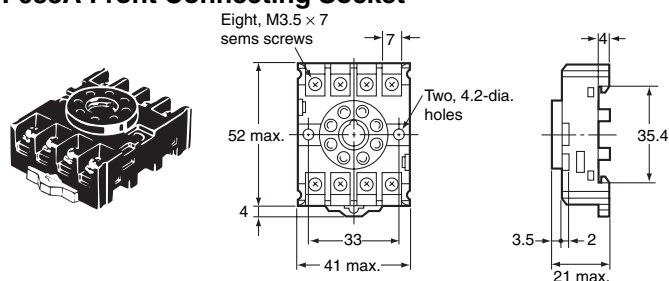

Terminal Arrangement

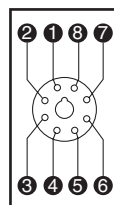

(Top View)

Mounting Holes

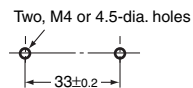

Note: Mount sockets to applicable models so that points downwards.

Applicable Models
APR-S
LG2

PL08 Back Connecting Socket (Solder Terminals)

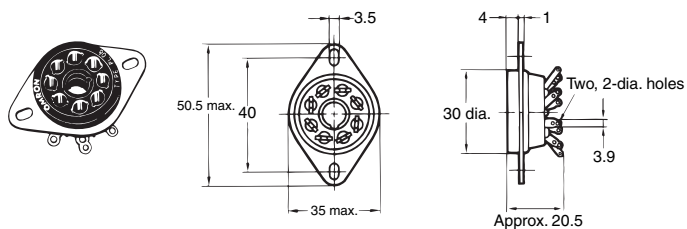

Terminal Arrangement

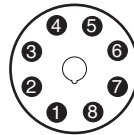

(Top View)

Mounting Holes

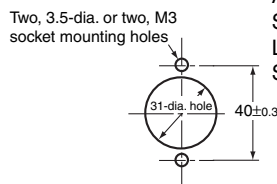

Applicable Models
SE
APR-S
SDV
LG2
SAO

Socket Mounting Track (for PF083A)

PF083A/PFP-50N Socket Mounting Track

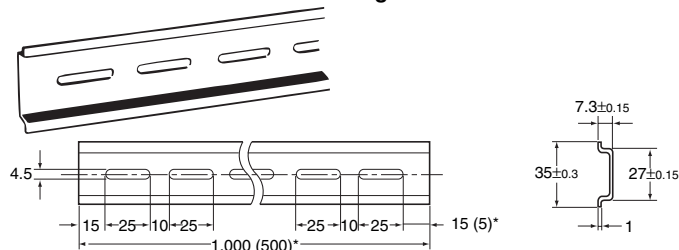

* The dimensions given in parentheses are for the PFP-50N Socket Mounting Track.

Hold-down Clip

Use the Hold-down Clip to secure the Voltage Sensor on the Connecting Socket, as well as to prevent faulty contact.

Type of Socket	Applicable type of Hold-down Clip
PF083A	PFC-A7
PL08	PLC-8

ALL DIMENSIONS SHOWN ARE IN MILLIMETERS.
To convert millimeters into inches, multiply by 0.03937. To convert grams into ounces, multiply by 0.03527.

In the interest of product improvement, specifications are subject to change without notice.

Read and Understand This Catalog

Please read and understand this catalog before purchasing the products. Please consult your OMRON representative if you have any questions or comments.

Warranty and Limitations of Liability

WARRANTY

OMRON's exclusive warranty is that the products are free from defects in materials and workmanship for a period of one year (or other period if specified) from date of sale by OMRON.

OMRON MAKES NO WARRANTY OR REPRESENTATION, EXPRESS OR IMPLIED, REGARDING NON-INFRINGEMENT, MERCHANTABILITY, OR FITNESS FOR PARTICULAR PURPOSE OF THE PRODUCTS. ANY BUYER OR USER ACKNOWLEDGES THAT THE BUYER OR USER ALONE HAS DETERMINED THAT THE PRODUCTS WILL SUITABLY MEET THE REQUIREMENTS OF THEIR INTENDED USE. OMRON DISCLAIMS ALL OTHER WARRANTIES, EXPRESS OR IMPLIED.

LIMITATIONS OF LIABILITY

OMRON SHALL NOT BE RESPONSIBLE FOR SPECIAL, INDIRECT, OR CONSEQUENTIAL DAMAGES, LOSS OF PROFITS OR COMMERCIAL LOSS IN ANY WAY CONNECTED WITH THE PRODUCTS, WHETHER SUCH CLAIM IS BASED ON CONTRACT, WARRANTY, NEGLIGENCE, OR STRICT LIABILITY.

In no event shall the responsibility of OMRON for any act exceed the individual price of the product on which liability is asserted.

IN NO EVENT SHALL OMRON BE RESPONSIBLE FOR WARRANTY, REPAIR, OR OTHER CLAIMS REGARDING THE PRODUCTS UNLESS OMRON'S ANALYSIS CONFIRMS THAT THE PRODUCTS WERE PROPERLY HANDLED, STORED, INSTALLED, AND MAINTAINED AND NOT SUBJECT TO CONTAMINATION, ABUSE, MISUSE, OR INAPPROPRIATE MODIFICATION OR REPAIR.

Application Considerations

SUITABILITY FOR USE

OMRON shall not be responsible for conformity with any standards, codes, or regulations that apply to the combination of products in the customer's application or use of the products.

At the customer's request, OMRON will provide applicable third party certification documents identifying ratings and limitations of use that apply to the products. This information by itself is not sufficient for a complete determination of the suitability of the products in combination with the end product, machine, system, or other application or use.

The following are some examples of applications for which particular attention must be given. This is not intended to be an exhaustive list of all possible uses of the products, nor is it intended to imply that the uses listed may be suitable for the products:

- Outdoor use, uses involving potential chemical contamination or electrical interference, or conditions or uses not described in this catalog.
- Nuclear energy control systems, combustion systems, railroad systems, aviation systems, medical equipment, amusement machines, vehicles, safety equipment, and installations subject to separate industry or government regulations.
- Systems, machines, and equipment that could present a risk to life or property.

Please know and observe all prohibitions of use applicable to the products.

NEVER USE THE PRODUCTS FOR AN APPLICATION INVOLVING SERIOUS RISK TO LIFE OR PROPERTY WITHOUT ENSURING THAT THE SYSTEM AS A WHOLE HAS BEEN DESIGNED TO ADDRESS THE RISKS, AND THAT THE OMRON PRODUCTS ARE PROPERLY RATED AND INSTALLED FOR THE INTENDED USE WITHIN THE OVERALL EQUIPMENT OR SYSTEM.

PROGRAMMABLE PRODUCTS

OMRON shall not be responsible for the user's programming of a programmable product, or any consequence thereof.

Disclaimers

CHANGE IN SPECIFICATIONS

Product specifications and accessories may be changed at any time based on improvements and other reasons.

It is our practice to change model numbers when published ratings or features are changed, or when significant construction changes are made. However, some specifications of the products may be changed without any notice. When in doubt, special model numbers may be assigned to fix or establish key specifications for your application on your request. Please consult with your OMRON representative at any time to confirm actual specifications of purchased products.

DIMENSIONS AND WEIGHTS

Dimensions and weights are nominal and are not to be used for manufacturing purposes, even when tolerances are shown.

PERFORMANCE DATA

Performance data given in this catalog is provided as a guide for the user in determining suitability and does not constitute a warranty. It may represent the result of OMRON's test conditions, and the users must correlate it to actual application requirements. Actual performance is subject to the OMRON Warranty and Limitations of Liability.

ERRORS AND OMISSIONS

The information in this document has been carefully checked and is believed to be accurate; however, no responsibility is assumed for clerical, typographical, or proofreading errors, or omissions.

2013.3

In the interest of product improvement, specifications are subject to change without notice.

OMRON Corporation
Industrial Automation Company

<http://www.ia.omron.com/>

(c)Copyright OMRON Corporation 2013 All Right Reserved.