

Programmable Digital Controller E5AR-T

CSM_E5AR-T_DS_E_3_2

A new High-speed, High-precision Digital Controller that is Programmable!

- Create up to 32 programs with up to 256 segments total.
- Coordinated operation for up to four channels with one Digital Controller.
- 0.01°C High resolution for Pt input.
- High-speed sampling at 50 ms.
- Settings easily made from a computer using the CX-Thermo.
- RoHS compliance for world-wide application.



Refer to *Safety Precautions for All E5□R Models.*

For the most recent information on models that have been certified for safety standards, refer to your OMRON website.

Model Number Structure

Model Number Legend

E5AR-T□□□□□□□□-□□□□
1 2 3 4 5 6 7 8 9

1. Control method

Blank: Standard or heating/cooling control
P: Position proportional control

2. Output 1

R: NO relay output + NO relay output
Q: Pulse output/current output + pulse output
C: Current output + current output

3. Output 2

R: NO relay output + NO relay output
Q: Pulse output/current output + pulse output
C: Current output + current output

4. Auxiliary Outputs

Blank: None
4: NO relay output + NO relay output
E: 5 transistor outputs + 5 transistor outputs

5. Communications

Blank: None
3: RS-485 communications

6. Optional function

Blank: None
D: 4 event inputs
M: 4 event inputs + 4 event inputs

7. Input 1

B: Universal-input and 2 event inputs
F: Universal-input and FB
W: Universal-input and universal-input

8. Input 2

Blank: None
W: Universal-input and universal-input

9. Other

FLK: CompoWay/F communications

Note: The above model number legend is intended as a functional description of models. Not all possible combinations of functions are available. Confirm model availability in *Ordering Information* when ordering.

Note: Be sure to read the precautions for correct use and other precautions in the following user's manual before using the Digital Controller.
E5AR/ER Digital Controller User's Manual (Cat. No. Z182)

Ordering Information

■ Digital Controllers

Programmable Digital Controllers

Size	Control type	Control mode	Outputs (control/transfer)	Optional functions			Model
				Auxiliary outputs (SUB)	Event inputs	Serial communi- cations	
96 × 96 mm	Basic control (1 loop)	Standard control Heating and cooling control	2 (pulse + pulse/current)	4	2	None	E5AR-TQ4B
			2 (current + current)				E5AR-TC4B
			2 (pulse + pulse/current)				RS-485
			2 (current + current)	E5AR-TC43B-FLK (See note 2.)			
			2 (pulse + pulse/current)	10 (See note 3.)	10	E5AR-TQE3MB-FLK (See note 2.)	
			2 (current + current)			E5AR-TCE3MB-FLK (See note 2.)	
	4 (pulse + pulse/current + 2 current)	E5AR-TQCE3MB-FLK					
	2-loop control	2-loop standard control Single-loop heating and cooling control Single-loop cascade control Single-loop control with remote SP Single-loop proportional control	2 (pulse + pulse/current)	4	4	RS-485	E5AR-TQ43DW-FLK (See note 2.)
			2 (current + current)				E5AR-TC43DW-FLK (See note 2.)
			4 (2 pulse + pulse/2 current)	10 (See note 3.)	8	E5AR-TQCE3MWW-FLK	
	4-loop control	4-loop standard control 2-loop heating and cooling control (See note 4.)	4 (4 current)	10 (See note 3.)	8	RS-485	E5AR-TCCE3MWW-FLK
			4 (2 pulse + pulse/2 current)				E5AR-TQCE3MWW-FLK (See note 2.)
Control valve control (1 loop)	Single-loop position-proportional control	Relay outputs (1 open, 1 closed)	4	4	None	E5AR-TPR4DF	
		Relay outputs (1 open, 1 closed) and 1 current	10 (See note 3.)	8	RS-485	E5AR-TPRQE3MF-FLK	

Note 1: Specify the power supply specifications when ordering. Model numbers for 100 to 240 VAC are different from those for 24 VAC/VDC.

2: These models are for 100 to 240 VAC only.

3: The outputs are transistor output.

4: Only for coordinated operation. (A separate program cannot be set for each channel.)

Inspection Results

If an inspection report is required, it can be ordered at the same time as the Digital Controller using the following model number.

Inspection Report (Order Separately)

Model
E5AR-K

■ Accessories (Order Separately)

Terminal Cover

Descriptions	Model
Terminal Cover for E5AR	E53-COV14

Unit Label Sheet

Model
Y92S-L1

Rubber Packing

Model
Y92S-P4

Note: The Rubber Packing is provided with the Digital Controller.

Specifications



■ Ratings

Supply voltage (See note 2.)	CE marking	100 to 240 VAC, 50/60 Hz	24 VAC, 50/60 Hz; 24 VDC
	UL certification	100 to 120 VAC, 50/60 Hz	
Operating voltage range		85% to 110% of rated supply voltage	
Power consumption		22 VA max. (with maximum load)	15 VA/10 W max. (with maximum load)
Sensor input (See note 3.)		Thermocouple: K, J, T, E, L, U, N, R, S, B, W Platinum resistance thermometer: Pt100 Current input: 4 to 20 mA DC, 0 to 20 mA DC (including remote SP input) Voltage input: 1 to 5 VDC, 0 to 5 VDC, 0 to 10 VDC (including remote SP input) (Input impedance: 150 Ω for current input, approx. 1 MΩ for voltage input)	
Control output	Voltage (pulse) output	12 VDC, 40 mA max. with short-circuit protection circuit (E5AR-TQQE3MW-FLK: 21 mA max.)	
	Current output	0 to 20 mA DC, 4 to 20 mA DC; load: 500 Ω max. (including transfer output) (Resolution: Approx. 54,000 for 0 to 20 mA DC; Approx. 43,000 for 4 to 20 mA DC)	
	Relay output	Position-proportional control type (open, closed) N.O., 250 VAC, 1 A (including inrush current)	
Auxiliary output		Relay Output N.O., 250 VAC, 1 A (resistive load) Transistor Output Maximum load voltage: 30 VDC; Maximum load current: 50 mA; Residual voltage: 1.5 V max.; Leakage current: 0.4 mA max.	
Potentiometer input		100 Ω to 2.5 kΩ	
Event input	Contact	Input ON: 1 kΩ max.; OFF: 100 kΩ min.	
	No-contact	Input ON: Residual voltage of 1.5 V max.; OFF: Leakage current of 0.1 mA max. Short-circuit: Approx. 4 mA	
Remote SP input		Refer to the information on sensor input.	
Transfer output		Refer to the information on control output.	
Control method		2-PID or ON/OFF control	
Setting method		Digital setting using front panel keys or setting using serial communications	
Indication method		7-segment digital display and single-lighting indicator Character Height PV display: 12.8 mm; SV display: 7.7 mm; MV display: 7.7 mm	
Other functions		Depends on model.	
Ambient operating temperature		-10 to 55°C (with no icing or condensation) For 3 years of assured use: -10 to 50°C (with no icing or condensation)	
Ambient operating humidity		25% to 85%	
Storage temperature		-25 to 65°C (with no icing or condensation)	

- Note 1:** Do not use an inverter output as the power supply. (Refer to *Safety Precautions for All E5LR Models*.)
Note 2: The supply voltage (i.e., 100 to 240 VAC or 24 VAC/VDC) depends on the model. Be sure to specify the required type when ordering.
Note 3: The Controller is equipped with multiple sensor input. Temperature input or analog input can be selected with the input type setting switch. There is basic insulation between power supply and input terminals, power supply and output terminals, and input and output terminals.

■ Input Ranges

Platinum Resistance Thermometer, Thermocouple, Current, or Voltage Input

Input type	Platinum resistance thermometer	Thermocouple														Current		Voltage			
		Pt100														mA		V			
Name	Pt100	K	J	T	E	L	U	N	R	S	B	W (W/Re 5-26)									
Temperature range (°C)	2300																				
	1800																				
Temperature range (°C)	1300																				
	900																				
	800																				
	700																				
	600																				
	500																				
	400																				
	300																				
	200																				
	100																				
	0																				
	-100																				
	-200																				
	Setting	0	1	2	3	4	5	6	7	8	9	10	11	12	13	14	15	16	17	18	19
Minimum setting unit (SP and alarm)	0.1°C	0.01°C	0.1°C														(Depends on scaling and number of decimal places.)				
Input type setting switch	Set to TC.PT. 														Set to ANALOG 						

Note: The shaded area indicates the setting status at the time of purchase.

■ Characteristics

Indication accuracy	Thermocouple input with cold junction compensation: ($\pm 0.1\%$ of PV or $\pm 1^\circ\text{C}$, whichever is greater) ± 1 digit max. (See note 1.) Thermocouple input without cold junction compensation: ($\pm 0.1\%$ FS or $\pm 1^\circ\text{C}$, whichever is smaller) ± 1 digit (See note 2.) Analog input: $\pm 0.1\%$ FS ± 1 digit max. Platinum resistance thermometer input: ($\pm 0.1\%$ of PV or $\pm 0.5^\circ\text{C}$, whichever is greater) ± 1 digit max. Position-proportional potentiometer input: $\pm 5\%$ FS ± 1 digit max.
Control mode	Standard control (heating or cooling control), heating/cooling control, standard control with remote SP (2-input models only), heating/cooling control with remote SP (2-input models only), cascade standard control (2-input models only), cascade heating/cooling control (2-input models only), proportional control (2-input models only), position-proportional control (control-valve control models only)
Influence of temperature	Thermocouple input (R, S, B, W): ($\pm 1\%$ of PV or $\pm 10^\circ\text{C}$, whichever is greater) ± 1 digit max. Other thermocouple input: ($\pm 1\%$ of PV or $\pm 4^\circ\text{C}$, whichever is greater) ± 1 digit max. *K thermocouple at -100°C max.: $\pm 10^\circ\text{C}$ max. Platinum resistance thermometer: ($\pm 1\%$ of PV or $\pm 2^\circ\text{C}$, whichever is greater) ± 1 digit max. Analog input: ($\pm 1\%$ FS) ± 1 digit max.
Influence of voltage	
Control period	0.2 to 99.0 s (in units of 0.1 s) for time-proportioning control output
Proportional band (P)	0.00% to 999.99% FS (in units of 0.01% FS)
Integral time (I)	0.0 to 3,999.9 s (in units of 0.1 s)
Derivative time (D)	0.0 to 3,999.9 s (in units of 0.1 s)
Hysteresis	0.01% to 99.99% FS (in units of 0.01% FS)
Manual reset value	0.0% to 100.0% (in units of 0.1% FS)
Alarm setting range	-19,999 to 99,999 EU (See note 3.) (The decimal point position depends on the input type and the decimal point position setting.)
Input sampling period	50 ms
Insulation resistance	20 M Ω min. (at 500 VDC)
Dielectric strength	2,000 VAC, 50/60 Hz for 1 min (between charged terminals of different polarities)
Vibration resistance (malfunction)	10 to 55 Hz, 20 m/s ² for 10 min each in X, Y, and Z directions
Shock resistance (malfunction)	100 m/s ² , 3 times each in X, Y, and Z directions
Inrush current	100 to 240-VAC models: 50 A max. 24 VAC/VDC models: 30 A max.
Weight	Controller only: Approx. 450 g; Mounting bracket: Approx. 60 g; Terminal cover: Approx. 30 g
Degree of protection	Front panel: NEMA4X for indoor use; Rear case: IP20; Terminals: IP00
Memory protection	Non-volatile memory (number of writes: 100,000)
Applicable standards	UL 61010C-1, CSA C22.2 No. 1010-1 (Power supply voltage: 100 to 120 VAC); Pollution degree 2/Overvoltage category 2 EN 61010-1 (IEC 61010-1) (Power supply voltage: 100 to 240 VAC); Pollution degree 2/Overvoltage category 2
EMC	EMI: EN61326 Radiated Interference Electromagnetic Field Strength: EN55011 Group 1 Class A Noise Terminal Voltage: EN55011 Group 1 Class A EMS: EN61326 ESD Immunity: EN61000-4-2: 4 kV contact discharge (level 2) 8 kV air discharge (level 3) Electromagnetic Immunity: EN61000-4-3: 10 V/m (amplitude-modulated, 80 MHz to 1 GHz, 1.4 GHz to 2 GHz) (level 3) EN61000-4-4: 2 kV power line (level 3) 2 kV output line (relay output) (level 4) Burst Noise Immunity: 1 kV measurement line, I/O signal line (level 4) 1 kV communications line (level 3) Conducted Disturbance Immunity: EN61000-4-6: 3 V (0.15 to 80 MHz) (level 3) Surge Immunity: EN61000-4-5: 1 kV line to line (power line, output line (relay output)) (level 2) 2 kV line to ground (power line, output line (relay output)) (level 3) Power Frequency Magnetic Field Immunity: EN61000-4-8: 30 A/m (50 Hz) continuous field Voltage Dip/Interrupting Immunity: EN61000-4-11: 0.5 cycle, 100% (rated voltage)

Note 1: K-, T-, or N-type thermocouple at -100°C max.: $\pm 2^\circ\text{C}$ ± 1 digit max.
U- or L-type thermocouple: $\pm 2^\circ\text{C}$ ± 1 digit max.
B-type thermocouple at 400°C max.: No accuracy specification.
R- or S-type thermocouple at 200°C max.: $\pm 3^\circ\text{C}$ ± 1 digit max.
W-type thermocouple: ($\pm 0.3\%$ of PV or $\pm 3^\circ\text{C}$, whichever is greater) ± 1 digit max.

2: U- or L-type thermocouple: $\pm 1^\circ\text{C}$ ± 1 digit

R- or S-type thermocouple at 200°C max.: $\pm 1.5^\circ\text{C}$ ± 1 digit

3: "EU" (Engineering Unit) represents the unit after scaling. If a temperature sensor is used, it is either $^\circ\text{C}$ or $^\circ\text{F}$.

■ Communications Specifications

Transmission path connection	Multiple points
Communications method	RS-485 (two-wire, half duplex)
Synchronization method	Start-stop synchronization
Baud rate	9,600, 19,200, or 38,400 bps
Transmission code	ASCII
Data bit length	7 or 8 bits
Stop bit length	1 or 2 bits
Error detection	Vertical parity (none, even, odd) Block check character (BCC): CompoWay/F CRC-16: Modbus
Flow control	None
Interface	RS-485
Retry function	None
Communications buffer	217 bytes
Communications response send wait time	0 to 99 ms, Default: 20 ms

■ Program Control Functions

Number of programs (patterns)	32 (with 8 segments/program)	
Number of segments (steps)	32 (with 8 programs)	
Maximum number of segments	256	
Segment setting method	Time setting (Segment set with set point and time.) Gradient setting (Segment set with set point, gradient, and time.)	
Segment times	0 h 0 min to 99 h 59 min 0 min 0 s to 99 min 59 s 0 min 00.0 s to 99 min 59.9 s	
Alarm group number specifications	Number of groups	4
	Setting method	Set separately for each program.
Reset operation	Select either stopping control or fixed SP operation.	
Startup operation	Select continuing, resetting, manual operation, run mode, or ramp back operation.	
PID sets	Number of sets	8
	Setting method	Set separately for each program (automatic PID group selection also supported).
Alarm SP function	Select from ramp SP and target SP.	
Program status control	Segment operation	Advance, hold, and back
	Program operation	Program repetitions and program links
Wait operation	Wait method	Select from waiting at segment ends and always waiting.
	Wait width setting	Wait width upper limit and lower limit set separately for each program.
	Setting method	ON/OFF setting for each segment
Time signals	Number of outputs	6
	Number of ON/OFF operations	3 each per output
	Setting method	Set separately for each program.
Segment outputs	Number of outputs	10
	Setting method	ON/OFF set for each segment.
Program status output	Program end output (pulse width can be set) Segment number output	
Program startup operation	PV start	Select from segment 1 set point, slope-priority PV start, and time-priority PV start.
	Standby	Standby
Operation end operation	Select from resetting, continuing control at final set point, and fixed SP control.	
Number of event inputs	10 max.	

Wiring Terminals

E5AR-T (Programmable Type)

E5AR-TQ4B

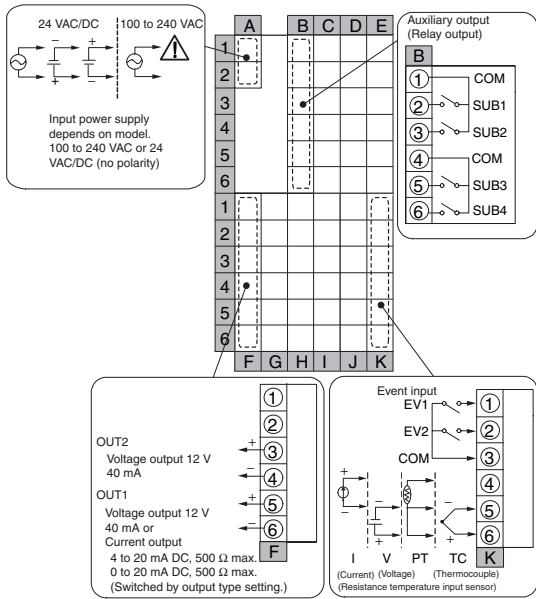

E5AR-TC4B

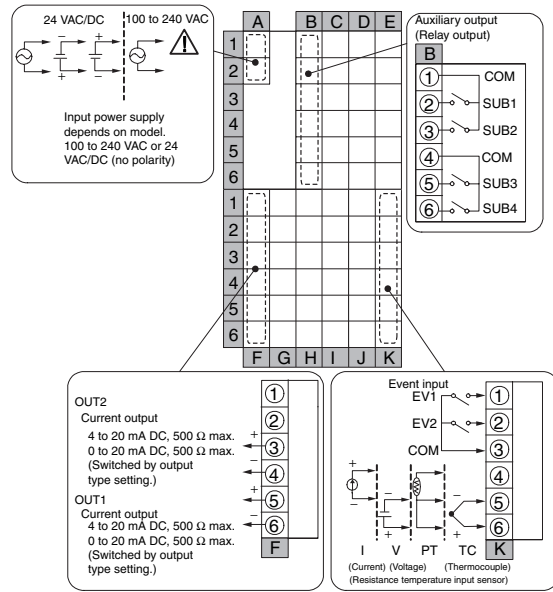

E5AR-TQ43B-FLK

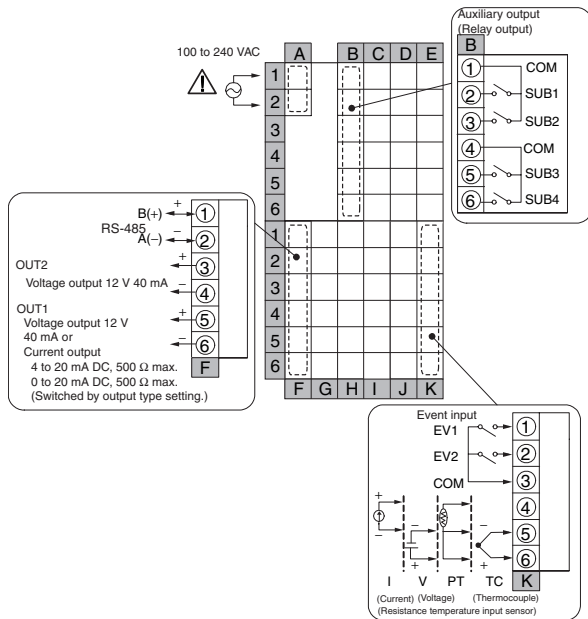

E5AR-TC43B-FLK

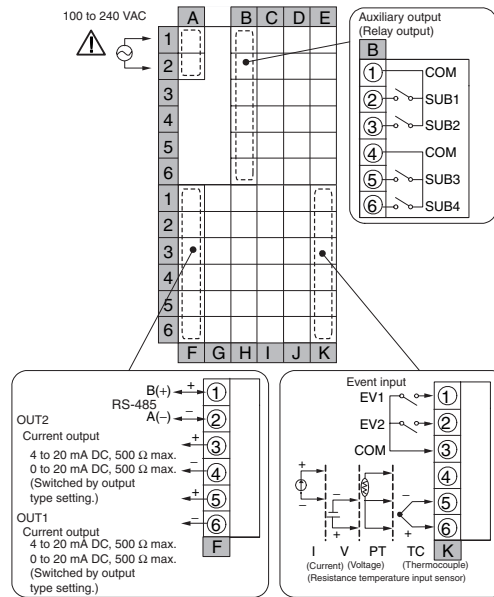

Note The power supply voltage must be 100 to 240 VAC or 24 VAC/DC for the E5AR-T to comply with CE marking requirements.
The power supply voltage must be 100 to 120 VAC or 24 VAC/DC for the E5AR-T to comply with UL requirements.

E5AR-TQE3MB-FLK

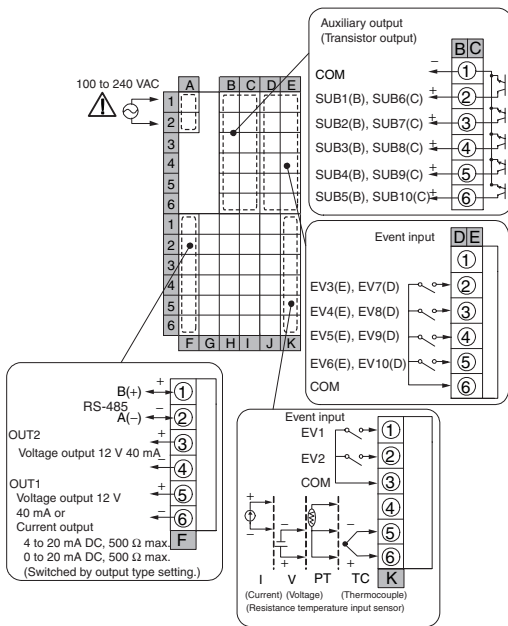

E5AR-TCE3MB-FLK

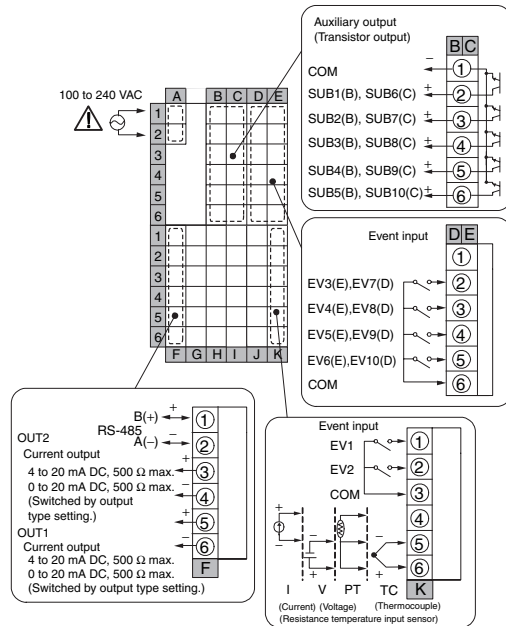

E5AR-TQCE3MB-FLK

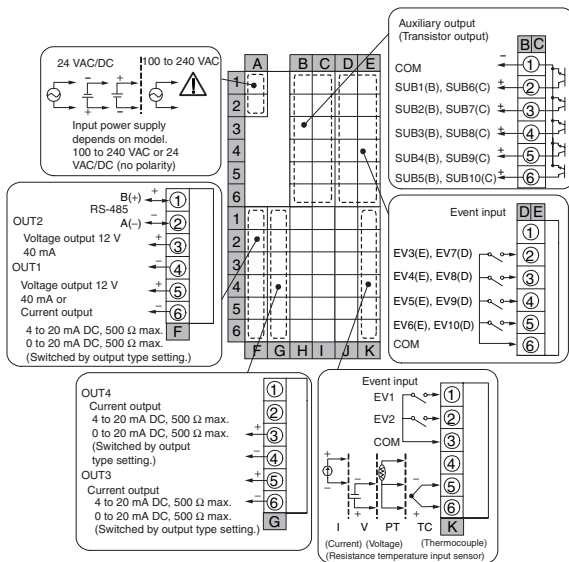

Note

The power supply voltage must be 100 to 240 VAC or 24 VAC/DC for the E5AR-T to comply with CE marking requirements.
The power supply voltage must be 100 to 120 VAC or 24 VAC/DC for the E5AR-T to comply with UL requirements.

E5AR-TQ43DW-FLK (2-loop Control)

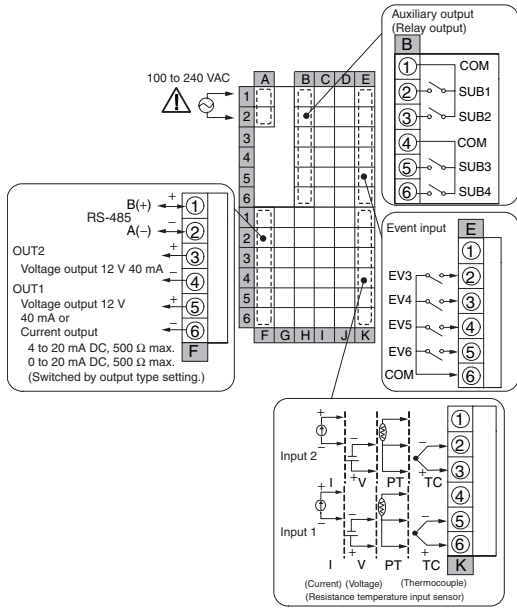

E5AR-TC43DW-FLK (2-loop Control)

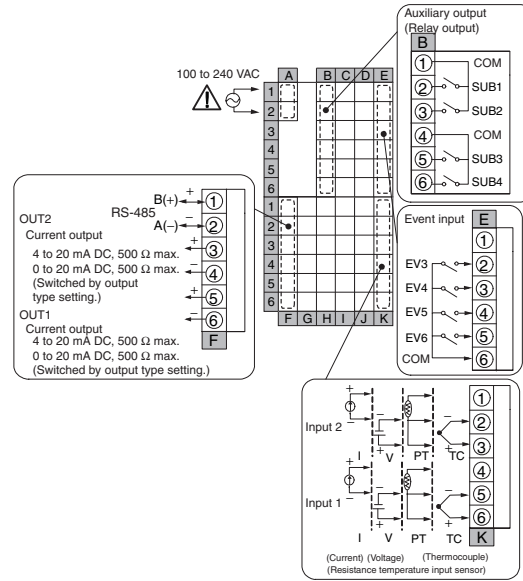

E5AR-TQQE3MW-FLK (2-loop Control)

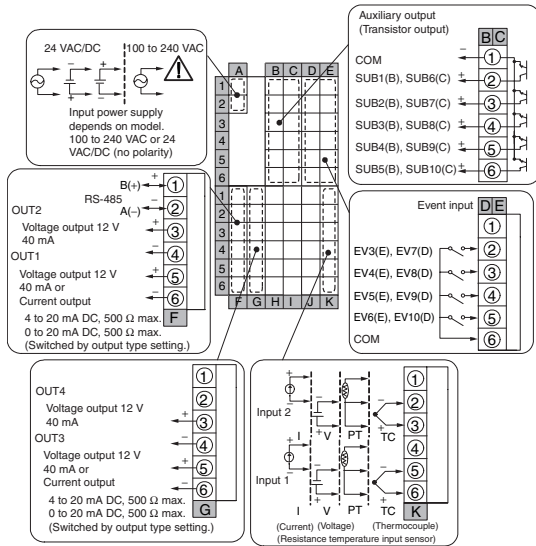

Note

The power supply voltage must be 100 to 240 VAC or 24 VAC/DC for the E5AR-T to comply with CE marking requirements.
The power supply voltage must be 100 to 120 VAC or 24 VAC/DC for the E5AR-T to comply with UL requirements.

E5AR-TCCE3MWW-FLK (4-loop Control)

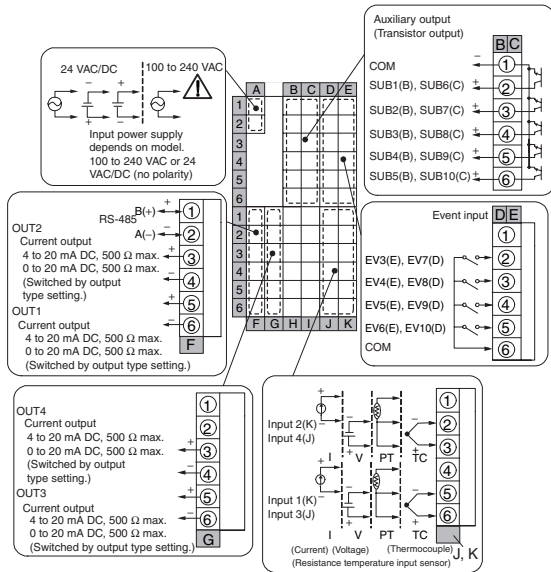

E5AR-TQQE3MWW-FLK (4-loop Control)

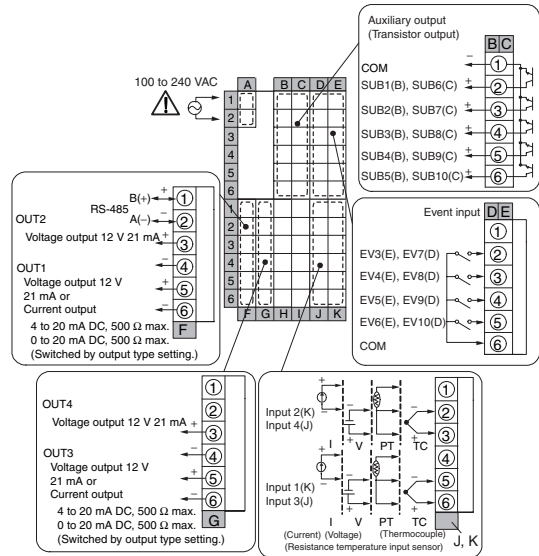

E5AR-TPR4DF

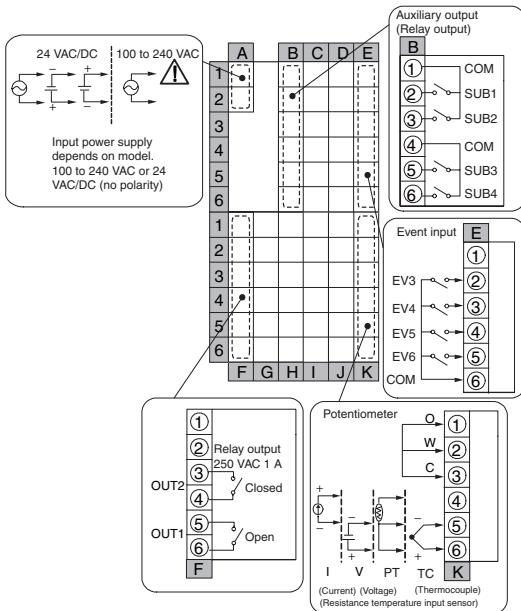

E5AR-TPRQE3MF-FLK

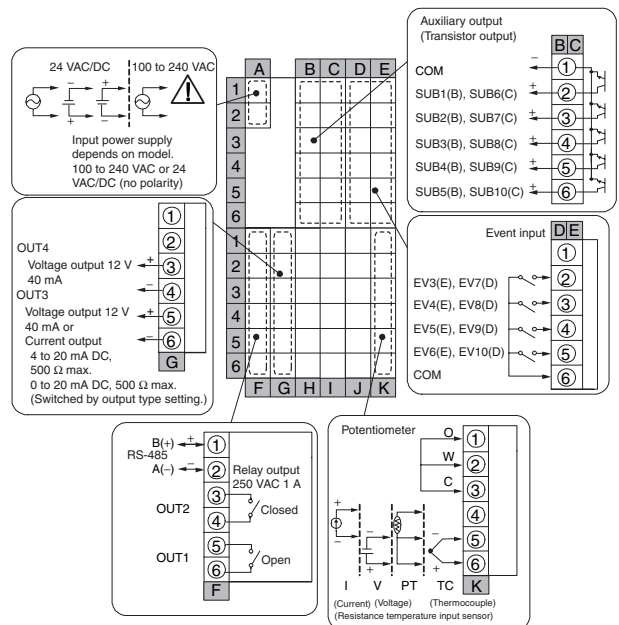

Note

The power supply voltage must be 100 to 240 VAC or 24 VAC/DC for the E5AR-T to comply with CE marking requirements.

The power supply voltage must be 100 to 120 VAC or 24 VAC/DC for the E5AR-T to comply with UL requirements.

Nomenclature

E5AR-T

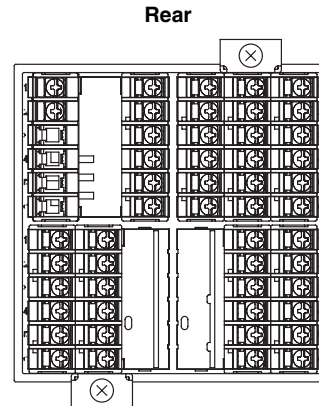
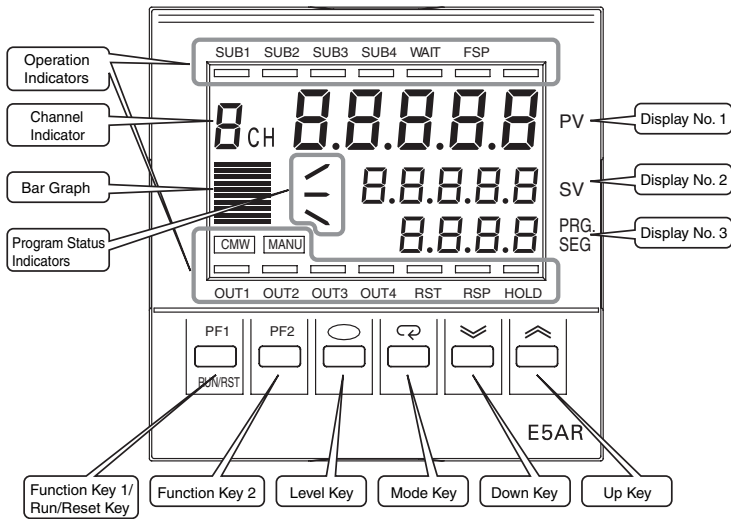

Dimensions

Note: All units are in millimeters unless otherwise indicated.

E5AR-T

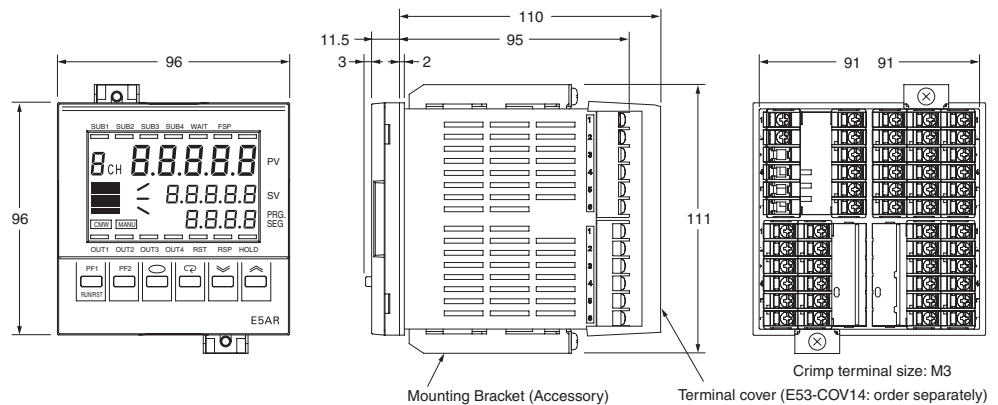
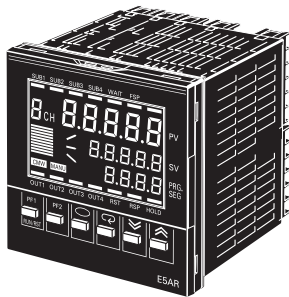

Panel Cutouts

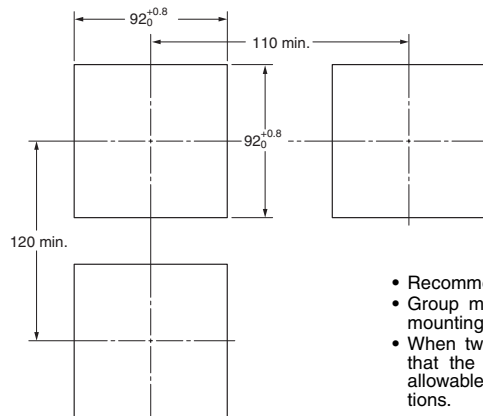

- Recommended panel thickness is 1 to 8 mm.
- Group mounting is not possible. (Maintain the specified mounting space between Controllers.)
- When two or more Controllers are mounted, make sure that the surrounding temperature does not exceed the allowable operating temperature specified in the specifications.

■ Accessories (Order Separately)

Terminal Cover

E53-COV14 (for E5AR)

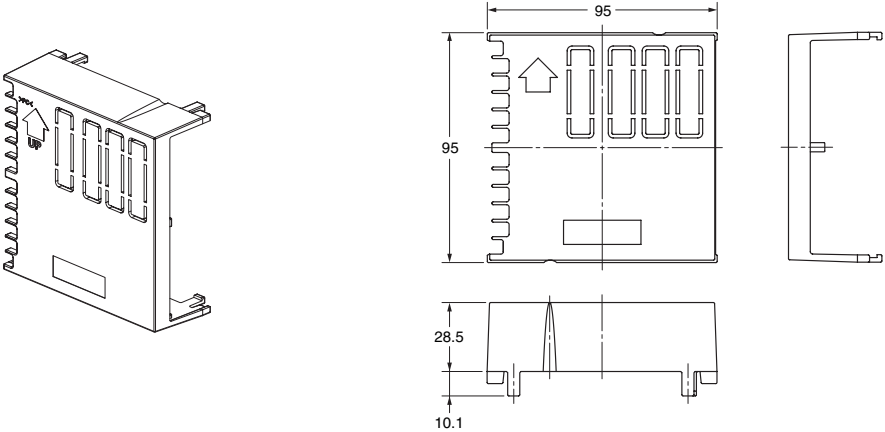

Unit Label Sheet

Y92S-L1

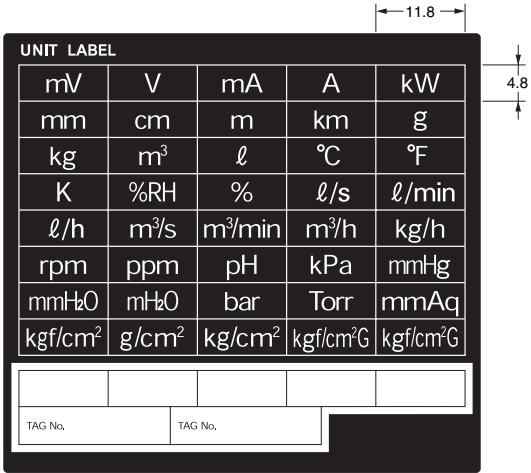

Rubber Packing

Y92S-P4 (for DIN96 × 96)

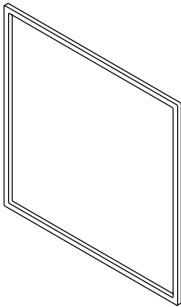

Order the Rubber Packing separately if it becomes lost or damaged. (Refer to page 2.)
 The Rubber Packing can be used to achieve an IP66 degree of protection.
 (Deterioration, shrinking, or hardening of the rubber packing may occur depending on the operating environment. Therefore, periodic replacement is recommended to ensure the level of waterproofing specified in NEMA4. The time for periodic replacement depends on the operating environment. Be sure to confirm this point at your site. Consider one year a rough standard. OMRON shall not be liable for the level of water resistance if the customer does not perform periodic replacement.)
 The Rubber Packing does not need to be attached if a waterproof structure is not required.

ALL DIMENSIONS SHOWN ARE IN MILLIMETERS.
 To convert millimeters into inches, multiply by 0.03937. To convert grams into ounces, multiply by 0.03527.

In the interest of product improvement, specifications are subject to change without notice.

Read and Understand This Catalog

Please read and understand this catalog before purchasing the products. Please consult your OMRON representative if you have any questions or comments.

Warranty and Limitations of Liability

WARRANTY

OMRON's exclusive warranty is that the products are free from defects in materials and workmanship for a period of one year (or other period if specified) from date of sale by OMRON.

OMRON MAKES NO WARRANTY OR REPRESENTATION, EXPRESS OR IMPLIED, REGARDING NON-INFRINGEMENT, MERCHANTABILITY, OR FITNESS FOR PARTICULAR PURPOSE OF THE PRODUCTS. ANY BUYER OR USER ACKNOWLEDGES THAT THE BUYER OR USER ALONE HAS DETERMINED THAT THE PRODUCTS WILL SUITABLY MEET THE REQUIREMENTS OF THEIR INTENDED USE. OMRON DISCLAIMS ALL OTHER WARRANTIES, EXPRESS OR IMPLIED.

LIMITATIONS OF LIABILITY

OMRON SHALL NOT BE RESPONSIBLE FOR SPECIAL, INDIRECT, OR CONSEQUENTIAL DAMAGES, LOSS OF PROFITS OR COMMERCIAL LOSS IN ANY WAY CONNECTED WITH THE PRODUCTS, WHETHER SUCH CLAIM IS BASED ON CONTRACT, WARRANTY, NEGLIGENCE, OR STRICT LIABILITY.

In no event shall the responsibility of OMRON for any act exceed the individual price of the product on which liability is asserted.

IN NO EVENT SHALL OMRON BE RESPONSIBLE FOR WARRANTY, REPAIR, OR OTHER CLAIMS REGARDING THE PRODUCTS UNLESS OMRON'S ANALYSIS CONFIRMS THAT THE PRODUCTS WERE PROPERLY HANDLED, STORED, INSTALLED, AND MAINTAINED AND NOT SUBJECT TO CONTAMINATION, ABUSE, MISUSE, OR INAPPROPRIATE MODIFICATION OR REPAIR.

Application Considerations

SUITABILITY FOR USE

OMRON shall not be responsible for conformity with any standards, codes, or regulations that apply to the combination of products in the customer's application or use of the products.

At the customer's request, OMRON will provide applicable third party certification documents identifying ratings and limitations of use that apply to the products. This information by itself is not sufficient for a complete determination of the suitability of the products in combination with the end product, machine, system, or other application or use.

The following are some examples of applications for which particular attention must be given. This is not intended to be an exhaustive list of all possible uses of the products, nor is it intended to imply that the uses listed may be suitable for the products:

- Outdoor use, uses involving potential chemical contamination or electrical interference, or conditions or uses not described in this catalog.
- Nuclear energy control systems, combustion systems, railroad systems, aviation systems, medical equipment, amusement machines, vehicles, safety equipment, and installations subject to separate industry or government regulations.
- Systems, machines, and equipment that could present a risk to life or property.

Please know and observe all prohibitions of use applicable to the products.

NEVER USE THE PRODUCTS FOR AN APPLICATION INVOLVING SERIOUS RISK TO LIFE OR PROPERTY WITHOUT ENSURING THAT THE SYSTEM AS A WHOLE HAS BEEN DESIGNED TO ADDRESS THE RISKS, AND THAT THE OMRON PRODUCTS ARE PROPERLY RATED AND INSTALLED FOR THE INTENDED USE WITHIN THE OVERALL EQUIPMENT OR SYSTEM.

PROGRAMMABLE PRODUCTS

OMRON shall not be responsible for the user's programming of a programmable product, or any consequence thereof.

Disclaimers

CHANGE IN SPECIFICATIONS

Product specifications and accessories may be changed at any time based on improvements and other reasons.

It is our practice to change model numbers when published ratings or features are changed, or when significant construction changes are made. However, some specifications of the products may be changed without any notice. When in doubt, special model numbers may be assigned to fix or establish key specifications for your application on your request. Please consult with your OMRON representative at any time to confirm actual specifications of purchased products.

DIMENSIONS AND WEIGHTS

Dimensions and weights are nominal and are not to be used for manufacturing purposes, even when tolerances are shown.

PERFORMANCE DATA

Performance data given in this catalog is provided as a guide for the user in determining suitability and does not constitute a warranty. It may represent the result of OMRON's test conditions, and the users must correlate it to actual application requirements. Actual performance is subject to the OMRON Warranty and Limitations of Liability.

ERRORS AND OMISSIONS

The information in this document has been carefully checked and is believed to be accurate; however, no responsibility is assumed for clerical, typographical, or proofreading errors, or omissions.

2012.8

In the interest of product improvement, specifications are subject to change without notice.

OMRON Corporation
Industrial Automation Company

<http://www.ia.omron.com/>

(c)Copyright OMRON Corporation 2012 All Right Reserved.