

D4SL-mounting Slide Key

D4SL-SK10-LK/-LKH**D4SL Door-mounting Accessory with Lockout Key to Prevent Workers from Becoming Trapped inside Hazardous Area**

- The vertical D4SL Guard Lock Safety-door Switch can be easily mounted on 40 × 40 mm aluminum frames.
- The plastic material makes the Slide Key suitable for lightweight doors.

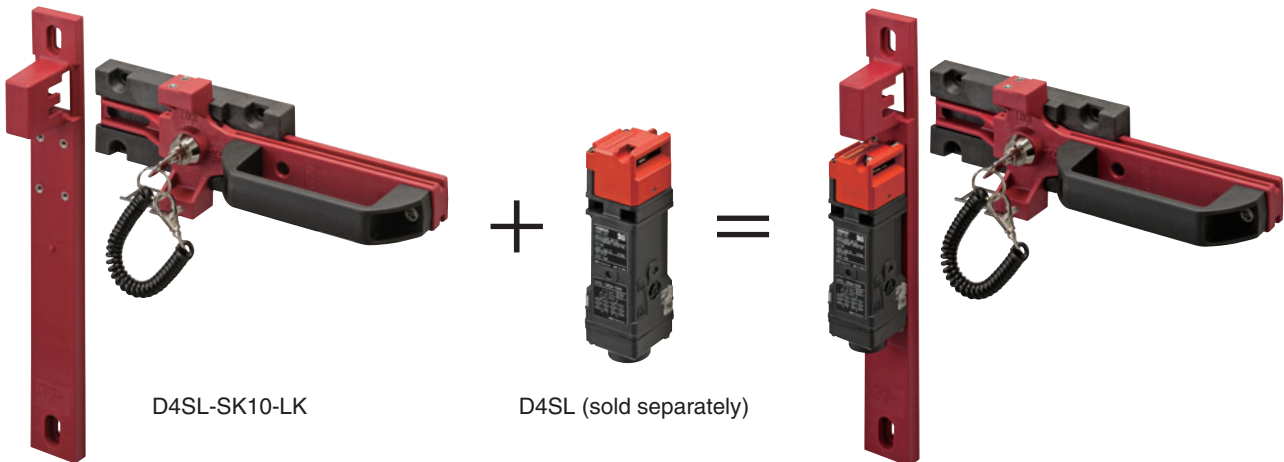
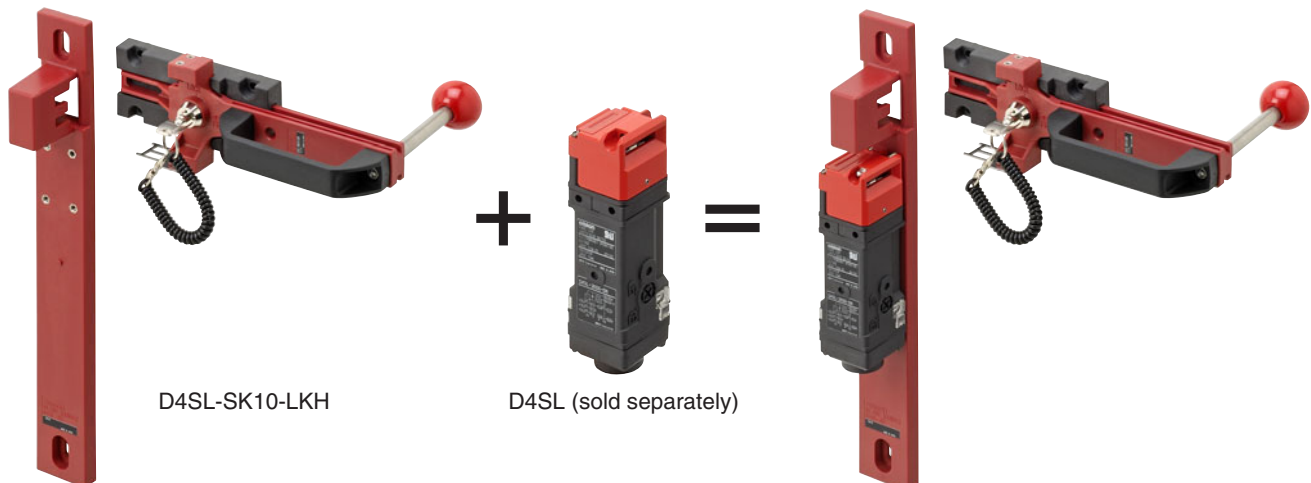

Be sure to read the "Safety Precautions" on page 6.

Configuration**D4SL-SK10-LK****D4SL-SK10-LKH**

Features

●The lockout key prevents workers from becoming trapped without using a padlock.

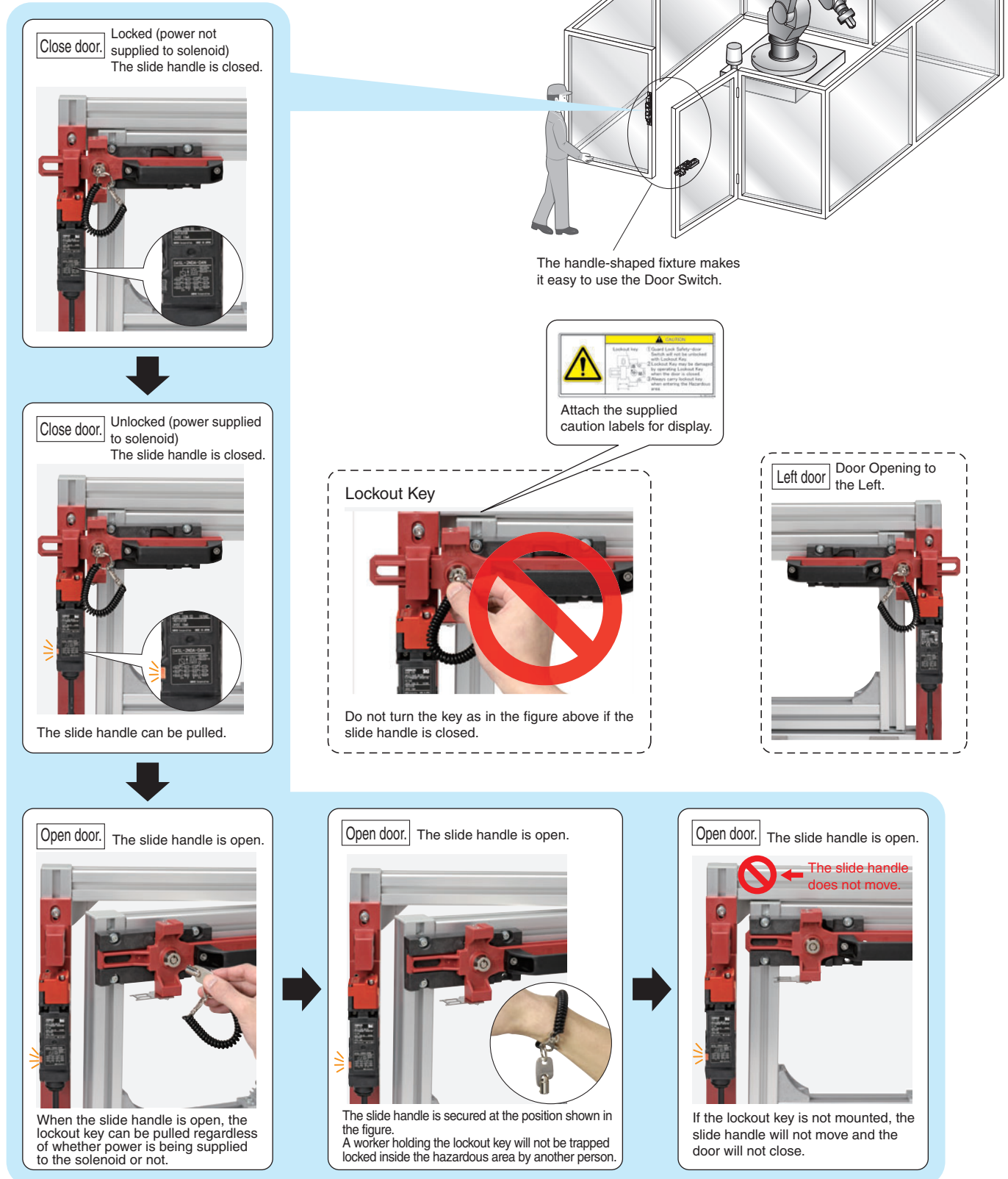

Note: Using LEDs enables confirming whether the door is locked or unlocked.

Example: D4SL-4NDA-D4N with mechanical lock and solenoid release



D4SL-SK10-LK/-LKH

Ordering Information

Type	Specifications	Contents	Model	Applicable Door Switch
	Weight: Approx. 0.6 kg Mechanical durability: 20,000 operations min.	Slide Key: 1 (not yet mounted) D4SL mounting plate: 1 Door Switch special mounting screws: 3 D4SL-K1S (operation key): 1 D4SL-K1S special mounting screws: 2 Lockout keys: 2 Lockout key strap: 1 Caution labels (stickers): 2 sheets (English and Japanese)	D4SL-SK10-LK	D4SL
	Weight: Approx. 0.7 kg Mechanical durability: 20,000 operations min.	Slide Key: 1 (not yet mounted) D4SL mounting plate: 1 Door Switch special mounting screws: 4 D4SL-K1S (operation key): 1 D4SL-K1S special mounting screws: 2 Lockout keys: 2 Lockout key strap: 1 Caution labels (stickers): 2 sheets (English and Japanese)	D4SL-SK10-LKH	D4SL
	Weight: Approx. 0.1 kg	Inner Lever:1	D4SL-SK10H *	—

Note: 1. The Door Switch is not included. Select the Door Switch depending on the necessary number of contacts and the conduit size. The contents are provided as a total set, individual contents cannot be ordered separately.

2. Perform risk assessment for the equipment in question, configure relay units and other safety circuits, and use properly.

*The inner lever for D4GL-SK10/D4SL-SK10 that can not be used for other products and applications.

Applicable Door Switches

Guard Lock Safety-door Switch D4SL



World Smallest Class 6-contact Guard Lock Safety-door Switch

- Two types are available: a connector type that reduces wiring time and a detachable terminal block type.
- Robust and durable metal head
- Key holding force of 1,300 N.
- The wider key slot is less susceptible to movement from doors, and can handle doors with a small radius.
- By rotating the mounting part, it is possible, both to change the key insertion point and to enable mounting on various devices.
- Easy view LED indicators
- By utilizing the 6-contact type, both the door open/closed status and the solenoid ON/OFF status can be monitored independently.
- A cost-effective 5-contact model is also available.

Model Number Legend

Switch

D4SL-□□□□-□□□□
1 2 3 4 5 6 7

1. Conduit Size

- 2 : G1/2 (1 conduit)
- 3 : 1/2-14NPT (1 conduit) *1
- 4 : M20 (1 conduit)

2. Built-in Switch *2

5-contact Model

- J : 1NC/1NO + 2NC/1NO
- K : 1NC/1NO + 3NC
- L : 2NC + 2NC/1NO
- M : 2NC + 3NC

6-contact Model

- N : 2NC/1NO + 2NC/1NO
- P : 2NC/1NO + 3NC
- Q : 3NC + 2NC/1NO
- R : 3NC + 3NC

3. Head Material

- D : Metal

Switch

D4SL-□□□□-□□□□-**SJ**
1 2 3 4 5 6 7

1. Conduit Size

- 2 : G1/2 (1 conduit)
- 4 : M20 (1 conduit)

2. Built-in Switch *2

6-contact Model

- N : 2NC/1NO + 2NC/1NO
- P : 2NC/1NO + 3NC
- Q : 3NC + 2NC/1NO
- R : 3NC + 3NC

3. Head Material

- D : Metal

4. Door Lock and Release

- A : Mechanical lock/24 VDC solenoid release
- G : 24 VDC solenoid lock/mechanical release

5. Indicator

- D : 24 VDC (orange LED indicator)

6. Release Key Type

- Blank : Standard release key

- 4 : Special release key

(Note: Release keys are provided.)

7. Connection Method

- Blank : Terminal block

- N : Connector *3

4. Door Lock and Release

- A : Mechanical lock/24 VDC solenoid release
- G : 24 VDC solenoid lock/mechanical release

5. Indicator

- D : 24 VDC (orange LED indicator)

6. Release Key Type

- Blank : Standard release key

7. Connection Method

- Blank : Terminal block

- N : Connector *3

*1. M20, includes M20-to-1/2-14NPT conversion adapter.

*2. For the solenoid lock model with built-in switch N, P, Q, and R, the door will not be locked when the solenoid is turned ON before the door is closed.
Be sure to close the door before turning ON the solenoid.

*3. Connector cables are not included with the connector type and are to be purchased separately.

D4SL-SK10-LK/LKH

Dimensions

(Unit: mm)

D4SL-SK10-LK

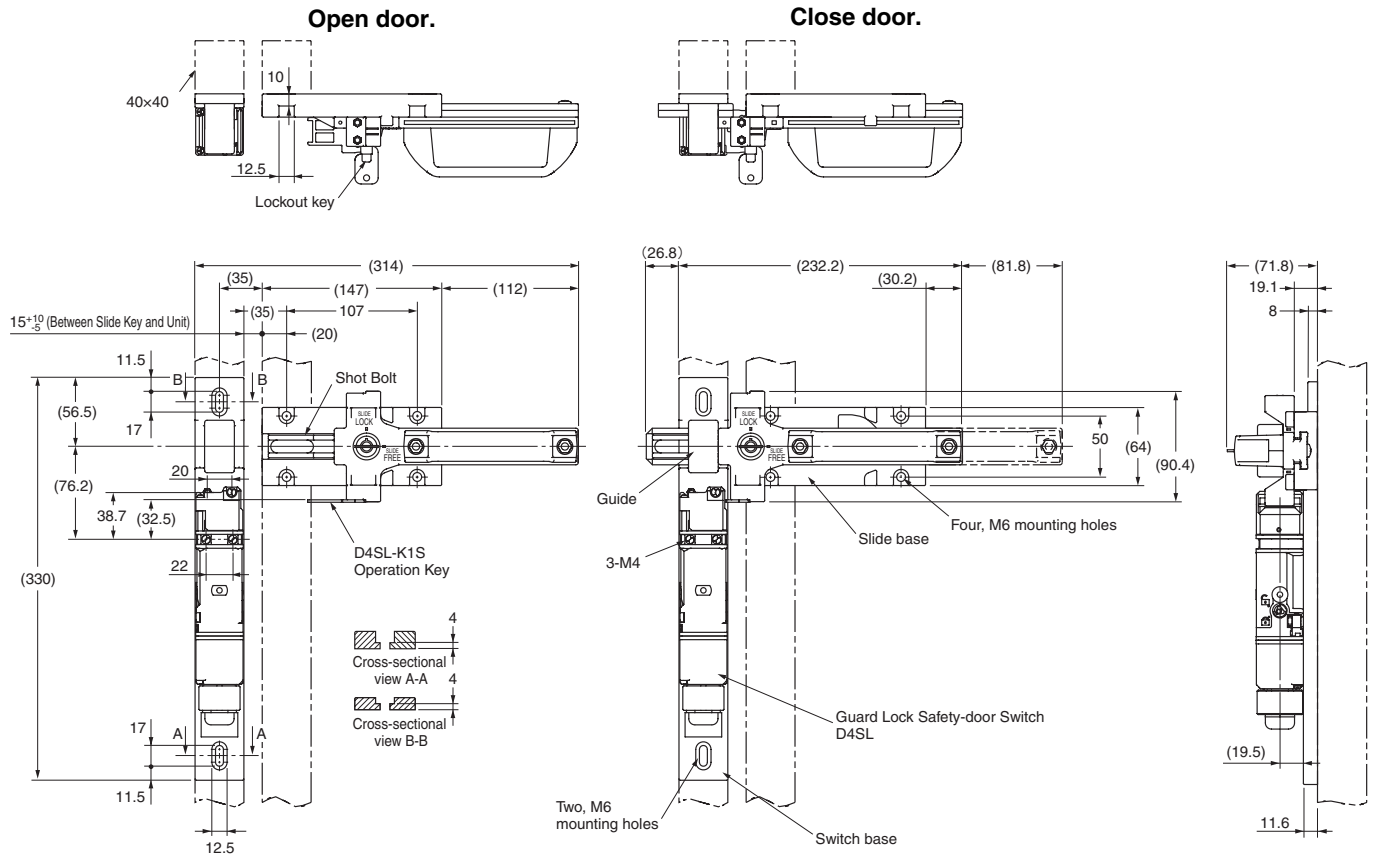

D4SL-SK10-LKH

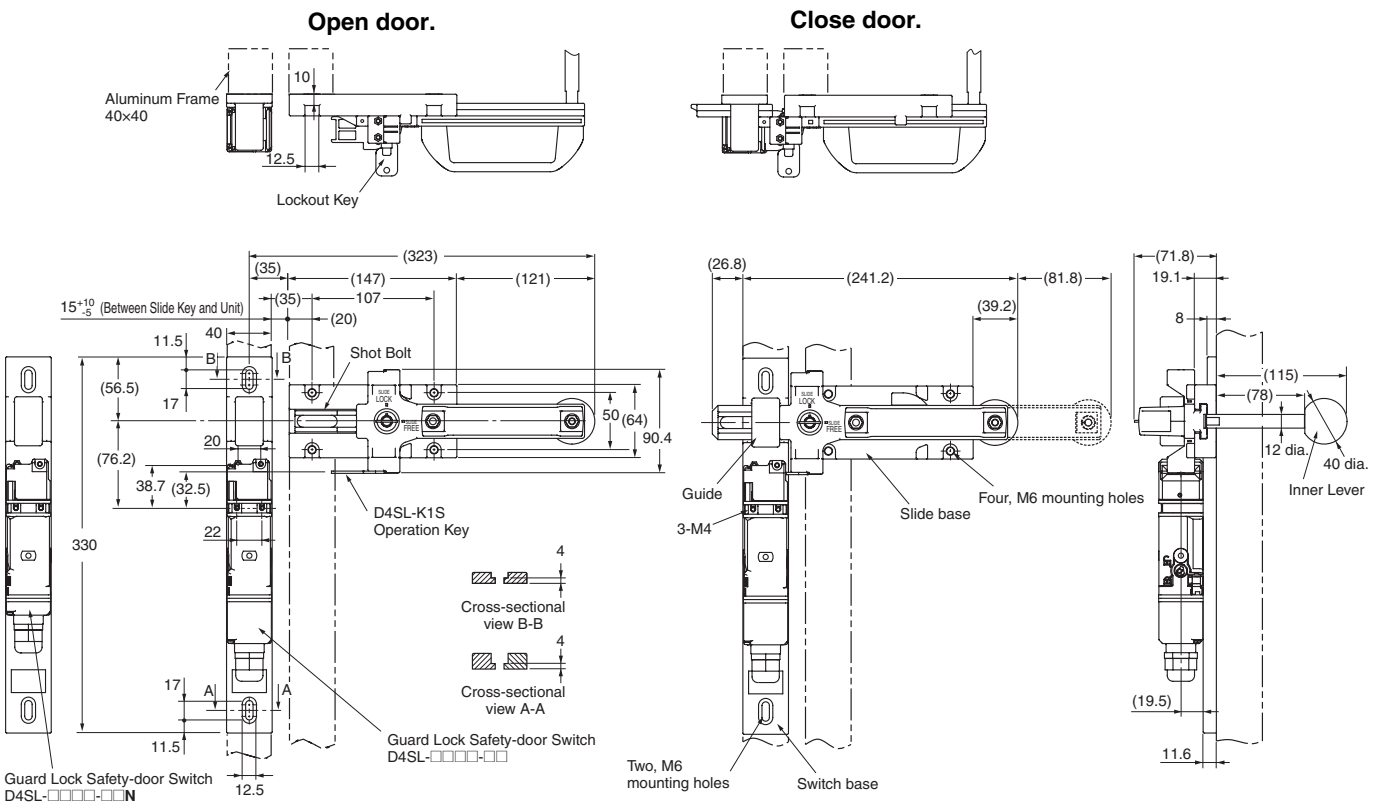

Safety Precautions

CAUTION

Do not use this product mounted so that it slides vertically. This may cause malfunction, resulting in personal injury.



Do not insert the operation key with the door open. Devices may start to operate, resulting in injury.



Precautions for Safe Use

- Do not drop the Product. Doing so may prevent the Product from functioning to full capacity.
- Mount the Product securely to prevent it from falling. Otherwise, injury may occur.
- Do not attempt to disassemble or modify the Switch. Doing so may cause the Switch to malfunction.
- Make sure that the gap between the shot bolt and the guide is ± 0.5 mm. Otherwise, excessive wear or damage may cause malfunction.
- To ensure safety, do not operate the Switch with anything other than the Slide Key Unit.
- Your hand may be injured by being pinched between the Operation Key and Switch when closing the door with your hand on the Product.
- Be careful to avoid pinching your hand when operating the Slide Handle.
- Do not impose a force of exceeding 1 N·m when operating the Lockout Key. Otherwise, the Product may be damaged and may not operate properly.
To prevent damage, attach the supplied labels for display near the Product.
- Do not force the slide handle to move when the lockout key is not inserted. Doing so may damage the product and make operation impossible.
- Do not force the slide handle to move when the door is locked. Doing so may damage the product and make operation impossible.
- Do not close the door with the shot bolt removed. Doing so may damage the product and make operation impossible.
- Turn the Lockout Key to the "SLIDE LOCK" position and remove it when opening the door to prevent a third party from operating the Slide Handle.
- The durability of the Switch varies considerably depending on the switching conditions. Always confirm the usage conditions by using the Switch in an actual application, and use the Switch only for the number of switching operations given in the performance specifications.
- The user must not maintain or repair equipment incorporating the Switch. Contact the manufacturer of the equipment for any maintenance or repairs required.
- Refer to the *D4SL Guard Lock Safety-door Switch Datasheet and Instruction Sheet* about storage conditions, ambient conditions, Switch details, and handling methods.
- Do not apply excessive force in the direction of the slide. This may damage the product and cause it to malfunction.
- Do not force the switch or cable. This may damage the product. The cable should be fixed at a point separate from the switch.

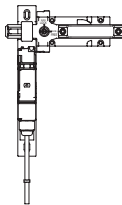

Precautions for Correct Use

- Use this product for a lightweight door (20 kg max). Otherwise the product may be damaged.
- This product is for D4SL Guard Lock Safety-door Switch only. This product cannot be used with any other manufacturer's door switches.
- Use the Slide Handle in the direction A or B in the following figure.

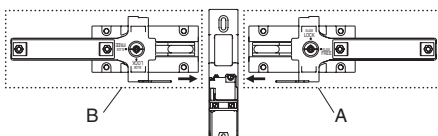

- Loose screws may result in malfunction. Use washers and tighten the screws to the specified torques. Mount the Slide Base at four points with screws. Adding adhesive is recommended for preventing the screws from loosening. Also, when mounting the Product to a door for disable-prevention purposes, purchase and use tamper-resistant screws.

Appropriate Tightening Torque

Slide Key mounting screw (M6)	6.0 to 7.0 N·m
Operation key special mounting screw (screws supplied)	2.4 to 2.8 N·m
Switch special mounting screw (screws supplied)	0.75 to 1.15 N·m
Inner Lever	9 to 10 N·m

Technical Specifications

Ambient operating temperature	-10 to 55°C (with no icing)
Ambient operating humidity	95% max.
Mechanical durability	20,000 operations min.

- Do not store the Switch where corrosive gases (e.g., H₂S, SO₂, NH₃, HNO₃ or Cl₂) or dust is present, or in locations subject to high temperature or humidity.
- Perform maintenance inspections periodically.
- When the lockout key is attached to your wrist, be careful that the strap does not get stuck in equipment.

Nomenclature

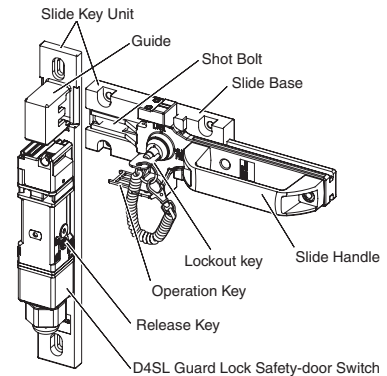

Differences between Lockout Key and Trapped Key (Reference)

	Lockout key	Trapped key (Refer to information on the D4JL-□□□A-□7-□□)
Closing the door	The door cannot be closed unless the lockout key is inserted in the slide and turned.	The door cannot be closed unless the trapped key is inserted in the Switch and turned.
Opening the door	The door can be opened by supplying power to the Switch solenoid without operating the lockout switch.	The door can never be opened without both supplying power to the Switch solenoid and operating the trapped key.

- When mounting the operation key, line up the inside edges of the long operation key holes with the outer edges of the slide handle as in the following figure to ensure easy position adjustment.
- Use the supplied special screws to mount the operation key and D4SL Guard Lock Safety-door Switch.
- To tighten the screws, use the tip of a flat-head screwdriver on the screw heads as shown in the following figure.
- The special screws cannot be removed once they are tightened.

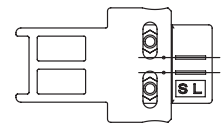

Note: The special screws are designed so that they cannot be turned counter-clockwise using a flat-head screwdriver.

D4SL-SK10-LK/-LKH

Mounting of inner lever

Mounting method

1) Detaching of mounting screw

Remove the handle mounting screw with TORX screwdriver (T30).

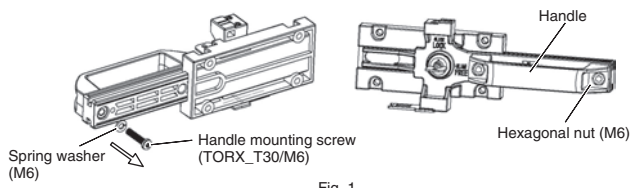

2) Mounting of inner lever

Tighten A portion of the inner lever to a suitable torque with wrench (width across flat: 10mm).

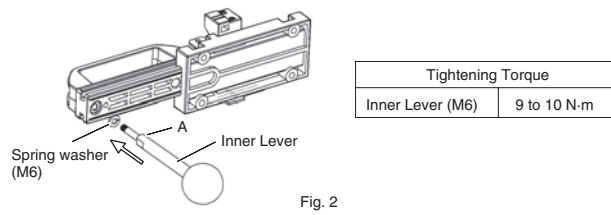

- This product is for Omron, the D4SL-SK10 and the D4GL-SK10 only. This product cannot be used with any other products.
- Do not operate the handle with the handle mounting screw removed. Doing so may result in malfunction.
- Be careful not to lose the spring washer and hexagonal nut when remove the handle mounting screw. (Fig.1)
- Loose inner lever may result in malfunction. Use washers and tighten the inner lever to the specified torque. (Fig.2)

READ AND UNDERSTAND THIS CATALOG

Please read and understand this catalog before purchasing the products. Please consult your OMRON representative if you have any questions or comments.

Warranty and Limitations of Liability

WARRANTY

OMRON's exclusive warranty is that the products are free from defects in materials and workmanship for a period of one year (or other period if specified) from date of sale by OMRON.

OMRON MAKES NO WARRANTY OR REPRESENTATION, EXPRESS OR IMPLIED, REGARDING NON-INFRINGEMENT, MERCHANTABILITY, OR FITNESS FOR PARTICULAR PURPOSE OF THE PRODUCTS. ANY BUYER OR USER ACKNOWLEDGES THAT THE BUYER OR USER ALONE HAS DETERMINED THAT THE PRODUCTS WILL SUITABLY MEET THE REQUIREMENTS OF THEIR INTENDED USE. OMRON DISCLAIMS ALL OTHER WARRANTIES, EXPRESS OR IMPLIED.

LIMITATIONS OF LIABILITY

OMRON SHALL NOT BE RESPONSIBLE FOR SPECIAL, INDIRECT, OR CONSEQUENTIAL DAMAGES, LOSS OF PROFITS OR COMMERCIAL LOSS IN ANY WAY CONNECTED WITH THE PRODUCTS, WHETHER SUCH CLAIM IS BASED ON CONTRACT, WARRANTY, NEGLIGENCE, OR STRICT LIABILITY.

In no event shall responsibility of OMRON for any act exceed the individual price of the product on which liability is asserted.

IN NO EVENT SHALL OMRON BE RESPONSIBLE FOR WARRANTY, REPAIR, OR OTHER CLAIMS REGARDING THE PRODUCTS UNLESS OMRON'S ANALYSIS CONFIRMS THAT THE PRODUCTS WERE PROPERLY HANDLED, STORED, INSTALLED, AND MAINTAINED AND NOT SUBJECT TO CONTAMINATION, ABUSE, MISUSE, OR INAPPROPRIATE MODIFICATION OR REPAIR.

Application Considerations

SUITABILITY FOR USE

OMRON shall not be responsible for conformity with any standards, codes, or regulations that apply to the combination of products in the customer's application or use of the product.

At the customer's request, OMRON will provide applicable third party certification documents identifying ratings and limitations of use that apply to the products. This information by itself is not sufficient for a complete determination of the suitability of the products in combination with the end product, machine, system, or other application or use.

The following are some examples of applications for which particular attention must be given. This is not intended to be an exhaustive list of all possible uses of the products, nor is it intended to imply that the uses listed may be suitable for the products:

- Outdoor use, uses involving potential chemical contamination or electrical interference, or conditions or uses not described in this document.
- Nuclear energy control systems, combustion systems, railroad systems, aviation systems, medical equipment, amusement machines, vehicles, safety equipment, and installations subject to separate industry or government regulations.
- Systems, machines, and equipment that could present a risk to life or property.

Please know and observe all prohibitions of use applicable to the products.

NEVER USE THE PRODUCTS FOR AN APPLICATION INVOLVING SERIOUS RISK TO LIFE OR PROPERTY WITHOUT ENSURING THAT THE SYSTEM AS A WHOLE HAS BEEN DESIGNED TO ADDRESS THE RISKS, AND THAT THE OMRON PRODUCT IS PROPERLY RATED AND INSTALLED FOR THE INTENDED USE WITHIN THE OVERALL EQUIPMENT OR SYSTEM.

Disclaimers

CHANGE IN SPECIFICATIONS

Product specifications and accessories may be changed at any time based on improvements and other reasons.

It is our practice to change model numbers when published ratings or features are changed, or when significant construction changes are made. However, some specifications of the product may be changed without any notice. When in doubt, special model numbers may be assigned to fix or establish key specifications for your application on your request. Please consult with your OMRON representative at any time to confirm actual specifications of purchased products.

DIMENSIONS AND WEIGHTS

Dimensions and weights are nominal and are not to be used for manufacturing purposes, even when tolerances are shown.

ERRORS AND OMISSIONS

The information in this document has been carefully checked and is believed to be accurate; however, no responsibility is assumed for clerical, typographical, or proofreading errors, or omissions.

PERFORMANCE DATA

Performance data given in this catalog is provided as a guide for the user in determining suitability and does not constitute a warranty. It may represent the result of OMRON's test conditions, and the users must correlate it to actual application requirements. Actual performance is subject to the OMRON Warranty and Limitations of Liability.

PROGRAMMABLE PRODUCTS

OMRON shall not be responsible for the user's programming of a programmable product, or any consequence thereof.

Copyright and Copy Permission

COPYRIGHT AND COPY PERMISSION

This document shall not be copied for sales or promotions without permission.

This document is protected by copyright and is intended solely for use in conjunction with the product. Please notify us before copying or reproducing this document in any manner, for any other purpose. If copying or transmitting this document to another, please copy or transmit it in its entirety.

OMRON Corporation Industrial Automation Company

Tokyo, JAPAN

Contact: www.ia.omron.com

Regional Headquarters

OMRON EUROPE B.V.

Wegalaan 67-69-2132 JD Hoofddorp
The Netherlands
Tel: (31)2356-81-300/Fax: (31)2356-81-388

OMRON SCIENTIFIC TECHNOLOGIES INC.

6550 Dumbarton Circle, Fremont
CA 94555-3605 U.S.A.
Tel: (1) 510-608-3400/Fax: (1) 510-744-1442

OMRON ASIA PACIFIC PTE. LTD.

No. 438A Alexandra Road # 05-05/08 (Lobby 2),
Alexandra Technopark,
Singapore 119967
Tel: (65) 6835-3011/Fax: (65) 6835-2711

OMRON (CHINA) CO., LTD.

Room 2211, Bank of China Tower,
200 Yin Cheng Zhong Road,
PuDong New Area, Shanghai, 200120, China
Tel: (86) 21-5037-2222/Fax: (86) 21-5037-2200

Authorized Distributor:

© OMRON Corporation 2009 All Rights Reserved.
In the interest of product improvement,
specifications are subject to change without notice.

CSM_2_1_0712

Cat. No. C144-E1-01

Printed in Japan

0310