

Non-Ferrous Sensing Inductive Prox

E2EY

Sensor Detects Only
Non-Ferrous Metals

- Provides long sensing distances for non-ferrous metals
- Easy to see operation indicator
- Shielded for flush mounting in metal
- Prewired with 2 meters (6.56 ft) of cable



Ordering Information

■ SENSORS

Sensing head	Detecting distance	Output	Part number
M18	4 mm (0.16 in)	NPN-NO	E2EY-X4C1
M30	8 mm (0.31 in)		E2EY-X8C1

■ ACCESSORIES

Description		Part number
Mounting brackets	Fits M18 size sensors	Y92E-B18
	Fits M30 size sensors	Y92E-B30
Protective covers for shielded sensors	Fits M18 size sensors	Y92E-E18-2
	Fits M30 size sensors	Y92E-E30-2

■ REPLACEMENT PARTS

Description		Part number
Mounting hardware including one pair of metal nuts and washers	M18 size sensors (supplied with each sensor)	M18-MHWS
	Fits M30 size sensors (supplied with each sensor)	M30-MHWS

Specifications

Part number		E2EY-X4C1	E2EY-X8C1
Sensor type		Inductive proximity sensor	
Body	Size	M18	M30
	Type	Shielded	
Supply voltage		10 to 30 VDC, max. ripple 10% peak-to-peak	
Current consumption		20 mA max.	
Detectable object type		Non-ferrous metals	
Effective detecting distance (with standard target)		4 mm (0.16 in)	8 mm (0.31 in)
Usable detecting range (with standard target)		0 to 2.8 mm (0 to 0.11 in)	0 to 5.6 mm (0 to 0.22 in)
Standard target size aluminum, L x W x H)		18 x 18 x 1 mm (0.71 x 0.71 x 0.04 in)	30 x 30 x 1 mm (1.18 x 1.18 x 0.04 in)
Differential travel		20% max. of effective detecting distance	
Control output	DC solid-state	Type	NPN-NO open collector
		Max. load	100 mA max.
		Max. on-state voltage drop	2 VDC (See graph in Engineering Data section)
Response frequency		70 Hz	
Circuit protection		Output short circuit, surge voltage, reverse polarity	
Indicators		Target present (red LED)	
Materials	Housing	Nickel-plated brass	
	Sensing face	ABS	
Mounting		Two M18 nuts included. Bracket Y92E-B18 optional.	Two M30 nuts included. Bracket Y92E-B30 optional.
Connections	Prewired	3-conductor cable, 2 m (6.56 ft) length	
Weight		140 g (5.5 oz.)	190 g (7.5 oz.)
Enclosure ratings	UL	—	
	NEMA	1, 3, 4, 6, 12, 13	
	IEC 144	IP67	
Approvals	UL	—	
	CSA	—	
Ambient operating temperature		-10° to 55°C (14° to 131°F)	
Vibration		10 to 55 Hz, 1.5 mm (0.06 in) double amplitude for 2 hours each in X, Y, and Z directions	

Operation

■ OUTPUT CIRCUIT DIAGRAMS AND CONNECTIONS

NPN Output Type

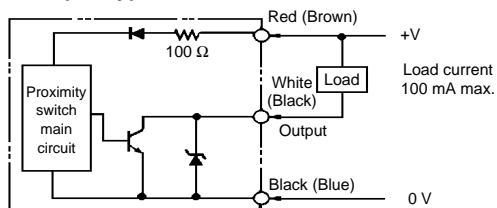

Note: IEC colors are shown in parentheses.

■ TIMING CHARTS

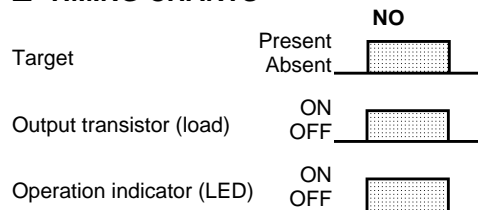

Engineering Data

OPERATING RANGE

E2EY-X4

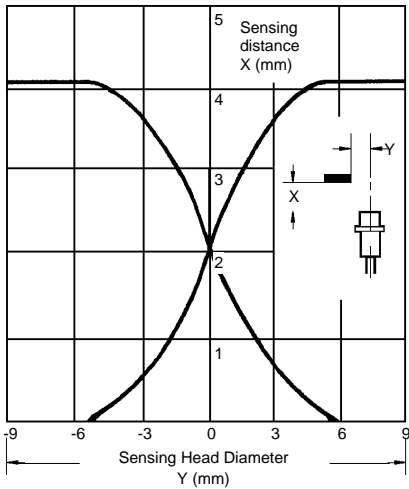

E2EY-X8

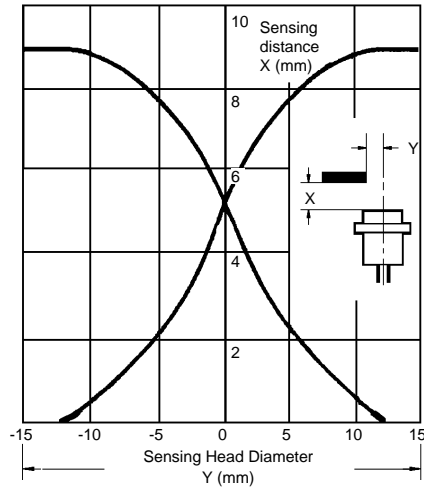

SENSING DISTANCE vs. SIZE AND MATERIAL OF TARGET

E2EY-X4

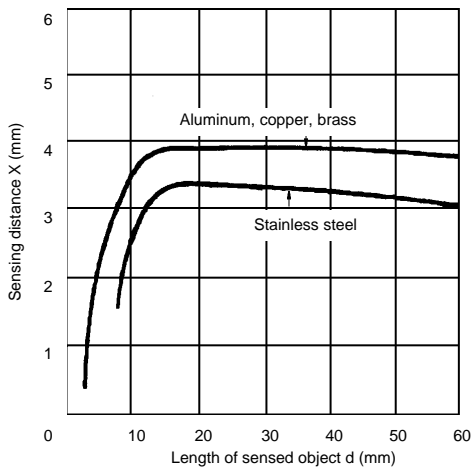

E2EY-X8

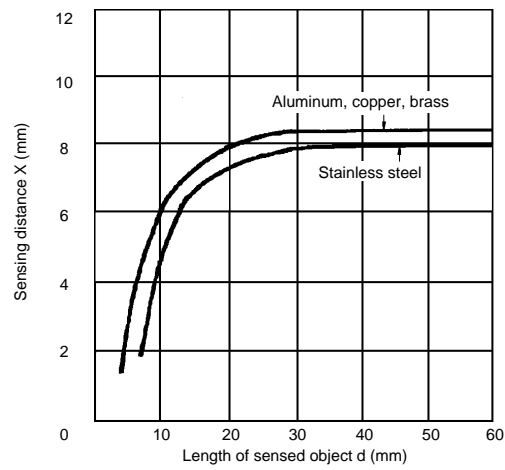

ON-STATE VOLTAGE DROP

E2EY

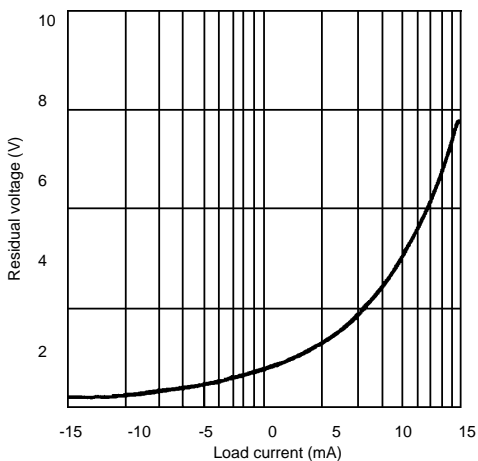

Dimensions

Unit: mm

E2EY-X4C1

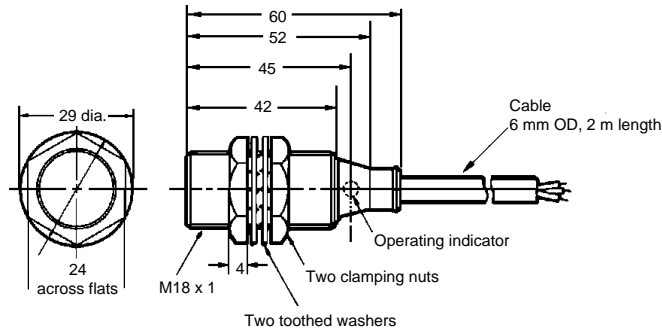
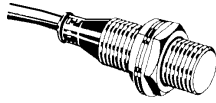

E2EY-X8C1

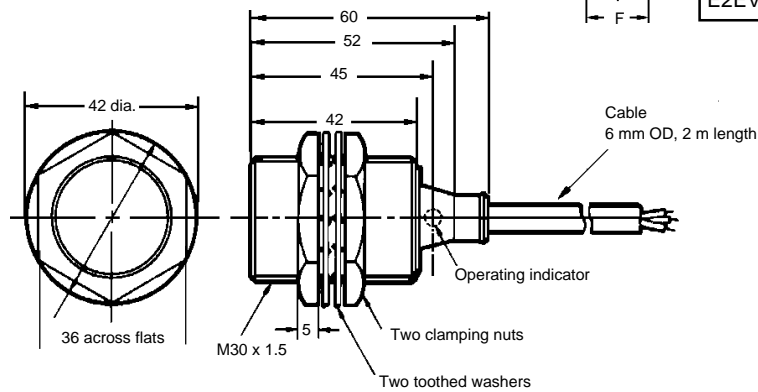
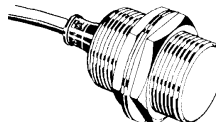

Mounting holes

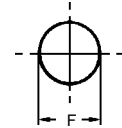

Model	Diameter
E2EV-X4C1	18.5 mm (0.73 in)
E2EV-X8C1	30.5 mm (1.20 in)

Precautions

■ EFFECTS OF SURROUNDING METAL

When mounting a proximity sensor flush with a metallic panel, provide the minimum distance shown. This prevents the sensor from being affected by metallic objects other than the target.

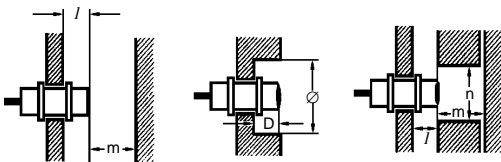

Model	E2EY-X4C1	E2EY-X8C1
<i>l</i>	0 mm	0 mm
<i>d</i>	18 mm (0.71 in)	30 mm (1.18 in)
<i>D</i>	0	0
<i>m</i>	20 mm (0.79 in)	40 mm (1.57 in)
<i>n</i>	27 mm (1.06 in)	45 mm (1.77 in)

■ MUTUAL INTERFERENCE

To prevent mutual interference between two sensors mounted opposite or parallel to each other, be sure to space the two sensors at a distance greater than that shown here.

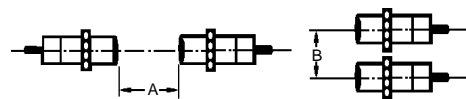

Model	A	B
E2EY-X4C1	50 mm (1.97 in)	35 mm (1.38 in)
E2EY-X8C1	100 mm (3.94 in)	70 mm (2.76 in)

OMRON

OMRON ELECTRONICS LLC

One East Commerce Drive
Schaumburg, IL 60173
1-800-55-OMRON

OMRON ON-LINE

Global - <http://www.omron.com>
USA - <http://www.omron.com/oei>
Canada - <http://www.omron.com/oci>

OMRON CANADA, INC.

885 Milner Avenue
Scarborough, Ontario M1B 5V8
416-286-6465