

## Digital Fiber Sensors

# E3X-DA-S

### An Extensive of Standard Functions to Support the World's Highest Level of Stable Detection.

- "GIGA RAY" Giga Power Lighting Element to create a wide variety of value.
- Power turning to easily set the optimum light level.
- Active Threshold Control (ATC) reduces incorrect operation due to dust, oil, or other influences.
- Automatic Power Control (APC) is always enabled to stabilize emitter power with high accuracy.



## Ordering Information



### Amplifier Units [\[Dimensions→page 23\]](#)

Type	Appearance	Connecting method	Model		Applicable wire-saving connector (sold separately)	
			NPN output	PNP output	Type	Model
Standard models		Pre-wired (2 m)	<b>E3X-DA21-S 2M</b>	<b>E3X-DA51-S 2M</b>	---	---
		Wire-saving connector*	<b>E3X-DA7-S</b>	<b>E3X-DA9-S</b>	Master connector	<b>E3X-CN21</b>
Ultra-long-term APC models		Pre-wired (2 m)	<b>E3X-DA21R-S 2M</b>	<b>E3X-DA51R-S 2M</b>	---	---
		Wire-saving connector*	<b>E3X-DA7R-S</b>	<b>E3X-DA9R-S</b>	Master connector	<b>E3X-CN21</b>
High-speed response models		Pre-wired (2 m)	<b>E3X-DA21F-S 2M</b>	<b>E3X-DA51F-S 2M</b>	---	---
		Wire-saving connector*	<b>E3X-DA7F-S</b>	<b>E3X-DA9F-S</b>	Master connector	<b>E3X-CN11</b>
					Slave connector	<b>E3X-CN12</b>

\* An Wire-saving connector sold separately is required.

# E3X-DA-S

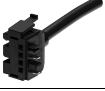
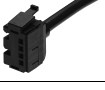
## Wire-saving connector (sold separately) Protection stickers attached [\[Dimensions→page 25\]](#)

Type	Appearance	Cable length	No. of conductors	Model
Master connector		2 m	4	E3X-CN21
Slave connector			2	E3X-CN22
Master connector			3	E3X-CN11
Slave connector			1	E3X-CN12

**Note:** The E3X-CN11/12 can also be used to connect to the E3X-DA□-S (□: 7/9) or the E3X-DA□R-S (□: 7/9), but the output lines will support only 1 channel. Output function for channel 2 or APC alarm output function will be disabled.

## Accessories (sold separately)

### Mounting Brackets [\[Dimensions→page 26\]](#)

Appearance	Model	Quantity
	E39-L143	1

### End Plate [\[Dimensions→page 26\]](#)

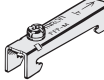
Appearance	Model	Quantity
	PFP-M	1

## Product Overview

●: Strong point of the model ○: Provided ---: Not provided

Item	Types Connecting method Models	Standard models		Ultra-long-term APC models		High-speed response models	
		Pre-wired	Wire-saving connector	Pre-wired	Wire-saving connector	Pre-wired	Wire-saving connector
		E3X-DA21-S E3X-DA51-S	E3X-DA7-S E3X-DA9-S	E3X-DA21R-S E3X-DA51R-S	E3X-DA7R-S E3X-DA9R-S	E3X-DA21F-S E3X-DA51F-S	E3X-DA7F-S E3X-DA9F-S
Input/output	External input	1 input	---	1 input	---	---	
	Output	2 outputs		1 output and 1 APC alarm output		1 output	
Performance	Sensing distance with E32-T11R	280 to 2,000 mm (Depends on response time)		140 to 1,000 mm (Depends on response time)		280 mm (Only Super-high-speed Mode)	
	Sensing distance with E32-D11R	100 to 840 mm (Depends on response time)		50 to 420 mm (Depends on response time)		100 mm (Only Super-high-speed Mode)	
	Giga Power (GIGA RAY)	● (Margin: × 160)		○		○	
	High-speed response	○ (80 μs)		○ (80 μs)		● (46 μs)	
Function	Power tuning	○		○		○	
	Automatic power control (APC)	○		● (Ultra-long-term APC)		○	
	Timer	○		○		○	
	ATC	○		○		○	
	Key lock	○		○		○	
	Easy key lock (switchable)	---		○		○	
	APC margin display	---		○		---	
	Slow-motion display	---		---		○	

## Ratings and Specifications

### Amplifier Units

Item	Type Model	Standard models	Ultra-long-term APC models	High-speed response models
		E3X-DA□-S (□: 21/51/7/9)	E3X-DA□R-S (□: 21/51/7/9)	E3X-DA□F-S (□: 21/51/7/9)
Light source (wavelength)		Red,4-element LED (625 nm)		
Power supply voltage		12 to 24 VDC ±10%, ripple (p-p) 10% max.		
Power consumption		Normal mode : 960 mW max. (Current consumption: 40 mA max. at 24 VDC, 80 mA max. at 12 VDC) Power saving ECO1: 720 mW max. (Current consumption: 30 mA max. at 24 VDC, 60 mA max. at 12 VDC) Power saving ECO2: 600 mW max. (Current consumption: 25 mA max. at 24 VDC, 50 mA max. at 12 VDC)		
Control output / APC alarm output		Load power supply voltage: 26.4 VDC max.; NPN/PNP open collector; load current: 50 mA max.; residual voltage: 2 V max.		
External input *1		No-voltage input (contact / transistor) *2		---
Protection circuits		Power supply reverse polarity protection, output short-circuit protection and output reverse polarity protection		
Re-sponse time	Super-high-speed Mode *3	Operate or reset: 80 μs		NPN output: Operate: 46 μs, Reset: 48 μs PNP output: Operate: 51 μs, Reset: 53 μs
	High-speed Mode	Operate or reset: 250 μs		---
	Standard Mode	Operate or reset: 1 ms		
	High-resolution Mode	Operate or reset: 4 ms		
	Tough Mode	Operate or reset: 16 ms		
Sensitivity setting		Teaching or manual method		
Func-tions	Power tuning	Light emission power and reception gain, digital control method		
	Differential detection	Switchable between Single-edge and Double-edge Detection Modes. Single edge: Set to 250 μs, 500 μs, 1 ms, 10 ms, or 100 ms. Double edge: Set to 500 μs, 1 ms, 2 ms, 20 ms, or 200 ms		---
	Automatic power control (APC)	Always enabled. High-speed control of emission current Wide-range APC for the E3X-DA□R-S		
	Timer	Select from timer disabled, OFF-delay, ON-delay, One-shot, or ON-delay + OFF-delay timer 1 ms to 5 s (1 to 20 ms set in 1-ms increments, 20 to 200 ms set in 10-ms increments, 200 ms to 1 s set in 100-ms increments, and 1 to 5 s set in 1-s increments)		
	ATC	Provided		
	APC margin display	---	Provided	---
	Slow-motion display	---		Provided
	Zero reset	Negative values can be displayed. (Threshold value is shifted.)		
	Resetting settings	Select from initial reset (factory defaults) or user reset (saved settings).		
	Mutual interference prevention	Possible for up to 10 units *4		---
	ECO Mode *5	Select from OFF (digital display lit), ECO1 (digital display dimmed), and ECO2 (digital display OFF).		
	External input setting *1	Select from teaching operations, power tuning, zero reset, emitter OFF, or ATC start.		---
Output setting	Select from output for each channel, area output, or self-diagnosis.	---		
Indicator	Operation indicator for channel 1(orange) Operation indicator for channel 2(orange)	Operation indicator for channel 1(orange) APC alarm output indicator (orange)	Operation indicator for channel 1(orange) Power tuning indicator (orange)	

\*1. Only for Pre-wired models.

\*2. The following details apply to inputs.

	Contact input (relay or switch)	Non-contact input (transistor)
NPN	ON: Shorted to 0 V (sourcing current: 1 mA max.). OFF: Open or shorted to Vcc.	ON: 1.5 V max. (sourcing current: 1 mA max.) OFF: Vcc - 1.5 V to Vcc (leakage current: 0.1 mA max.)
PNP	ON: Shorted to Vcc (sinking current: 3 mA max.). OFF: Open or shorted to 0 V.	ON: Vcc - 1.5 V to Vcc (sinking current: 3 mA max.) OFF: 1.5 V max. (leakage current: 0.1 mA max.)

\*3. The communications function and mutual interference prevention function are disabled if detection is set to Super-high-speed mode.

\*4. Mutual interference prevention is enabled if Amplifier Units are connected together. It is also enabled in the same way if E3X-DA-S-series Units and E3C-LDA-series Units are used together. If power tuning is enabled, mutual interference prevention can be used for up to six units.

\*5. For the E3X-DA□-S (□: 21/51/7/9), the rated sensing distance is approximately 1/2 and the incident level is approximately 1/3 of the normal levels when ECO mode is enabled.

# E3X-DA-S

Item	Model	E3X-DA□-S (□: 21/51/7/9)	E3X-DA□R-S (□: 21/51/7/9)	E3X-DA□F-S (□: 21/51/7/9)
Digital display		Select from incident level + threshold or other 6 patterns (Refer to 6. <i>Display switch</i> on page 17.)		
Display orientation		Switching between normal / reversed display is possible.		
Key lock		Key lock	Key lock / Easy key lock.	
Ambient illumination (Receiver side)		Incandescent lamp: 10,000 lux max. Sunlight: 20,000 lux max.		
Maximum connectable Units		16 (The ambient temperature specification depends on the number of connected units.)		
Ambient temperature range		Operating: Groups of 1 to 2 Amplifiers: -25 to 55°C Groups of 3 to 10 Amplifiers: -25 to 50°C Groups of 11 to 16 Amplifiers: -25 to 45°C		
		Storage: -30 to 70°C (with no icing or condensation)		
Ambient humidity range		Operating and storage: 35% to 85% (with no condensation)		
Insulation resistance		20 MΩ min. (at 500 VDC)		
Dielectric strength		1,000 VAC at 50/60 Hz for 1 minute		
Vibration resistance		Destruction: 10 to 55 Hz with a 1.5-mm double amplitude for 2 hours each in X, Y and Z directions		
Shock resistance		Destruction: 500 m/s <sup>2</sup> for 3 times each in X, Y and Z directions		
Degree of protection		IEC 60529 IP50 (with Protective Cover attached)		
Connection method		Pre-wired (standard length 2 m) or Wire-saving connector		
Weight (packed state)		Pre-wired models: Approx. 100 g, Wire-saving connector models: Approx. 55 g		
Materials	Case	Polybutylene terephthalate (PBT)		
	Cover	Polycarbonate (PC)		
Accessories		Instruction Manual		

## Wire-saving connectors

Item	Model	E3X-CN21/22/11	E3X-CN12
Rated current		2.5 A	
Rated voltage		50 V	
Contact resistance		20 mΩ max. (20 mVDC max., 100 mA max.) (The figure is for connection to the Amplifier Unit and the adjacent connector. It does not include the conductor resistance of the cable.)	
No. of insertions		Destruction: 50 times (The figure for the number of insertions is for connection to the Amplifier Unit and the adjacent connector.)	
Materials	Housing	Polybutylene terephthalate (PBT)	
	Contacts	Phosphor bronze / gold-plated nickel	
Weight (packed state)		Approx. 55 g	Approx. 25 g

## Sensing Distance

## E3X-DA□-S (□: 21/51/7/9) ■ E3X-DA□F-S (□: 21/51/7/9)

Note: The E3X-DA□F-S uses only Super-high-speed mode. The sensing distance is the same as for the Super-high-speed mode of the E3X-DA□-S.

Fiber Unit			Amplifier Unit	E3X-DA□-S (□: 21/51/7/9)				
Screw-shaped model				Sensing distance (unit: mm)				
Sensing method	Size	Sensing direction	Model	Tough mode	High-resolution mode	Standard mode	High-speed mode	Super-high-speed mode
Through-beam models	M3	Straight	E32-T21R 2M	450	300	250	150	60
		Right angle	E32-T11N 2M	2,000	1,400	1,000	700	280
	M4	Straight	E32-T11R 2M	2,000	1,400	1,000	700	280
			E32-TC200 2M	2,800	2,000	1,550	1,000	400
			E32-T11L 2M	4,000 *	3,400	2,700	1,740	700
Reflective models	M3	Right angle	E32-C31N 2M	110	80	50	46	14
			E32-D21R 2M	140	100	60	40	16
		Straight	E32-C31 2M	330	240	150	100	44
			E32-D211R 2M	140	100	60	40	16
	M4	Right angle	E32-D11N 2M	840	600	350	240	100
			E32-C11N 2M	780	560	350	320	100
	M6	Straight	E32-D11R 2M	840	600	350	240	100
			E32-DC200 2M	1,400	1,000	600	400	180
			E32-CC200 2M	1,400	1,000	600	400	180
			E32-D11L 2M	1,820	1,300	800	520	220

\* The fiber length is 2 m on each side, so the sensing distance is given as 4,000 mm.

Fiber Unit			Amplifier Unit	E3X-DA□-S (□: 21/51/7/9)				
Flat model				Sensing distance (unit: mm)				
Sensing method	Sensing direction	Size	Model	Tough mode	High-resolution mode	Standard mode	High-speed mode	Super-high-speed mode
Through-beam models	Top view	Standard	E32-T15XR 2M	2,000	1,400	1,000	700	280
		Small	E32-T25XR 2M	450	300	250	150	60
	Side view	Standard	E32-T15YR 2M	750	550	450	260	100
		Small	E32-T25YR 2M	170	120	100	50	20
	Flat view	Standard	E32-T15ZR 2M	750	550	450	260	100
		Small	E32-T25ZR 2M	170	120	100	50	20
Reflective models	Top view	Standard	E32-D15XR 2M	840	600	350	240	100
		Small	E32-D25XR 2M	140	100	60	40	16
	Side view	Standard	E32-D15YR 2M	200	140	100	52	24
		Small	E32-D25YR 2M	40	28	16	10	4
	Flat view	Standard	E32-D15ZR 2M	200	140	100	52	24
		Small	E32-D25ZR 2M	40	28	16	10	4

Fiber Unit			Amplifier Unit	E3X-DA□-S (□: 21/51/7/9)				
Cylindrical model				Sensing distance (unit: mm)				
Sensing method	Sensing direction	Size	Model	Tough mode	High-resolution mode	Standard mode	High-speed mode	Super-high-speed mode
Through-beam models	Top view	φ1	E32-T223R 2M	450	300	250	150	60
		φ3	E32-T12R 2M	2,000	1,400	1,000	700	280
	Side view	φ1	E32-T24R 2M	170	120	100	50	20
		φ3	E32-T14LR 2M	750	550	450	260	100
Reflective models	Top view	φ1.5	E32-D22B 2M	140	100	60	40	16
		φ2	E32-D32 2M	330	240	150	100	44
		φ3	E32-D22R 2M	140	100	60	40	16
			E32-D32L 2M	700	500	300	200	90
	Side view	φ2	E32-D24R 2M	70	52	30	20	8
		φ6	E32-D14LR 2M	220	160	100	60	28

Fiber Unit			Amplifier Unit	E3X-DA□-S (□: 21/51/7/9)				
Model equipped with sleeve				Sensing distance (unit: mm)				
Sensing method	Sleeve size	Mounting size	Model	Tough mode	High-resolution mode	Standard mode	High-speed mode	Super-high-speed mode
Through-beam models	φ0.25 × 5	φ3	E32-T333-S5 1M	35	25	20	12	8
	φ0.5 × 40		E32-T33 1M	150	110	90	50	20
	φ0.9 × 40	M3	E32-TC200F4R 2M	450	300	250	150	60
	φ1.2 × 90	M4	E32-TC200BR 2M	2,000	1,400	1,000	700	280
Reflective models	φ0.5 × 15	φ2	E32-D331 2M	14	10	6	4	2
	φ0.8 × 15	φ3	E32-D33 2M	70	50	30	20	8
	φ1.2 × 40	M3	E32-DC200F4R 2M	140	100	60	40	16
	φ2.5 × 90	M6	E32-DC200BR 2M	840	600	350	240	100

For information on Fiber Units, refer to the Fiber Sensors Best Selection Catalog (Cat. No. E353).

# E3X-DA-S

## E3X-DA□-S (□: 21/51/7/9) ■ E3X-DA□F-S(□: 21/51/7/9)

Note: The E3X-DA□F-S uses only Super-high-speed mode. The sensing distance is the same as for the Super-high-speed mode of the E3X-DA□-S.

Fiber Unit			Amplifier Unit	E3X-DA□-S (□: 21/51/7/9)				
Movable section (Flexibility)				Sensing distance (unit: mm)				
Sensing method	Type	Size	Model	Tough mode	High-resolution mode	Standard mode	High-speed mode	Super-high-speed mode
Through-beam models	Screw-shaped model	M3	E32-T21 2M	680	480	400	220	90
		M4	E32-T11 2M	2,500	1,800	1,350	900	360
	Cylindrical model	φ1.5	E32-T22B 2M	680	480	400	220	90
		φ3	E32-T12B 2M	2,500	1,800	1,350	900	360
	Flat model	Standard	E32-T15XB 2M	2,500	1,800	1,350	900	360
		Small	E32-T25XB 2M	500	360	300	170	70
Reflective models	Screw-shaped model	M3	E32-D21 2M	140	100	60	40	16
		M4	E32-D21B 2M	300	220	140	90	40
		M6	E32-D11 2M	840	600	350	240	100
	Cylindrical model	φ1.5	E32-D22B 2M	140	100	60	40	16
		φ3	E32-D221B 2M	300	220	140	90	40
	Flat model	Standard	E32-D15XB 2M	840	600	350	240	100
		Small	E32-D25XB 2M	240	170	100	60	30

Fiber Unit			Amplifier Unit	E3X-DA□-S (□: 21/51/7/9)				
Heat-resistance model				Sensing distance (unit: mm)				
Sensing method	Operating temperature	Lens	Model	Tough mode	High-resolution mode	Standard mode	High-speed mode	Super-high-speed mode
Through-beam models	100°C	---	E32-T51R 2M	1,600	1,100	800	560	225
		Lens	E32-T51R 2M + E39-F1	4,000 *	4,000 *	4,000 *	3,900	1,500
		High-power lens	E32-T51R 2M + E39-F16	4,000 *	4,000 *	4,000 *	4,000 *	4,000 *
	150°C	---	E32-T51 2M	2,800	2,000	1,500	1,000	400
		Lens	E32-T51 2M + E39-F1-33	4,000 *	4,000 *	4,000 *	2,300	1,400
		High-power lens	E32-T51 2M + E39-F16	4,000 *	4,000 *	4,000 *	4,000 *	4,000 *
	200°C	---	E32-T54 2M	840	600	450	300	120
			E32-T81R-S 2M	1,000	720	550	360	140
		Lens	E32-T61-S 2M	1,680	1,200	900	600	240
			E32-T61-S 2M + E39-F1	4,000 *	4,000 *	4,000 *	4,000 *	1,800
	350°C	---	E32-T61-S 2M	1,680	1,200	900	600	240
		High-power lens	E32-T61-S 2M + E39-F16	4,000 *	4,000 *	4,000 *	4,000 *	3,100
Reflective models	100°C	---	E32-D51R 2M	670	480	280	190	80
	150°C		E32-D51 2M	1,120	800	450	320	144
	200°C		E32-D81R 2M	420	300	180	120	54
	350°C		E32-D61 2M	420	300	180	120	54
	400°C		E32-D73 2M	280	200	120	80	36

\* The fiber length is 2 m on each side, so the sensing distance is given as 4,000 mm.

Fiber Unit			Amplifier Unit	E3X-DA□-S (□: 21/51/7/9)					
Chemical-resistance / Oil-resistance model				Sensing distance (unit: mm)					
Sensing method	Type	Model		Tough mode	High-resolution mode	Standard mode	High-speed mode	Super-high-speed mode	
Through-beam models	φ5	E32-T12F 2M		4,000 *1	4,000 *1	4,000 *1	4,000 *1	1,600	
	φ7.2	E32-T11F 2M		4,000 *1	4,000 *1	4,000 *1	2,600	1,000	
	φ5	Heat-resistance model	E32-T51F 2M	4,000 *1	3,600	2,800	1,800	700	
	φ5	Side view	E32-T14F 2M		1,400	1,000	800	500	200
	M4	Chemical-resistance cable	E32-T11U 2M		2,500	1,800	1,350	900	360
	M4	Right angle Chemical-resistance cable	E32-T11NU 2M		1,440	1,040	800	520	200
Reflective models	φ6	E32-D12F 2M		---	320	190	130	60	
	φ7	Side view	E32-D14F 2M		---	140	80	60	20
	M6	Chemical-resistance cable	E32-D11U 2M		840	600	350	240	100

\*1. The fiber length is 2 m on each side, so the sensing distance is given as 4,000 mm.

\*2. Even if there is no sensing object, the sensor will detect light that is reflected by the fluororesin.

Fiber Unit			Amplifier Unit	E3X-DA□-S (□: 21/51/7/9)				
Vacuum-resistance model				Sensing distance (unit: mm)				
Sensing method	Operating ambient temperature	Sensing direction	Model	Tough mode	High-resolution mode	Standard mode	High-speed mode	Super-high-speed mode
Through-beam models	120°C	Top view	E32-T51V 1M	720	520	400	260	100
			E32-T51V 1M + E39-F1V	3,780	2,700	2,000	1,360	520
	200°C	Right angle	E32-T54V 1M	580	420	250	200	70
			E32-T84SV 1M	1,760	1,250	950	640	260

For information on Fiber Units, refer to the Fiber Sensors Best Selection Catalog (Cat. No. E353).

## E3X-DA□-S (□: 21/51/7/9) ■ E3X-DA□F-S(□: 21/51/7/9)

Note: The E3X-DA□F-S uses only Super-high-speed mode. The sensing distance is the same as for the Super-high-speed mode of the E3X-DA□-S.

Fiber Unit			Amplifier Unit	E3X-DA□-S (□: 21/51/7/9)					
Long distance / Dust resistance (High-power), Detection through gaps (Narrow vision field)				Sensing distance (unit: mm)					
Sensing method	Type	Sensing direction / Lens type	Model	Tough mode	High-resolution mode	Standard mode	High-speed mode	Super-high- speed mode	
Through- beam models	High-power (integrated unit)	Top view	E32-T17L 10M	20,000 *1	20,000 *1	20,000 *1	20,000 *1	8,000	
		Side view	E32-T14 2M	4,000 *2	4,000 *2	4,000 *2	4,000 *2	1,800	
	High-power (with lens unit)	High-power		E32-T11N 2M + E39-F1	4,000 *2	4,000 *2	4,000 *2	4,000 *2	2,000
		Ultrahigh-power		E32-T11N 2M + E39-F16	4,000 *2	4,000 *2	4,000 *2	4,000 *2	3,600
		High-power		E32-T11R 2M + E39-F1	4,000 *2	4,000 *2	4,000 *2	4,000 *2	2,000
		Ultrahigh-power		E32-T11R 2M + E39-F16	4,000 *2	4,000 *2	4,000 *2	4,000 *2	3,600
		Side view		E32-T11R 2M + E39-F2	1,450	1,040	800	500	200
		High-power		E32-TC200 2M + E39-F1	4,000 *2	4,000 *2	4,000 *2	4,000 *2	3,000
		Ultrahigh-power		E32-TC200 2M + E39-F16	4,000 *2	4,000 *2	4,000 *2	4,000 *2	4,000 *2
		Side view		E32-TC200 2M + E39-F2	2,350	1,680	1,400	900	320
		High-power		E32-T11 2M + E39-F1	4,000 *2	4,000 *2	4,000 *2	4,000 *2	1,860
		Ultrahigh-power		E32-T11 2M + E39-F16	4,000 *2	4,000 *2	4,000 *2	4,000 *2	4,000 *2
		Side view		E32-T11 2M + E39-F2	2,300	1,640	1,320	860	320
		High-power		E32-T11U 2M + E39-F1	4,000 *2	4,000 *2	4,000 *2	4,000 *2	1,860
		Ultrahigh-power		E32-T11U 2M + E39-F16	4,000 *2	4,000 *2	4,000 *2	4,000 *2	4,000 *2
		Side view		E32-T11U 2M + E39-F2	2,300	1,640	1,320	860	320
		High-power		E32-T11NU 2M + E39-F1	4,000 *2	4,000 *2	4,000 *2	2,600	1,000
		Ultrahigh-power		E32-T11NU 2M + E39-F16	4,000 *2	4,000 *2	4,000 *2	4,000 *2	2,800
		High-power		E32-T81R-S 2M + E39-F1	4,000 *2	4,000 *2	4,000 *2	2,700	1,000
		Ultrahigh-power		E32-T81R-S 2M + E39-F16	4,000 *2	4,000 *2	4,000 *2	4,000 *2	1,800
		Side view		E32-T81R-S 2M + E39-F2	1,000	720	550	360	140
		High-power		E32-T61-S 2M + E39-F1	4,000 *2	4,000 *2	4,000 *2	4,000 *2	1,800
	Ultrahigh-power		E32-T61-S 2M + E39-F16	4,000 *2	4,000 *2	4,000 *2	4,000 *2	3,100	
	Side view		E32-T61-S 2M + E39-F2	1,680	1,200	900	600	240	
	Narrow vision field (aperture angle: 4°)	Top view		E32-T22S 2M	4,000 *2	4,000 *2	3,800	2,500	1,000
		Side view		E32-T24S 2M	4,000 *2	3,500	2,600	1,740	700
	Reflective models	High-power	Top view	E32-D16 2M	40 to 2,800	40 to 2,000	40 to 1,400	40 to 900	40 to 480

\*1. The fiber length is 10 m on each side, so the sensing distance is given as 20,000 mm.

\*2. The fiber length is 2 m on each side, so the sensing distance is given as 4,000 mm.

Fiber Unit			Amplifier Unit	E3X-DA□-S (□: 21/51/7/9)				
Minute object detection (Small-spot model)				Sensing distance (unit: mm)				
Sensing method	Spot diameter (mm)	Focal length (mm)	Model	Tough mode	High-resolution mode	Standard mode	High-speed mode	Super-high- speed mode
Reflective models	φ0.1 to 0.6 (Variable)	6 to 15	E32-C42 1M + E39-F3A	Spot diameter of 0.1 to 0.6 mm at 6 to 15 mm				
	φ0.3 to 1.6 (Variable)	10 to 30	E32-C42 1M + E39-F17	Spot diameter of 0.3 to 1.6 mm at 10 to 30 mm				
	φ0.1	5	E32-C42S 1M	Spot diameter of 0.1 mm at 5 mm				
		7	E32-C41 1M + E39-F3A-5	Spot diameter of 0.1 mm at 7 mm				
	φ0.2	17	E32-C41 1M + E39-F3B	Spot diameter of 0.2 mm at 17 mm				
		7	E32-C31 2M + E39-F3A-5	Spot diameter of 0.5 mm at 7 mm				
	φ0.5	17	E32-C31 2M + E39-F3B	Spot diameter of 0.5 mm at 17 mm				
		φ6	50	E32-L15 2M	Spot diameter of 6 mm at 50 mm Sensing distance in all mode (40 to 100 mm)			
	φ4 Parallel light	0 to 20	E32-C31 2M + E39-F3C	Spot diameter of 4 mm max. at 0 to 20 mm				
	φ3	50	E32-C11N 2M + E39-F18	Spot diameter of 3 mm at 50 mm				
E32-CC200 2M + E39-F18			Spot diameter of 3 mm at 50 mm					

Fiber Unit			Amplifier Unit	E3X-DA□-S (□: 21/51/7/9)				
Area-sensing (Area beam)				Sensing distance (unit: mm)				
Sensing method	Area range	Sensing direction	Model	Tough mode	High-resolution mode	Standard mode	High-speed mode	Super-high- speed mode
Through- beam models	11 mm	Side view	E32-T16PR 2M	3,100	2,200	1,700	1,120	440
		Flat view	E32-T16JR 2M	2,750	2,000	1,500	960	380
	30 mm	Side view	E32-T16WR 2M	4,000 *	3,400	2,600	1,700	680
Reflective models	11 mm	Side view	E32-D36P1 2M	700	500	300	200	90

\* The fiber length is 2 m on each side, so the sensing distance is given as 4,000 mm.

For information on Fiber Units, refer to the Fiber Sensors Best Selection Catalog (Cat. No. E353).



# E3X-DA-S

## E3X-DA□-S (□: 21/51/7/9) ■ E3X-DA□F-S(□: 21/51/7/9)

**Note:** The E3X-DA□F-S uses only Super-high-speed mode. The sensing distance is the same as for the Super-high-speed mode of the E3X-DA□-S.

Fiber Unit		Amplifier Unit		E3X-DA□-S (□: 21/51/7/9)				
Detection without background interference (Convergent-reflective)				Sensing distance (unit: mm)				
Sensing method	Sensing direction	Size	Model	Tough mode	High-resolution mode	Standard mode	High-speed mode	Super-high-speed mode
Reflective models	Flat view	Standard	E32-L16-N 2M *	0 to 15				0 to 12
		Small	E32-L24S 2M *	0 to 4				
	Top view	---	E32-L25L 2M *	5.4 to 9 (center 7.2)				
	Flat view		E32-L24L 2M *	2 to 6 (center 4)				

\* If operation is affected by the background, perform power tuning or set operation to ECO mode to reduce the amount of light that is received.

Fiber Unit		Amplifier Unit		E3X-DA□-S (□: 21/51/7/9)				
Detection of transparent objects (Retro-reflective)				Sensing distance (unit: mm)				
Sensing method	Type	Model		Tough mode	High-resolution mode	Standard mode	High-speed mode	Super-high-speed mode
Retro-reflective models	Square	E32-R16 5M + E39-R1 (attached) *1		150 to 1,500				
	Small	E32-R21 2M + E39-R3 (attached) *1		10 to 250				
	Film detection *2	E32-C31 2M + E39-F3R+E39-RP37 *1		250		200	---	
		E32-C31 2M + E39-F3R+E39-RSP1 *1		450		300	100	

\*1. When using a highly reflective object, light reflected from the object may affect the sensor.

\*2. The effect may be small due to the film. Also, stable detection may not be possible when there is a sensing object directly in front of the Lens Unit. Be sure to check operation in advance.

Fiber Unit		Amplifier Unit		E3X-DA□-S (□: 21/51/7/9)				
FPD / Semiconductor / Solar battery industry				Sensing distance (unit: mm)				
Sensing method	Application	Operating temperature	Model	Tough mode	High-resolution mode	Standard mode	High-speed mode	Super-high-speed mode
Reflective models	Glass detection	70°C	E32-L16-N 2M *	0 to 15				0 to 12
			E32-L16-N 2M *	0 to 15				0 to 12
	Glass substrate alignment	300°C	E32-A08 2M *	10 to 20				---
			E32-A08H2 3M *	10 to 20				---
	Glass substrate mapping	70°C	E32-A09 2M	15 to 38				---
		150°C	E32-A09H 2M	15 to 38				---
		300°C	E32-A09H2 2M	20 to 30				---
	WET process	60°C	E32-L11FP 5M	8 to 20 mm from end of lens (recommended: 11 mm)				
70°C		E32-L12FS 5M	8 to 20 mm from end of lens (recommended: 11 mm)					
85°C		E32-L11FS 5M	8 to 20 mm from end of lens (recommended: 11 mm)					
Through-beam models	Wafer mapping	70°C	E32-A03 2M	3,220	2,300	1,780	1,200	500
			E32-A03-1 2M	3,220	2,300	1,780	1,200	500
			E32-A04 2M	1,280	920	680	450	200
			E32-A04-1 2M	1,280	920	680	450	200

\* If operation is affected by the background, perform power tuning or set operation to ECO mode to reduce the amount of light that is received.

Fiber Unit		Amplifier Unit		E3X-DA□-S (□: 21/51/7/9)				
Liquid-level detection model				Sensing distance (unit: mm)				
Sensing method	Sensing direction	Pipe diameter	Model	Tough mode	High-resolution mode	Standard mode	High-speed mode	Super-high-speed mode
Reflective models	Mounted to pipe	No limit	E32-D36T 5M *1, *2	Applicable pipe: Transparent (no restriction on diameter)				
		φ8 to 10 mm	E32-L25T 2M	Applicable pipe: Transparent pipe with diameter of 8 to 10 mm, recommended pipe wall thickness: 1 mm				
	Wet	---	E32-D82F1 4M *1	Wet model				

\*1. If a high level of light is received, perform power tuning or set operation to ECO mode to reduce the amount of light that is received.

\*2. In Tough mode, detection may not be possible depending on the pipe diameter. Check operation with the pipe that will be used.

**For information on Fiber Units, refer to the Fiber Sensors Best Selection Catalog (Cat. No. E353).**



## E3X-DA□R-S (□: 21/51/7/9)

Fiber Unit				Amplifier Unit	E3X-DA□R-S (□: 21/51/7/9)				
Screw-shaped model				Sensing distance (unit: mm)					
Sensing method	Size	Sensing direction	Model	Tough mode	High-resolution mode	Standard mode	High-speed mode	Super-high-speed mode	
Through-beam models	M3	Straight	E32-T21R 2M	220	160	130	75	30	
		Right angle	E32-T11N 2M	1,000	700	500	350	140	
	M4	Straight	E32-T11R 2M	1,000	700	530	350	140	
			E32-TC200 2M	1,400	1,000	760	500	200	
		E32-T11L 2M	2,000	1,700	1,350	870	350		
Reflective models	M3	Right angle	E32-C31N 2M	55	40	25	23	7	
		Straight	E32-D21R 2M	70	50	30	20	8	
	E32-C31 2M		165	120	75	50	22		
	M4	Straight	E32-D211R 2M	70	50	30	20	8	
	M6		Right angle	E32-D11N 2M	420	300	175	120	50
		E32-C11N 2M		390	280	175	160	50	
		Straight	E32-D11R 2M	420	300	170	120	50	
			E32-DC200 2M	700	500	300	200	90	
	E32-CC200 2M	700	500	300	200	90			
	E32-D11L 2M	910	650	400	260	110			

Fiber Unit				Amplifier Unit	E3X-DA□R-S (□: 21/51/7/9)				
Flat model				Sensing distance (unit: mm)					
Sensing method	Sensing direction	Size	Model	Tough mode	High-resolution mode	Standard mode	High-speed mode	Super-high-speed mode	
Through-beam models	Top view	Standard	E32-T15XR 2M	1,000	700	530	350	140	
		Small	E32-T25XR 2M	220	160	130	75	30	
	Side view	Standard	E32-T15YR 2M	370	270	210	130	50	
		Small	E32-T25YR 2M	85	60	50	25	10	
	Flat view	Standard	E32-T15ZR 2M	370	270	210	130	50	
		Small	E32-T25ZR 2M	85	60	50	25	10	
Reflective models	Top view	Standard	E32-D15XR 2M	420	300	170	120	50	
		Small	E32-D25XR 2M	70	50	30	20	8	
	Side view	Standard	E32-D15YR 2M	100	70	40	26	12	
		Small	E32-D25YR 2M	20	14	8	5	2	
	Flat view	Standard	E32-D15ZR 2M	100	70	40	26	12	
		Small	E32-D25ZR 2M	20	14	8	5	2	

Fiber Unit				Amplifier Unit	E3X-DA□R-S (□: 21/51/7/9)				
Cylindrical model				Sensing distance (unit: mm)					
Sensing method	Sensing direction	Size	Model	Tough mode	High-resolution mode	Standard mode	High-speed mode	Super-high-speed mode	
Through-beam models	Top view	φ1	E32-T223R 2M	220	160	130	75	30	
		φ3	E32-T12R 2M	1,000	700	530	350	140	
	Side view	φ1	E32-T24R 2M	85	60	50	25	10	
		φ3	E32-T14LR 2M	370	270	210	130	50	
Reflective models	Top view	φ1.5	E32-D22B 2M	70	50	30	20	8	
		φ2	E32-D32 2M	160	120	75	50	22	
			E32-D22R 2M	70	50	30	20	8	
	Side view	φ3	E32-D32L 2M	350	250	150	100	45	
		φ2	E32-D24R 2M	35	26	15	10	4	
			φ6	E32-D14LR 2M	110	80	45	30	14

Fiber Unit				Amplifier Unit	E3X-DA□R-S (□: 21/51/7/9)				
Model equipped with sleeve				Sensing distance (unit: mm)					
Sensing method	Sleeve size	Mounting size	Model	Tough mode	High-resolution mode	Standard mode	High-speed mode	Super-high-speed mode	
Through-beam models	φ0.25 × 5	φ3	E32-T333-S5 1M	17	12	10	6	4	
	φ0.5 × 40		E32-T33 1M	75	55	45	25	10	
	φ0.9 × 40	M3	E32-TC200F4R 2M	220	160	130	75	30	
	φ1.2 × 90	M4	E32-TC200BR 2M	1,000	700	530	350	140	
Reflective models	φ0.5 × 15	φ2	E32-D331 2M	7	5	3	2	0.8	
	φ0.8 × 15	φ3	E32-D33 2M	35	25	16	10	4	
	φ1.2 × 40	M3	E32-DC200F4R 2M	70	50	30	20	8	
	φ2.5 × 90	M6	E32-DC200BR 2M	420	300	170	120	50	

For information on Fiber Units, refer to the Fiber Sensors Best Selection Catalog (Cat. No. E353).

# E3X-DA-S

## E3X-DA□R-S (□: 21/51/7/9)

Fiber Unit				Amplifier Unit		E3X-DA□R-S (□: 21/51/7/9)				
Movable section (Flexibility)				Sensing distance (unit: mm)						
Sensing method	Type	Size	Model	Tough mode	High-resolution mode	Standard mode	High-speed mode	Super-high-speed mode		
Through-beam models	Screw-shaped model	M3	E32-T21 2M	340	240	200	110	45		
		M4	E32-T11 2M	1,250	900	680	450	180		
	Cylindrical model	φ1.5	E32-T22B 2M	340	240	200	110	45		
		φ3	E32-T12B 2M	1,250	900	680	450	180		
	Flat model	Standard	E32-T15XB 2M	1,250	900	680	450	180		
Small		E32-T25XB 2M	250	180	150	85	35			
Reflective models	Screw-shaped model	M3	E32-D21 2M	70	50	30	20	8		
		M4	E32-D21B 2M	150	110	70	45	20		
		M6	E32-D11 2M	420	300	170	120	50		
	Cylindrical model	φ1.5	E32-D22B 2M	70	50	30	20	8		
		φ3	E32-D221B 2M	150	110	70	45	20		
	Flat model	Standard	E32-D15XB 2M	420	300	170	120	50		
		Small	E32-D25XB 2M	120	85	50	30	15		

Fiber Unit				Amplifier Unit		E3X-DA□R-S (□: 21/51/7/9)				
Heat-resistance model				Sensing distance (unit: mm)						
Sensing method	Operating temperature	Lens	Model	Tough mode	High-resolution mode	Standard mode	High-speed mode	Super-high-speed mode		
Through-beam models	100°C	---	E32-T51R 2M	800	560	425	280	110		
		Lens	E32-T51R 2M + E39-F1	4,000 *	3,900	2,900	1,900	760		
		High-power lens	E32-T51R 2M + E39-F16	4,000 *	4,000 *	4,000 *	3,600	1,400		
	150°C	---	E32-T51 2M	1,400	1,000	760	500	200		
		Lens	E32-T51 2M + E39-F1-33	4,000 *	3,400	2,660	1,150	700		
		High-power lens	E32-T51 2M + E39-F16	4,000 *	4,000 *	4,000 *	4,000 *	2,600		
	200°C	---	E32-T54 2M	420	300	230	150	60		
		Lens	E32-T81R-S 2M	500	360	280	180	70		
			E32-T61-S 2M	840	600	450	300	120		
	350°C	Lens	E32-T61-S 2M + E39-F1	4,000 *	4,000 *	3,400	2,200	900		
High-power lens		E32-T61-S 2M + E39-F16	4,000 *	4,000 *	4,000 *	3,900	1,500			
Reflective models	100°C	---	E32-D51R 2M	330	240	135	95	40		
	150°C		E32-D51 2M	560	400	230	160	72		
	200°C		E32-D81R 2M	210	150	90	60	27		
	350°C		E32-D61 2M	210	150	90	60	27		
	400°C		E32-D73 2M	140	100	60	40	18		

\* The fiber length is 2 m on each side, so the sensing distance is given as 4,000 mm.

Fiber Unit				Amplifier Unit		E3X-DA□R-S (□: 21/51/7/9)				
Chemical-resistance / Oil-resistance model				Sensing distance (unit: mm)						
Sensing method	Type	Model	Tough mode	High-resolution mode	Standard mode	High-speed mode	Super-high-speed mode			
Through-beam models	φ5	E32-T12F 2M	4,000 *1	4,000 *1	3,000	2,000	800			
	φ7.2	E32-T11F 2M	3,500	2,500	2,000	1,300	520			
	φ5	E32-T51F 2M	2,500	1,800	1,400	900	350			
	φ5	E32-T14F 2M	700	500	400	250	100			
	M4	E32-T11U 2M	1,250	900	680	450	180			
	M4	E32-T11NU 2M	720	520	400	260	100			
Reflective models	φ6	E32-D12F 2M	---	160	95	65	30			
	φ7	E32-D14F 2M	---	70	40	30	10			
	M6	E32-D11U 2M	420	300	170	120	50			

\*1. The fiber length is 2 m on each side, so the sensing distance is given as 4,000 mm.

\*2. The sensor will detect light even if there is no sensing object, and so Tough Mode cannot be used.

Fiber Unit				Amplifier Unit		E3X-DA□R-S (□: 21/51/7/9)				
Vacuum-resistance model				Sensing distance (unit: mm)						
Sensing method	Operating ambient temperature	Sensing direction	Model	Tough mode	High-resolution mode	Standard mode	High-speed mode	Super-high-speed mode		
Through-beam models	120°C	Top view	E32-T51V 1M	360	260	200	130	50		
			E32-T51V 1M + E39-F1V	1,890	1,350	1,000	680	260		
	200°C	Right angle	E32-T54V 1M	290	210	130	100	35		
			E32-T84SV 1M	880	630	480	320	130		

For information on Fiber Units, refer to the Fiber Sensors Best Selection Catalog (Cat. No. E353).

## E3X-DA□R-S (□: 21/51/7/9)

Fiber Unit			Amplifier Unit	E3X-DA□R-S (□: 21/51/7/9)					
Long distance / Dust resistance (High-power), Detection through gaps (Narrow vision field)				Sensing distance (unit: mm)					
Sensing method	Type	Sensing direction / Lens type	Model	Tough mode	High-resolution mode	Standard mode	High-speed mode	Super-high- speed mode	
Through- beam models	High-power (integrated unit)	Top view	E32-T17L 10M	20,000 *1	20,000 *1	20,000 *1	10,000	4,000	
		Side view	E32-T14 2M	4,000 *2	4,000 *2	3,400	2,250	900	
	High-power (with lens unit)	High-power		E32-T11N 2M + E39-F1	4,000 *2	4,000 *2	3,700	2,400	970
			Ultra-high-power	E32-T11N 2M + E39-F16	4,000 *2	4,000 *2	4,000 *2	4,000 *2	1,800
		High-power		E32-T11R 2M + E39-F1	4,000 *2	4,000 *2	3,700	2,400	970
			Ultra-high-power	E32-T11R 2M + E39-F16	4,000 *2	4,000 *2	4,000 *2	4,000 *2	1,800
		Side view		E32-T11R 2M + E39-F2	725	520	400	250	100
			High-power	E32-TC200 2M + E39-F1	4,000 *2	4,000 *2	4,000 *2	2,600	1,500
		Ultra-high-power		E32-TC200 2M + E39-F16	4,000 *2	4,000 *2	4,000 *2	4,000 *2	4,000 *2
			Side view	E32-TC200 2M + E39-F2	1,170	840	700	450	160
		High-power		E32-T11 2M + E39-F1	4,000 *2	4,000 *2	3,600	2,300	930
			Ultra-high-power	E32-T11 2M + E39-F16	4,000 *2	4,000 *2	4,000 *2	4,000 *2	2,300
		Side view		E32-T11 2M + E39-F2	1,150	820	660	430	160
			High-power	E32-T11U 2M + E39-F1	4,000 *2	4,000 *2	3,600	2,300	930
		Ultra-high-power		E32-T11U 2M + E39-F16	4,000 *2	4,000 *2	4,000 *2	4,000 *2	2,300
			Side view	E32-T11U 2M + E39-F2	1,150	820	660	430	160
		High-power		E32-T11NU 2M + E39-F1	4,000 *2	2,600	2,000	1,300	500
			Ultra-high-power	E32-T11NU 2M + E39-F16	4,000 *2	4,000 *2	4,000 *2	3,300	1,300
		High-power		E32-T81R-S 2M + E39-F1	4,000 *2	2,650	2,100	1,300	520
			Ultra-high-power	E32-T81R-S 2M + E39-F16	4,000 *2	4,000 *2	3,600	2,300	900
		Side view		E32-T81R-S 2M + E39-F2	500	360	280	180	70
			High-power	E32-T61-S 2M + E39-F1	4,000 *2	4,000 *2	3,400	2,200	900
	Ultra-high-power		E32-T61-S 2M + E39-F16	4,000 *2	4,000 *2	4,000 *2	3,900	1,500	
		Side view	E32-T61-S 2M + E39-F2	840	600	450	300	120	
	Narrow vision field (aperture angle: 4°)	High-power	Top view	E32-T22S 2M	3,500	2,500	1,900	1,250	500
			Side view	E32-T24S 2M	2,400	1,750	1,300	870	350
	Reflective models	High-power	Top view	E32-D16 2M	40 to 1,400	40 to 1,000	40 to 700	40 to 450	40 to 240

\*1. The fiber length is 10 m on each side, so the sensing distance is given as 20,000 mm.

\*2. The fiber length is 2 m on each side, so the sensing distance is given as 4,000 mm.

Fiber Unit			Amplifier Unit	E3X-DA□R-S (□: 21/51/7/9)				
Minute object detection (Small-spot model)				Sensing distance (unit: mm)				
Sensing method	Spot diameter (mm)	Focal length (mm)	Model	Tough mode	High-resolution mode	Standard mode	High-speed mode	Super-high- speed mode
Reflective models	φ0.1 to 0.6 (Variable)	6 to 15	E32-C42 1M + E39-F3A	Spot diameter of 0.1 to 0.6 mm at 6 to 15 mm				
	φ0.3 to 1.6 (Variable)	10 to 30	E32-C42 1M + E39-F17	Spot diameter of 0.3 to 1.6 mm at 10 to 30 mm				
	φ0.1	5	E32-C42S 1M	Spot diameter of 0.1 mm at 5 mm				
		7	E32-C41 1M + E39-F3A-5	Spot diameter of 0.1 mm at 7 mm				
	φ0.2	17	E32-C41 1M + E39-F3B	Spot diameter of 0.2 mm at 17 mm				
		7	E32-C31 2M + E39-F3A-5	Spot diameter of 0.5 mm at 7 mm				
	φ0.5	17	E32-C31 2M + E39-F3B	Spot diameter of 0.5 mm at 17 mm				
		φ6	50	E32-L15 2M	Spot diameter of 6 mm at 50 mm Sensing distance in all mode (40 to 100 mm)			
	φ4 Parallel light	0 to 20	E32-C31 2M + E39-F3C	Spot diameter of 4 mm max. at 0 to 20 mm				
	φ3	50	E32-C11N 2M + E39-F18	Spot diameter of 3 mm at 50 mm				
E32-CC200 2M + E39-F18			Spot diameter of 3 mm at 50 mm					

Fiber Unit			Amplifier Unit	E3X-DA□R-S (□: 21/51/7/9)				
Area-sensing (Area beam)				Sensing distance (unit: mm)				
Sensing method	Area range	Sensing direction	Model	Tough mode	High-resolution mode	Standard mode	High-speed mode	Super-high- speed mode
Through- beam models	11mm	Side view	E32-T16PR 2M	1,550	1,100	840	560	220
		Flat view	E32-T16JR 2M	1,370	980	750	480	190
	30mm		E32-T16WR 2M	2,000	1,700	1,300	850	340
Reflective models	11mm	Side view	E32-D36P1 2M	350	250	150	100	45

For information on Fiber Units, refer to the Fiber Sensors Best Selection Catalog (Cat. No. E353).

# E3X-DA-S

## E3X-DA□R-S (□: 21/51/7/9)

Fiber Unit		Amplifier Unit		E3X-DA□R-S (□: 21/51/7/9)				
Detection without background interference (Convergent-reflective)				Sensing distance (unit: mm)				
Sensing method	Sensing direction	Size	Model	Tough mode	High-resolution mode	Standard mode	High-speed mode	Super-high-speed mode
Reflective models	Flat view	Standard	E32-L16-N 2M *	0 to 15				0 to 12
		Small	E32-L24S 2M *	0 to 4				
	Top view	---	E32-L25L 2M *	5.4 to 9 (center 7.2)				
	Flat view	---	E32-L24L 2M *	2 to 6 (center 4)				

\* If operation is affected by the background, perform power tuning to reduce the amount of light that is received.

Fiber Unit		Amplifier Unit		E3X-DA□R-S (□: 21/51/7/9)				
Detection of transparent objects (Retro-reflective)				Sensing distance (unit: mm)				
Sensing method	Type	Model		Tough mode	High-resolution mode	Standard mode	High-speed mode	Super-high-speed mode
Retro-reflective models	Square	E32-R16 5M + E39-R1 (attached) *1		150 to 1,500				
	Small	E32-R21 2M + E39-R3 (attached) *1		10 to 250				
	Film detection *2	E32-C31 2M + E39-F3R+E39-RP37 *1		250	200	150	100	50
		E32-C31 2M + E39-F3R+E39-RSP1 *1		600	300	225	150	75

\*1. When using a highly reflective object, light reflected from the object may affect the sensor.

\*2. The effect may be small due to the film. Also, stable detection may not be possible when there is a sensing object directly in front of the Lens Unit. Be sure to check operation in advance.

Fiber Unit		Amplifier Unit		E3X-DA□R-S (□: 21/51/7/9)				
FPD / Semiconductor / Solar battery industry				Sensing distance (unit: mm)				
Sensing method	Application	Operating temperature	Model	Tough mode	High-resolution mode	Standard mode	High-speed mode	Super-high-speed mode
Reflective models	Glass detection	70°C	E32-L16-N 2M *	0 to 15				0 to 12
			E32-L16-N 2M *	0 to 15				0 to 12
	Glass substrate alignment	300°C	E32-A08 2M *	10 to 20				
			E32-A08H2 3M *	10 to 20				
	Glass substrate mapping	70°C	E32-A09 2M	15 to 38				
		150°C	E32-A09H 2M	15 to 38				
		300°C	E32-A09H2 2M	20 to 30				
	WET process	60°C	E32-L11FP 5M	8 to 20 mm from end of lens (recommended: 11 mm)				
70°C		E32-L12FS 5M	8 to 20 mm from end of lens (recommended: 11 mm)					
85°C		E32-L11FS 5M	8 to 20 mm from end of lens (recommended: 11 mm)					
Through-beam models	Wafer mapping	70°C	E32-A03 2M	1,610	1,150	890	600	250
			E32-A03-1 2M	1,610	1,150	890	600	250
			E32-A04 2M	640	460	340	225	100
			E32-A04-1 2M	640	460	340	225	100

\* If operation is affected by the background, perform power tuning to reduce the amount of light that is received.

Fiber Unit		Amplifier Unit		E3X-DA□R-S (□: 21/51/7/9)				
Liquid-level detection model				Sensing distance (unit: mm)				
Sensing method	Sensing direction	Pipe diameter	Model	Tough mode	High-resolution mode	Standard mode	High-speed mode	Super-high-speed mode
Reflective models	Mounted to pipe	No limit	E32-D36T 5M *	Applicable pipe: Transparent (no restriction on diameter)				
		φ8 to 10mm	E32-L25T 2M	Applicable pipe: Transparent pipe with diameter of 8 to 10 mm, recommended pipe wall thickness: 1 mm				
	Wet	---	E32-D82F1 4M *	Wet model				

\* If a high level of light is received, perform power tuning to reduce the amount of light that is received.

For information on Fiber Units, refer to the Fiber Sensors Best Selection Catalog (Cat. No. E353).

# I/O Circuit Diagrams

## NPN Output

Model	Operation mode	Timing charts	Operation selector	Output circuit
E3X-DA21-S E3X-DA21R-S E3X-DA21F-S	Light-ON	ch1/ Incident light ch2 No incident light Operation indicator ON (orange) OFF Output transistor ON OFF Load Operate (e.g., relay) Reset (Between brown and black (orange) leads)	LIGHT ON (L-ON)	<b>E3X-DA21-S</b> <p>*1. For the E3X-DA21R-S, this is the APC alarm output. This output does not exist on the E3X-DA21F-S. *2. This input does not exist the E3X-DA21F-S.</p>
	Dark-ON	ch1/ Incident light ch2 No incident light Operation indicator ON (orange) OFF Output transistor ON OFF Load Operate (e.g., relay) Reset (Between brown and black (orange) leads)	DARK ON (D-ON)	
E3X-DA7-S E3X-DA7R-S E3X-DA7F-S	Light-ON	ch1/ Incident light ch2 No incident light Operation indicator ON (orange) OFF Output transistor ON OFF Load Operate (e.g., relay) Reset (Between brown and black (orange) leads)	LIGHT ON (L-ON)	<b>E3X-DA7-S</b> <p>* For the E3X-DA7R-S, this is the APC alarm output. This output does not exist on the E3X-DA7F-S.</p>
	Dark-ON	ch1/ Incident light ch2 No incident light Operation indicator ON (orange) OFF Output transistor ON OFF Load Operate (e.g., relay) Reset (Between brown and black (orange) leads)	DARK ON (D-ON)	

## PNP Output

Model	Operation mode	Timing charts	Operation selector	Output circuit
E3X-DA51-S E3X-DA51R-S E3X-DA51F-S	Light-ON	ch1/ Incident light ch2 No incident light Operation indicator ON (orange) OFF Output transistor ON OFF Load Operate (e.g., relay) Reset (Between blue and black (orange) leads)	LIGHT ON (L-ON)	<b>E3X-DA51-S</b> <p>*1. For the E3X-DA51R-S, this is the APC alarm output. This output does not exist on the E3X-DA51F-S. *2. This input does not exist the E3X-DA51F-S.</p>
	Dark-ON	ch1/ Incident light ch2 No incident light Operation indicator ON (orange) OFF Output transistor ON OFF Load Operate (e.g., relay) Reset (Between blue and black (orange) leads)	DARK ON (D-ON)	
E3X-DA9-S E3X-DA9R-S E3X-DA9F-S	Light-ON	ch1/ Incident light ch2 No incident light Operation indicator ON (orange) OFF Output transistor ON OFF Load Operate (e.g., relay) Reset (Between blue and black (orange) leads)	LIGHT ON (L-ON)	<b>E3X-DA9-S</b> <p>* For the E3X-DA9R-S, this is the APC alarm output. This output does not exist on the E3X-DA9F-S.</p>
	Dark-ON	ch1/ Incident light ch2 No incident light Operation indicator ON (orange) OFF Output transistor ON OFF Load Operate (e.g., relay) Reset (Between blue and black (orange) leads)	DARK ON (D-ON)	

**Note:** 1. Operation with area settings is as follows:  
 LIGHT ON: ON when the incident level is between the thresholds for channels 1 and 2.  
 DARK ON: OFF when the incident level is between the thresholds for channels 1 and 2.

### 2. Timing Charts for Timer Settings (T: Set Time)

ON delay	OFF delay	One-shot	ON delay and OFF delay

T<sub>1</sub>: ON-delay set time  
 T<sub>2</sub>: OFF-delay set time  
 T<sub>1</sub> and T<sub>2</sub> can be set separately.

# E3X-DA-S

## Nomenclature

### Amplifier Units

E3X-DA□-S (□: 21/51/7/9)

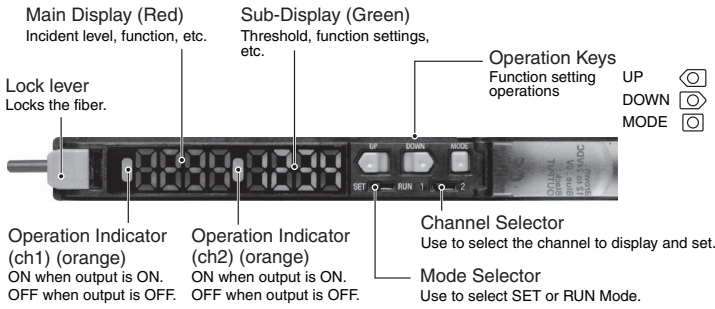

**Note:** Nomenclature and operating procedures for the E3X-DA□R-S and E3X-DA□F-S (□: 21/51/7/9) are given on pages 19 and 20.

## Operating Procedure

### 1 Setting the Operation Mode

The operation mode is set in SET Mode.  
 → Refer to 5. Setting Functions on page 16.

Set the Channel Selector Switch to the desired channel before making any adjustments or settings.

### 2 Adjusting the Power (RUN Mode)

The current incident light level can be adjusted near the power tuning target value (default: 2,000).

- \* Confirm that the MODE Key setting is PTUN (power tuning). The default setting is PTUN.  
 → Refer to 5. Setting Functions on page 16.
- \* If power tuning is executed while SHS is selected for the detection function, the minimum power will be set.

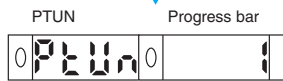

Release the key after the progress bar is displayed.

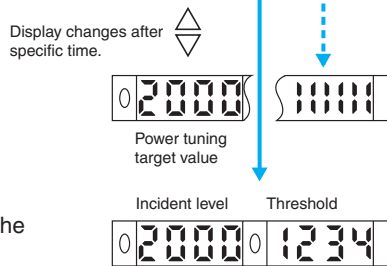

This completes the adjustment.

To restore the default power setting:

\* Press the DOWN Key right after pressing the MODE Key.

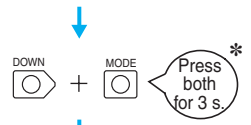

"OFF" will flash twice.

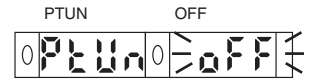

This restores the default setting.



#### \* Setting Errors

An error has occurred if one of the following displays appears after the progress bar is displayed.

Display	Error	Action
Flashes twice  PTUN OVER	<b>Over Error</b> The incident light level is too low for the power tuning target value.	The power will not be tuned. The power can be increased up to approximately 5 times the incident light value.
Flashes twice  PTUN BOTM	<b>Bottom Error</b> The incident light level is too high for the power tuning target value.	The power will be turned to the minimum level. The power can be decreased down to approximately 1/20th the incident light value.

### 3 Setting Thresholds Manually (RUN Mode)

A threshold can be set manually. A threshold can also be adjusted manually after teaching to fine-tune it.

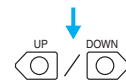

Increases threshold. Decreases threshold.

\* Even if the display method is changed, the threshold will appear on the sub-display when the key is pressed.



4 Teaching the Threshold (SET Mode)

- \* There are five methods that can be used for teaching, as described below. Use the method most suitable for the application.
- \* Two-point teaching, positioning teaching, and automatic teaching can be performed in RUN Mode. For operating procedures, refer to the *Instruction Manual* provided with the product.
- \* An error has occurred if OVER or LO is displayed on the sub-display. If that occurs, repeat the operation from the beginning.

4-1. Setting the Threshold at Maximum Sensitivity

The threshold can be set to the maximum sensitivity. This is useful when the longest detection distance is required.

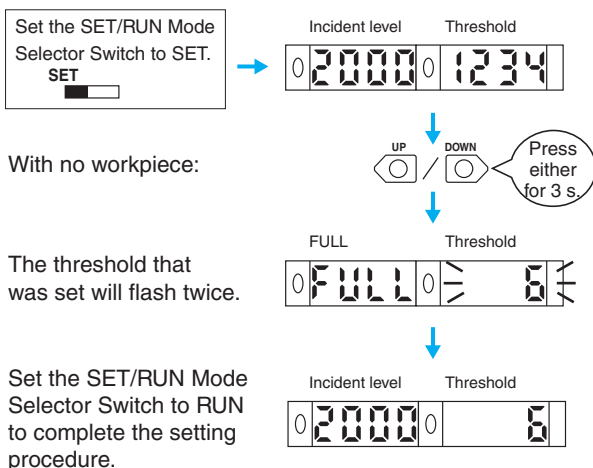

4-2. Teaching a Through-beam Fiber Unit without a Workpiece

You can set the threshold to below the incident light level without a workpiece by the percentage set for the teaching level.

→ Refer to 5. Setting Functions on page 16.

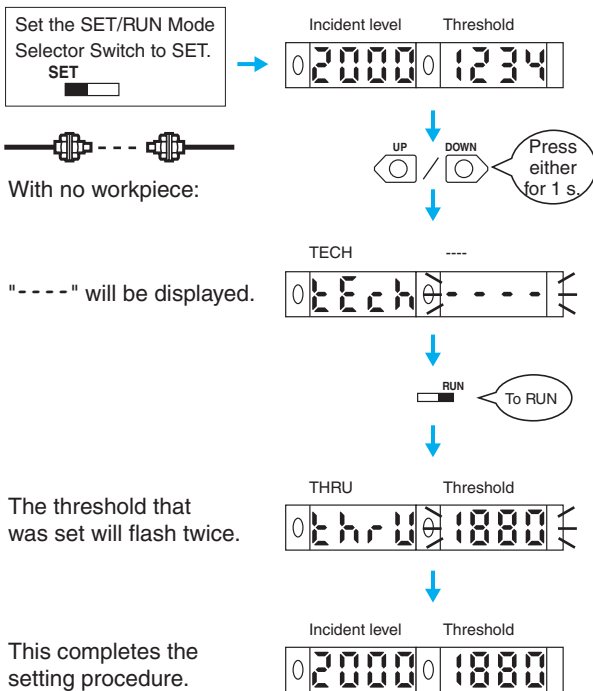

4-3. Teaching a Reflective Fiber Unit without a Workpiece

You can set the threshold to above the incident light level without a workpiece by the percentage set for the teaching level.

→ Refer to 5. Setting Functions on page 16.

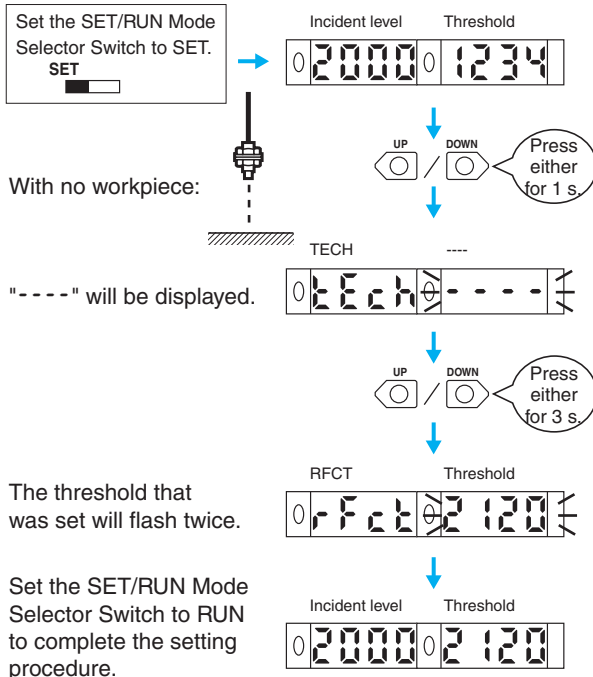

4-4. Two-point Teaching

4-5. Positioning Teaching

Two points in the following figures are detected, and the intermediate point of the light levels for the two points is set as the threshold.

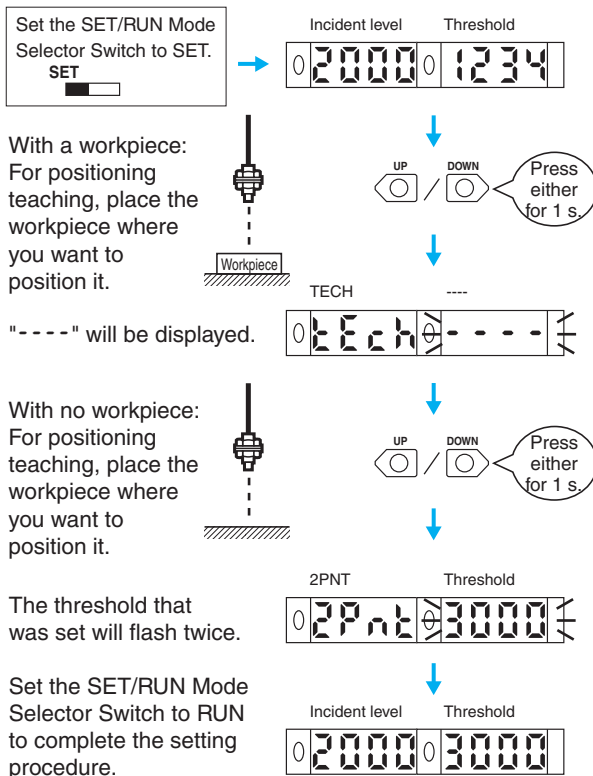



5 Setting Functions (SET Mode)

\* The function transition boxes show the default settings.  
 \* More functions may be displayed depending on the detailed settings.

Moving between Functions → Refer to 4. Teaching the Threshold on page 15.

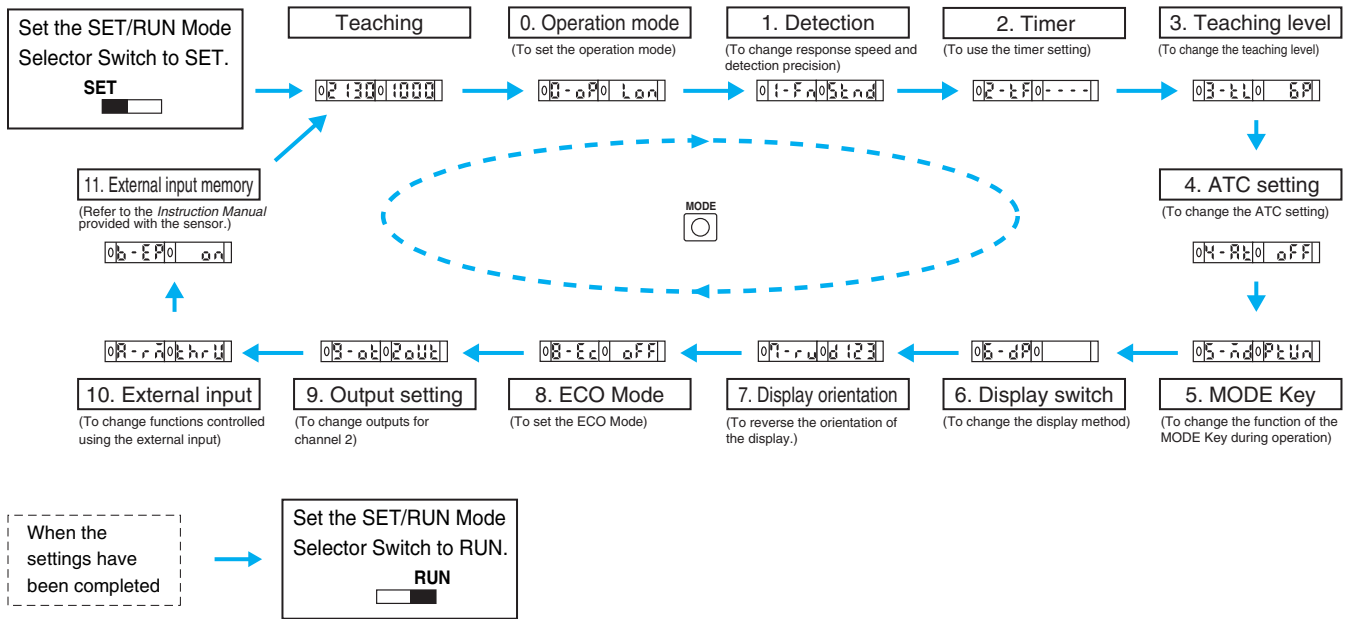











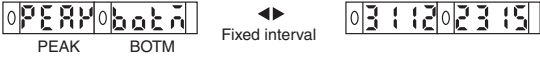

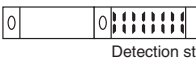











Functions

Use the UP and DOWN Keys to change the settings.

Function *	Setting (display)	Description
0. Operation mode	Light ON: L0n, Dark ON: d0n	→ Refer to 1. Setting the Operation Mode on page 14.
1. Detection *	Super-high-speed: 5H5, High-speed: H5, Standard: 5kn, High-resolution: HrE5, Tough: k9, Differential operation: dIFf	Used to change the response speed or detection precision.
	Differential edge (differential operation selected) Single edge: _f~, Double edge: _n_	Used to set the edge to be detected.
	Differential time Single edge...250 μs: 1, 500 μs: 2, 1 ms: 3, 10 ms: 4, 100 ms: 5, Double edge...500 μs: 1, 1 ms: 2, 2 ms: 3, 20 ms: 4, 200 ms: 5	Used to set the differential response time.
2. Timer	Timer disabled: - - - -, OFF-delay timer: 0FFd, ON-delay timer: 0n-d, One-shot timer: !5hk ON-delay + OFF-delay timer: 0n0F	Used to enable or disable timers.
	Time (timer enabled) 1 to 20 ms: 1-ms increments, 20 to 200 ms: 10-ms increments, 200 ms to 1 s: 100-ms increments, 1 to 5 s: 1-s increments	Used to change timer settings when timers are enabled. The timer can be set from 1 to 5,000 ms.
3. Teaching level	Setting range: 0P to 99P	Used to change the threshold setting when teaching a Through-beam Fiber Unit without a workpiece or teaching a Reflective Fiber Unit without a workpiece.
4. ATC setting	ATC enabled: 0n, ATC disabled: 0FF	Used to enable or disable the ATC function.
	Setting at Power-ON (ATC ON) No setting: 0FF, ATC start processing: Rkc, Power tuning and ATC start processing: PkRk	Used to set the processing to be performed when the power is turned ON.
5. MODE Key *	Executes power tuning: Pkkn, Executes a zero reset: 0r5k, Two-point teaching: 2Pnk, Automatic teaching: Rkk0, ATC start: Rkc	Used to change the function of the MODE Key during RUN operation.
	Power tuning target value (performing power tuning) Setting range: 100 to 3,900 (increments of 100) Maximum power: Fkkk	Used to set target values during power tuning. → Refer to 2. Adjusting the Power on page 14.

\* The detection settings and MODE Key settings are the same for channel 1 and channel 2. Other functions can be set separately for each channel.

Function	Setting (display)	Description
6. Display switch	 Incident level Threshold	Used to display the incident light level and the threshold.
	 % incident level Threshold	Used to display the incident light level as a percentage of the threshold and the threshold.
	 PEAK BOTM Fixed interval	Used to display the peak and bottom levels of incident light within a set time. (Updated every 2 s.)
	 L-PE D-BT	Use to display the incident light peak level and no incident light bottom level. (Refreshed when output turns ON or OFF.)
	 Detection status	Analog bar display. The current detection status is displayed as an analog bar. The bar will lengthen from the right as ON status is reached. (ON: Red, OFF: Green)
	 Current incident level PEAK Fixed interval Current incident level Peak incident level	Used to display the current incident light level and the peak incident light level. Display changes at a fixed interval.
	 Incident level Channel (unit number)	Used to display the incident light level and the channel (unit number).
7. Display orientation	Normal display:  123, Up/down reversed display:  123 P	Used to reverse the orientation of the display.
8. ECO Mode	Lit digital display:  FF, Dimmed digital display:  c d i, OFF:  c d z	Used to enable or disable the ECO mode.
9. Output setting	Each channel:  u u t, Output when the incident light level is between two thresholds:  r r e r, Self-diagnosis output:  s e l f	Used to change the output details for channel 2. This setting will be disabled if the detection function is set to DIFF (i.e., differential operation) and the output will be used for an alarm output.
10. External input	Through-beam, no-workpiece teaching:  h r u, Reflective, no-workpiece teaching:  r f c t, Two-point teaching:  z p n t, Automatic teaching:  a u t o, Power tuning:  p t u n, Zero reset:  z r s t, Light OFF:  l o f f, ATC start:  a t c s	Used to change the functions to be controlled using the external input. (Refer to the <i>Instruction Manual</i> provided with the sensor.)
11. External input memory	Write results to EEPROM:  o n, Do not write results to EEPROM:  o f f	Used to set writing the results. (Refer to <i>Instruction Manual</i> provided with the product.)

6 Convenient Functions

6-1. Setting the Digital Display to Zero (Zero Reset)

The incident light level on the main display can be set to 0. The incident light level and the threshold will both be shifted. This is useful when you want to set the reference display to zero.

\* Change the function to 0RST (zero reset) with the MODE Key. The default setting is PTUN.  
 → Refer to 5. Setting Functions on page 16.

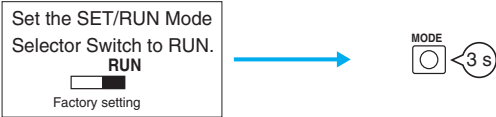

To return to original value for incident light level:

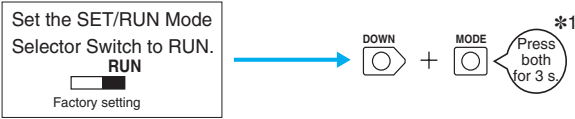

6-2. Locking the Keys (Key Lock)

All key operations can be disabled.



“LOC ON” will flash twice and key operations will be disabled.

To release the lock:

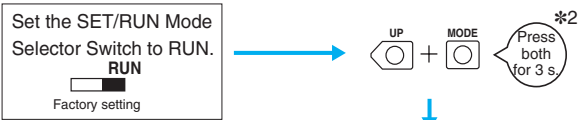

“LOC OFF” will flash twice and key operations will be enabled.

\* If a key is pressed while key operations are locked, “LOC ON” will flash twice on the display to indicate that key operations have been disabled.

\*1. Press the DOWN Key right after pressing the MODE Key.  
 \*2. Press the UP Key right after pressing the MODE Key.

6-3. Resetting Settings (Initial Reset or User Reset)

All settings can be returned to the factory defaults or to user-saved settings.

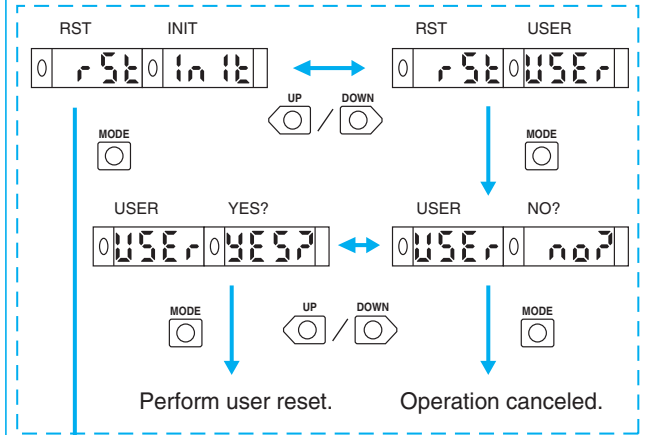

(The steps within the dotted lines can be used if settings have been saved by the user.)

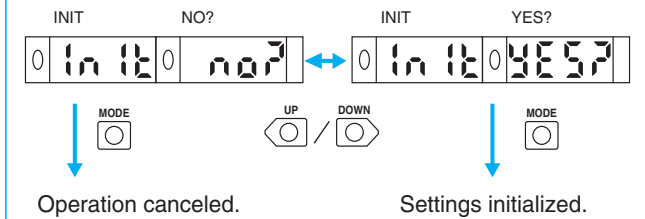

Saving User Settings

The current settings can be saved.

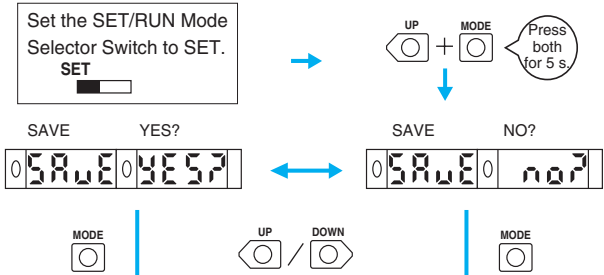

The current settings are saved. Operation canceled.

# Nomenclature

## Amplifier Units

E3X-DA□R-S (□: 21/51/7/9)

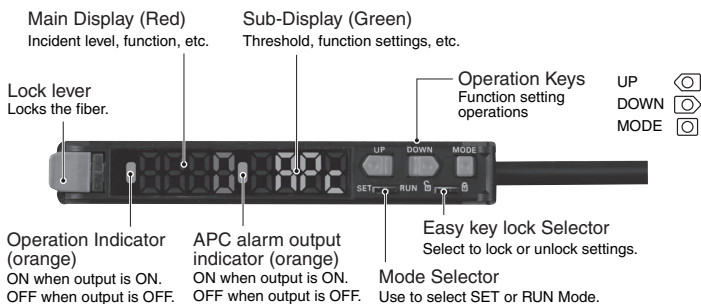

## Operating Procedure

Basic operating procedures are given on pages 14 to 18. For details, refer to the Instruction Manual provided with the product. This section shows functions specific to the E3X-DA□R-S.

### 1 Locking the Keys (Easy Key Lock)

Before shipment, all key operation except for the MODE Keys can be disabled.

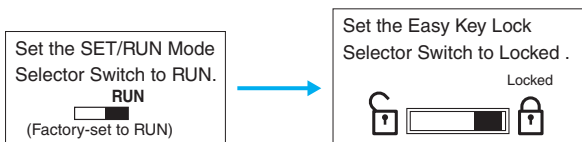

**Note:** Do not switch the lock while in SET Mode. Doing so will disable changing settings. If the lock is switched to in SET Mode, return to the unlock state, and then make the setting again.

#### Unlocking

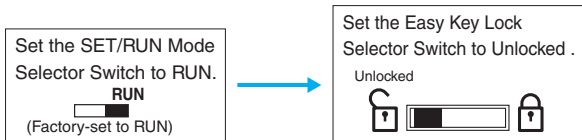

### 2 Displaying the APC Margin

Displaying the APC margin can be useful for planning maintenance. When the APC margin is 0%, APC alarm output will turn ON, and the APC alarm output indicator will light regardless of the operation of the APC margin display.

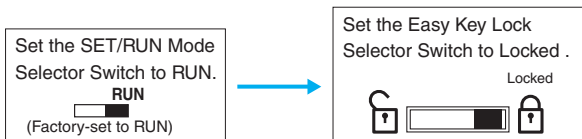

Press the MODE Key to display the following for 10 s.

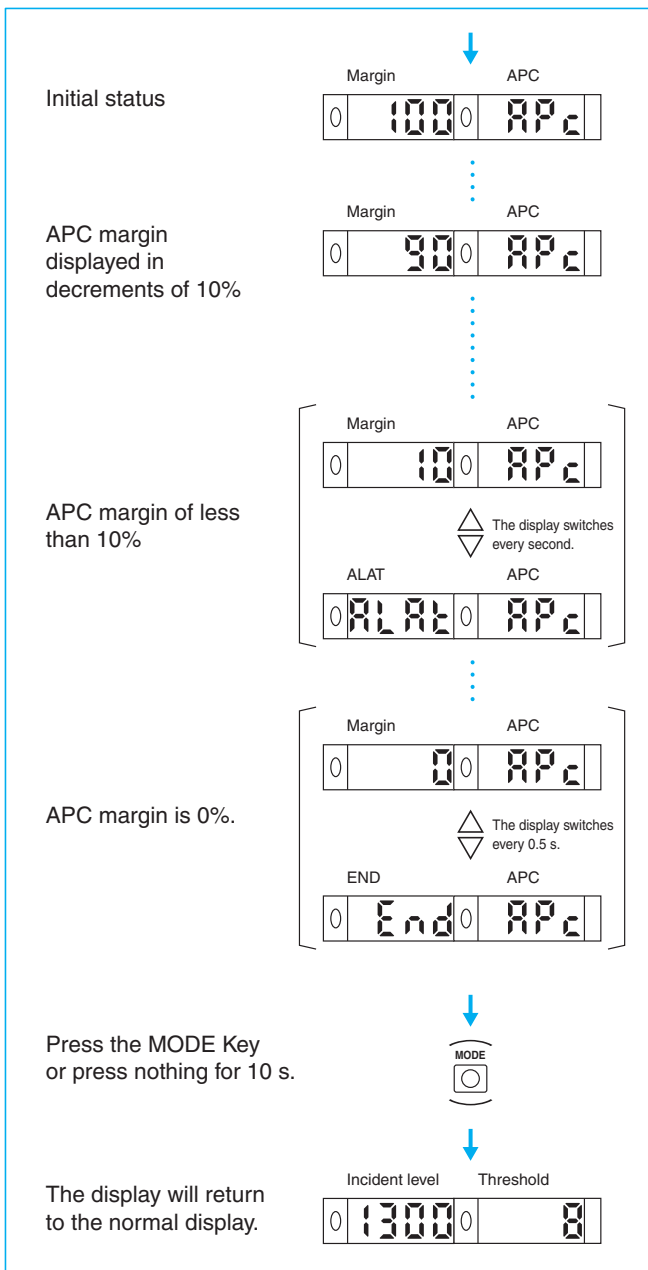

# E3X-DA-S

## Nomenclature

### Amplifier Units

E3X-DA□F-S (□: 21/51/7/9)

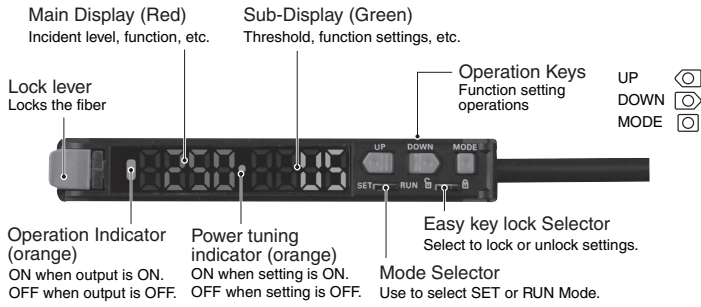

## Operating Procedure

Basic operating procedures are as given on pages 14 to 18. For details, refer to the Instruction Manual provided with the product. This section shows functions specific to the E3X-DA□F-S.

### 1 Locking the Keys (Easy Key Lock)

Before shipment, all key operation except for the MODE Keys can be disabled.

Set the SET/RUN Mode Selector Switch to RUN.  
**RUN**  
(Factory-set to RUN)

Set the Easy Key Lock Selector Switch to Locked.  
Locked

**Note:** Do not switch the lock while in SET Mode. Doing so will disable changing settings. If the lock is switched to in SET Mode, return to the unlock state, and then make the setting again.

**Unlocking**

Set the SET/RUN Mode Selector Switch to RUN.  
**RUN**  
(Factory-set to RUN)

Set the Easy Key Lock Selector Switch to Unlocked.  
Unlocked

### 2 Displaying the Change of the incident level

Changes of the incident level for high-speed workpiece detection can be displayed. This enables checking the margin level of light received and the workpiece ON time in slow motion.

Set the SET/RUN Mode Selector Switch to RUN.  
**RUN**  
(Factory-set to RUN)

Set the Easy Key Lock Selector Switch to Locked.  
Locked

Turn OFF the output or convey the workpieces.

Incident level    Threshold  
0 3112 ◦ 2000

MODE

Press the MODE key.

"A" is displayed when the output is ON or until approximately 10 s has elapsed. (Key operations will not be accepted in the status.)

A

STAT

"STAT" will be displayed and the slow-motion display will start.

The incident level in intervals of 17  $\mu$ s will be displayed for approximately 20 s every 160 ms (between 0.5 ms before ON to 1.5 ms after ON).

Incident level    Threshold  
0 3112 ◦ 2000

Incident level    Threshold  
0 1000 ◦ 2000

Incident level    Threshold  
0 2000 ◦ 2000

Press the MODE Key, or wait for the slow-motion display to end.

MODE

The output ON time will be displayed.

Output ON time    Unit:  $\mu$ s  
0 250 ◦ 05

END will be displayed.

END

The display will return to the normal display.

Incident level    Threshold  
0 3112 ◦ 2000

<b>Error Display</b>	The following will be displayed if the ON time exceeds 1,500 $\mu$ s.	The following will be displayed if the change in the light amount is low. *	* This may also be displayed when detecting a workpiece with a small change in light amount or a slow workpiece of 1,500 $\mu$ s or longer.
	OVER    US 	NON    DETC 	

## Safety Precautions

To ensure safe operation, be sure to read and follow the *Instruction Manual* provided with the sensor.

### WARNING

This product is not designed or rated for ensuring safety of persons either directly or indirectly. Do not use it for such purposes.



### CAUTION

Do not use the sensor with voltage in excess of the rated voltage. Excess voltage may result in malfunction or fire.



Never use the sensor with an AC power supply. Otherwise, explosion may result.



### Precautions for Safe Use

The following precautions must be observed to ensure safe operation of the sensor.

1. Do not use the sensor in an environment where explosive or flammable gas is present.
2. Do not use the sensor in a location subject to splattering with water, streams, oils, or chemicals.
3. Do not attempt to disassemble, repair, or modify the sensor.
4. Do not apply voltages or currents that exceed the rated range to the sensor.
5. Do not use the sensor in an ambient atmosphere or environment that exceeds the ratings.
6. Wire the power supply correctly, including the polarity.
7. Connect the load correctly.
8. Do not short-circuit the load at both ends.
9. Do not use the sensor if the case is damaged.
10. Dispose of the sensor as industrial waste.
11. Do not use the sensor in locations subject to direct sunlight.

### Precautions for Correct Use

Do not use the product in atmospheres or environments that exceed product ratings.

## Amplifier Unit

### Designing

#### Operation after Turning Power ON

The sensor is ready to detect within 200 ms after the power supply is turned ON. If the sensor and load are connected to separate power supplies, be sure to turn ON the sensor first.

Time may be required for the incident level to stabilize after the power supply is turned ON.

#### Operation at Power OFF

A pulse may be output when the power supply is turned OFF. Turn OFF the power supply to the load or the load line before turning OFF the power supply to the sensor.

#### Mutual Interference Protection Function

Mutual interference prevention is enabled if Amplifier Units are connected together. It is also enabled in the same way if E3X-DA-S-series Units and E3C-LDA-series Units are used together.

## Mounting

### Connecting and Disconnecting Connectors

#### Mounting Connectors

1. Insert the Master or Slave connector into the Amplifier Unit until it clicks into place.

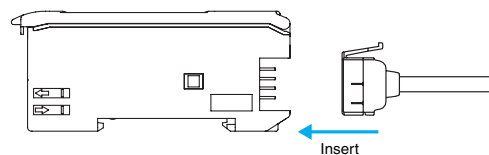

2. Attach the protective seals (provided as accessories) to the sides of master and slave connectors that are not connected.

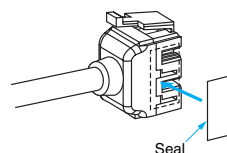

**Note:** Attach the seals to the sides with grooves.

#### Removing Connectors

1. Slide the slave Amplifier Unit away from the other unit.
2. After the Amplifier Unit has been separated, press down on the lever on the connector and remove it. (Do not attempt to remove a connector without first separating the Amplifier Unit from the other Units.)

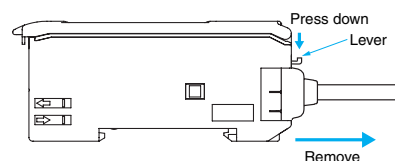

## Adding and Removing Amplifier Units

### Adding Amplifier Units

1. Mount the Amplifier Units one at a time onto the DIN track.

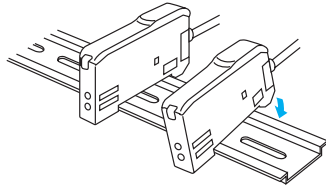

2. Slide the Amplifier Units together, line up the clips, and press the Amplifier Units together until they click into place.

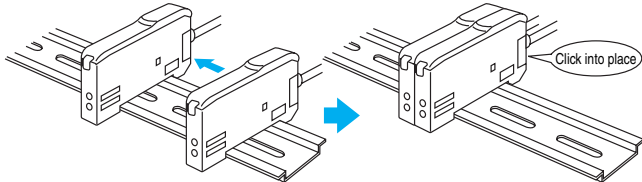

### Removing Amplifier Units

Slide Amplifier Units away from each other, and remove from the DIN track one at a time. (Do not attempt to remove Amplifier Units from the DIN track without separating them first.)

**Note: 1.** The specifications for ambient temperature will vary according to the number of Amplifier Units used together. For details, →refer to *Ambient temperature range* on page 4.  
**2.** Always turn OFF the power supply before joining or separating Amplifier Units.

### Mounting the End Plate (PFP-M)

Use an End Plate if the Amplifier Unit might move due to vibration.

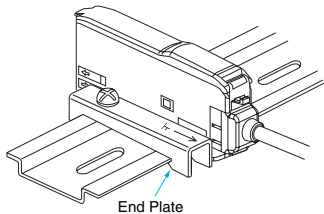

### Fiber Connection

The E3X Amplifier Unit has a lock lever for easy connection of the Fiber Unit. Connect or disconnect the fibers using the following procedures:

#### 1. Connecting Fibers

Open the protective cover, insert the fibers according to the fiber insertion marks on the side of the Amplifier Unit, and lower the lock lever.

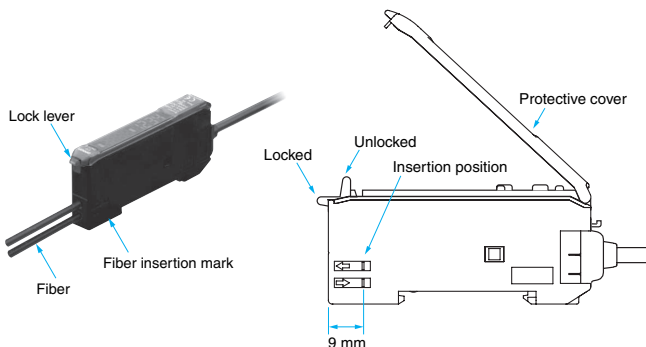

**Note:** Do not pull on the fiber, apply pressure on it, or otherwise subject it to excessive force when it is attached to the Amplifier Unit. (Use a force of 0.3 N·m max.)

### Fibers with E39-F9 Attachment

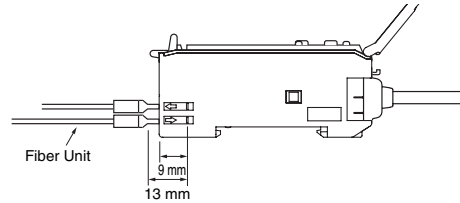

### Fibers That Cannot Be Free-Cut (with Sleeves)

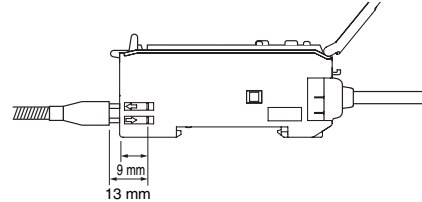

#### 2. Disconnecting Fibers

Remove the protective cover and raise the lock lever to pull out the fibers.

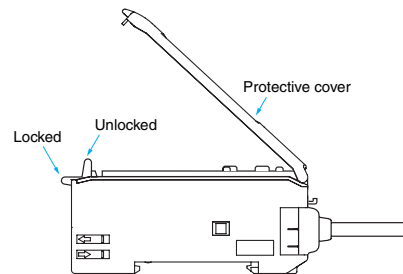

**Note: 1.** To maintain the fiber properties, confirm that the lock is released before removing the fibers.  
**2.** Be sure to lock or unlock the lock lever within an ambient temperature range between  $-10^{\circ}\text{C}$  and  $40^{\circ}\text{C}$ .

## Adjusting

### Mutual Interference Protection Function

The values that appear on the digital display may fluctuate somewhat due to light from other sensors. If this occurs, you can stabilize detection by setting a threshold that is close to half way between the incident levels with and without a sensing object.

### Output Short-circuits

OVER/CUR will flash on the display if the output short-circuit protection function operates due to a load short-circuit in a control output. If this occurs, check the load connections.

### EEPROM Writing Error

If the data is not written to the EEPROM correctly due to a power failure or static-electric noise, initialize the settings with the keys on the Amplifier Unit. ERR/EEP will flash on the display when a writing error has occurred.

### Optical Communications

Several Amplifier Units can be slid together and used in groups. Do not, however, slide the Amplifier Units or attempt to remove any of the Amplifier Units during operation.

## Others

### Protective Cover

Always keep the protective cover in place when using the Amplifier Unit.

### Mobile Console

The E3X-MC11-SV2 Mobile Console does not currently support the new Tough Mode and ON-delay + OFF-delay timer. You also cannot use the E3X-MC-S.

### Communications Unit

Use an E3X-DRT21-S Version 3 Communications Unit. This is not supported for the E3X-DA□R-S and E3X-DA□F-S (□: 21/51/7/9).



## Dimensions

Tolerance class IT16 applies to dimensions in this data sheet unless otherwise specified.

### Amplifier Units

#### Pre-wired Models

- E3X-DA21-S
- E3X-DA51-S
- E3X-DA21R-S
- E3X-DA51R-S
- E3X-DA21F-S
- E3X-DA51F-S

#### Digital Display Area

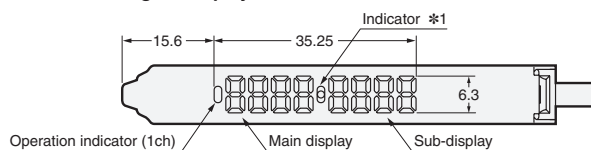

\*1. The indicators are as follows:

E3X-DA21-S	Operation indicator (2 ch)
E3X-DA51-S	APC alarm output indicator
E3X-DA21R-S	Power tuning indicator
E3X-DA51R-S	
E3X-DA21F-S	
E3X-DA51F-S	

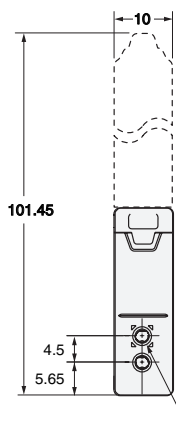

#### DIN track mounting

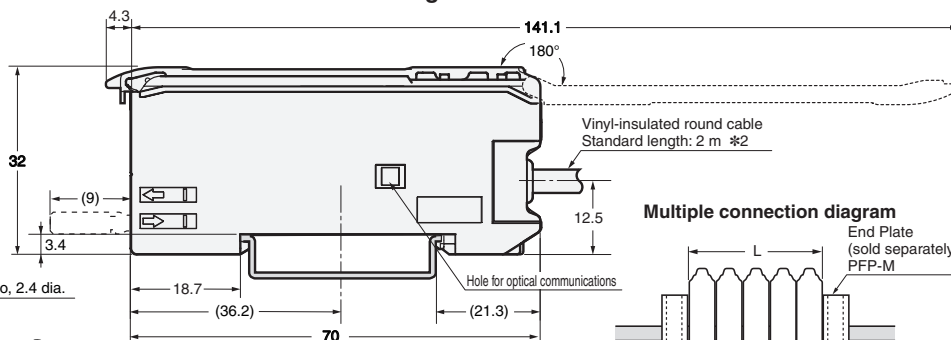

#### Multiple connection diagram

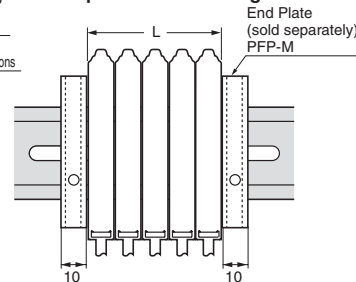

The number of expansion	L (mm)
1	10
2	20
3	30
4	40
5	50
6	60
7	70
8	80
9	90
10	100

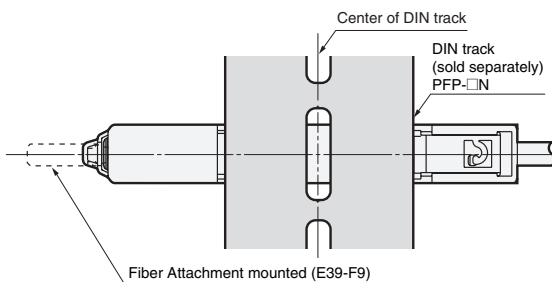

#### With Mounting Bracket Attached

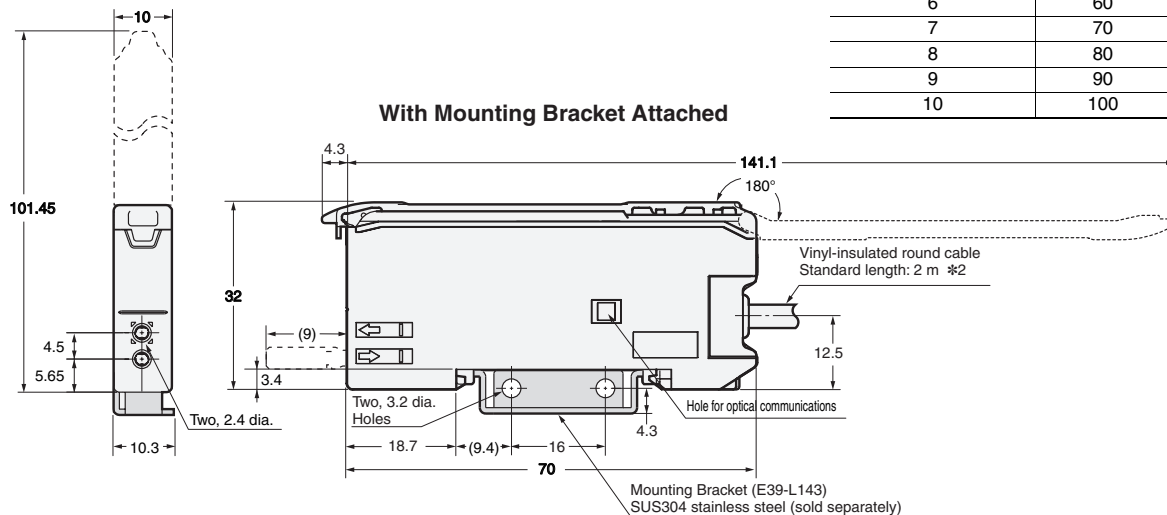

#### Mounting Holes

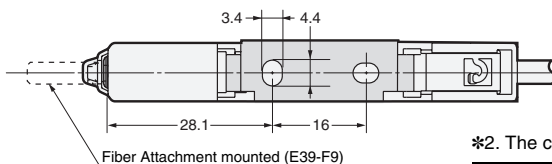
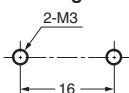

\*2. The cable specifications are as follows:

E3X-DA21-S	4 dia. cable / 5 conductors (Conductor cross section: 0.2 mm <sup>2</sup> , Insulator diameter: 1.1 mm)
E3X-DA51-S	
E3X-DA21R-S	
E3X-DA51R-S	
E3X-DA21F-S	4 dia. cable / 3 conductors (Conductor cross section: 0.2 mm <sup>2</sup> , Insulator diameter: 1.1 mm)
E3X-DA51F-S	

**Note:** When using E39-L143 Mounting Brackets, there will be small gaps between the Amplifier Units if they are mounted side by side.

# E3X-DA-S

## Wire-saving connector Models

- E3X-DA7-S
- E3X-DA9-S
- E3X-DA7R-S
- E3X-DA9R-S
- E3X-DA7F-S
- E3X-DA9F-S

### Digital Display Area

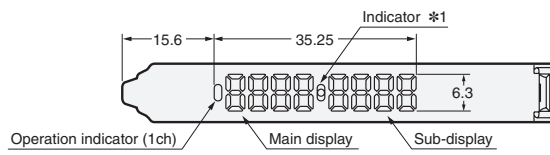

\*1. The indicators are as follows:

E3X-DA7-S E3X-DA9-S	Operation indicator (2 ch)
E3X-DA7R-S E3X-DA9R-S	APC alarm output indicator
E3X-DA7F-S E3X-DA9F-S	Power tuning indicator

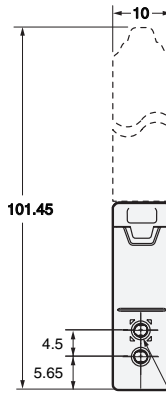

### DIN track mounting

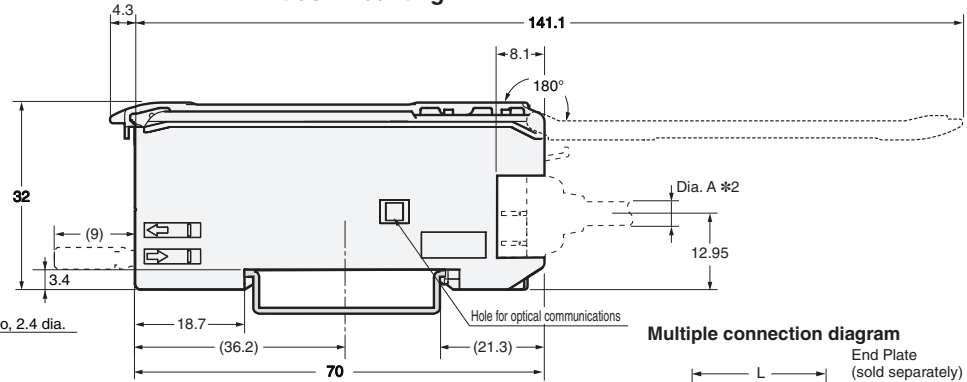

### Multiple connection diagram

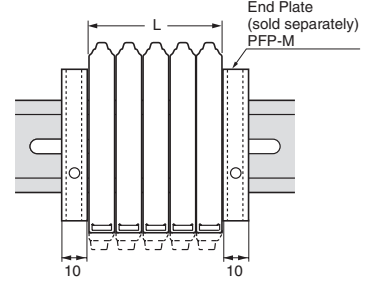

The number of expansion	L (mm)
1	10
2	20
3	30
4	40
5	50
6	60
7	70
8	80
9	90
10	100

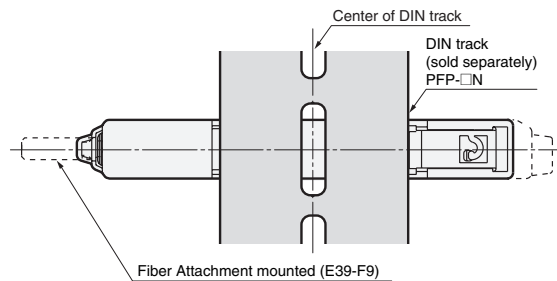

### With Mounting Bracket Attached

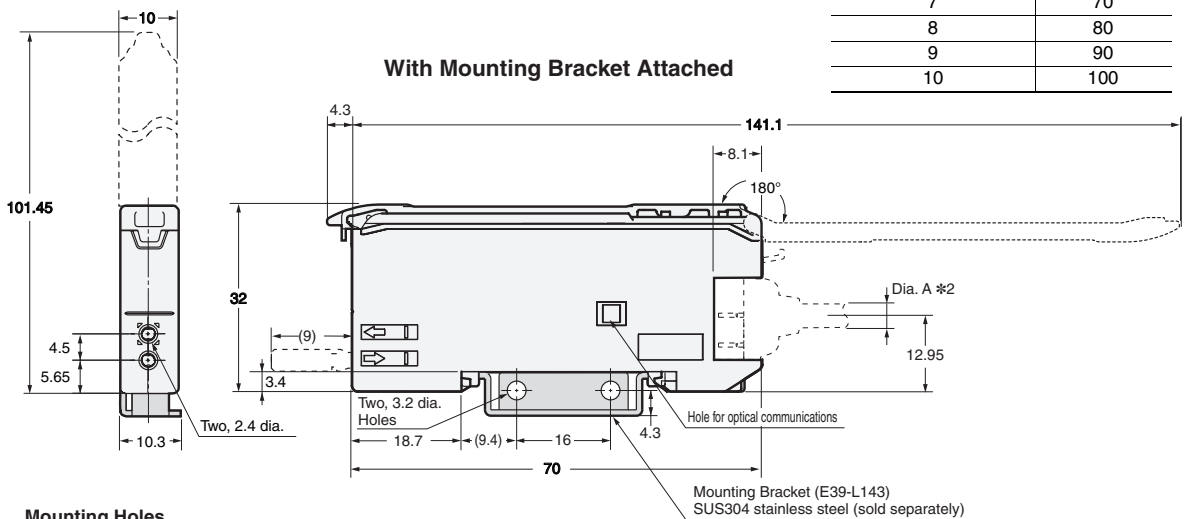

### Mounting Holes

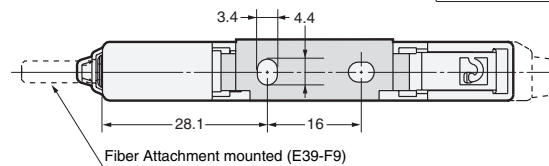
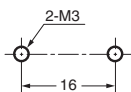

\*2. The cable diameters are as follows:

E3X-CN21 (4 conductors) E3X-CN22 (2 conductors) E3X-CN11 (3 conductors)	4.0 dia.
E3X-CN12 (1 conductor)	2.6 dia.

**Note:** When using E39-L143 Mounting Brackets, there will be small gaps between the Amplifier Units if they are mounted side by side.

## Wire-saving connector

### Master connector E3X-CN21

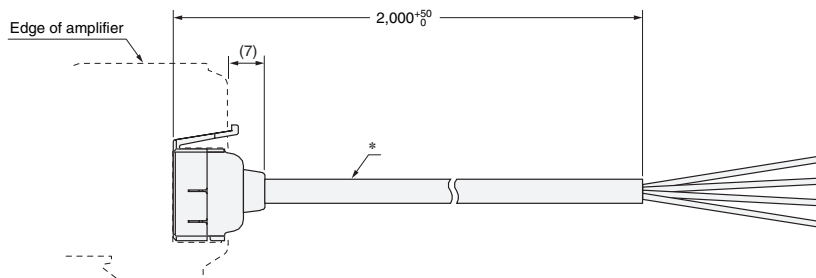

\* E3X-CN21: 4-dia. vinyl-insulated round cable with 4 conductors (Conductor cross section: 0.2 mm<sup>2</sup>, Insulator diameter: 1.1 mm)

### Slave connector E3X-CN22

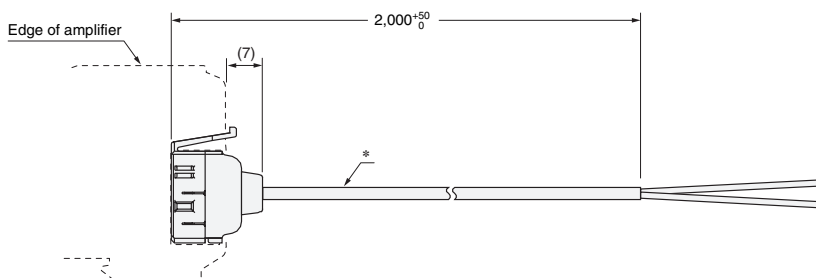
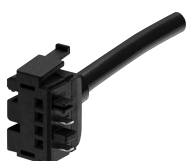

\* E3X-CN22: 4-dia. vinyl-insulated round cable with 2 conductors (Conductor cross section: 0.2 mm<sup>2</sup>, Insulator diameter: 1.1 mm)

### Master connector E3X-CN11

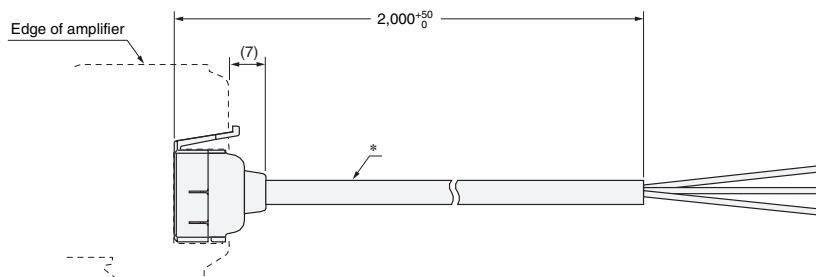
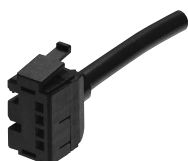

\* Cable 4-dia. vinyl-insulated round cable with 3 conductors (Conductor cross section: 0.2 mm<sup>2</sup>, Insulator diameter: 1.1 mm)

### Slave connector E3X-CN12

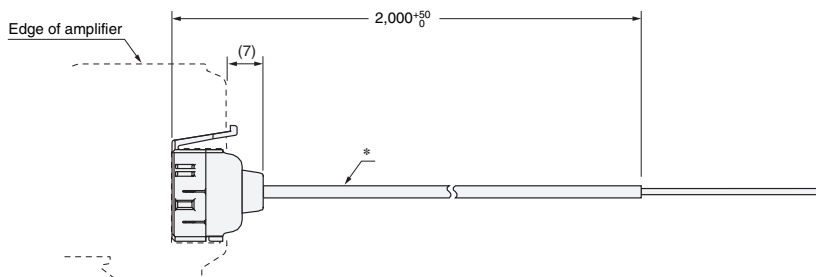
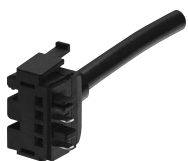

\* Cable 2.6-dia. vinyl-insulated round cable with 1 conductors (Conductor cross section: 0.2 mm<sup>2</sup>, Insulator diameter: 1.1 mm)



# Terms and Conditions of Sale

1. **Offer; Acceptance.** These terms and conditions (these "**Terms**") are deemed part of all quotes, agreements, purchase orders, acknowledgments, price lists, catalogs, manuals, brochures and other documents, whether electronic or in writing, relating to the sale of products or services (collectively, the "**Products**") by Omron Electronics LLC and its subsidiary companies ("**Omron**"). Omron objects to any terms or conditions proposed in Buyer's purchase order or other documents which are inconsistent with, or in addition to, these Terms.
2. **Prices; Payment Terms.** All prices stated are current, subject to change without notice by Omron. Omron reserves the right to increase or decrease prices on any unshipped portions of outstanding orders. Payments for Products are due net 30 days unless otherwise stated in the invoice.
3. **Discounts.** Cash discounts, if any, will apply only on the net amount of invoices sent to Buyer after deducting transportation charges, taxes and duties, and will be allowed only if (i) the invoice is paid according to Omron's payment terms and (ii) Buyer has no past due amounts.
4. **Interest.** Omron, at its option, may charge Buyer 1-1/2% interest per month or the maximum legal rate, whichever is less, on any balance not paid within the stated terms.
5. **Orders.** Omron will accept no order less than \$200 net billing.
6. **Governmental Approvals.** Buyer shall be responsible for, and shall bear all costs involved in, obtaining any government approvals required for the importation or sale of the Products.
7. **Taxes.** All taxes, duties and other governmental charges (other than general real property and income taxes), including any interest or penalties thereon, imposed directly or indirectly on Omron or required to be collected directly or indirectly by Omron for the manufacture, production, sale, delivery, importation, consumption or use of the Products sold hereunder (including customs duties and sales, excise, use, turnover and license taxes) shall be charged to and remitted by Buyer to Omron.
8. **Financial.** If the financial position of Buyer at any time becomes unsatisfactory to Omron, Omron reserves the right to stop shipments or require satisfactory security or payment in advance. If Buyer fails to make payment or otherwise comply with these Terms or any related agreement, Omron may (without liability and in addition to other remedies) cancel any unshipped portion of Products sold hereunder and stop any Products in transit until Buyer pays all amounts, including amounts payable hereunder, whether or not then due, which are owing to it by Buyer. Buyer shall in any event remain liable for all unpaid accounts.
9. **Cancellation; Etc.** Orders are not subject to rescheduling or cancellation unless Buyer indemnifies Omron against all related costs or expenses.
10. **Force Majeure.** Omron shall not be liable for any delay or failure in delivery resulting from causes beyond its control, including earthquakes, fires, floods, strikes or other labor disputes, shortage of labor or materials, accidents to machinery, acts of sabotage, riots, delay in or lack of transportation or the requirements of any government authority.
11. **Shipping; Delivery.** Unless otherwise expressly agreed in writing by Omron:
  - a. Shipments shall be by a carrier selected by Omron; Omron will not drop ship except in "break down" situations.
  - b. Such carrier shall act as the agent of Buyer and delivery to such carrier shall constitute delivery to Buyer;
  - c. All sales and shipments of Products shall be FOB shipping point (unless otherwise stated in writing by Omron), at which point title and risk of loss shall pass from Omron to Buyer; provided that Omron shall retain a security interest in the Products until the full purchase price is paid;
  - d. Delivery and shipping dates are estimates only; and
  - e. Omron will package Products as it deems proper for protection against normal handling and extra charges apply to special conditions.
12. **Claims.** Any claim by Buyer against Omron for shortage or damage to the Products occurring before delivery to the carrier must be presented in writing to Omron within 30 days of receipt of shipment and include the original transportation bill signed by the carrier noting that the carrier received the Products from Omron in the condition claimed.
13. **Warranties.** (a) **Exclusive Warranty.** Omron's exclusive warranty is that the Products will be free from defects in materials and workmanship for a period of twelve months from the date of sale by Omron (or such other period expressed in writing by Omron). Omron disclaims all other warranties, express or implied. (b) **Limitations.** OMRON MAKES NO WARRANTY OR REPRESENTATION, EXPRESS OR IMPLIED, ABOUT NON-INFRINGEMENT, MERCHANTABILITY OR FITNESS FOR A PARTICULAR PURPOSE OF THE PRODUCTS. BUYER ACKNOWLEDGES THAT IT ALONE HAS DETERMINED THAT THE PRODUCTS WILL SUITABLY MEET THE REQUIREMENTS OF THEIR INTENDED USE. Omron further disclaims all warranties and responsibility of any type for claims or expenses based on infringement by the Products or otherwise of any intellectual property right. (c) **Buyer Remedy.** Omron's sole obligation hereunder shall be, at Omron's election, to (i) replace (in the form originally shipped with Buyer responsible for labor charges for removal or replacement thereof) the non-complying Product, (ii) repair the non-complying Product, or (iii) repay or credit Buyer an amount equal to the purchase price of the non-complying Product; provided that in no event shall Omron be responsible for warranty, repair, indemnity or any other claims or expenses regarding the Products unless Omron's analysis confirms that the Products were properly handled, stored, installed and maintained and not subject to contamination, abuse, misuse or inappropriate modification. Return of any Products by Buyer must be approved in writing by Omron before shipment. Omron Companies shall not be liable for the suitability or unsuitability or the results from the use of Products in combination with any electrical or electronic components, circuits, system assemblies or any other materials or substances or environments. Any advice, recommendations or information given orally or in writing, are not to be construed as an amendment or addition to the above warranty. See <http://www.omron247.com> or contact your Omron representative for published information.
14. **Limitation on Liability; Etc.** OMRON COMPANIES SHALL NOT BE LIABLE FOR SPECIAL, INDIRECT, INCIDENTAL, OR CONSEQUENTIAL DAMAGES, LOSS OF PROFITS OR PRODUCTION OR COMMERCIAL LOSS IN ANY WAY CONNECTED WITH THE PRODUCTS, WHETHER SUCH CLAIM IS BASED IN CONTRACT, WARRANTY, NEGLIGENCE OR STRICT LIABILITY. Further, in no event shall liability of Omron Companies exceed the individual price of the Product on which liability is asserted.
15. **Indemnities.** Buyer shall indemnify and hold harmless Omron Companies and their employees from and against all liabilities, losses, claims, costs and expenses (including attorney's fees and expenses) related to any claim, investigation, litigation or proceeding (whether or not Omron is a party) which arises or is alleged to arise from Buyer's acts or omissions under these Terms or in any way with respect to the Products. Without limiting the foregoing, Buyer (at its own expense) shall indemnify and hold harmless Omron and defend or settle any action brought against such Companies to the extent based on a claim that any Product made to Buyer specifications infringed intellectual property rights of another party.
16. **Property; Confidentiality.** Any intellectual property in the Products is the exclusive property of Omron Companies and Buyer shall not attempt to duplicate it in any way without the written permission of Omron. Notwithstanding any charges to Buyer for engineering or tooling, all engineering and tooling shall remain the exclusive property of Omron. All information and materials supplied by Omron to Buyer relating to the Products are confidential and proprietary, and Buyer shall limit distribution thereof to its trusted employees and strictly prevent disclosure to any third party.
17. **Export Controls.** Buyer shall comply with all applicable laws, regulations and licenses regarding (i) export of products or information; (ii) sale of products to "forbidden" or other proscribed persons; and (iii) disclosure to non-citizens of regulated technology or information.
18. **Miscellaneous.** (a) **Waiver.** No failure or delay by Omron in exercising any right and no course of dealing between Buyer and Omron shall operate as a waiver of rights by Omron. (b) **Assignment.** Buyer may not assign its rights hereunder without Omron's written consent. (c) **Law.** These Terms are governed by the law of the jurisdiction of the home office of the Omron company from which Buyer is purchasing the Products (without regard to conflict of law principles). (d) **Amendment.** These Terms constitute the entire agreement between Buyer and Omron relating to the Products, and no provision may be changed or waived unless in writing signed by the parties. (e) **Severability.** If any provision hereof is rendered ineffective or invalid, such provision shall not invalidate any other provision. (f) **Setoff.** Buyer shall have no right to set off any amounts against the amount owing in respect of this invoice. (g) **Definitions.** As used herein, "including" means "including without limitation"; and "Omron Companies" (or similar words) mean Omron Corporation and any direct or indirect subsidiary or affiliate thereof.

## Certain Precautions on Specifications and Use

1. **Suitability of Use.** Omron Companies shall not be responsible for conformity with any standards, codes or regulations which apply to the combination of the Product in the Buyer's application or use of the Product. At Buyer's request, Omron will provide applicable third party certification documents identifying ratings and limitations of use which apply to the Product. This information by itself is not sufficient for a complete determination of the suitability of the Product in combination with the end product, machine, system, or other application or use. Buyer shall be solely responsible for determining appropriateness of the particular Product with respect to Buyer's application, product or system. Buyer shall take application responsibility in all cases but the following is a non-exhaustive list of applications for which particular attention must be given: (i) Outdoor use, uses involving potential chemical contamination or electrical interference, or conditions or uses not described in this document. (ii) Use in consumer products or any use in significant quantities. (iii) Energy control systems, combustion systems, railroad systems, aviation systems, medical equipment, amusement machines, vehicles, safety equipment, and installations subject to separate industry or government regulations. (iv) Systems, machines and equipment that could present a risk to life or property. Please know and observe all prohibitions of use applicable to this Product. NEVER USE THE PRODUCT FOR AN APPLICATION INVOLVING SERIOUS RISK TO LIFE OR PROPERTY OR IN LARGE QUANTITIES WITHOUT ENSURING THAT THE SYSTEM AS A WHOLE HAS BEEN DESIGNED TO ADDRESS THE RISKS, AND THAT THE OMRON'S PRODUCT IS PROPERLY RATED AND INSTALLED FOR THE INTENDED USE WITHIN THE OVERALL EQUIPMENT OR SYSTEM.
2. **Programmable Products.** Omron Companies shall not be responsible for the user's programming of a programmable Product, or any consequence thereof.
3. **Performance Data.** Data presented in Omron Company websites, catalogs and other materials is provided as a guide for the user in determining suitability and does not constitute a warranty. It may represent the result of Omron's test conditions, and the user must correlate it to actual application requirements. Actual performance is subject to the Omron's Warranty and Limitations of Liability.
4. **Change in Specifications.** Product specifications and accessories may be changed at any time based on improvements and other reasons. It is our practice to change part numbers when published ratings or features are changed, or when significant construction changes are made. However, some specifications of the Product may be changed without any notice. When in doubt, special part numbers may be assigned to fix or establish key specifications for your application. Please consult with your Omron's representative at any time to confirm actual specifications of purchased Product.
5. **Errors and Omissions.** Information presented by Omron Companies has been checked and is believed to be accurate; however, no responsibility is assumed for clerical, typographical or proofreading errors or omissions.

OMRON INDUSTRIAL AUTOMATION • THE AMERICAS HEADQUARTERS • Schaumburg, IL USA • 847.843.7900 • 800.556.6766 • www.omron247.com

**OMRON CANADA, INC. • HEAD OFFICE**

Toronto, ON, Canada • 416.286.6465 • 866.986.6766 • www.omron247.com

**OMRON ELECTRONICS DE MEXICO • HEAD OFFICE**

México DF • 52.55.59.01.43.00 • 001.800.556.6766 • mela@omron.com

**OMRON ELECTRONICS DE MEXICO • SALES OFFICE**

Apodaca, N.L. • 52.81.11.56.99.20 • 001.800.556.6766 • mela@omron.com

**OMRON ELETRÔNICA DO BRASIL LTDA • HEAD OFFICE**

São Paulo, SP, Brasil • 55.11.2101.6300 • www.omron.com.br

**OMRON ARGENTINA • SALES OFFICE**

Cono Sur • 54.11.4783.5300

**OMRON CHILE • SALES OFFICE**

Santiago • 56.9.9917.3920

**OTHER OMRON LATIN AMERICA SALES**

54.11.4783.5300

OMRON EUROPE B.V. • Wegalaan 67-69, NL-2132 JD, Hoofddorp, The Netherlands. • Tel: +31 (0) 23 568 13 00 • Fax: +31 (0) 23 568 13 88 • www.industrial.omron.eu

*Authorized Distributor:*

**Automation Systems**

- Programmable logic controllers (PLC) • Human machine interfaces (HMI) • Remote I/O
- Industrial PC's • Software

**Motion & Drives**

- Motion controllers • Servo systems • AC drives

**Control Components**

- Temperature controllers • Power supplies • Timers • Counters • Programmable relays
- Digital panel indicators • Electromechanical relays • Monitoring products • Solid-state relays
- Limit switches • Pushbutton switches • Low voltage switch gear

**Sensing & Safety**

- Photoelectric sensors • Inductive sensors • Capacitive & pressure sensors
- Cable connectors • Displacement & width-measuring sensors • Vision systems
- Safety networks • Safety sensors • Safety units/relay units • Safety door/guard lock switches